

Amphenol FCI
 2016 AFCl
 ©
 D

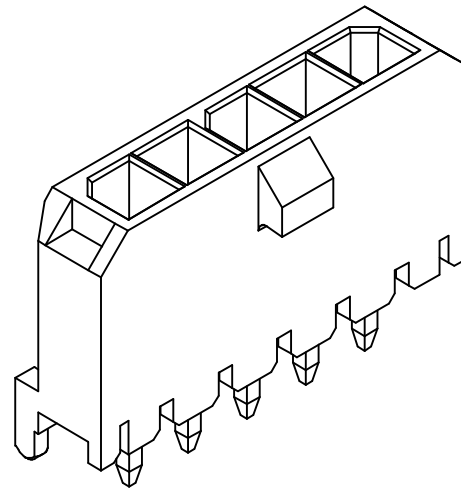
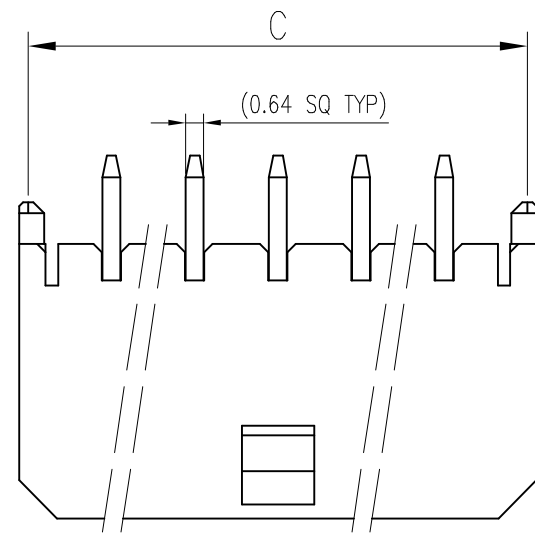

- NOTE:
- MATERIAL:
HOUSING: LCP, UL94V-0, HALOGEN FREE, COLOR: OPTION
CONTACT: COPPER ALLOY.
 - CONTACT FINISH: NICKEL 50u" Min. UNDERPLATED OVERALL.
OPTIONAL PLATING ON CONTACT AREA, TIN ON SOLDER TAIL.
 - REFER GS-20-0399 APPLICATION SPECIFICATION FOR MATING CONNECTOR.
 - PRODUCT SPECIFICATION: GS-12-1177.
 - PACKAGE SPECIFICATION: GS-14-2359.
 - APPLICATION SPECIFICATION: GS-20-0399
 - THE HOUSING WILL WITHSTAND EXPOSURE TO 260°C PEAK TEMPERATURE FOR 10 SECONDS IN A REFLOW OVEN.
 - THE HOUSING WILL WITHSTAND EXPOSURE TO 260°C PEAK TEMPERATURE FOR 5 SECONDS IN A WAVE SOLDER
 - LEAD FREE PRODUCTS MEET EUROPEAN UNION DIRECTIVES AND OTHER COUNTRY REGULATIONS AS DESCRIBED IN GS-47-0004
 - PART NUMBER SCHEME:
10136656- XX X X X X LF

POS. CODE: _____

02: 2 POS
03: 4 POS
 }
12: 12 POS

LEAD FREE
PACKAGE:
BLANK: TRAY
T: TAPE & REEL
HOUSING COLOR:
BLANK: BLACK
N: NATURAL
GLOW WIRE COMPATIBLE:
1: COMPATIBLE
2: NON-COMPATIBLE

PLATING CODE: _____

- 100u" Min. MATTE TIN OVERALL
- GOLD FLASH ON CONTACT AREA, 100u" MATTE TIN ON SOLDER TAIL
- 15u" Min Au ON CONTACT AREA, 100u" Min MATTE TIN ON TAIL
- 30u" Au ON CONTACT AREA, 100u" Min MATTE TIN ON TAIL

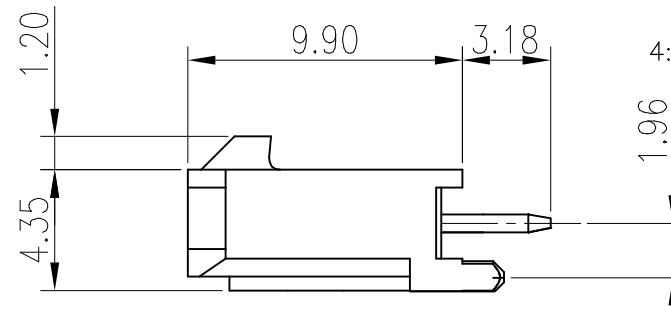
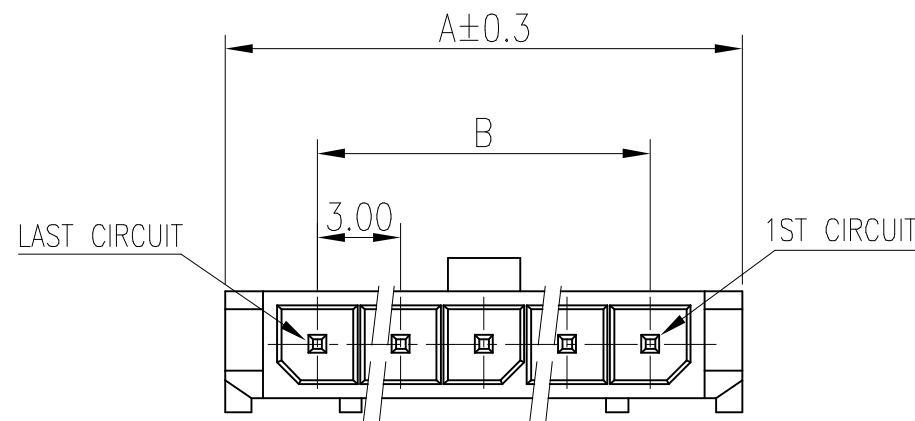

PART NO.	POS.	A	B	C
10136656-02XXXXLF	02	9.65	3.0	9.0
10136656-03XXXXLF	03	12.65	6.0	12.0
10136656-04XXXXLF	04	15.65	9.0	15.0
10136656-05XXXXLF	05	18.65	12.0	18.0
10136656-06XXXXLF	06	21.65	15.0	21.0
10136656-07XXXXLF	07	24.65	18.0	24.0
10136656-08XXXXLF	08	27.65	21.0	27.0
10136656-09XXXXLF	09	30.65	24.0	30.0
10136656-10XXXXLF	10	33.65	27.0	33.0
10136656-11XXXXLF	11	36.65	30.0	36.0
10136656-12XXXXLF	12	39.65	33.0	39.0

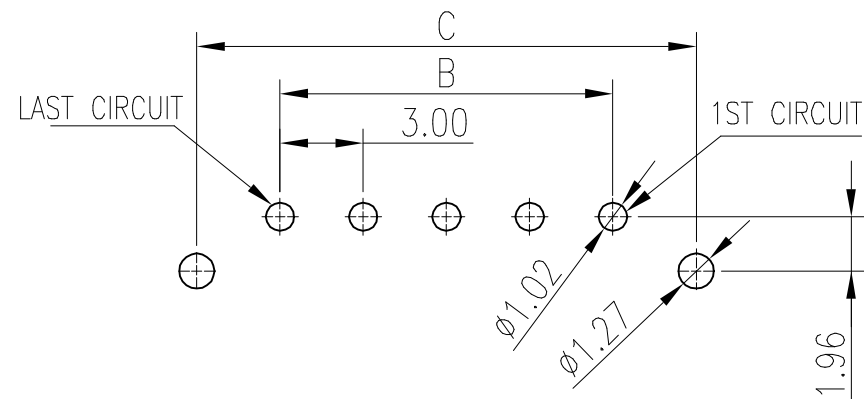

RECOMMENDED PCB LAYOUT: COMPONENT SIDE
THICKNESS: 1.60±0.05mm
(GENERAL TOLERANCE: ±0.05)

mat'l. code		surface ISO 1302 ✓		tolerance ISO 406 ISO 1101		projection		product family	
ltr		ecn no		dr		date		MINITEK PWR3.0	
A		ELX-N-28267		TAI		2015-09-23		title	
B		ELX-N-28267		TONY		2017-10-26		MINITEK PWR3.0 VERTICAL	
C		ELX-I-43460		AKHIL		2022-01-21		HEADER, SINGLE ROW, THROUGH	
sheet index		revision sheet		C		C		dwg no	
1		1		1		2		sheet 1 of 2	
				KENNY TAI		2015-08-21		size	
				AKHIL RAJAN		2022-01-21		A3	
				MITHUN PAUL		2022-01-21		10136656	
				SPK		2022-01-21		Product Customer Drawing	

Amphenol
FCi

© 2016 AFci

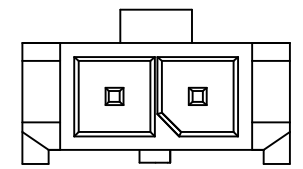

2 POS

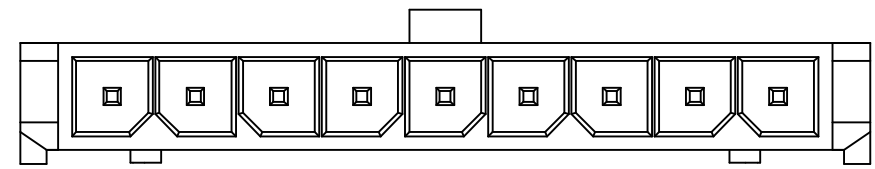

9 POS

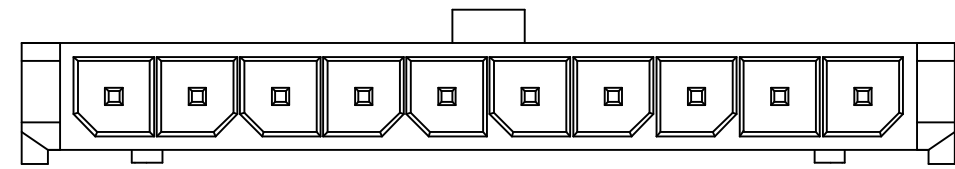

10 POS

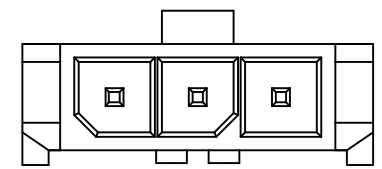

3 POS

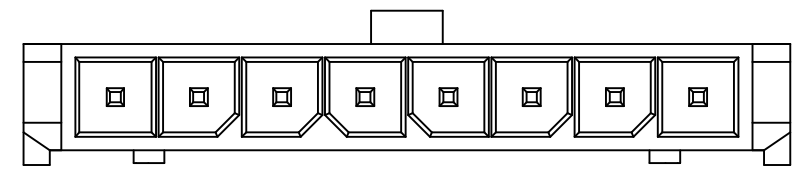

8 POS

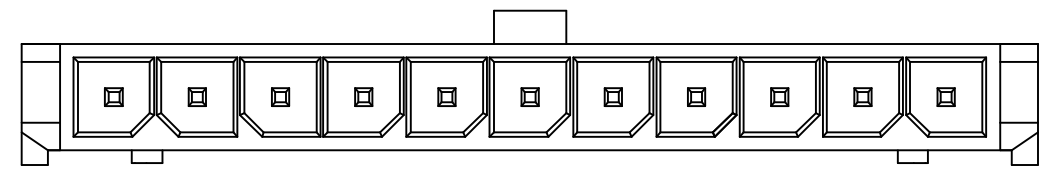

11 POS

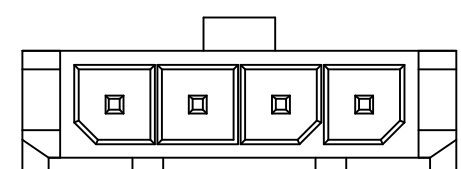

4 POS

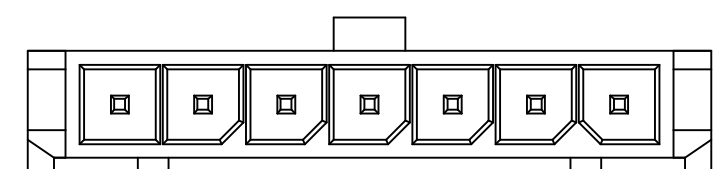

7 POS

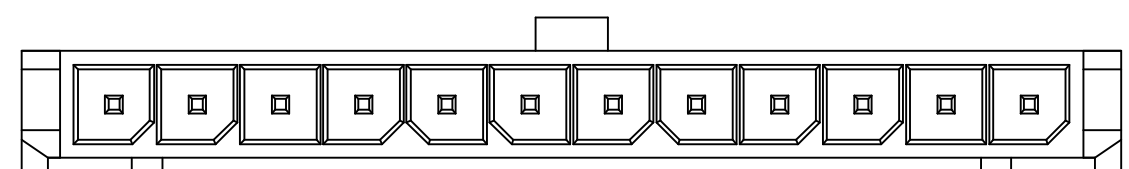

12 POS

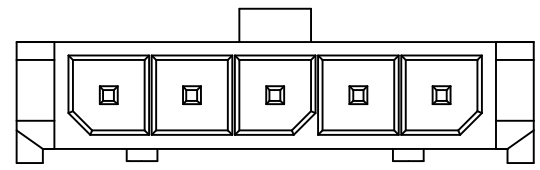

5 POS

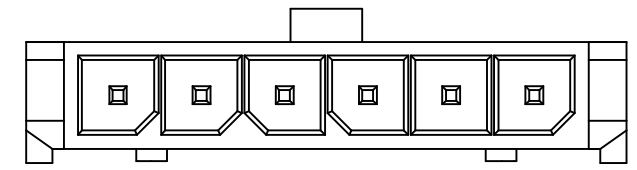

6 POS

mat'l. code		surface		tolerance		projection		product family	
		ISO 1302		ISO 406 ISO 1101				MINITEK PWR3.0	
ltr		ecn no		dr		date		title	
								MINITEK PWR3.0 VERTICAL HEADER, SINGLE ROW, THROUGH	
				angles		linear		scale	
				0°±2'				N.T.S	
				dr		KENNY TAI		2015-08-21	
				enr		AKHIL RAJAN		2022-01-21	
				chr		MITHUN PAUL		2022-01-21	
				app		SPK		2022-01-21	
sheet index		revision sheet		C		C		dwg no	
		1 2						sheet 2 of 2	
								size	
								A3	
								type	
								Product Customer Drawing	

X-ON Electronics

Largest Supplier of Electrical and Electronic Components

Click to view similar products for [Headers & Wire Housings](#) category:

Click to view products by [Amphenol](#) manufacturer:

Other Similar products are found below :

[0015917161](#) [0022155065](#) [57102-F02-18ULF](#) [58102-G61-06LF](#) [582553-1](#) [01.001.5753.1](#) [0050291907](#) [02.125.8002.8](#) [609-3404](#) [61062-3](#)
[CSU011177004](#) [622-0430](#) [622-3653LF](#) [63453-116](#) [636-1030](#) [636-1427](#) [636-3427](#) [636-4007](#) [641938-9](#) [65495-038](#) [65692-001LF](#) [65781-018](#)
[65781-047](#) [65817-010LF](#) [65817-015LF](#) [67095-007LF](#) [67601157](#) [68631-112](#) [699319-000](#) [70.362.1628.0](#) [70-4210](#) [70-4226B](#) [70-4853B](#) [707-](#)
[5028](#) [71.350.2428.0](#) [733-134](#) [733-162](#) [760-3052](#) [MHR-64-VUAL](#) [80.063.4001.1](#) [800-90-001-10-001000](#) [801-43-002-10-013000](#)
[801-43-006-10-002000](#) [803-43-024-10-001000](#) [803-93-012-10-001000](#) [8-1437020-4](#) [819-22-004-30-001101](#) [820-22-006-30-001101](#)
[820-22-008-30-001101](#) [821-22-002-10-001101](#)