

# Amphenol®



## **AC and SAE AS50151** Threaded Standard Cylindrical Connectors

**Amphenol® AC Series Connectors**

Introduction/General Information ..... 1

    AC Threaded Connector Styles

        Wall mounting receptacle ..... 2

        Line receptacle ..... 3

        Box mounting receptacle ..... 4

        Straight plug ..... 5

        90 degree plug ..... 6

    AC Series how to order ..... 59

**Amphenol® SAE AS50151 Standard Cylindrical Connectors**

General Information, Class Designations ..... 7

    MS-A, MS-C General Information ..... 8

        MS3100A or C wall mounting receptacle ..... 9

        MS3101A inline receptacle ..... 10

        MS3102A or C box mounting receptacle ..... 11

        MS3106A straight plug ..... 12

        MS3108A 90 degree plug ..... 13

    MS-E/F General Information ..... 14

        MS3100E/F wall mounting receptacle ..... 15

        MS3101E/F inline receptacle ..... 16

        MS3102E box mounting receptacle ..... 17

        MS3106E/F straight plug ..... 18

        MS3108E 90 degree plug ..... 19

    MS-R General Information ..... 20

        MS3100R wall mounting receptacle ..... 21

        MS3101R inline receptacle ..... 22

        MS3102R box mounting receptacle ..... 23

        MS3106R straight plug ..... 24

    MS/Standard How to Order ..... 60

**Amphenol AC Threaded/ SAE AS50151 Insert Arrangements, Contacts and Accessories**

AC Series/MS insert availability ..... 25-27

AC Series/MS insert alternate positioning ..... 28

AC Series/MS solder contacts ..... 29

AC Series crimp contacts ..... 30

RADSOK® technology and crimp socket contacts ..... 31

AC Series/MS contact arrangements ..... 32-53

AC Series thermocouple availability ..... 54

AC Series thermocouple contact arrangements ..... 55 – 58

AC Series/MS accessories – sealing gaskets, sealing plugs, sealing ranges ..... 61

MS3057A cable clamp, MS3420 sleeve ..... 62

Plug protection caps ..... 63

Receptacle protection caps ..... 64

Dust caps ..... 65

AC Series/MS application tools, torque values ..... 66

Reverse Bayonet Coupling 5015 type connectors ..... 67

AC Series Threaded Connectors with RADSOK® Contacts ..... 68

Amphe-Power® 5015 Connectors (AC threaded series with high amperage RADSOK® contacts),  
5015 Connectors with PCB contacts ..... 68

For additional information on AC Series or SAE AS50151 Connectors for special application requirements, contact your local sales office or –

**Amphenol Corporation**  
**Amphenol Industrial Operations**  
 191 Delaware Avenue  
 Sidney, New York 13838-1395  
 Telephone: 888-364-9011 Fax: 520-397-7169  
 www.amphenol-industrial.com

Ask for the Amphenol Industrial North American Product Overview for additional connectors offered.

For specific questions about RoHS compliance, consult Amphenol Industrial Operations, or call the RoHS Product Compliance and Technical Support line: 1-866-315-8559

This catalog can be viewed, printed and saved from website: [www.amphenol-industrial.com](http://www.amphenol-industrial.com).

Amphenol Industrial is a Certified ISO 9001 Manufacturer.

# Amphenol® AC Series

## industrial application threaded style connector

### AC Threaded Series

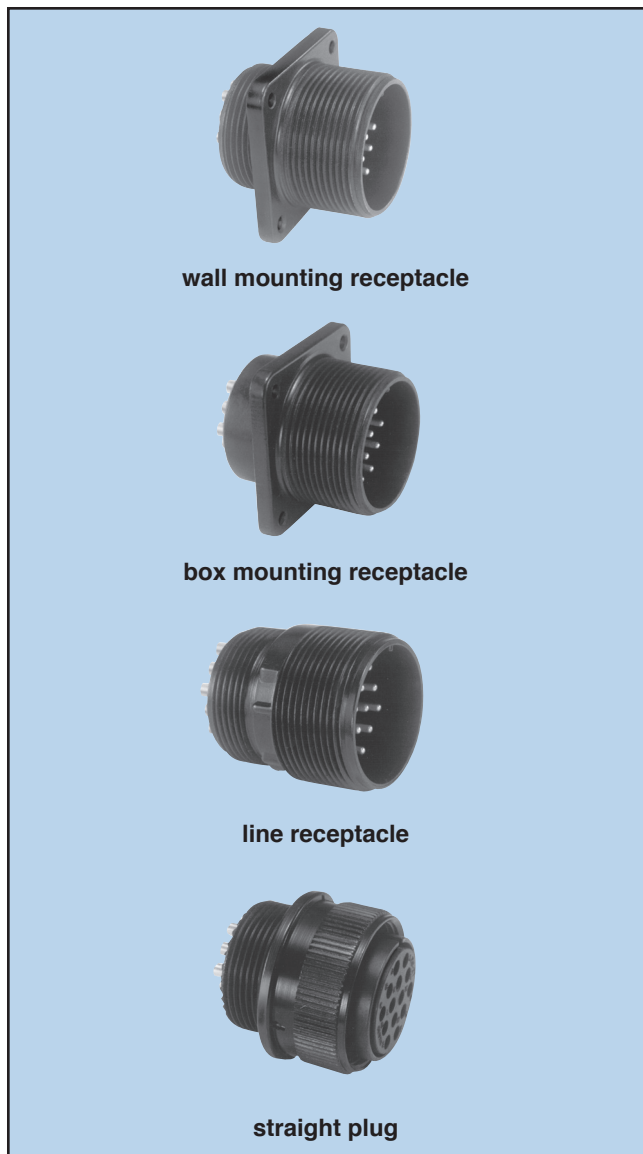

wall mounting receptacle

box mounting receptacle

line receptacle

straight plug

### AC Threaded Connectors with RADSOK® High Amperage Contacts



Designed with the industrial user in mind, for widely diverse applications such as mass transportation, automotive, heavy equipment and geophysical industries, and for the entertainment/ lighting industries, the new AC Series of Connectors offer the following features:

- Rugged aluminum shells
- Durability and reliability
- Environmentally acceptable shell plating options -
  - Conductive and non-conductive
- Single key/keyway shell polarization
- Five shell styles in sizes 10SL to 40
- Threaded coupling
- Various backshells
- Resilient inserts -
  - Outstanding moisture barrier
  - High dielectric strength
  - High resistance to vibration
- Over 275 insert patterns available
- Alternate insert positioning
- Machined contacts -
  - Maximum corrosion resistance
  - Maximum current capacity
  - Low millivolt drop
- Solder and crimp contacts - silver plated or optional gold plating
- General duty and environmental versions
- -55° C to +125° C operating temp. range
- Standard application tools

**Amphe-Power™ Connectors - AC Threaded Connectors with RADSOK® contacts are also available. These are high amperage capability connectors designed for the most demanding industrial and transportation applications.**

- The RADSOK contact will handle 50% to 150% higher amperages than standard contacts (size dependent).
  - Current Amphe-Power lines support from 35A to 500A continuous duty.
  - RADSOK contacts are available in size 12 (35 amps), size 8 (70 amps), size 4 (120 amps), and size 0 (250 amps).
- See page 31 for more information.

**Note:** The previous AC-B Bayonet series is replaced by the newer ACA-B Reverse Bayonet series. For availability of the AC-B, consult Amphenol Industrial Operations. For information on ACA-B Reverse Bayonet series connectors see Amphenol catalog IC-4.



RoHS Compliant options available.

# AC Threaded wall mounting receptacle

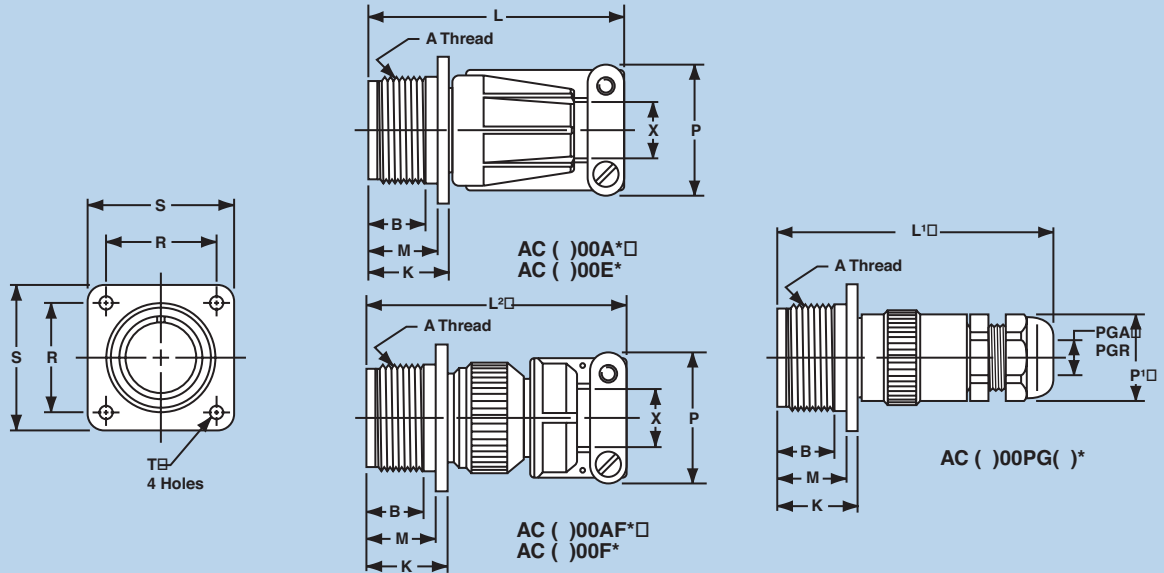

\* To complete order number, see how to order, page 59.

Inches

Shell Size	A Thread Class 2A	B Min Full Thread	K +.020 - .010	L Max	L <sup>1</sup> Max	L <sup>2</sup> Max	M +.010 - .000	P Max	P <sup>1</sup> Hex Flats Ref	PGA Ref	PGR Ref	R ±.005	S ±.010	T Dia +.004 - .002	X Max O.D. Cable
10SL	.6250-24UNEF	.391	.672	2.129	3.010	2.189	.562	.894	.750	.150/.320	.070/.240	.719	1.000	.120	.312
12S	.7500-20UNEF	.450	.672	2.129	3.010	2.261	.562	.894	.750	.150/.320	.070/.240	.812	1.094	.120	.312
12	.7500-20UNEF	.625	.860	2.524	3.500	2.644	.750	.894	.750	.150/.320	.070/.240	.812	1.094	.120	.312
14S	.8750-20UNEF	.450	.672	2.201	3.188	2.261	.562	1.083	.880	.190/.390	.110/.280	.906	1.188	.120	.438
14	.8750-20UNEF	.625	.860	2.524	3.641	2.644	.750	1.083	.880	.190/.390	.110/.280	.906	1.188	.120	.438
16S	1.0000-20UNEF	.450	.672	2.201	3.265	2.266	.562	1.181	.940	.230/.470	.190/.350	.969	1.281	.120	.531
16	1.0000-20UNEF	.625	.860	2.524	3.718	2.644	.750	1.181	.940	.230/.470	.190/.350	.969	1.281	.120	.531
18	1.1250-18UNEF	.625	.891	2.596	3.718	2.716	.750	1.300	.940	.230/.470	.190/.350	1.063	1.375	.120	.625
20	1.2500-18UNEF	.625	.891	2.654	3.798	2.774	.750	1.487	1.060	.390/.560	.270/.470	1.156	1.500	.120	.750
22	1.3750-18UNEF	.625	.891	2.654	4.080	2.916	.750	1.487	1.060	.390/.560	.270/.470	1.250	1.625	.120	.750
24	1.5000-18UNEF	.625	.953	2.885	4.142	3.051	.812	1.712	1.060	.390/.560	.270/.470	1.375	1.750	.147	.938
28	1.7500-18UNS	.625	.953	2.885	4.291	3.140	.812	1.712	1.300	.510/.710	.350/.630	1.562	2.000	.147	.938
32	2.0000-18UNS	.625	1.031	2.943	4.643	3.184	.875	2.063	1.650	.700/.980	.510/.790	1.750	2.250	.173	1.250
36	2.2500-16UN	.625	1.031	2.943	4.643	3.245	.875	2.283	1.650	.700/.980	.510/.790	1.938	2.500	.173	1.375
40	2.5000-16UN	.625	1.031	3.068	5.635	3.670	.875	2.688	1.650	.700/.980	.510/.790	2.188	2.750	.173	1.625

Millimeters

Shell Size	B Min Full Thread	K +.51 - .25	L Max	L <sup>1</sup> Max	L <sup>2</sup> Max	M +.25 - .00	P Max	P <sup>1</sup> Hex Flats Ref	PGA Ref	PGR Ref	R ±.13	S ±.25	T Dia +.10 - .05	X Max O.D. Cable
10SL	9.93	17.07	54.08	76.45	55.60	14.28	22.71	19.05	3.81/8.13	1.78/6.10	18.26	25.40	3.05	7.93
12S	11.43	17.07	54.08	76.45	57.43	14.28	22.71	19.05	3.81/8.13	1.78/6.10	20.63	27.79	3.05	7.93
12	15.88	21.84	64.11	88.90	67.16	19.05	22.71	19.05	3.81/8.13	1.78/6.10	20.63	27.79	3.05	7.93
14S	11.43	17.07	55.91	80.98	57.43	14.28	27.51	22.35	4.83/9.91	2.79/7.11	23.01	30.18	3.05	11.13
14	15.88	21.84	64.11	92.48	67.16	19.05	27.51	22.35	4.83/9.91	2.79/7.11	23.01	30.18	3.05	11.13
16S	11.43	17.07	55.91	82.93	57.56	14.28	30.00	23.88	5.84/11.94	4.83/8.89	24.61	32.54	3.05	13.49
16	15.88	21.84	64.11	94.44	67.16	19.05	30.00	23.88	5.84/11.94	4.83/8.89	24.61	32.54	3.05	13.49
18	15.88	22.63	65.94	94.44	68.99	19.05	33.02	23.88	5.84/11.94	4.83/8.89	27.00	34.93	3.05	15.88
20	15.88	22.63	67.41	96.47	70.46	19.05	37.77	26.92	9.91/14.22	6.86/11.94	29.36	38.10	3.05	19.05
22	15.88	22.63	67.41	103.63	74.07	19.05	37.77	26.92	9.91/14.22	6.86/11.94	31.75	41.28	3.05	19.05
24	15.88	24.21	73.28	105.21	77.50	20.63	43.49	26.92	9.91/14.22	6.86/11.94	34.93	44.45	3.73	23.83
28	15.88	24.21	73.28	108.99	79.76	20.63	43.49	33.02	12.95/18.03	8.89/16.00	39.68	50.80	3.73	23.83
32	15.88	26.19	74.75	117.93	80.87	22.23	52.40	41.91	17.78/24.89	12.95/20.07	44.45	57.15	4.39	31.75
36	15.88	26.19	74.75	117.93	82.42	22.23	57.99	41.91	17.78/24.89	12.95/20.07	49.23	63.50	4.39	34.93
40	15.88	26.19	77.93	143.13	93.22	22.23	68.28	41.91	17.78/24.89	12.95/20.07	55.58	69.85	4.39	41.28

All dimensions for reference only.

# AC Threaded line receptacle

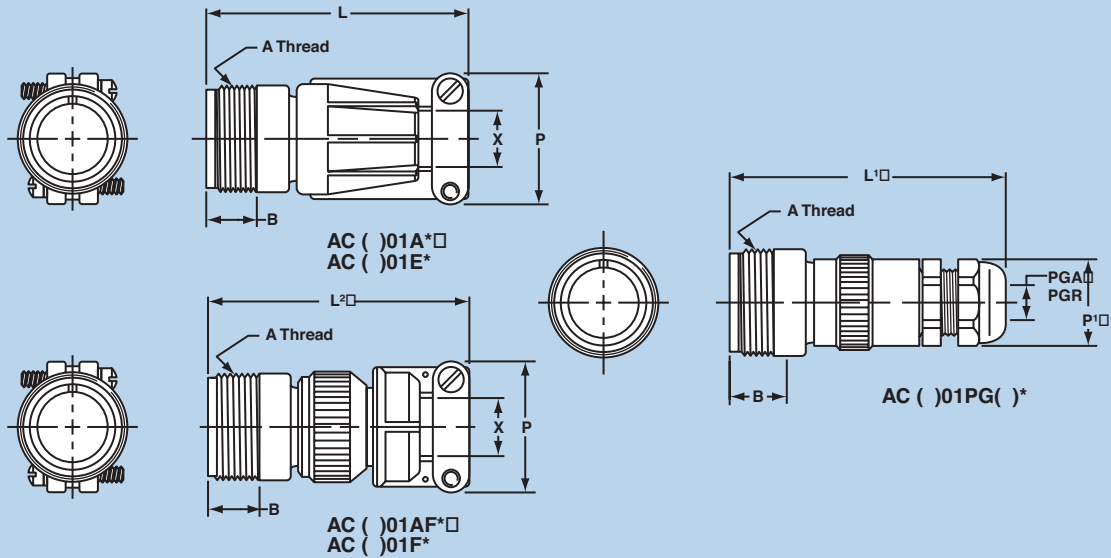

\* To complete order number, see how to order, page 59.

Inches

Shell Size	A Thread Class 2 A	B Min Full Thread	L Max	L¹ Max	L² Max	P Max	P¹ HexFlats Ref	PGA Ref	PGR Ref	X Max O.D. Cable
10SL	.6250-24UNEF	.406	2.129	3.010	2.189	.894	.750	.150/.320	.070/.240	.312
12S	.7500-20UNEF	.422	2.129	3.010	2.261	.894	.750	.150/.320	.070/.240	.312
12	.7500-20UNEF	.656	2.524	3.500	2.644	.894	.750	.150/.320	.070/.240	.312
14S	.8750-20UNEF	.391	2.201	3.188	2.261	1.083	.880	.190/.390	.110/.280	.438
14	.8750-20UNEF	.625	2.524	3.641	2.644	1.083	.880	.190/.390	.110/.280	.438
16S	1.0000-20UNEF	.391	2.201	3.265	2.266	1.181	.940	.230/.470	.190/.350	.531
16	1.0000-20UNEF	.625	2.524	3.718	2.644	1.181	.940	.230/.470	.190/.350	.531
18	1.1250-18UNEF	.625	2.596	3.718	2.716	1.300	.940	.230/.470	.190/.350	.625
20	1.2500-18UNEF	.625	2.654	3.798	2.774	1.487	1.060	.390/.560	.270/.470	.750
22	1.3750-18UNEF	.625	2.654	4.080	2.916	1.487	1.060	.390/.560	.270/.470	.750
24	1.5000-18UNEF	.625	2.885	4.142	3.051	1.712	1.060	.390/.560	.270/.470	.938
28	1.7500-18UNEF	.625	2.885	4.291	3.140	1.712	1.300	.510/.710	.350/.630	.938
32	2.0000-18UNEF	.625	2.943	4.643	3.184	2.063	1.650	.700/.980	.510/.790	1.250
36	2.2500-16UN	.625	2.943	4.643	3.245	2.283	1.650	.700/.980	.510/.790	1.375
40	2.5000-16UN	.625	3.068	5.635	3.670	2.688	1.650	.700/.980	.510/.790	1.625

Millimeters

Shell Size	B Min Full Thread	L Max	L¹ Max	L² Max	P Max	P¹ Hex Flats Ref	PGA Ref	PGR Ref	X Max O.D. Cable
10SL	10.31	54.08	76.45	55.60	22.71	19.05	3.81/8.13	1.78/6.10	7.93
12S	10.72	54.08	76.45	57.43	22.71	19.05	3.81/8.13	1.78/6.10	7.93
12	16.66	64.11	88.90	67.16	22.71	19.05	3.81/8.13	1.78/6.10	7.93
14S	9.93	55.91	80.98	57.43	27.51	22.35	4.83/9.91	2.79/7.11	11.13
14	15.88	64.11	92.48	67.16	27.51	22.35	4.83/9.91	2.79/7.11	11.13
16S	9.93	55.91	82.93	57.56	30.00	23.88	5.84/11.94	4.83/8.89	13.49
16	15.88	64.11	94.44	67.16	30.00	23.88	5.84/11.94	4.83/8.89	13.49
18	15.88	65.94	94.44	68.99	33.02	23.88	5.84/11.94	4.83/8.89	15.88
20	15.88	67.41	96.47	70.46	37.77	26.92	9.91/14.22	6.86/11.94	19.05
22	15.88	67.41	103.63	74.07	37.77	26.92	9.91/14.22	6.86/11.94	19.05
24	15.88	73.28	105.21	77.50	43.49	26.92	9.91/14.22	6.86/11.94	23.83
28	15.88	73.28	108.99	79.76	43.49	33.02	12.95/18.03	8.89/16.00	23.83
32	15.88	74.75	117.93	80.87	52.40	41.91	17.78/24.89	12.95/20.07	31.75
36	15.88	74.75	117.93	82.42	57.99	41.91	17.78/24.89	12.95/20.07	34.93
40	15.88	77.93	143.13	93.22	68.28	41.91	17.78/24.89	12.95/20.07	41.28

All dimensions for reference only.

# AC Threaded box mounting receptacle

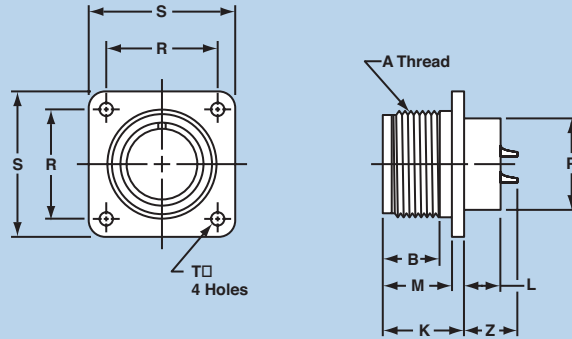

AC ( )02A\*□  
AC ( )02E\*

\* To complete order number, see how to order, page 59.

Inches

Shell Size	A Thread Class 2 A	B Min Full Thread	K +.020 -0.010	L +.000 -0.010	M +.010 -0.000	P Dia +.010 -0.000	R ±.005	S ±.031	T Dia +.004 -0.002	Z Max**
8S	.5000-28UNEF	.391	.672	.297	.562	.375	.594	.875	.120	.519
10S	.6250-24NEF	.391	.672	.297	.562	.500	.719	1.000	.120	.519
10SL	.6250-24NEF	.391	.672	.297	.562	.625	.719	1.000	.120	.519
12S	.7500-20UNEF	.450	.672	.297	.562	.625	.812	1.094	.120	.519
12	.7500-20UNEF	.625	.860	.484	.750	.625	.812	1.094	.120	.722
14S	.8750-20UNEF	.450	.672	.297	.562	.750	.906	1.188	.120	.519
14	.8750-20UNEF	.625	.860	.484	.750	.750	.906	1.188	.120	.722
16S	1.0000-20UNEF	.450	.672	.297	.562	.875	.969	1.281	.120	.519
16	1.0000-20UNEF	.625	.860	.484	.750	.875	.969	1.281	.120	.722
18	1.1250-18NEF	.625	.891	.453	.750	1.000	1.062	1.375	.120	.691
20	1.2500-18NEF	.625	.891	.453	.750	1.125	1.156	1.500	.120	.691
22	1.3750-18NEF	.625	.891	.453	.750	1.250	1.250	1.625	.120	.691
24	1.5000-18NEF	.625	.953	.453	.812	1.375	1.375	1.750	.147	.628
28	1.7500-18NS	.625	.953	.453	.812	1.625	1.562	2.000	.147	.628
32	2.0000-18NS	.625	1.031	.438	.875	1.875	1.750	2.250	.173	.550
36	2.2500-16UN	.625	1.031	.438	.875	2.062	1.938	2.500	.173	.550
40	2.5000-16UN	.625	1.031	.438	.875	2.312	2.188	2.750	.173	.550

Millimeters

Shell Size	B Min Full Thread	K +.51 -0.25	L +.00 -0.25	M +.25 -0.00	P Dia +.25 -0.00	R ±.13	S ±.79	T Dia +.10 -0.05	Z Max**
8S	9.93	17.07	7.54	14.28	9.53	15.09	22.23	3.05	13.18
10S	9.93	17.07	7.54	14.28	12.70	18.26	25.40	3.05	13.18
10SL	9.93	17.07	7.54	14.28	15.88	18.26	25.40	3.05	13.18
12S	11.43	17.07	7.54	14.28	15.88	20.63	27.79	3.05	13.18
12	15.88	21.84	12.29	19.05	15.88	20.63	27.79	3.05	18.34
14S	11.43	17.07	7.54	14.28	19.05	23.01	30.18	3.05	13.18
14	15.88	21.84	12.29	19.05	19.05	23.01	30.18	3.05	18.34
16S	11.43	17.07	7.54	14.28	22.23	24.61	32.54	3.05	13.18
16	15.88	21.84	12.29	19.05	22.23	24.61	32.54	3.05	18.34
18	15.88	22.63	11.51	19.05	25.40	26.98	34.93	3.05	17.55
20	15.88	22.63	11.51	19.05	28.58	29.36	38.10	3.05	17.55
22	15.88	22.63	11.51	19.05	31.75	31.75	41.28	3.05	17.55
24	15.88	24.21	11.51	20.63	34.93	34.93	44.45	3.73	15.95
28	15.88	24.21	11.51	20.63	41.28	39.68	50.80	3.73	15.95
32	15.88	26.19	11.13	22.23	47.63	44.45	57.15	4.39	13.97
36	15.88	26.19	11.13	22.23	52.38	49.23	63.50	4.39	13.97
40	15.88	26.19	11.13	22.23	58.73	55.58	69.85	4.39	13.97

\*\* Increase Z dimension by .312 for size "0" contact only.

All dimensions for reference only.



# AC Threaded straight plug

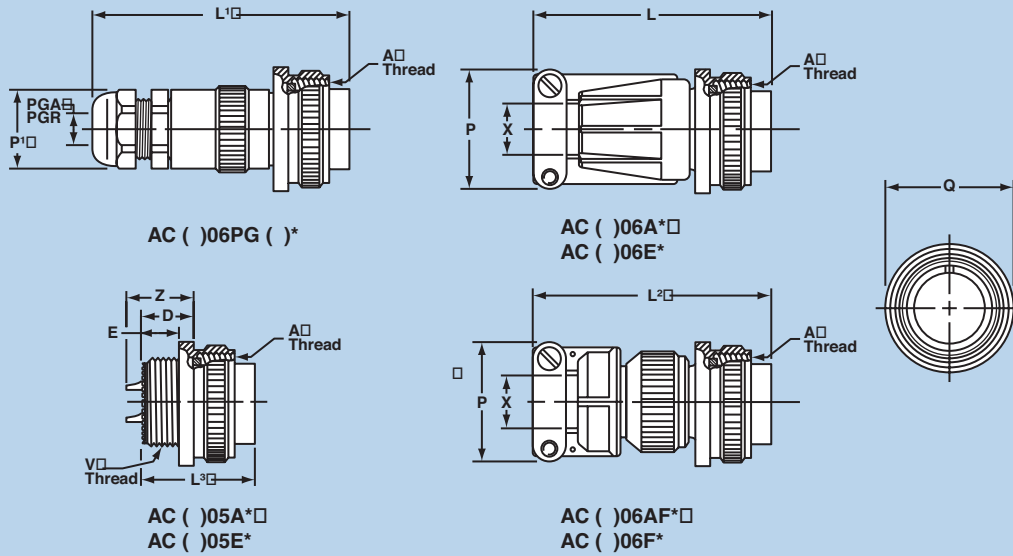

\* To complete order number, see how to order, page 59.

Inches

Shell Size	A Thread Class 2B	D ±.010	E +.020 -0.030	L Max	L' Max	L² Max	L³ Max	P Max	P¹ Hex Flats Ref	PGA Ref	PGR Ref	Q Max	V Thread Plated Class 2A	X Max O.D. Cable	Z ±.045
10SL	.6250-24UNEF	.438	.298	2.129	3.010	2.189	.989	.894	.750	.150/.320	.070/.240	.946	.6250-24UNEF	.312	.562
12S	.7500-20UNEF	.438	.312	2.129	3.010	2.261	.989	.894	.750	.150/.320	.070/.240	.995	.6250-24UNEF	.312	.562
12	.7500-20UNEF	.625	.469	2.524	3.500	2.644	1.364	.894	.750	.150/.320	.070/.240	.995	.6250-24UNEF	.312	.812
14S	.8750-20UNEF	.438	.312	2.201	3.188	2.261	.989	1.083	.880	.190/.390	.110/.280	1.123	.7500-20UNEF	.438	.562
14	.8750-20UNEF	.625	.469	2.524	3.641	2.644	1.364	1.083	.880	.190/.390	.110/.280	1.123	.7500-20UNEF	.438	.812
16S	1.0000-20UNEF	.438	.312	2.201	3.265	2.266	.989	1.181	.940	.230/.470	.190/.350	1.250	.8750-20UNEF	.531	.562
16	1.0000-20UNEF	.625	.469	2.524	3.718	2.644	1.364	1.181	.940	.230/.470	.190/.350	1.250	.8750-20UNEF	.531	.812
18	1.1250-18UNEF	.625	.469	2.596	3.718	2.716	1.364	1.300	.940	.230/.470	.190/.350	1.333	1.0000-20UNEF	.625	.812
20	1.2500-18UNEF	.625	.469	2.654	3.798	2.774	1.364	1.487	1.060	.390/.560	.270/.470	1.461	1.1250-18UNEF	.750	.812
22	1.3750-18UNEF	.625	.469	2.654	4.080	2.916	1.364	1.487	1.060	.390/.560	.270/.470	1.588	1.2500-18UNEF	.750	.812
24	1.5000-18UNEF	.688	.469	2.885	4.142	3.051	1.427	1.712	1.060	.390/.560	.270/.470	1.715	1.3750-18UNEF	.938	.812
28	1.7500-18UNS	.688	.469	2.885	4.291	3.140	1.427	1.712	1.300	.510/.710	.350/.630	1.968	1.6250-18UNEF	.938	.812
32	2.0000-18UNS	.750	.469	2.943	4.643	3.184	1.489	2.063	1.650	.700/.980	.510/.790	2.209	1.8750-16UN	1.250	.812
36	2.2500-16UN	.750	.469	2.943	4.643	3.245	1.489	2.283	1.650	.700/.980	.510/.790	2.463	2.0625-16UN	1.375	.812
40	2.5000-16UN	.750	.469	3.068	5.635	3.670	1.489	2.688	1.650	.700/.980	.510/.790	2.718	2.3125-16UN	1.625	.812

Millimeters

Shell Size	D ±.25	E +.51 -0.76	L Max	L' Max	L² Max	L³ Max	P Max	P¹ Hex Flats Ref	PGA Ref	PGR Ref	Q Max	X Max O.D. Cable	Z ±1.14
10SL	11.13	7.57	54.08	76.45	55.60	25.12	22.71	19.05	3.81/8.13	1.78/6.10	24.03	7.93	14.28
12S	11.13	7.93	54.08	76.45	57.43	25.12	22.71	19.05	3.81/8.13	1.78/6.10	25.27	7.93	14.28
12	15.88	11.91	64.11	88.90	67.16	34.65	22.71	19.05	3.81/8.13	1.78/6.10	25.27	7.93	20.63
14S	11.13	7.93	55.91	80.98	57.43	25.12	27.51	22.35	4.83/9.91	2.79/7.11	28.52	11.13	14.28
14	15.88	11.91	64.11	92.48	67.16	34.65	27.51	22.35	4.83/9.91	2.79/7.11	28.52	11.13	20.63
16S	11.13	7.93	55.91	82.93	57.56	25.12	30.00	23.88	5.84/11.94	4.83/8.89	31.75	13.49	14.28
16	15.88	11.91	64.11	94.44	67.16	34.65	30.00	23.88	5.84/11.94	4.83/8.89	31.75	13.49	20.63
18	15.88	11.91	65.94	94.44	68.99	34.65	33.02	23.88	5.84/11.94	4.83/8.89	33.86	15.88	20.63
20	15.88	11.91	67.41	96.47	70.46	34.65	37.77	26.92	9.91/14.22	6.86/11.94	37.11	19.05	20.63
22	15.88	11.91	67.41	103.63	74.07	34.65	37.77	26.92	9.91/14.22	6.86/11.94	40.34	19.05	20.63
24	17.48	11.91	73.28	105.21	77.50	36.25	43.49	26.92	9.91/14.22	6.86/11.94	43.56	23.83	20.63
28	17.48	11.91	73.28	108.99	79.76	36.25	43.49	33.02	12.95/18.03	8.89/16.00	49.99	23.83	20.63
32	19.05	11.91	74.75	117.93	80.87	37.82	52.40	41.91	17.78/24.89	12.95/20.07	56.11	31.75	20.63
36	19.05	11.91	74.75	117.93	82.42	37.82	57.99	41.91	17.78/24.89	12.95/20.07	62.56	34.93	20.63
40	19.05	11.91	77.93	143.13	93.22	37.82	68.28	41.91	17.78/24.89	12.95/20.07	69.04	41.28	20.63

All dimensions for reference only.

# AC Threaded 90 degree plug

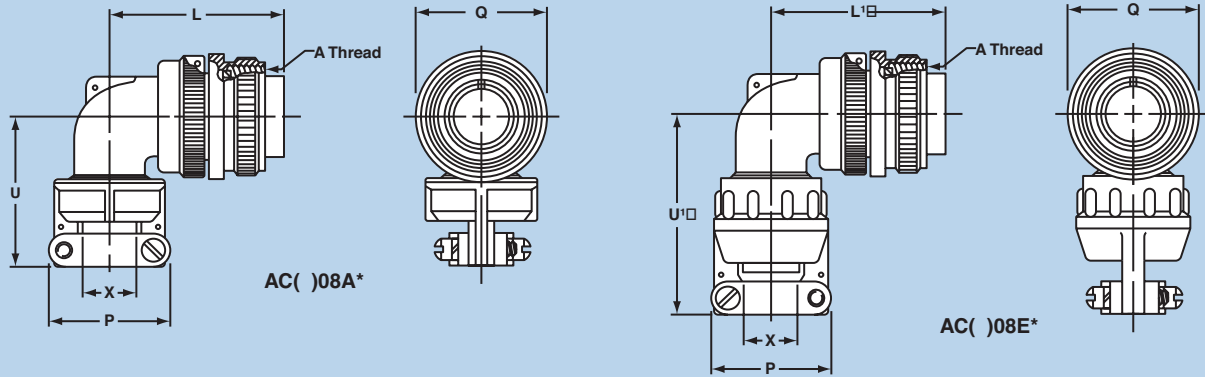

\* To complete order number, see how to order, page 59.

Inches

Shell Size	A Thread Class 2B	L Max	L' Max	P Max	Q Dia Max	U Max	U' Max	X Max O.D. Cable
10SL	.6250-24NEF	1.492	1.492	.906	.946	1.305	1.812	.312
12S	.7500-20UNEF	1.492	1.492	.906	.995	1.305	1.812	.312
12	.7500-20UNEF	1.867	1.867	.906	.995	1.305	1.812	.312
14S	.8750-20UNEF	1.556	1.556	1.031	1.123	1.485	1.875	.438
14	.8750-20UNEF	1.931	1.931	1.031	1.123	1.485	1.875	.438
16S	1.0000-20UNEF	1.682	1.682	1.125	1.250	1.612	1.937	.531
16	1.0000-20UNEF	2.057	2.057	1.125	1.250	1.612	1.937	.531
18	1.1250-18NEF	2.119	2.119	1.234	1.333	1.738	2.109	.625
20	1.2500-18NEF	2.369	2.322	1.484	1.461	1.800	2.187	.750
22	1.3750-18NEF	2.369	2.322	1.484	1.588	1.862	2.250	.750
24	1.5000-18NEF	2.620	2.510	1.683	1.715	2.100	2.484	.938
28	1.7500-18NS	2.620	2.510	1.683	1.968	2.162	2.546	.938
32	2.0000-18NS	2.842	2.744	2.188	2.209	2.405	3.045	1.250
36	2.2500-16UN	2.900	2.869	2.344	2.463	2.536	3.218	1.375
40	2.5000-16UN	3.025	2.994	2.688	2.719	3.206	3.375	1.625

Millimeters

Shell Size	L Max	L' Max	P Max	Q Dia Max	U Max	U' Max	X Max O.D. Cable
10SL	37.90	37.90	23.01	24.03	33.15	46.03	7.93
12S	37.90	37.90	23.01	25.27	33.15	46.03	7.93
12	47.42	47.42	23.01	25.27	33.15	46.03	7.93
14S	39.52	39.52	26.19	28.52	37.72	47.63	11.13
14	49.05	49.05	26.19	28.52	37.72	47.63	11.13
16S	42.72	42.72	28.58	31.75	40.95	49.20	13.49
16	52.25	52.25	28.58	31.75	40.95	49.20	13.49
18	53.82	53.82	31.34	33.86	44.15	53.57	15.88
20	60.17	58.98	37.69	37.11	45.72	55.55	19.05
22	60.17	58.98	37.69	40.34	47.30	57.15	19.05
24	66.55	63.75	42.75	43.56	53.34	63.09	23.83
28	66.55	63.75	42.75	49.99	54.92	64.67	23.83
32	72.19	69.70	55.58	56.11	61.09	77.34	31.75
36	73.66	72.87	59.54	62.56	64.41	81.74	34.93
40	76.84	76.05	68.28	69.06	81.43	85.73	41.28

All dimensions for reference only.



# Amphenol SAE AS50151 Standard Cylindrical Connectors

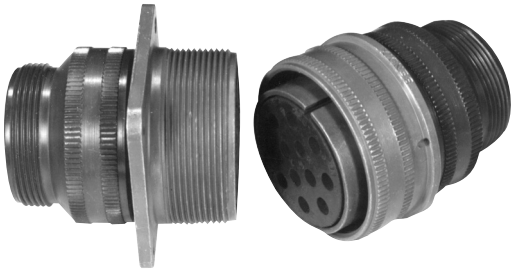

**MS-A, MS-C**



**MS-E/F**



**MS-R**

## DESIGN CHARACTERISTICS

- Medium to heavy weight cylindrical
- Durable, field-proven design
- Environmental resistant
- Resilient inserts
- Operating voltage to 3000 VAC (RMS) at sea level
- Threaded couplings
- Single key/keyway shell polarization

## CUSTOMER OPTIONS

- Five shell styles
- Nineteen shell sizes
- 305 contact arrangements from 1 to 104 circuits
- Solder or crimp contacts, sizes 16-0 accepting 22-0 AWG.
- Five class designations
- Alternate insert positioning
- Hermetic configurations available

MS connectors meet the latest performance requirements of SAE AS50151. These connectors represent well-proven electrical capability at an acceptable cost for most equipment where durability is important.

SAE AS50151 features threaded couplings and single key/keyway polarization, representing maximum simplicity in design. Applications include military ground support equipment, ordnance and shipboard installations.

Amphenol Industrial Operations manufactures five classes of connectors to meet different requirements. Class designations and brief descriptions are listed below.

A – Solid Shell – for general, non-environmental applications.

C – Pressurized – for use on pressurized bulkheads or pressure barriers; limits air leakage regardless of type and class of plug mated with them.

E/F –Environmental Resisting with Strain Relief – designed for applications where the connector will be exposed to moisture, vibration, and rapid changes in pressure and temperature.

R – Lightweight Environmental Resisting – shorter in length and lighter in weight than the E and F classes, the MS-R offers a high degree of reliability under adverse conditions: recommended for new design applications.

Environmental Classes F and R are updated to and produced in strict accordance to SAE AS50151. Classes A, C and E are still produced, but are no longer listed on the qualified products database (QPD).

# MS/Standard MS-A and MS-C

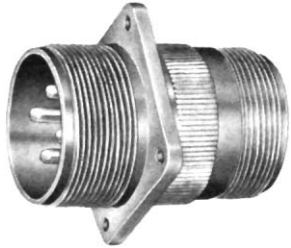

wall mounting receptacle

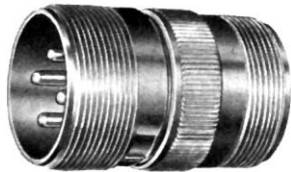

inline receptacle

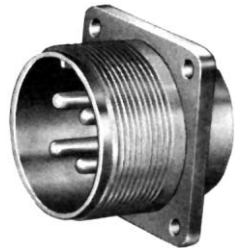

box mounting receptacle



straight plug

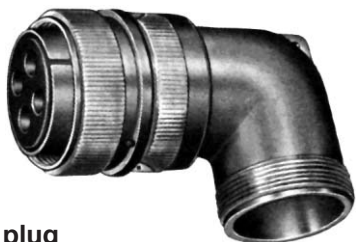

90 degree plug

## MS-A and MS-C

MS-A and MS-C class connectors perform many of the vital functions in powering, testing and ground support systems. Class A applications include communications equipment, computers and shipboard installations where mechanical forces and physical parameters are not subject to extreme or rapid environmental changes.

Class C connectors are most frequently used on pressurized bulkheads or pressure barriers at elevated altitudes or maritime applications. Air leakage is limited to one cubic inch per hour at a pressure differential of 30 lbs. per square inch.

### Shells:

Shell components are fabricated from high grade aluminum alloy. Electrically conductive cadmium plate finish with an olive drab chromate after-treat offers corrosion resistance.

### Contacts:

Contacts are solder with pre-filled solder cups. Pins and sockets are machined from copper alloy with a silver plated finish. Size 16 and 12 socket contacts incorporate a closed entry design. Refer to page 54 for additional contact information.

### Inserts:

Inserts are resilient neoprene, offering high dielectric strength, high arc resistance and resistance to vibration.

# MS/Standard MS3100A or C wall mounting receptacle

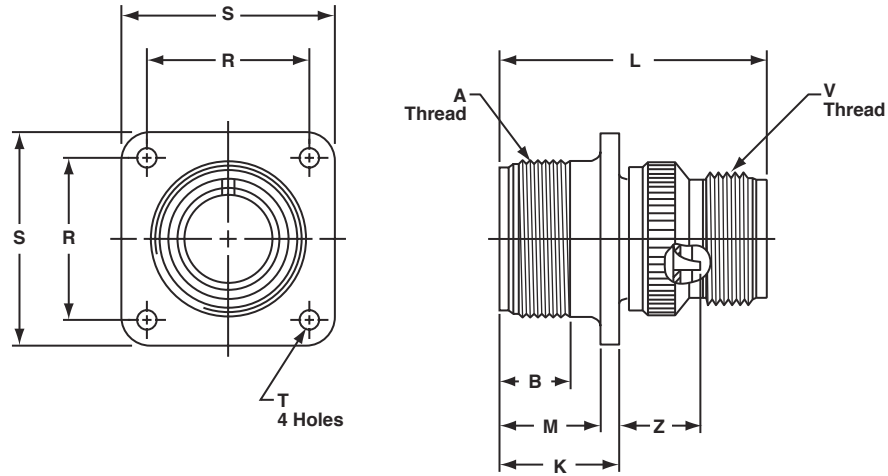

To complete order number, see "how to order" pg. 59.  
For solder well data, see page 29.

Shell Size	A Thread Class 2A	B Min Full Thread	K $+0.020$ $-0.010$	L $\pm 0.030$	M $+0.010$ $-0.000$	R $\pm 0.005$	S $\pm 0.031$	T Dia. $+0.004$ $-0.002$	V Thread Class 2A	Z $+0.050$ $-0.060$
8S	.5000-28UNEF	.391	.672	1.391	.562	.594	.875	.120	.5000-28UNEF	.422
10S	.6250-24 UNF	.391	.672	1.468	.562	.719	1.000	.120	.5000-28UNEF	.422
10SL	.6250-24 UNF	.391	.672	1.468	.562	.719	1.000	.120	.6250-24NEF	.422
12S	.7500-20UNEF	.450	.672	1.468	.562	.812	1.094	.120	.6250-24NEF	.422
12	.7500-20UNEF	.625	.860	1.843	.750	.812	1.094	.120	.6250-24NEF	.672
14S	.8750-20UNEF	.450	.672	1.468	.562	.906	1.188	.120	.7500-20UNEF	.422
14	.8750-20UNEF	.625	.860	1.843	.750	.906	1.188	.120	.7500-20UNEF	.672
16S	1.0000-20UNEF	.450	.672	1.468	.562	.969	1.281	.120	.8750-20UNEF	.422
16	1.0000-20UNEF	.625	.860	1.843	.750	.969	1.281	.120	.8750-20UNEF	.672
18	1.1250-18NEF	.625	.891	1.938	.750	1.063	1.375	.120	1.0000-20UNEF	.641*
20	1.2500-18NEF	.625	.891	1.844	.750	1.156	1.500	.120	1.1875-18NEF	.641*
22	1.3750-18NEF	.625	.891	1.938	.750	1.250	1.625	.120	1.1875-18NEF	.641*
24	1.5000-18NEF	.625	.953	1.969	.812	1.375	1.750	.147	1.4375-18NEF	.578*
28	1.7500-18NS	.625	.953	2.188	.812	1.562	2.000	.147	1.4375-18NEF	.578*
32	2.0000-18NS	.625	1.031	2.157	.875	1.750	2.250	.173	1.7500-18NS	.500*
36	2.2500-16UN	.625	1.031	2.219	.875	1.938	2.500	.173	2.0000-18NS	.500*
40	2.5000-16UN	.625	1.031	2.188	.875	2.188	2.750	.173	2.2500-16UN	.500*
44***	2.7500-16UN	.625	1.031†	2.547	.875	2.375	3.000††	.173	2.5000-16UN	.751**
48***	3.0000-16UN	.625	1.031†	2.547	.875	2.625	3.000††	.173	3.0000-16UN	.751**

\* Increase Z dimension by .312 for size "0" contact only.

\*\* Increase Z dimension by .062 for size "0" contact only.

\*\*\* Available in proprietary version only.

†  $+0.020$   $-0.030$

††  $\pm 0.020$

# MS/Standard MS3101A inline receptacle

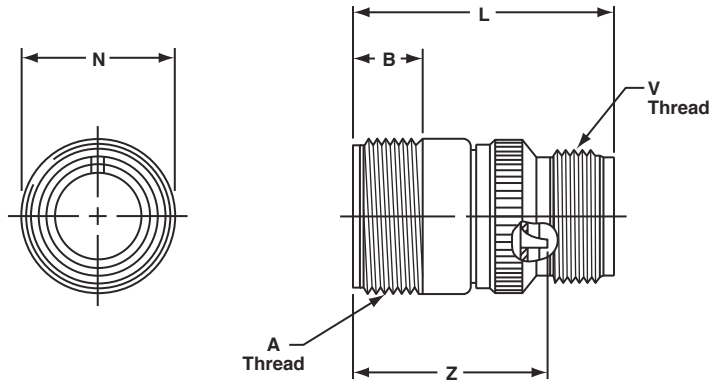

To complete order number, see "how to order" pg. 59.  
For solder well data, see page 29.

Shell Size	A Thread Class 2A	B Min. Full Thread	L $\pm.030$	N Dia. Max.	V Thread Class 2A	Z $\pm.040$
8S	.5000-28UNEF	.406	1.390	.532	.5000-28UNEF	1.094
10S	.6250-24NEF	.406	1.468	.628	.5000-28UNEF	1.094
10SL	.6250-24NEF	.406	1.468	.755	.6250-24NEF	1.094
12S	.7500-20UNEF	.422	1.468	.755	.6250-24NEF	1.094
12	.7500-20UNEF	.656	1.843	.755	.6250-24NEF	1.532
14S	.8750-20UNEF	.391	1.468	.882	.7500-20UNEF	1.094
14	.8750-20UNEF	.625	1.843	.882	.7500-20UNEF	1.532
16S	1.0000-20UNEF	.391	1.468	1.010	.8750-20UNEF	1.094
16	1.0000-20UNEF	.625	1.843	1.010	.8750-20UNEF	1.532
18	1.1250-18NEF	.625	1.938	1.137	1.0000-20UNEF	1.532*
20	1.2500-18NEF	.625	1.844	1.264	1.1875-18NEF	1.532*
22	1.3750-18NEF	.625	1.938	1.392	1.1875-18NEF	1.532*
24	1.5000-18NEF	.625	1.969	1.519	1.4375-18NEF	1.532*
28	1.7500-18NS	.625	2.188	1.774	1.4375-18NEF	1.532*
32	2.0000-18NS	.625	2.157	1.996	1.7500-18NS	1.532*
36	2.2500-16UN	.625	2.219	2.251	2.0000-18NS	1.532*
40	2.5000-16UN	.625	2.188	2.506	2.2500-16UN	1.532*
44***	2.7500-16UN	.625	2.521	3.135	2.5000-16UN	1.782**

\* Increase Z dimension by .312 for size "0" contact only.  
\*\* Increase Z dimension by .062 for size "0" contact only.  
\*\*\* Available in proprietary version only.

# MS/Standard MS3102A or C box mounting receptacle

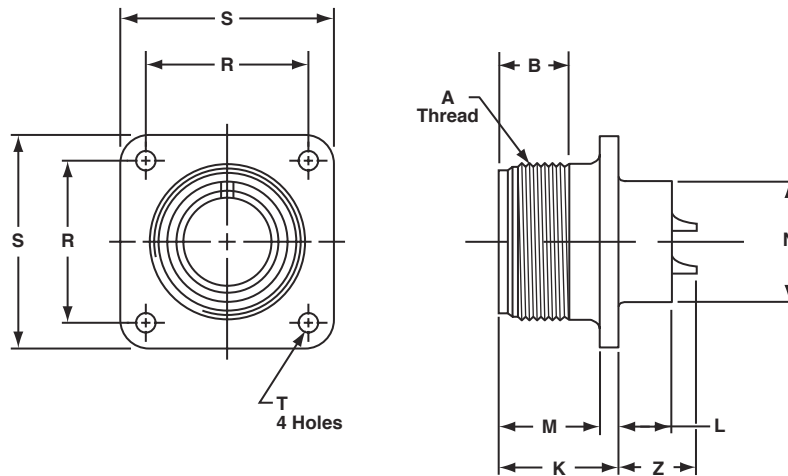

To complete order number, see "how to order" pg. 59.  
For solder well data, see page 29.

Shell Size	A Thread Class 2A	B Min Full Thread	K +.020 -0.010	L +.000 -0.010	M +.010 -0.000	N Dia. +.010 -0.000	R ±.005	S ±.031	T Dia. +.004 -0.002	Z +.050 -0.060
8S	.5000-28UNEF	.391	.672	.297	.562	.375	.594	.875	.120	.422
10S	.6250-24NEF	.391	.672	.297	.562	.500	.719	1.000	.120	.422
10SL	.6250-24NEF	.391	.672	.297	.562	.625	.719	1.000	.120	.422
12S	.7500-20UNEF	.450	.672	.297	.562	.625	.812	1.094	.120	.422
12	.7500-20UNEF	.625	.860	.484	.750	.625	.812	1.094	.120	.672
14S	.8750-20UNEF	.450	.672	.297	.562	.750	.906	1.188	.120	.422
14	.8750-20UNEF	.625	.860	.484	.750	.750	.906	1.188	.120	.672
16S	1.0000-20UNEF	.450	.672	.297	.562	.875	.969	1.281	.120	.422
16	1.0000-20UNEF	.625	.860	.484	.750	.875	.969	1.281	.120	.672
18	1.1250-18NEF	.625	.891	.453	.750	1.000	1.062	1.375	.120	.641*
20	1.2500-18NEF	.625	.891	.453	.750	1.125	1.156	1.500	.120	.641*
22	1.3750-18NEF	.625	.891	.453	.750	1.250	1.250	1.625	.120	.641*
24	1.5000-18NEF	.625	.953	.453	.812	1.375	1.375	1.750	.147	.578
28	1.7500-18NS	.625	.953	.453	.812	1.625	1.562	2.000	.147	.578*
32	2.0000-18NS	.625	1.031	.438	.875	1.875	1.750	2.250	.173	.500*
36	2.2500-16UN	.625	1.031	.438	.875	2.062	1.938	2.500	.173	.500*
40	2.5000-16UN	.625	1.031	.438	.875	2.312	2.188	2.750	.173	.500*
44***	2.7500-16UN	.625	1.063	.543†	.875	2.594	2.375	3.000††	.173	.768**
48***	3.0000-16UN	.625	1.063	.543†	.875	2.812	2.625	3.250††	.209	.769**

\* Increase Z dimension by .312 for size "0" contact only.  
\*\* Increase Z dimension by .062 for size "0" contact only.  
\*\*\* Available in proprietary version only.  
† +.020 -0.030  
†† ±.020

# MS/Standard MS3106A straight plug

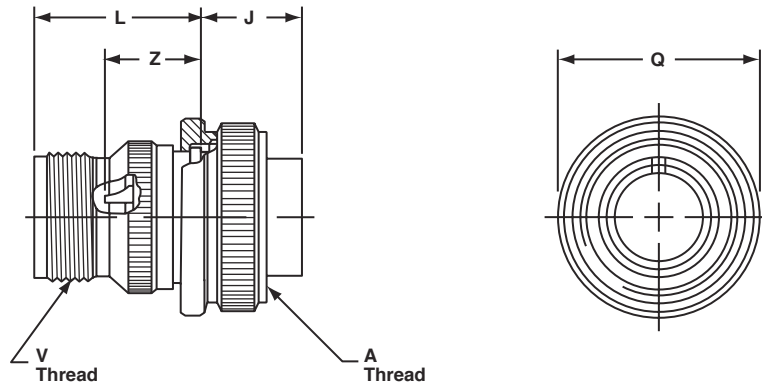

To complete order number, see "how to order" pg. 59.  
For solder well data, see page 29.  
All lockwire holes are .045 dia. min.

Shell Size	A Thread Class 2B	J $\pm.005$	L $\pm.030$	Q Dia. Max.	V Thread Class 2A	Z $\pm.045$
8S	.5000-28UNEF	.531	.859	.741	.5000-28UNEF	.562
10S	.6250-24NEF	.531	.937	.869	.5000-28UNEF	.562
10SL	.6250-24NEF	.531	.937	.946	.6250-24NEF	.562
12S	.7500-20UNEF	.531	.937	.995	.6250-24NEF	.562
12	.7500-20UNEF	.719	1.124	.995	.6250-24NEF	.812
14S	.8750-20UNEF	.531	.937	1.123	.7500-20UNEF	.562
14	.8750-20UNEF	.719	1.124	1.123	.7500-20UNEF	.812
16S	1.0000-20UNEF	.531	.937	1.250	.8750-20UNEF	.562
16	1.0000-20UNEF	.719	1.124	1.250	.8750-20UNEF	.812
18	1.1250-18NEF	.719	1.219	1.333	1.0000-20UNEF	.812*
20	1.2500-18NEF	.719	1.125	1.461	1.1875-18NEF	.812*
22	1.3750-18NEF	.719	1.219	1.588	1.1875-18NEF	.812*
24	1.5000-18NEF	.719	1.251	1.715	1.4375-18NEF	.812*
28	1.7500-18NS	.719	1.470	1.968	1.4375-18NEF	.812*
32	2.0000-18NS	.719	1.439	2.209	1.7500-18NS	.812*
36	2.2500-16UN	.719	1.500	2.463	2.0000-18NS	.812*
40	2.5000-16UN	.719	1.469	2.719	2.2500-16UN	.812*
44***	2.7500-16UN	.719	1.818†	3.084	2.5000-16UN	1.063**
48***	3.3000-16UN	.719	1.818†	3.354	3.0000-16UN	1.063**

\* Increase Z dimension by .312 for size "0" contact only.  
\*\* Increase Z dimension by .062 for size "0" contact only.  
\*\*\* Available in proprietary version only.  
† +.020 -.030



# MS/Standard MS3108A 90 degree plug

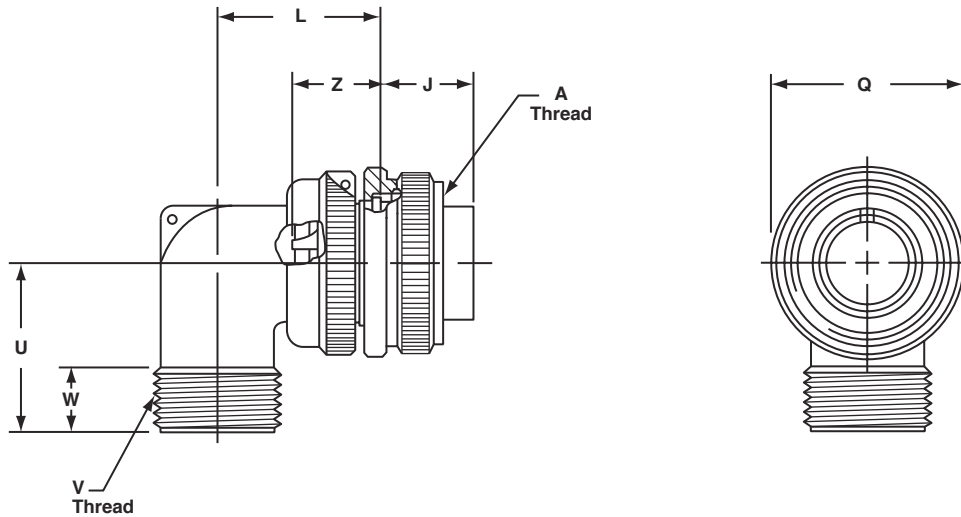

To complete order number, see "how to order" pg. 59.  
For solder well data, see page 29.  
All lockwire holes are .045 dia. min.

Shell Size	A Thread Class 2B	J $\pm.005$	L Max.	Q Dia. Max.	U Max.	V Thread Class 2A	W	Z $\pm.045$
8S	.5000-28UNEF	.531	.896	.741	.750	.5000-28UNEF	.375	.562
10S	.6250-24NEF	.531	.927	.869	.750	.5000-28UNEF	.375	.562
10SL	.6250-24NEF	.531	.951	.946	.875	.6250-24NEF	.375	.562
12S	.7500-20UNEF	.531	.956	.995	.875	.6250-24NEF	.375	.562
12	.7500-20UNEF	.719	1.143	.995	.875	.6250-24NEF	.375	.812
14S	.8750-20UNEF	.531	1.120	1.123	1.000	.7500-20UNEF	.375	.562
14	.8750-20UNEF	.719	1.207	1.123	1.000	.7500-20UNEF	.375	.812
16S	1.0000-20UNEF	.531	1.146	1.250	1.062	.8750-20UNEF	.375	.562
16	1.0000-20UNEF	.719	1.332	1.250	1.062	.8750-20UNEF	.375	.812
18	1.1250-18NEF	.719	1.395	1.333	1.188	1.0000-20UNEF	.375	.812*
20	1.2500-18NEF	.719	1.645	1.461	1.250	1.1875-18NEF	.375	.812*
22	1.3750-18NEF	.719	1.645	1.588	1.312	1.1875-18NEF	.375	.812*
24	1.5000-18NEF	.719	1.896	1.715	1.438	1.4375-18NEF	.375	.812*
28	1.7500-18NS	.719	1.896	1.968	1.500	1.4375-18NEF	.375	.812*
32	2.0000-18NS	.719	2.118	2.209	1.750	1.7500-18NS	.438	.812*
36	2.2500-16UN	.719	2.176	2.463	1.875	2.0000-18NS	.500	.812*
40	2.5000-16UN	.719	2.301	2.719	2.031	2.2500-16UN	.500	.812*

\* Increase Z dimension by .312 for size "0" contact only.

# MS/Standard MS-E/F



wall mounting receptacle



inline receptacle



box mounting receptacle



straight plug



90 degree plug

## MS-E & F

MS Class F connectors satisfy all the performance requirements of SAE AS50151. Class E, environmental is also produced, but is no longer listed on the qualified products listing (QPL). These connectors are recommended for conditions where vibration, moisture, pressure and/or temperature are extreme. Strain relief is supplied on most shell sizes.

### Shells:

Shell components are fabricated from high grade aluminum alloy. The standard hardware plating is electrically conductive cadmium plated finish with an olive drab chromate after-treatment for corrosion resistance.

### Contacts:

Contacts are silver plated copper alloy for maximum corrosion resistance, maximum current carrying capacity and low millivolt drop. Size 16 and 12 socket contacts incorporate a closed entry design. Refer to page 54 for additional contact information.

### Inserts:

Resilient neoprene inserts provide an outstanding moisture barrier, high dielectric strength, and resistance to vibration. Either pin or socket insert can be pressurized.

### Strain Relief Clamp:

Strain relief clamps minimize tension at the solder well connection and provide a positive mechanical moisture seal. Complete field serviceability is possible with the strain relief clamp.

# MS/Standard MS3100E/F wall mounting receptacle

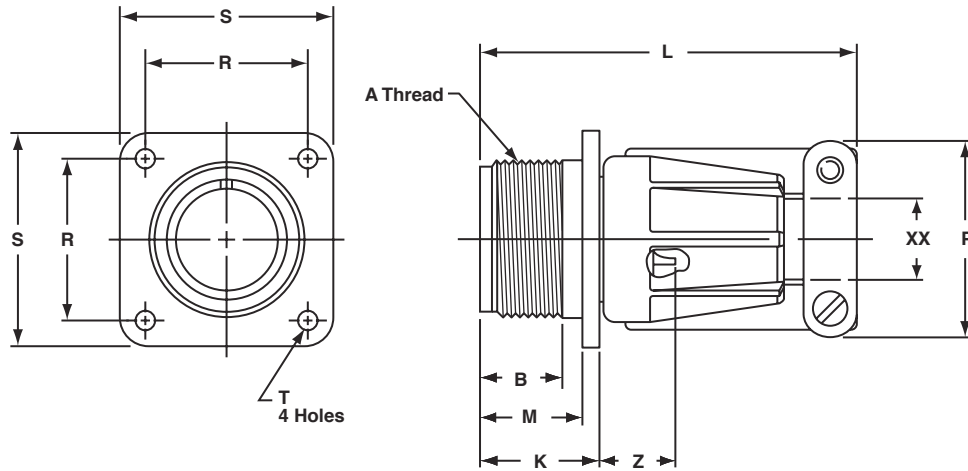

To complete order number, see "how to order" pg. 59.  
For solder well data, see page 29.

Shell Size	A Thread Class 2A	B Min. Full Thread	K +.020 - .010	L Max.	M +.010 - .000	P Max.	R ±.005	S ±.010	T Dia. +.004 - .002	Z* Max.	XX Min. Cable Clearance
10SL	.6250-24UNEF	.391	.672	2.129	.562	.896	.719	1.000	.120	.472	.281
12S	.7500-20UNEF	.450	.672	2.129	.562	.896	.812	1.094	.120	.472	.281
12	.7500-20UNEF	.625	.860	2.129	.750	.896	.812	1.094	.120	.722	.281
14S	.8750-20UNEF	.450	.672	2.201	.562	1.021	.906	1.188	.120	.472	.406
14	.8750-20UNEF	.625	.860	2.524	.750	1.021	.906	1.188	.120	.722	.406
16S	1.0000-20UNEF	.450	.672	2.201	.562	1.151	.969	1.281	.120	.472	.500
16	1.0000-20UNEF	.625	.860	2.524	.750	1.151	.969	1.281	.120	.722	.500
18	1.1250-18UNEF	.625	.891	2.596	.750	1.242	1.063	1.375	.120	.691	.531
20	1.2500-18UNEF	.625	.891	2.654	.750	1.499	1.156	1.500	.120	.691	.656
22	1.3750-18UNEF	.625	.891	2.654	.750	1.499	1.250	1.625	.120	.691	.740
24	1.5000-18UNEF	.625	.953	2.885	.812	1.781	1.375	1.750	.147	.628	.781
28	1.7500-18UNS	.625	.953	2.885	.812	1.781	1.562	2.000	.147	.628	.922
32	2.0000-18UNS	.625	1.031	2.943	.875	2.087	1.750	2.250	.173	.550	1.156
36	2.2500-16UN	.625	1.031	2.943	.875	2.281	1.938	2.500	.173	.550	1.250
40	2.5000-16UN	.625	1.031	3.068	.875	2.581	2.188	2.750	.173	.550	1.562

\* Increase Z dimension by .312 for size "0" contact only.

# MS/Standard MS3101E/F inline receptacle

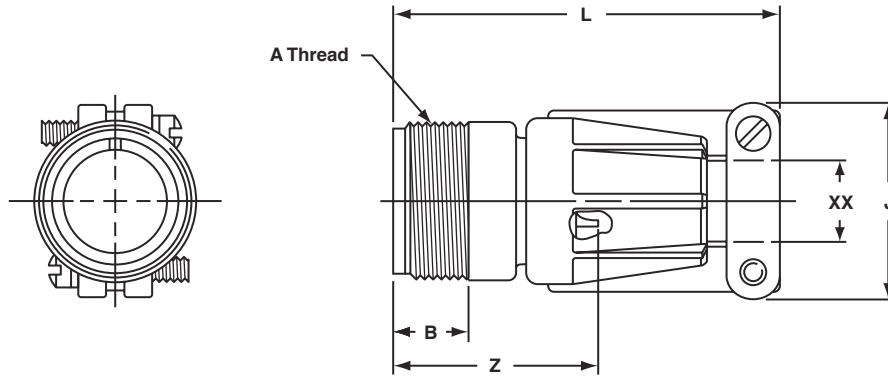

To complete order number, see "how to order" pg. 59.  
For solder well data, see page 29.

Shell Size	A Thread Class 2A	B Min. Full Thread	J Max.	L Max.	Z* Max.	XX Min. Cable Clearance
10SL	.6250-24UNEF	.406	.896	2.129	1.134	.281
12S	.7500-20UNEF	.422	.896	2.129	1.134	.281
12	.7500-20UNEF	.656	.896	2.129	1.572	.281
14S	.8750-20UNEF	.391	1.021	2.201	1.134	.406
14	.8750-20UNEF	.625	1.021	2.524	1.572	.406
16S	1.0000-20UNEF	.391	1.151	2.201	1.134	.500
16	1.0000-20UNEF	.625	1.151	2.524	1.572	.500
18	1.1250-18UNEF	.625	1.242	2.596	1.572	.531
20	1.2500-18UNEF	.625	1.499	2.654	1.572	.656
22	1.3750-18UNEF	.625	1.499	2.654	1.572	.740
24	1.5000-18UNEF	.625	1.781	2.885	1.572	.781
28	1.7500-18UNS	.625	1.781	2.885	1.572	.922
32	2.0000-18UNS	.625	2.087	2.943	1.572	1.156
36	2.2500-16UN	.625	2.281	2.943	1.572	1.250
40	2.5000-16UN	.625	2.581	3.068	1.572	1.562

\* Increase Z dimension by .312 for size "0" contact only.

# MS/Standard MS3102E box mounting receptacle

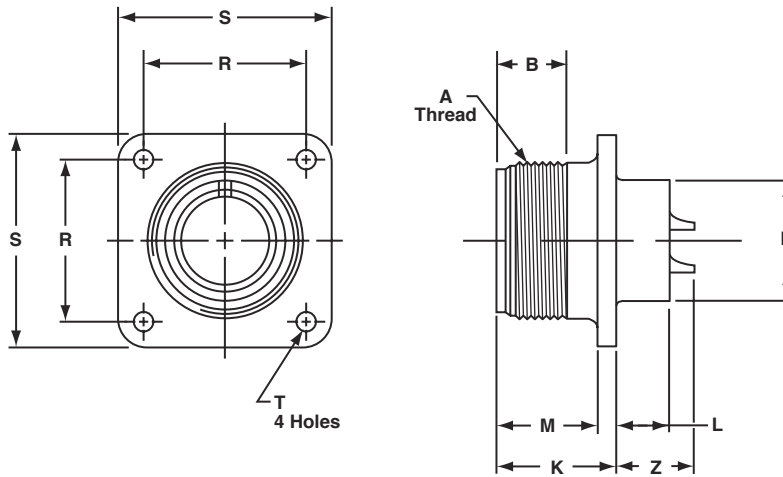

To complete order number, see "how to order" pg. 59.  
For solder well data, see page 29.

Shell Size	A Thread Class 2A	B Min. Full Thread	K +.020 - .010	L +.000 - .010	M +.010 - .000	N Dia. +.010 - .000	R ±.005	S ±.031	T Dia. +.004 - .002	Z +.050 - .060
8S	.5000-28UNEF	.391	.672	.297	.562	.375	.594	.875	.120	.422
10S	.6250-24NEF	.391	.672	.297	.562	.500	.719	1.000	.120	.422
10SL	.6250-24NEF	.391	.672	.297	.562	.625	.719	1.000	.120	.422
12S	.7500-20UNEF	.450	.672	.297	.562	.625	.812	1.094	.120	.422
12	.7500-20UNEF	.625	.860	.484	.750	.625	.812	1.094	.120	.672
14S	.8750-20UNEF	.450	.672	.297	.562	.750	.906	1.188	.120	.422
14	.8750-20UNEF	.625	.860	.484	.750	.750	.906	1.188	.120	.672
16S	1.0000-20UNEF	.450	.672	.297	.562	.875	.969	1.281	.120	.422
16	1.0000-20UNEF	.625	.860	.484	.750	.875	.969	1.281	.120	.672
18	1.1250-18NEF	.625	.891	.453	.750	1.000	1.062	1.375	.120	.641*
20	1.2500-18NEF	.625	.891	.453	.750	1.125	1.156	1.500	.120	.641*
22	1.3750-18NEF	.625	.891	.453	.750	1.250	1.250	1.625	.120	.641*
24	1.5000-18NEF	.625	.953	.453	.812	1.375	1.375	1.750	.147	.578*
28	1.7500-18NS	.625	.953	.453	.812	1.625	1.562	2.000	.147	.578*
32	2.0000-18NS	.625	1.031	.438	.875	1.875	1.750	2.250	.173	.500*
36	2.2500-16UN	.625	1.031	.438	.875	2.062	1.938	2.500	.173	.500*
40	2.5000-16UN	.625	1.031	.438	.875	2.312	2.188	2.750	.173	.500*

\* Increase Z dimension by .312 for size "0" contact only.

# MS/Standard MS3106E/F straight plug

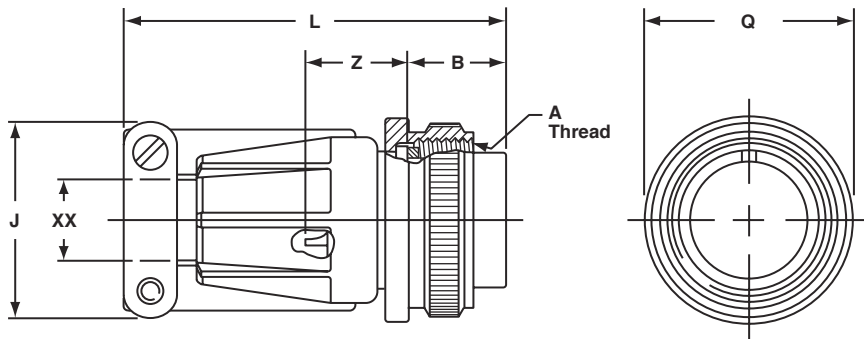

To complete order number, see "how to order" pg. 59.  
For solder well data, see page 29.  
All lockwire holes are .045 dia. min.

Shell Size	A Thread Class 2A	B ±.005	J Max.	L Max.	Q Max.	Z* ±.045	XX Min. Cable Clearance
10SL	.6250-24UNEF	.531	.896	2.129	.946	.607	.281
12S	.7500-20UNEF	.531	.896	2.129	.995	.607	.281
12	.7500-20UNEF	.719	.896	2.129	.995	.857	.281
14S	.8750-20UNEF	.531	1.021	2.201	1.123	.607	.406
14	.8750-20UNEF	.719	1.021	2.524	1.123	.857	.406
16S	1.0000-20UNEF	.531	1.151	2.201	1.250	.607	.500
16	1.0000-20UNEF	.719	1.151	2.524	1.250	.857	.500
18	1.1250-18UNEF	.719	1.242	2.596	1.333	.857	.531
20	1.2500-18UNEF	.719	1.499	2.654	1.461	.857	.656
22	1.3750-18UNEF	.719	1.499	2.654	1.588	.857	.740
24	1.5000-18UNEF	.719	1.781	2.885	1.715	.857	.781
28	1.7500-18UNS	.719	1.781	2.885	1.968	.857	.922
32	2.0000-18UNS	.719	2.087	2.943	2.209	.857	1.156
36	2.2500-16UN	.719	2.281	2.943	2.463	.857	1.250
40	2.5000-16UN	.719	2.581	3.068	2.718	.857	1.562

\* Increase Z dimension by .312 for size "0" contact only.



# MS/Standard MS3108E 90 degree plug

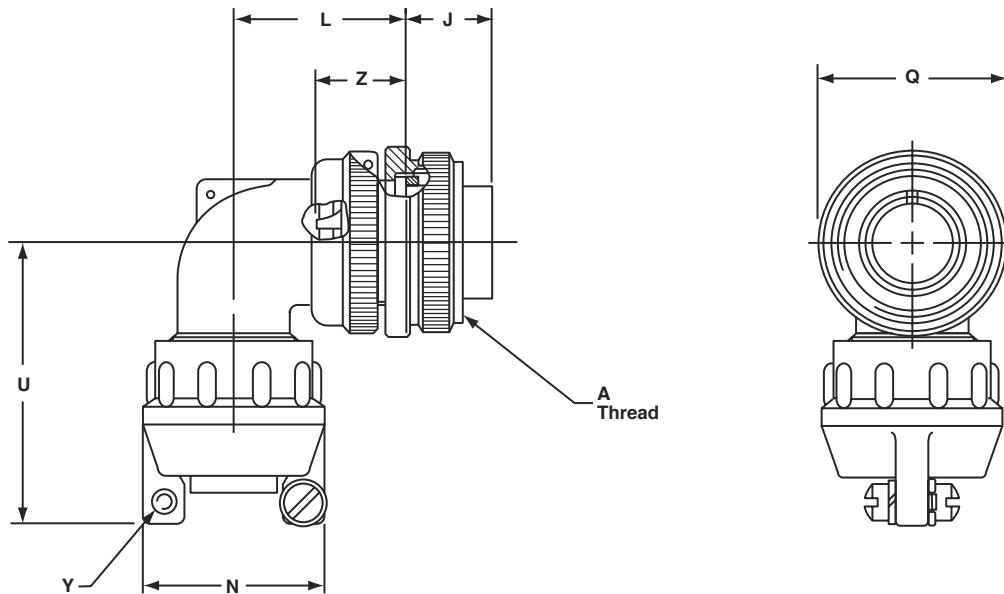

To complete order number, see "how to order" pg. 59.  
For solder well data, see page 29.  
All lockwire holes are .045 dia. min.

Shell Size	A Thread Class 2B	J $\pm.005$	L Max.	N Max.	Q Dia. Max.	U Max.	Y Thread Class 2B	Z $\pm.045$
8S	.5000-28UNEF	.531	.927	.807	.741	1.445	6-32NC	.562
10S	.6250-24NEF	.531	.927	.807	.869	1.445	6-32NC	.562
10SL	.6250-24NEF	.531	.951	.901	.946	1.508	6-32NC	.562
12S	.7500-20UNEF	.531	.956	.901	.995	1.508	6-32NC	.562
12	.7500-20UNEF	.719	1.143	.901	.995	1.508	6-32NC	.812
14S	.8750-20UNEF	.531	1.020	1.026	1.123	1.570	6-32NC	.562
14	.8750-20UNEF	.719	1.207	1.026	1.123	1.570	6-32NC	.812
16S	1.0000-20UNEF	.531	1.146	1.119	1.250	1.633	6-32NC	.562
16	1.1000-20UNEF	.719	1.333	1.119	1.250	1.633	6-32NC	.812
18	1.1250-18NEF	.719	1.395	1.229	1.333	1.759	6-32NC	.812*
20	1.2500-18NEF	.719	1.598	1.479	1.461	1.931	8-32NC	.812*
22	1.3750-18NEF	.719	1.598	1.479	1.588	1.993	8-32NC	.812*
24	1.5000-18NEF	.719	1.786	1.666	1.729	2.119	8-32NC	.812*
28	1.7500-18NS	.719	1.786	1.666	1.968	2.181	8-32NC	.812*
32	2.0000-18NS	.719	2.020	2.135	2.209	2.570	10-32NF	.812*
36	2.2500-16UN	.719	2.145	2.260	2.463	2.695	10-32NF	.812*
40	2.5000-16UN	.719	2.270	2.510	2.719	2.851	10-32NF	.812*

\* Increase Z dimension by .312 for size "0" contact only.

# MS/Standard MS-R



**wall mounting receptacle**

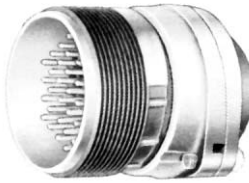

**inline receptacle**



**box mounting receptacle**



**straight plug**

## MS-R

Specification requirements for greater reliability in a shorter, lighter weight environmental resistant connector led to the design of the MS-R. MS Class R connectors satisfy all the performance requirements of SAE AS50151.

This low profile assembly was attained by moving the axial compression nut and grommet assembly forward and flush with the rear of the insert. The neoprene grommet, with its low coefficient of friction, assures easier threading of wire bundles and quicker assembly and serviceability of the unit. Molded webs in each wire hole insure a moisture barrier around each wire.

The addition of an "O" ring at the main joint of all MS3106R plugs provide a main joint seal supplementary to the interfacial seal, thus insuring a higher degree of reliability when connector halves from different sources are employed.

### Shells:

Shell components are fabricated from high grade aluminum alloy. All components have the standard electrically conductive cadmium plated finish with an olive drab chromate after-treatment for corrosion resistance.

### Contacts:

Contacts are machined from copper alloy for maximum corrosion resistance, maximum current carrying capacity and low millivolt drop. Refer to page 54 for additional contact information.

### Inserts:

Resilient neoprene inserts provide an outstanding moisture barrier, maximum vibration resistance and high dielectric strength. Either pin or socket insert can be pressurized.

# MS/Standard MS3100R wall mounting receptacle

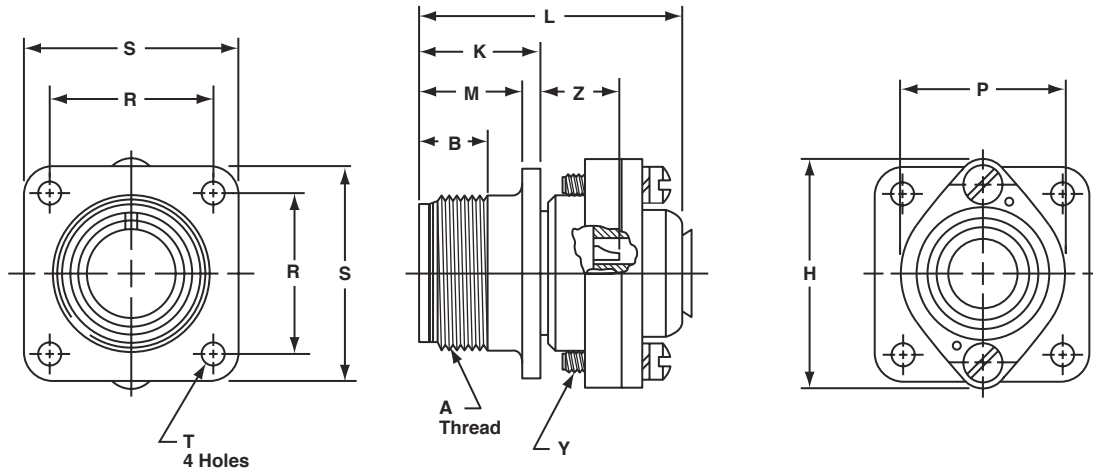

To complete order number, see "how to order" pg. 59.  
For solder well data, see page 29.  
All lockwire holes are .045 dia. min.

Shell Size	A Thread Class 2A	B Min. Full Thread	H Dia. Max.	K +.020 - .010	L Max.	M +.010 - .000	P Dia. Max.	R ±.005	S ±.031	Y Thread Class 2	T Dia. +.004 - .002	Z +.050 - .060
8S	.5000-28UNEF	.391	.959	.672	1.588	.562	.557	.594	.875	6-32NC	.120	.422
10S	.6250-24NEF	.391	1.026	.672	1.588	.562	.682	.719	1.000	6-32NC	.120	.422
10SL	.6250-24NEF	.391	1.120	.672	1.588	.562	.807	.719	1.000	6-32NC	.120	.422
12S	.7500-20UNEF	.450	1.120	.672	1.588	.562	.807	.812	1.094	6-32NC	.120	.422
12	.7500-20UNEF	.625	1.120	.860	1.931	.750	.807	.812	1.094	6-32NC	.120	.672
14S	.8750-20UNEF	.450	1.307	.672	1.588	.562	.932	.906	1.188	6-32NC	.120	.422
14	.8750-20UNEF	.625	1.307	.860	1.931	.750	.932	.906	1.188	6-32NC	.120	.672
16S	1.0000-20UNEF	.450	1.432	.672	1.588	.562	1.057	.969	1.281	6-32NC	.120	.422
16	1.0000-20UNEF	.625	1.432	.860	1.931	.750	1.057	.969	1.281	6-32NC	.120	.672
18	1.1250-18NEF	.625	1.557	.891	1.931	.750	1.182	1.063	1.375	6-32NC	.120	.641*
20	1.2500-18NEF	.625	1.744	.891	1.931	.750	1.291	1.156	1.500	8-32NC	.120	.641*
22	1.3750-18NEF	.625	1.869	.891	1.931	.750	1.432	1.250	1.625	8-32NC	.120	.641*
24	1.5000-18NEF	.625	1.994	.953	2.009	.812	1.557	1.375	1.750	8-32NC	.147	.578*
28	1.7500-18NS	.625	2.166	.953	2.009	.812	1.807	1.562	2.000	8-32NC	.147	.578*
32	2.0000-18NS	.625	2.541	1.031	2.072	.875	2.057	1.750	2.250	10-32NF	.173	.500*
36	2.2500-16UN	.625	2.729	1.031	2.072	.875	2.260	1.938	2.500	10-32NF	.173	.500*
40	2.5000-16UN	.625	2.979	1.031	2.072	.875	2.260	2.510	2.750	10-32NF	.173	.500*

\* Increase Z dimension by .312 for size "0" contact only.

# MS/Standard MS3101R inline receptacle

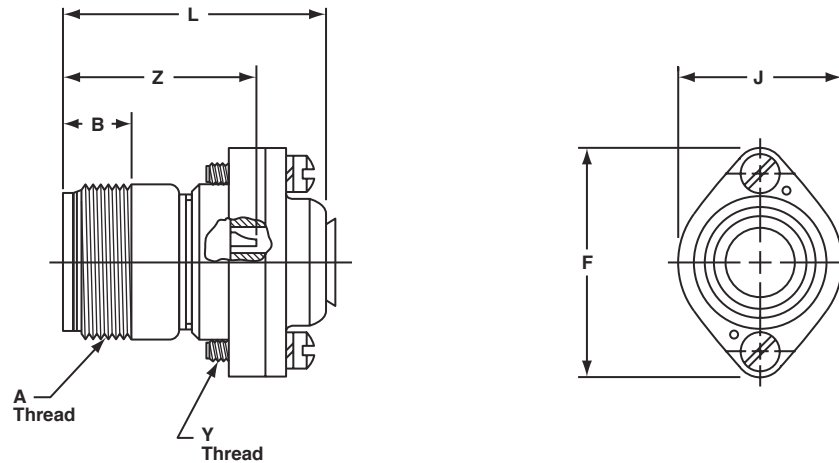

To complete order number, see "how to order" pg. 59.  
For solder well data, see page 29.  
All lockwire holes are .045 dia. min.

Shell Size	A Thread Class 2A	B Min. Full Thread	F Dia. Max.	J Dia. Max.	L Max.	Y Thread Class 2	Z ±.040
8S	.5000-28UNEF	.406	.959	.557	1.588	6-32NC	1.094
10S	.6250-24NEF	.406	1.026	.682	1.588	6-32NC	1.094
10SL	.6250-24NEF	.406	1.120	.807	1.588	6-32NC	1.094
12S	.7500-20UNEF	.422	1.120	.807	1.588	6-32NC	1.094
12	.7500-20UNEF	.656	1.120	.807	1.931	6-32NC	1.532
14S	.8750-20UNEF	.391	1.307	.932	1.588	6-32NC	1.094
14	.8750-20UNEF	.625	1.307	.932	1.931	6-32NC	1.532
16S	1.0000-20UNEF	.391	1.432	1.057	1.588	6-32NC	1.094
16	1.0000-20UNEF	.625	1.432	1.057	1.931	6-32NC	1.532
18	1.1250-18NEF	.625	1.557	1.182	1.931	6-32NC	1.532*
20	1.2500-18NEF	.625	1.744	1.291	1.931	8-32NC	1.532*
22	1.3750-18NEF	.625	1.869	1.432	1.931	8-32NC	1.532*
24	1.5000-18NEF	.625	1.994	1.557	2.009	8-32NC	1.532*
28	1.7500-18NS	.625	2.166	1.807	2.009	8-32NC	1.532*
32	2.0000-18NS	.625	2.541	2.057	2.072	10-32NF	1.532*
36	2.2500-16UN	.625	2.729	2.260	2.072	10-32NF	1.532*
40	2.5000-16UN	.625	2.979	2.510	2.072	10-32NF	1.532*

\* Increase Z dimension by .312 for size "0" contact only.

# MS/Standard MS3102R box mounting receptacle

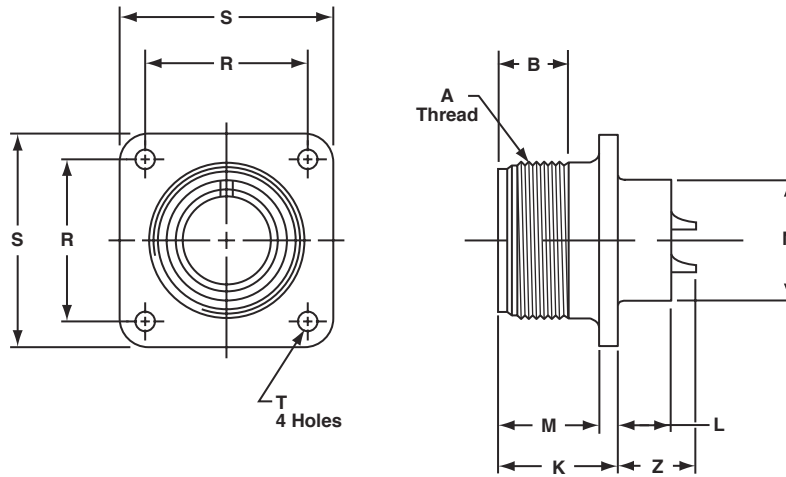

To complete order number, see "how to order" pg. 59.  
For solder well data, see page 29.

Shell Size	A Thread Class 2A	B Min. Full Thread	K +.020 -.010	L +.000 -.010	M +.010 -.000	N Dia. +.010 -.000	R ±.005	S ±.031	T Dia. +.004 -.002	Z +.050 -.060
8S	.5000-28UNEF	.391	.672	.297	.562	.375	.594	.875	.120	.422
10S	.6250-24NEF	.391	.672	.297	.562	.500	.719	1.000	.120	.422
10SL	.6250-24NEF	.391	.672	.297	.562	.625	.719	1.000	.120	.422
12S	.7500-20UNEF	.450	.672	.297	.562	.625	.812	1.094	.120	.422
12	.7500-20UNEF	.625	.860	.484	.750	.625	.812	1.094	.120	.672
14S	.8750-20UNEF	.450	.672	.297	.562	.750	.906	1.188	.120	.422
14	.8750-20UNEF	.625	.860	.484	.750	.750	.906	1.188	.120	.672
16S	1.0000-20UNEF	.450	.672	.297	.562	.875	.969	1.281	.120	.422
16	1.0000-20UNEF	.625	.860	.484	.750	.875	.969	1.281	.120	.672
18	1.1250-18NEF	.625	.891	.453	.750	1.000	1.062	1.375	.120	.641*
20	1.2500-18NEF	.625	.891	.453	.750	1.125	1.156	1.500	.120	.641*
22	1.3750-18NEF	.625	.891	.453	.750	1.250	1.250	1.625	.120	.641*
24	1.5000-18NEF	.625	.953	.453	.812	1.375	1.375	1.750	.147	.578*
28	1.7500-18NS	.625	.953	.453	.812	1.625	1.562	2.000	.147	.578*
32	2.0000-18NS	.625	1.031	.438	.875	1.875	1.750	2.250	.173	.500*
36	2.2500-16UN	.625	1.031	.438	.875	2.062	1.938	2.500	.173	.500*
40	2.5000-16UN	.625	1.031	.438	.875	2.312	2.188	2.750	.173	.500*

\* Increase Z dimension by .312 for size "0" contact only.

# MS/Standard MS3106R straight plug

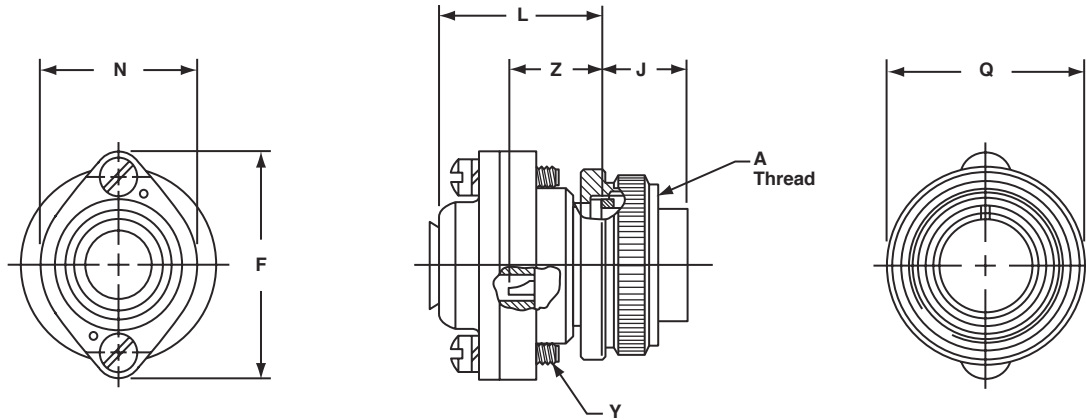

To complete order number, see "how to order" pg. 59.  
For solder well data, see page 29.  
All lockwire holes are .045 dia. min.

Shell Size	A Thread Class 2B	F Dia. Max.	J $\pm.005$	L Max.	N Dia. Max.	Q Dia. Max.	Y Thread Class 2	Z $\pm.045$
8S	.5000-28UNEF	.959	.531	1.057	.557	.741	6-32NC	.562
10S	.6250-24NEF	1.026	.531	1.057	.682	.869	6-32NC	.562
10SL	.6250-24NEF	1.120	.531	1.057	.807	.946	6-32NC	.562
12S	.7500-20UNEF	1.120	.531	1.057	.807	.995	6-32NC	.562
12	.7500-20UNEF	1.120	.719	1.212	.807	.995	6-32NC	.812
14S	.8750-20UNEF	1.307	.531	1.057	.932	1.123	6-32NC	.562
14	.8750-20UNEF	1.307	.719	1.212	.932	1.123	6-32NC	.812
16S	1.0000-20UNEF	1.432	.531	1.057	1.057	1.250	6-32NC	.562
16	1.0000-20UNEF	1.432	.719	1.212	1.057	1.250	6-32NC	.812
18	1.1250-18NEF	1.557	.719	1.212	1.182	1.333	6-32NC	.812*
20	1.2500-18NEF	1.744	.719	1.212	1.291	1.461	8-32NC	.812*
22	1.3750-18NEF	1.869	.719	1.212	1.432	1.588	8-32NC	.812*
24	1.5000-18NEF	1.994	.719	1.291	1.557	1.715	8-32NC	.812*
28	1.7500-18NS	2.166	.719	1.291	1.807	1.968	8-32NC	.812*
32	2.0000-18NS	2.541	.719	1.353	2.057	2.209	10-32NF	.812*
36	2.2500-16UN	2.729	.719	1.353	2.260	2.463	10-32NF	.812*
40	2.5000-16UN	2.979	.719	1.353	2.510	2.719	10-32NF	.812*

\* Increase Z dimension by .312 for size "0" contact only.



# AC Series/MS

## insert availability

Insert Arrangement	Service Rating	Total Contacts	Contact Size				
			0	4	8	12	16
10SL-3	A	3					3
10SL-4†	A	2					2
12S-3	A	2					2
12S-4	D	1					1
12-5	D	1				1	
14S-1	A	3					3
14S-2	Inst.	4					4
14S-4	D	1					1
14S-5	Inst.	5					5
14S-6	Inst.	6					6
14S-7	A	3					3
14S-9	A	2					2
14S-10	Inst.	4					4
14S-12	A	3					3
14S-A7	A	7					7
14-3	A	1			1		
16S-1	A	7					7
16S-3	B	1					1
16S-4	D	2					2
16S-5	A	3					3
16S-6	A	3					3
16S-8	A	5					5
16-2	E	1				1	
16-7	A	3			1		2
16-9	A	4				2	2
16-10	A	3				3	
16-11	A	2				2	
16-12	A	1		1			
16-13	A	2				2	
16-59	A	4				4	
18-1	A/Inst.	10					10
18-3	D	2				2	
18-4	D	4					4
18-5	D	3				2	1
18-6	D	1		1			
18-7	B	1			1		
18-8	A	8				1	7
18-9	Inst.	7				2	5
18-10	A	4				4	
18-11	A	5				5	
18-12	A	6					6
18-13	A	4			1	3	
18-14	A	2		1			1
18-15	A	4				4	
18-16	C	1				1	
18-17	Inst.	7				2	5
18-19	A	10					10
18-20	A	5					5
18-22	D	3					3
18-24	A/Inst.	10					10
18-29	A	5					5

Insert Arrangement	Service Rating	Total Contacts	Contact Size				
			0	4	8	12	16
18-30	A	5					5
18-31	A	5					5
20-2	D	1	1				
20-3	D	3				3	
20-4	D	4				4	
20-6	D	3					3
20-7	D/A	8					8
20-8	Inst.	6			2		4
20-9	D/A	8				1	7
20-11	Inst.	13					13
20-12	A	2		1			1
20-14	A	5			2	3	
20-15	A	7				7	
20-16	A	9				2	7
20-17	A	6				5	1
20-18	A	9				3	6
20-19	A	3			3		
20-20	A	4		1		3	
20-21	A	9				1	8
20-22	A	6			3		3
20-23	A	2			2		
20-24	A	4			2		2
20-25	Inst.	13					13
20-27	A	14					14
20-29	A	17					17
20-30	Inst.	13					13
20-33	A	11					11
20-51	A	3			3		
20-57	A	7				7*	
20-58	A	10				5	5
20-59	A	3			3*		
20-66	A	6				5*	1
20-79	D/A	8				1	7
22-1	D	2			2		
22-2	D	3			3		
22-4	A	4			2	2	
22-5	D	6				2	4
22-6	D	3			2		1
22-7	E	1	1				
22-8	E	2				2	
22-9	E	3				3	
22-10	E	4					4
22-11	B	2					2
22-12	D	5			2		3
22-13	D/A	5				4	1
22-14	A	19					19
22-15	E/A	6				5	1
22-16	A	9				3	6
22-17	D/A	9				1	8
22-18	D/A	8					8

\* Crimp contacts accommodate wire the same size as the contact as well as wire of the next smaller, even size. Arrangements identified with an asterisk (\*) are exceptions. See insert arrangement drawings on pages 32-53 for application wire size.

# AC Series/MS

## insert availability, cont.

Insert Arrangement	Service Rating	Total Con-tacts	Contact Size													
			4/0	2/0	0	4	8	12	16	Coax**						
										0	4	8	12			
22-19	A	14										14				
22-20	A	9										9				
22-21	A	3			1							2				
22-22	A	4					4									
22-23	D/A	8									8					
22-24	D/A	6									2	4				
22-27	D/A	9						1				8				
22-28	A	7									7					
22-33	D/A	7										7				
22-34	D	5									3	2				
22-36	D/A	8									8					
22-63	A	12									4	8				
22-65	D/A	8									8*					
22-70	A	13									8	5				
22-80	A	3						3*								
24-2	D	7									7					
24-3	D	7									2	5				
24-5	A	16										16				
24-6	D/A	8									8					
24-7	A	16									2	14				
24-9	A	2				2										
24-10	A	7						7								
24-11	A	9						3	6							
24-12	A	5				2			3							
24-16	D/A	7					1	3	3							
24-17	D	5							2	3						
24-19	A	12										12				
24-20	D	11								2	9					
24-21	D	10						1			9					
24-22	D	4						4								
24-27	E	7									7					
24-28	Inst.	24										24				
24-51	A	5						5								
24-52	Hi-Volt	1							1							
24-53	A	5						5								
24-58	A	13						3	3	7						
24-59	A	14								7	7					
24-60	A	7						7*								
24-65	A	15								11	4					
24-66	D	7								7						
24-67	Inst.	19									19					
24-71	A	7						7*								
24-75	A	7						7*								
24-79	A	5						5								
24-80	Inst.	23									23					
24-84	A	19								1						18
24-96	Inst.	28										28				
24-AJ	A	25										25				
28-1	D/A	9							3	6						
28-2	D	14								2	12					

Insert Arrangement	Service Rating	Total Con-tacts	Contact Size													
			4/0	2/0	0	4	8	12	16	Coax**						
										0	4	8	12			
28-3	E	3										3				
28-4	E/D	9											2	7		
28-5	D	5									2		1	2		
28-6	D	3									3					
28-7	D	2									2					
28-8	E/D/A	12											2	10		
28-9	D	12											6	6		
28-10	D/A	7									2	2	3			
28-11	A	22											4	18		
28-12	A	26												26		
28-13	A	26												26		
28-15	A	35												35		
28-16	A	20												20		
28-17	B/D/A	15												15		
28-18	C/D/A/Inst.	12												12		
28-19	B/D/A	10											4	6		
28-20	A	14											10	4		
28-21	A	37												37		
28-22	D	6									3			3		
28-51	A	12												12		
28-59	A	17												7	10	
28-66	A	16										2	14			
28-72	Coax	3														3
28-74	A	16										7*		9		
28-75	A	16										7*		9		
28-79	A	16										7		9		
28-82	D	6										2	4			
28-84	A	9										9				
28-AY	A	9									4			5		
32-1	E/D	5							2				3			
32-2	E	5									3			2		
32-3	D	9							1	2			2	4		
32-4	A/D	14											2	12		
32-5	D	2							2							
32-6	A	23									2	3	2	16		
32-7	Inst./A	35												7	28	
32-8	A	30												6	24	
32-9	D	14									2			12		
32-10	E/B/D/A	7									2	2		3		
32-12	A/D	15												5	10	
32-13	D	23												5	18	
32-14	D	13												13		
32-15	D	8								2				6		
32-16	A	23									2	3	2	16		
32-17	D	4									4					
32-22	A	54												54		
32-25	A	25												25		
32-31	A	31												31		
32-48	Inst.	48												48		
32-52	D	8								2				6		
32-53	Inst./E	42												5	37	

\* Crimp contacts accommodate wire the same size as the contact as well as wire of the next smaller, even size. Arrangements identified with an asterisk (\*) are exceptions. See insert arrangement drawings on pages 32-53 for application wire size.

# AC Series/MS

## insert availability, cont.

Insert Arrange ment	Service Rating	Total Con- tacts	Contact Size											
			4/0	2/0	0	4	8	12	16	Coax**				
										0	4	8	12	
32-56	A	30							6*	24				
32-57	Coax	8							6		2			
32-58	Coax	4									4			
32-59	A	42								40		2		
32-60	A	23								15		8		
32-62	Coax	23				2	1		2	16		2		
32-64	Inst.	54								54				
32-68	A	16								12	4			
32-73	A	46								46				
32-75	Coax	9							2			7		
32-76	A	19								19				
32-79	D	5				4	1							
32-82	A	16				4				12				
32-AF	A	55								55				
36-1	D	22								4	18			
36-3	D	6			3				3					
36-4	D/A	3			3									
36-5	A	4			4									
36-6	A	6			2	4								
36-7	A	47							7	40				
36-8	A	47							1	46				
36-9	A	31				1	2		14	14				
36-10	A	48								48				
36-11	A	48								48				
36-12	A	48								48				
36-13	E/A	17							2	15				
36-14	D	16						5	5	6				
36-15	D/A	35								35				
36-16	A	47							7	40				
36-17	A	47							7	40				
36-18	A	31				1	2		14	14				
36-20	A	34							2	2	30			
36-51	D	4			2	2								
36-52	A	52								52				
36-54	A	39							8	31				
36-55	A	39							8*	31				
36-59	A	53								3*	50			
36-60	A	47								7*	40			
36-64	Coax	4									4			
36-65	Coax	4									4			
36-71	A	53								3	50			
36-73	Coax	7										7		
36-74	A	44								43		1		
36-75	A	48								48*				
36-76	A	47								47				
36-77	D	7				7								
36-78	A	14							12		2			
36-79	A	20								20				
36-80	A	20								20*				

Insert Arrange ment	Service Rating	Total Con- tacts	Contact Size											
			4/0	2/0	0	4	8	12	16	Coax**				
										0	4	8	12	
36-83	Coax	7												7
36-85	A/D	35											35*	
36-97	C	1	1											
36-99	D	12					3	3	3	3				
36-AF	A	48											48	
40-1	D	30										6	24	
40-5	A	5				5								
40-9	A	47							1	22	24			
40-10	A	29						4	9				16	
40-30	A	30						1		29				
40-35	D	35										35		
40-53	A	60											60	
40-56	A	85											85	
40-57	E	4				4								
40-61	A	59							1	3	55			
40-62	A	60											60	
40-63	A	61											61*	
40-64	Coax	36								3	20			13
40-66	Coax	4											4	
40-67	A	11									1			10
40-68	A	21							21					
40-70	A	61											61	
40-72	A	11									1			10
40-73	A	61											61	
40-74	A	6								1		4	1	
40-75	E	5				4				1				
40-80	A	11							10				1	
40-81	A	62											62*	
40-82	A	62											62	
40-85	A	60											60	
40-86	E	4											4	
40-87	D	7							7					
40-AD	A	8				4				4				
40-AG	A	38										38		
40-AP	E	2	2											
40-AR	Inst.	13						3	3		7			
40-AS	A	40									25	15		
40-AT	A	43								1	24	18		
40-AU	A	14							3	10		1		
40-AV	D	3				3								

\* Crimp contacts accommodate wire the same size as the contact as well as wire of the next smaller, even size. Arrangements identified with an asterisk (\*) are exceptions. See insert arrangement drawings on pages 32-53 for application wire size.

# AC Series/MS

## insert alternate positioning

To avoid cross-plugging problems in applications requiring the use of more than one connector of the same size and arrangement, alternate rotations are available as indicated in the accompanying charts.

As shown in the diagram below, the front face of the pin insert is rotated within the shell in a clockwise direction from the normal shell key. The socket insert would be rotated counter-clockwise the same number of degrees in respect to the normal shell key.

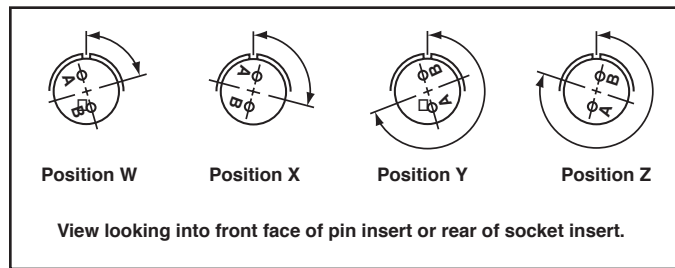

The following insert arrangements have the same alternate insert rotations for W, X, Y and Z, which are:

Degrees			
W	X	Y	Z
80	110	250	280

16-7	20-20	22-21	24-7	28-8	32-1	36-1
18-5	20-22	22-24	24-12	28-9	32-3	36-7
18-9	22-3	22-25	24-14	28-10	32-4	36-8
18-13	22-6	22-29	24-16	28-11	32-6	36-13
18-14	22-12	22-33	24-17	28-14	32-9	40-AR
20-7	22-14	22-34	24-20	28-15	32-10	40-AS
20-8	22-15	24-1	24-21	28-16	32-12	40-AT
20-9	22-16	24-3	24-28	28-17	32-13	40-AU
20-12	22-17	24-4	24-AJ	28-19	32-22	
20-14	22-18	24-5	28-1	28-20	32-31	
20-16	22-19	24-6	28-4	28-21	32-AF	

Insert Arrangement	Degrees			
	W	X	Y	Z
10-SL-4	63	-	-	-
12S-3	70	145	215	290
14S-2	-	120	240	-
14S-5	-	110	-	-
14S-7	90	180	270	-
14S-9	70	145	215	290
16-9	35	110	250	325
16-10	90	180	270	-
16-11	35	110	250	325
16-13	35	110	250	325
16S-1	80	-	-	280
16S-4	35	110	250	325
16S-5	70	145	215	290
16S-6	90	180	270	-
16S-8	-	170	265	-
18-1	70	145	215	290
18-3	35	110	250	325
18-4	35	110	250	325
18-8	70	-	-	290
18-10	-	120	240	-
18-11	-	170	265	-
18-12	80	-	-	280
18-15	-	120	240	-
18-20	90	180	270	-
18-22	70	145	215	290
18-29	90	180	270	-
20-3	70	145	215	290
20-4	45	110	250	-
20-5	35	110	250	325
20-6	70	145	215	290
20-15	80	-	-	280
20-17	90	180	270	-
20-18	35	110	250	325

Insert Arrangement	Degrees			
	W	X	Y	Z
20-19	90	180	270	-
20-21	35	110	250	325
20-23	35	110	250	325
20-24	35	110	250	325
20-27	35	110	250	325
20-29	80	-	-	280
22-1	35	110	250	325
22-2	70	145	215	290
22-4	35	110	250	325
22-5	35	110	250	325
22-8	35	110	250	325
22-9	70	145	215	290
22-10	35	110	250	325
22-11	35	110	250	325
22-13	35	110	250	325
22-20	35	110	250	325
22-22	-	110	250	-
22-23	35	-	250	-
22-27	80	-	250	280
22-28	80	-	-	280
22-63	20	-	-	-
24-2	80	-	-	280
24-9	35	110	250	325
24-10	80	-	-	280
24-11	35	110	250	325
24-22	45	110	250	-
24-27	80	-	-	280
28-2	35	110	250	325
28-3	70	145	215	290
28-5	35	110	250	325
28-6	70	145	215	290
28-7	35	110	250	325
28-12	90	180	270	-

Insert Arrangement	Degrees			
	W	X	Y	Z
28-18	70	145	215	290
28-22	70	145	215	290
28-AY	45	110	250	-
32-2	70	145	215	290
32-5	35	110	250	325
32-7	80	125	235	280
32-8	80	125	235	280
32-14	65	130	230	295
32-15	35	110	250	280
32-17	45	110	250	-
32-25	60	120	-	-
32-48	80	-	-	-
32-64	80	100	110	250
32-68	30	-	-	-
32-82	30	-	-	-
36-3	70	145	215	290
36-4	70	145	215	290
36-5	-	120	240	-
36-6	35	110	250	325
36-9	80	125	235	280
36-10	80	125	235	280
36-14	90	180	270	-
36-15	60	125	245	305
36-AF	65	-	-	-
40-1	65	130	235	300
40-5	33	-	-	270
40-9	65	125	225	310
40-10	65	125	225	310
40-35	70	130	230	290
40-AD	45	-	-	-
40-AG	37	74	285	322
40-AP	35	110	250	325
40-AV	90	180	270	-

# AC Series/MS solder contacts

Machined copper alloy contacts in a full range of sizes, with closed entry socket design in the size 12 and 16 contacts. A heavy silver-plated finish is deposited on all solder contacts for maximum corrosion resistance, maximum current carrying capacity and low millivolt drop.

## SOLDER CONTACTS\*

Pin/ Socket	Mating End Size	Wire Barrel Size	Allowable Wire Size	Test Current** Amps
Pin	16 Short†	16	16	13
Socket			18	10
			20	7.5
			22	5
Pin	16 Long	16	16	13
Socket			18	10
			20	7.5
			22	5
Pin	12	12	12	23
Socket			14	17
Pin	8	8	8	46
Socket			10	33
Pin	4	4	4	80
Socket			6	60
Pin	0	0	0	150
Socket			1	125
			2	100

\* Solder Wells Filled

\*\* Contact ratings as stated are test ratings only. The connector may not withstand full rated current through all contacts continuously. Please note that the electrical data given is not an establishment of electrical safety factors. This is left entirely in the designer's hands as he can best determine which peak voltage, switching surges, transients, etc. can be expected in a particular circuit.

† The 10SL, 12S, 14S and 16S connectors require short contacts.

## CONTACT ARRANGEMENT SERVICE RATING

MS Service Rating	Recommended Operating Voltage* at Sea Level		Effective Creepage Distance Nom.	Mechanical Spacing Nom.
	D C	AC (RMS)		
Inst.	250	200	1/16	
A	700	500	1/8	1/16
D	1250	900	3/16	1/8
E	1750	1250	1/4	3/16
B	2450	1750	5/16	1/4
C	4200	3000	1	5/16

\* The values listed in Table I represent operating values which include a generous safety factor. It may be necessary for some applications to exceed the operating voltages listed here. If this is necessary, designers will find Table II useful for determining the degree to which the recommended values of Table I can be exceeded.

## ALTITUDE VOLTAGE DERATING\*\* CHART

MS Service Rating	Nominal Distance		Standard Sea Level Conditions		Pressure Altitude † 50,000 Feet		Pressure Altitude † 70,000 Feet	
	Airspace	Creepage	Minimum Flashover Voltage	Test Voltage	Minimum Flashover Voltage	Test Voltage	Minimum Flashover Voltage	Test Voltage
			AC (RMS)	AC (RMS)	AC (RMS)	AC (RMS)	AC (RMS)	AC (RMS)
Inst.	1/32	1/16	1400	1000	550	400	325	260
A	1/16	1/8	2800	2000	800	600	450	360
D	1/8	3/16	3600	2800	900	675	500	400
E	3/16	1/4	4500	3500	1000	750	550	440
B	1/4	5/16	5700	4500	1100	825	600	480
C	5/16	1	8500	7000	1300	975	700	560

† Not corrected for changes in density due to variations in temperature

\*\* No attempt has been made to recommend operating voltages. The designer must determine his own operating voltage by the application of a safety factor to the above derating chart to compensate for circuit transients, surges, etc.

# AC Series/MS crimp contacts

Machined from copper alloys and silver-plated for maximum corrosion resistance, with a minimum millivolt drop and a maximum current carrying capacity, the size 16 and 12 socket contacts are of the closed entry design. Crimp contacts are available for all insert arrangements and are identified with a Amphenol® proprietary number. Gold plated contacts are also available. (See how to order on page 59).

## CRIMP CONTACTS\*

Part Number	Pin/Socket	Mating End Size	Wire Barrel Size	Allowable Wire Size	Required Wire Adapter Sleeve	Test Current** Amps
10-40553	Pin	16 Short†	16	16	–	13
10-597109-161	Socket			18	–	10
				20	–	7.5
				22*	10-74696-6	5
10-40557	Pin	16 Long	16	16	–	13
10-597109-171	Socket			18	–	10
				20	–	7.5
				22*	10-74696-6	5
10-40561	Pin	12	12	12	–	23
10-597109-131	Socket			14	–	17
10-40792	Pin	8	8	8	–	46
10-40793	Socket			10*	10-74696-1	33
10-40564	Pin	4	4	4	–	80
10-40565	Socket			6*	10-74696-2	60
10-581806-000	Pin	0	0	0	–	150
10-581808-000	Socket			2*	10-74696-7	125

\* When using wire adapter sleeve shown

\*\* Contact ratings as stated are test ratings only. The connector may not withstand full rated current through all contacts continuously. Please note that the electrical data given is not an establishment of electrical safety factors. This is left entirely in the designer's hands as he can best determine which peak voltage, switching surges, transients, etc. can be expected in a particular circuit.

† The 10SL, 12S, 14S and 16S connectors require short contacts.

Additional contact variations are available; consult Amphenol, Sidney NY for information.

## CONTACT ARRANGEMENT SERVICE RATING

MS Service Rating	Recommended Operating Voltage* at Sea Level		Effective Creepage Distance Nom.	Mechanical Spacing Nom.
	D C	AC (RMS)		
Inst.	250	200	1/16	
A	700	500	1/8	1/16
D	1250	900	3/16	1/8
E	1750	1250	1/4	3/16
B	2450	1750	5/16	1/4
C	4200	3000	1	5/16

## ALTITUDE VOLTAGE DERATING\*\* CHART

MS Service Rating	Nominal Distance		Standard Sea Level Conditions		Pressure Altitude † 50,000 Feet		Pressure Altitude† 70,000 Feet	
	Airspace	Creepage	Minimum Flashover Voltage	Test Voltage	Minimum Flashover Voltage	Test Voltage	Minimum Flashover Voltage	Test Voltage
			AC (RMS)	AC (RMS)	AC (RMS)	AC (RMS)	AC (RMS)	AC (RMS)
Inst.	1/32	1/16	1400	1000	550	400	325	260
A	1/16	1/8	2800	2000	800	600	450	360
D	1/8	3/16	3600	2800	900	675	500	400
E	3/16	1/4	4500	3500	1000	750	550	440
B	1/4	5/16	5700	4500	1100	825	600	480
C	5/16	1	8500	7000	1300	975	700	560

† Not corrected for changes in density due to variations in temperature.

\*\* No attempt has been made to recommend operating voltages. The designer must determine his own operating voltage by the application of a safety factor to the above derating chart to compensate for circuit transients, surges, etc.

# RADSOK® Technology

## RADSOK® Technology Advantages

RADSOK'S twisted grid configuration allows for 50% more current to pass through the same size pin, while providing increased reliability, ampacity and cycle durability as well as lower insertion force, T-rise and voltage drop.

### • HIGH RELIABILITY

Unique RADSOK® design and construction technology create an electrical contact interface that exceeds typical interconnect requirements. Applications in aerospace, medical, industrial, automotive, mining, offshore, and other harsh environments depend on the high reliability of Amphenol's RADSOK® technology.

### • LOW CONTACT ENGAGEMENT/SEPARATION FORCES

The hyperbolic lamella socket contact construction distributes normal forces over a high percentage of the mating pin surface. This creates a smooth, even engagement effort. This force distribution also contributes to excellent performance in vibration applications with resistance to typical fretting corrosion.

### • LOW CONTACT RESISTANCE

The large interface area between the socket lamella and pin surface result in very low contact resistance, enabling the RADSOK® contacts' high current ratings compared to traditional power contact designs.

### • HIGH MATING CYCLE DURABILITY

RADSOK® contacts with typical silver plating finishes have demonstrated survival of 20,000 mating cycles. Specialized plating and contact lubricants can extend cycle life to 200,000 matings or higher. Even with continuous exposure to harsh environmental abuse (salt, sand, and high humidity), RADSOK® contacts have been tested to maintain low contact resistance beyond 10,000 mating cycles.

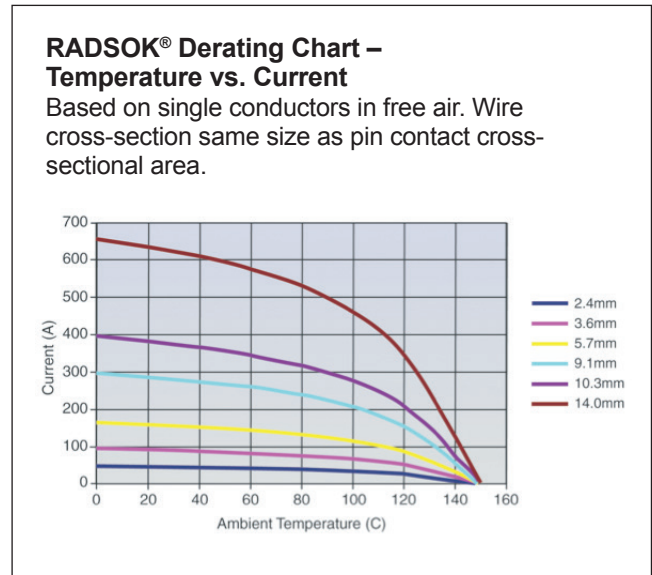

## RADSOK® Socket Table

CRIMP CONTACT DATA						
RADSOK® Part Number		Mating Size	Wire Barrell Size	Allowable Wire Size	Required Wire Adapter Sleeve	Test Current** AMPS
Socket Contact						
Silver	Gold					
10-639140-121	10-639140-1231	12	12-14	12 14	- -	35 ***
10-639140-081	10-639140-0831	8	8	8 10*	- 10-74696-1	70 ***
10-639140-041	10-639140-0431	4	4	4 6*	- 10-74696-2	120 ***
10-639140-001	10-639140-0031	0	0	0 2*	- 10-74696-7	250 ***

\* When using wire adapter sleeve shown

\*\* Contact ratings as stated are test ratings only. The connector may not withstand full rated current through all contacts continuously. Please note that the electrical data given is not an establishment of electrical safety factors. This is left entirely in the designer's hands as he can best determine which peak voltage, switching surges, transients, etc. can be expected in a particular circuit.

\*\*\* Consult Amphenol Industrial for test current at these wire sizes.

# AC Series/MS

## contact arrangements

front face of pin insert or rear face of socket insert illustrated

	Front of Socket Insert	Front of Socket Insert					
<b>Insert Arrangement</b>	<b>10SL-3</b>	<b>10SL-4</b>	<b>12S-3</b>	<b>12S-4</b>	<b>12-5</b>	<b>14S-1</b>	<b>14S-2</b>
<b>Service Rating</b>	<b>A</b>	<b>A</b>	<b>A</b>	<b>D</b>	<b>D</b>	<b>A</b>	<b>Inst.</b>
<b>Number of Contacts</b>	<b>3</b>	<b>2</b>	<b>2</b>	<b>1</b>	<b>1</b>	<b>3</b>	<b>4</b>
<b>Contact Size</b>	<b>16</b>	<b>16</b>	<b>16</b>	<b>16</b>	<b>12</b>	<b>16</b>	<b>16</b>
						100° Rotation of 14S-2	
<b>Insert Arrangement</b>	<b>14S-4</b>	<b>14S-5</b>	<b>14S-6</b>	<b>14S-7</b>	<b>14S-9</b>	<b>14S-10</b>	
<b>Service Rating</b>	<b>D</b>	<b>Inst.</b>	<b>Inst.</b>	<b>A</b>	<b>A</b>	<b>Inst.</b>	
<b>Number of Contacts</b>	<b>1</b>	<b>5</b>	<b>6</b>	<b>3</b>	<b>2</b>	<b>4</b>	
<b>Contact Size</b>	<b>16</b>	<b>16</b>	<b>16</b>	<b>16</b>	<b>16</b>	<b>16</b>	
	100° Rotation of 14S-7						
<b>Insert Arrangement</b>	<b>14S-12</b>	<b>14S-A7</b>	<b>14-3</b>	<b>16S-1</b>	<b>16S-3</b>	<b>16S-4</b>	
<b>Service Rating</b>	<b>A</b>	<b>A</b>	<b>A</b>	<b>A</b>	<b>B</b>	<b>D</b>	
<b>Number of Contacts</b>	<b>3</b>	<b>7</b>	<b>1</b>	<b>7</b>	<b>1</b>	<b>2</b>	
<b>Contact Size</b>	<b>16</b>	<b>16</b>	<b>8</b>	<b>16</b>	<b>16</b>	<b>16</b>	
<b>Insert Arrangement</b>	<b>16S-5</b>	<b>16S-6</b>	<b>16S-8</b>	<b>16-2</b>	<b>16-7</b>	<b>16-9</b>	
<b>Service Rating</b>	<b>A</b>	<b>A</b>	<b>A</b>	<b>E</b>	<b>A</b>	<b>A</b>	
<b>Number of Contacts</b>	<b>3</b>	<b>3</b>	<b>5</b>	<b>1</b>	<b>1 2</b>	<b>2 2</b>	
<b>Contact Size</b>	<b>16</b>	<b>16</b>	<b>16</b>	<b>12</b>	<b>8 16</b>	<b>12 16</b>	
					<b>CONTACT LEGEND</b>	<b>16 12 8 4 0</b>	



# AC Series/MS

## contact arrangements

front face of pin insert or rear face of socket insert illustrated

<b>Insert Arrangement</b>	<b>16-10</b>	<b>16-11</b>	<b>16-12</b>	<b>16-13</b>	<b>16-59</b>	<b>18-1</b>
<b>Service Rating</b>	<b>A</b>	<b>A</b>	<b>A</b>	<b>A</b>	<b>A</b>	<b>B, C, F, G = A; bal. = Inst.</b>
<b>Number of Contacts</b>	<b>3</b>	<b>2</b>	<b>1</b>	<b>2*</b>	<b>4</b>	<b>10</b>
<b>Contact Size</b>	<b>12</b>	<b>12</b>	<b>4</b>	<b>12</b>	<b>12</b>	<b>16</b>

<b>Insert Arrangement</b>	<b>18-3</b>	<b>18-4</b>	<b>18-5</b>	<b>18-6</b>	<b>18-7</b>	<b>18-8</b>
<b>Service Rating</b>	<b>D</b>	<b>D</b>	<b>D</b>	<b>D</b>	<b>B</b>	<b>A</b>
<b>Number of Contacts</b>	<b>2</b>	<b>4</b>	<b>2 1</b>	<b>1</b>	<b>1</b>	<b>1 7</b>
<b>Contact Size</b>	<b>12</b>	<b>16</b>	<b>12 16</b>	<b>4</b>	<b>8</b>	<b>12 16</b>

<b>Insert Arrangement</b>	<b>18-9</b>	<b>18-10</b>	<b>18-11</b>	<b>18-12</b>	<b>18-13</b>	<b>18-14</b>
<b>Service Rating</b>	<b>Inst.</b>	<b>A</b>	<b>A</b>	<b>A</b>	<b>A</b>	<b>A</b>
<b>Number of Contacts</b>	<b>2 5</b>	<b>4</b>	<b>5</b>	<b>6</b>	<b>1 3</b>	<b>1 1</b>
<b>Contact Size</b>	<b>12 16</b>	<b>12</b>	<b>12</b>	<b>16</b>	<b>8 12</b>	<b>4 16</b>

<b>Insert Arrangement</b>	<b>18-15</b>	<b>18-16</b>	<b>18-17</b>	<b>18-19</b>	<b>18-20</b>	<b>18-22</b>
<b>Service Rating</b>	<b>A</b>	<b>C</b>	<b>Inst.</b>	<b>A</b>	<b>A</b>	<b>D</b>
<b>Number of Contacts</b>	<b>4**</b>	<b>1</b>	<b>2 5</b>	<b>10</b>	<b>5</b>	<b>3</b>
<b>Contact Size</b>	<b>12</b>	<b>12</b>	<b>12 16</b>	<b>16</b>	<b>16</b>	<b>16</b>

\*A = Iron; B = Constantan  
 \*\*A, C = Iron; B, D = Constantan

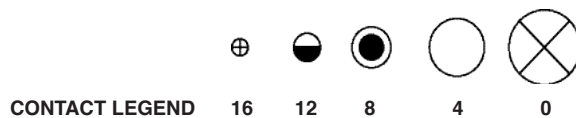

# AC Series/MS contact arrangements

front face of pin insert or rear face of socket insert illustrated

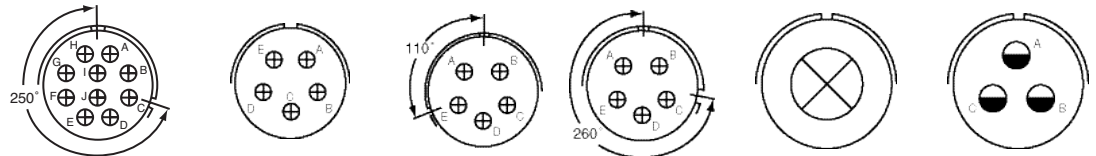

Insert Arrangement	18-24	18-29	18-30	18-31	20-2	20-3
Service Rating	B, C, F, G = A; Bal. = Inst.	A	A	A	D	D
Number of Contacts	10	5	5	5	1	3
Contact Size	16	16	16	16	0	12

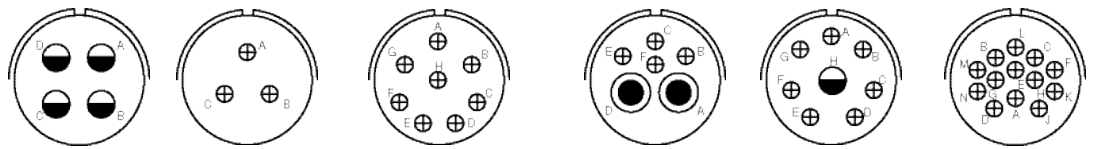

Insert Arrangement	20-4	20-6	20-7	20-8	20-9	20-11
Service Rating	D	D	A, B, H, G = D; C, D, E, F = A	Inst.	H = D; Bal. = A	Inst.
Number of Contacts	4	3	8	2 4	1 7	13
Contact Size	12	16	16	8 16	12 16	16

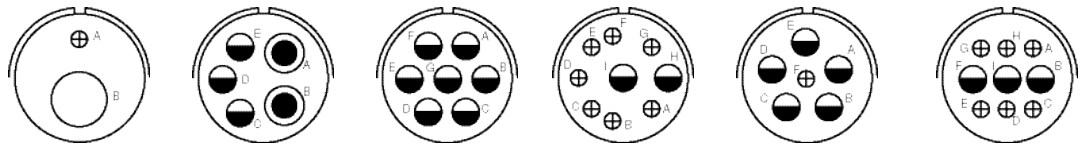

Insert Arrangement	20-12	20-14	20-15	20-16	20-17	20-18
Service Rating	A	A	A	A	A	A
Number of Contacts	1 1	2 3	7	2 7	5 1	3 6
Contact Size	4 16	8 12	12	12 16	12 16	12



CONTACT LEGEND 16 12 8 4 0

# AC Series/MS contact arrangements

front face of pin insert or rear face of socket insert illustrated

<b>Insert Arrangement</b>	20-19	20-20	20-21	20-22	20-23	20-24
<b>Service Rating</b>	A	A	A	A	A	A
<b>Number of Contacts</b>	3	1 3	1 8	3 3	2	2 2
<b>Contact Size</b>	8	4 12	12 16	8 16	8	8 16

<b>Insert Arrangement</b>	100° Rotation of 20-11 20-25	20-27	20-29	250° Rotation of 20-11 20-30	20-33	20-51
<b>Service Rating</b>	Inst.	A	A	Inst.	A	A
<b>Number of Contacts</b>	13	14	17	13	11	3*
<b>Contact Size</b>	16	16	16	16	16	8

<b>Insert Arrangement</b>	20-57	20-58	20-59	20-66	20-79
<b>Service Rating</b>	A	A	A	A	H = D; Bal. = A
<b>Number of Contacts</b>	7*	5 5	3*	1 5	7* 1*
<b>Contact Size</b>	12 for #14 or 16 wire	12 16	8 for #10 or 12 wire	16 12 for #10 wire	16 12 for #16 wire

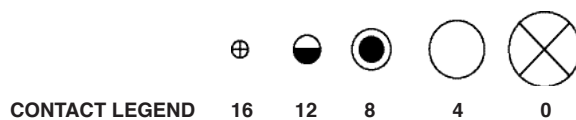

# AC Series/MS

## contact arrangements

front face of pin insert or rear face of socket insert illustrated

<b>Insert Arrangement</b>	22-1	22-2	22-4	22-5	22-6	22-7
<b>Service Rating</b>	D	D	A	D	D	E
<b>Number of Contacts</b>	2	3	2 2	2 4	2 1	1
<b>Contact Size</b>	8	8	8 12	12 16	8 16	0
<b>Insert Arrangement</b>	22-8	22-9	22-10	22-11	22-12	22-13
<b>Service Rating</b>	E	E	E	B	D	E = D; A, B, C, D = A
<b>Number of Contacts</b>	2	3	4	2	2 3	4 1
<b>Contact Size</b>	12	12	16	16	8 16	12 16
<b>Insert Arrangement</b>	22-14	22-15	22-16	22-17	22-18	
<b>Service Rating</b>	A	D = E; A, B, C, E, F = A	A	A = D; Bal. = A	A, B, F, G, H = D; C, D, E = A	
<b>Number of Contacts</b>	19	5 1	3 6	1 8	8	
<b>Contact Size</b>	16	12 16	12 16	12 16	16	

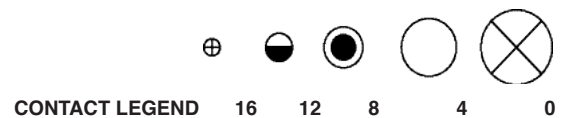

# AC Series/MS contact arrangements

front face of pin insert or rear face of socket insert illustrated

<b>Insert Arrangement</b>	22-19	22-20	22-21	22-22	22-23
<b>Service Rating</b>	A	A	A	A	H = D; Bal = A
<b>Number of Contacts</b>	14	9	1 2	4	8
<b>Contact Size</b>	16	16	0 16	8	12
<b>Insert Arrangement</b>	22-24	22-27	22-28	22-33	22-34
<b>Service Rating</b>	C, D, E = D; A, B, F = A	J = D; Bal. = A	A	A, B, C, D = D; E, F, G = A	D
<b>Number of Contacts</b>	2 4	1 8	7	7	3 2
<b>Contact Size</b>	12 16	8 16	12	16	12 16
<b>Insert Arrangement</b>	22-36	22-63	22-65	22-70	22-80
<b>Service Rating</b>	H = D; Bal. = A**	A	H = D; Bal. = A	A	A
<b>Number of Contacts</b>	8	4 8	8*	8 5	3*
<b>Contact Size</b>	12	12 16	12 for #14 or 16 wire	12 16	8 for #10 or 12 wire

\* Solderless

\*\* A, C, E, G = Iron

B, D, F, H = Constantan

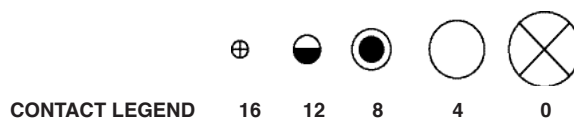

# AC Series/MS

## contact arrangements

front face of pin insert or rear face of socket insert illustrated

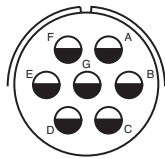

**24-2**  
D  
7  
12

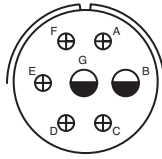

**24-3**  
D  
2 5  
12 16

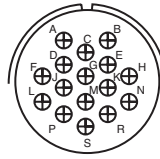

**24-5**  
A  
16  
16

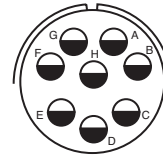

**24-6**  
A, G, H = D; Bal. = A  
8  
12

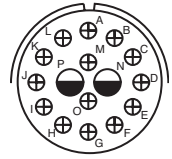

**24-7**  
A  
2 14  
12 16

Insert Arrangement  
Service Rating  
Number of Contacts  
Contact Size

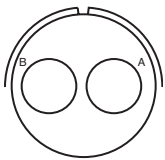

**24-9**  
A  
2  
4

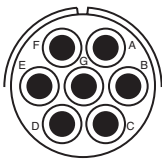

**24-10**  
A  
7  
8

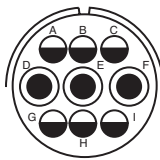

**24-11**  
A  
3 6  
8 12

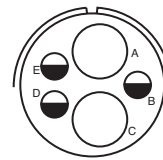

**24-12**  
A  
2 3  
4 12

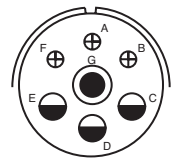

**24-16**  
A, B, F, G = D; C, D, E = A  
1 3 3  
8 12 16

Insert Arrangement  
Service Rating  
Number of Contacts  
Contact Size

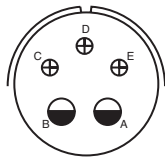

**24-17**  
D  
2 3  
12 16

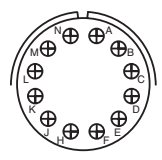

**24-19**  
A  
12  
16

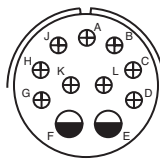

**24-20**  
D  
2 9  
12 16

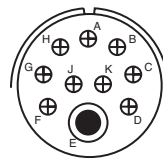

**24-21**  
D  
1 9  
8 16

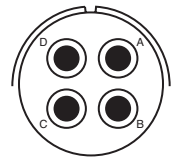

**24-22**  
D  
4  
8

Insert Arrangement  
Service Rating  
Number of Contacts  
Contact Size



CONTACT LEGEND 16 12 8 4 0

# AC Series/MS contact arrangements

front face of pin insert or rear face of socket insert illustrated

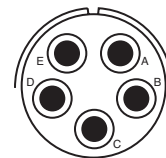
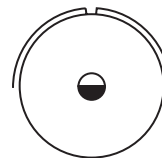
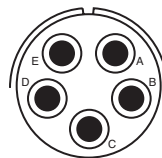
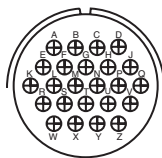
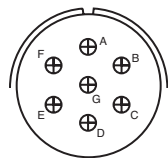

Insert Arrangement	24-27	24-28	24-51	24-52	24-53
Service Rating	E	Inst.	A	Hi-Volt	A
Number of Contacts	7	24	5*	1	5*
Contact Size	16	16	B, E for AN#10 or 12 wire A, C, D for AN #8 wire		8

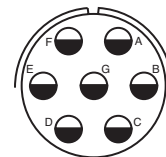
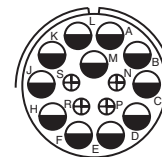
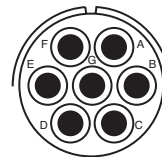
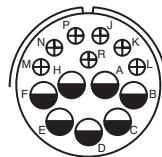
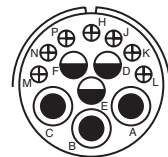

Insert Arrangement	24-58	24-59	24-60	24-65	24-66
Service Rating	A	A	A	A	D
Number of Contacts	3 3 7	7 7	7*	11 4	7
Contact Size	8 12 16	12 16	8 for #10 or 12 wire	12 16	12

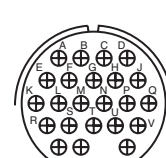
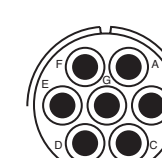
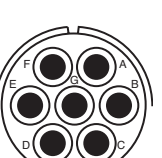
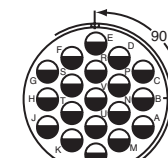

Insert Arrangement	24-67	24-71	24-75	24-79	24-80
Service Rating	Inst.	A	A	A	Inst.
Number of Contacts	19	2* 5*	5 2	5	23
Contact Size	12	8 8 for #10 or 12 wire	8 8 for #16 wire	8	16



CONTACT LEGEND 16 12 8 4 0

# AC Series/MS

## contact arrangements

front face of pin insert or rear face of socket insert illustrated

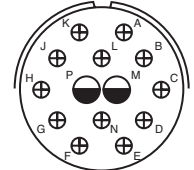
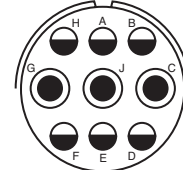
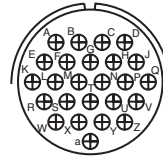
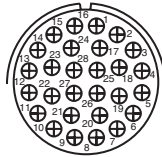
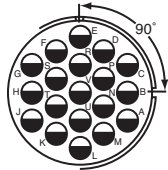

Insert Arrangement  
Service Rating  
Number of Contacts  
Contact Size

**24-84**  
**A**  
**1 18**  
**12 12 (Coax)**  
**RG-188/U**  
**or RG-174/U**

**24-96**  
**28**  
**16**

**24-AJ**  
**Inst.**  
**25**  
**16**

**28-1**  
**A A, J, E = D; Bal. = A**  
**3 6**  
**8 12**

**28-2**  
**D**  
**2 12**  
**12 16**

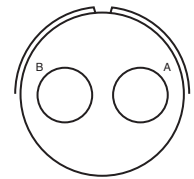
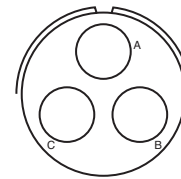
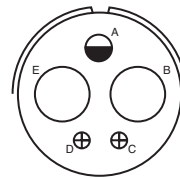
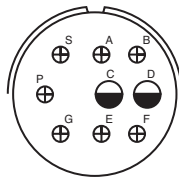
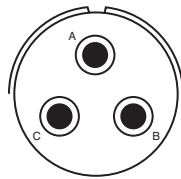

Insert Arrangement  
Service Rating  
Number of Contacts  
Contact Size

**28-3**  
**E**  
**3**  
**8**

**28-4**  
**G, P, S = E; Bal. = D**  
**2 7**  
**12 16**

**28-5**  
**D**  
**2 1 2**  
**4 12 16**

**28-6**  
**D**  
**3**  
**4**

**28-7**  
**D**  
**2**  
**4**

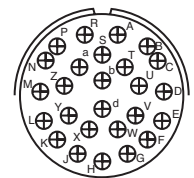
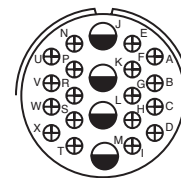
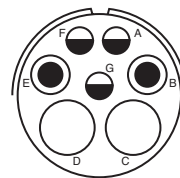
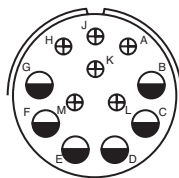
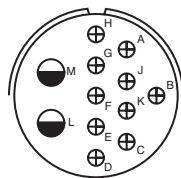

Insert Arrangement  
Service Rating  
Number of Contacts  
Contact Size

**28-8**  
**L, M = E; B = D; Bal. = A**  
**2 10**  
**12 16**

**28-9**  
**D**  
**6 6**  
**12 16**

**28-10**  
**G = D; Bal. = A**  
**2 2 3**  
**4 8 12**

**28-11**  
**A**  
**4 18**  
**12 16**

**28-12**  
**A**  
**26**  
**16**



CONTACT LEGEND 16 12 8 4 0



# AC Series/MS contact arrangements

front face of pin insert or rear face of socket insert illustrated

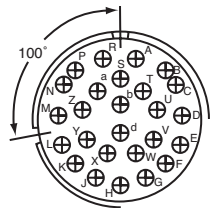

100° Rotation of 28-12

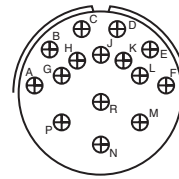
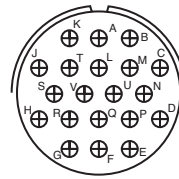
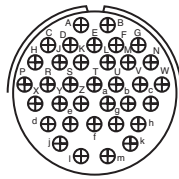

Insert Arrangement	28-13	28-15	28-16	28-17
Service Rating	A	A	A	R = B; M, N, P = D; A to L = A
Number of Contacts	26	35	20	15
Contact Size	16	16	16	16

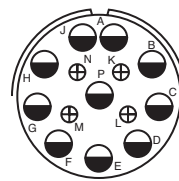
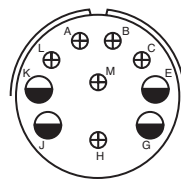
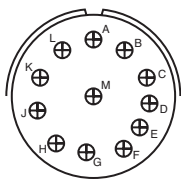

Insert Arrangement	28-18	28-19	28-20
Service Rating	M = C; G, H, J, K, L = D; A, B = A; Bal = Inst.	H, M = B; A, B = D; Bal = A	A
Number of Contacts	12	4 6	10 4
Contact Size	16	12 16	12 16

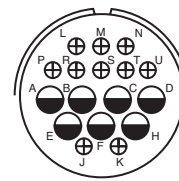
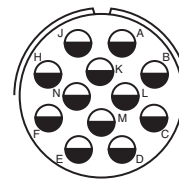
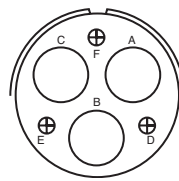
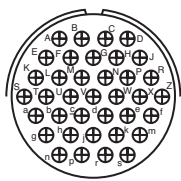

Insert Arrangement	28-21	28-22	28-51	28-59
Service Rating	A	D	A	A
Number of Contacts	37	3 3	12	7 10
Contact Size	16	4 16	12	12 16

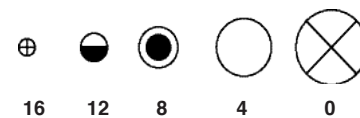

# AC Series/MS

## contact arrangements

front face of pin insert or rear face of socket insert illustrated

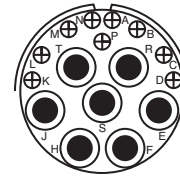
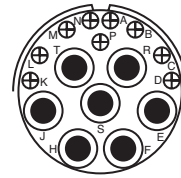
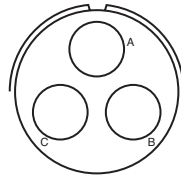
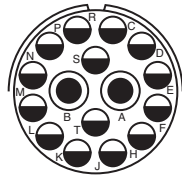

Insert Arrangement	28-66	28-72	28-74	28-75
Service Rating	A	-	A	A
Number of Contacts	2 14	3	9* 4* 3*	9* 7*
Contact Size	8 12	4 (Coax) RG-59 A/U	16 8 8 for #10 wire	16 8 for #10 wire

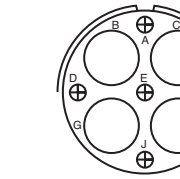
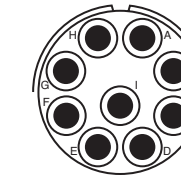
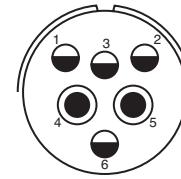

Insert Arrangement	28-79	28-82	28-84	28-AY
Service Rating	A	D	A	A
Number of Contacts	9 7	2 4	9	4 5
Contact Size	16 8	8 12	8	4 16

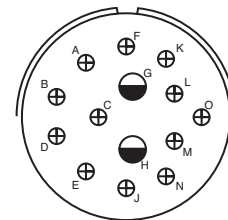
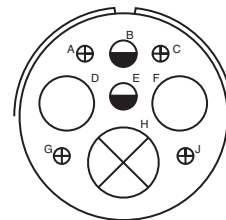
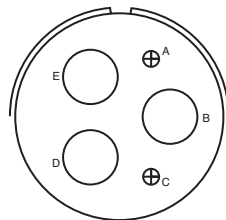
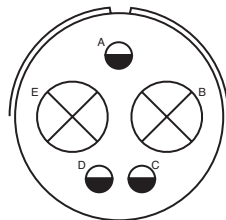

Insert Arrangement	32-1	32-2	32-3	32-4
Service Rating	A = E; B, C, D, E = D	E	D	F, J, K, N = A; Bal. =
Number of Contacts	2 3	3 2	1 2 2 4	2 12

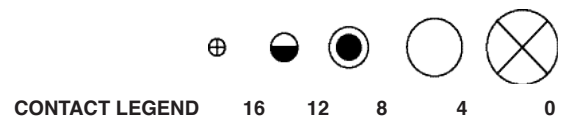

# AC Series/MS contact arrangements

front face of pin insert or rear face of socket insert illustrated

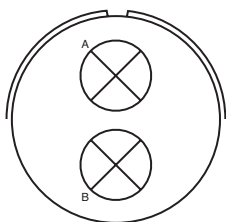

32-5

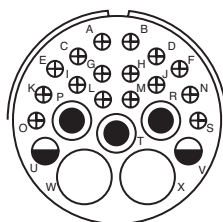

32-6

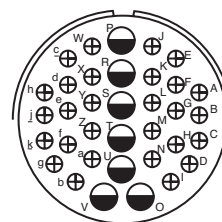

32-7

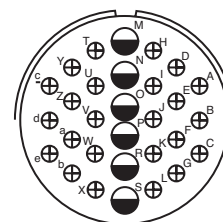

32-8

Insert Arrangement  
Service Rating  
Number of Contacts  
Contact Size

D

A

A, B, h, j = Inst.; Bal = A

A

2 3 2 16

7 28

6 24

4 8 12 16

12 16

12 16

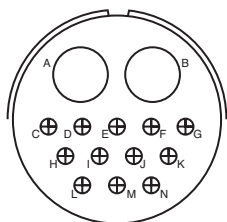

32-9

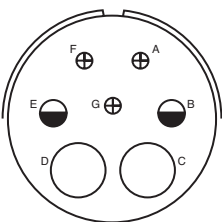

32-10

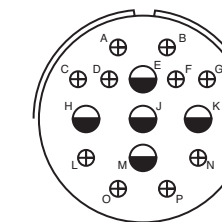

32-12

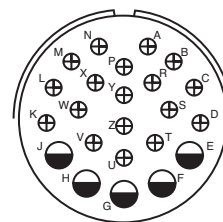

32-13

Insert Arrangement  
Service Rating  
Number of Contacts  
Contact Size

D

A, F = E; G = B; B, E = D; C, D = A

C, D, E, F, G = A; Bal. = D

D

2 12

2 2 3

5 10

5 18

4 16

4 8 16

12 16

12 16

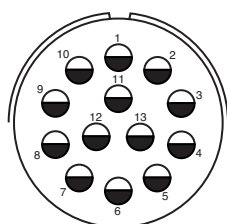

32-14

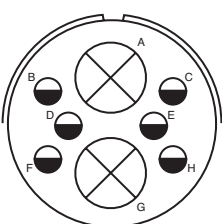

32-15

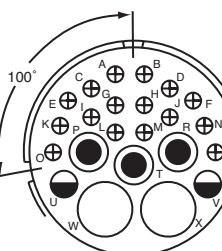

100° Rotation  
of 32-6

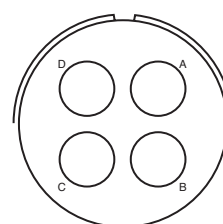

32-17

Insert Arrangement  
Service Rating  
Number of Contacts  
Contact Size

D

D

A

D

2 6

2 3 2 16

4

0 12

4 8 12 16

4



CONTACT LEGEND

16

12

8

4

0

# AC Series/MS contact arrangements

front face of pin insert or rear face of socket insert illustrated

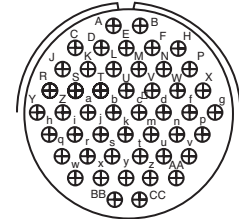
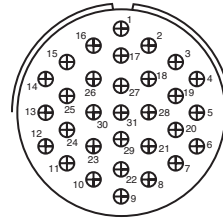
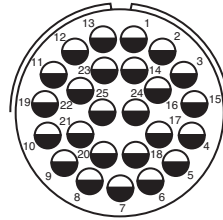
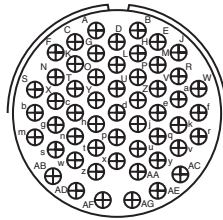

Insert Arrangement  
Service Rating  
Number of Contacts  
Contact Size

**32-22**  
**A**  
**54**  
**16**

**32-25**  
**A**  
**25**  
**12**

**32-31**  
**A**  
**31**  
**16**

**32-48**  
**Inst.**  
**48**  
**16**

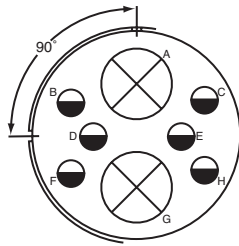

100° Rotation

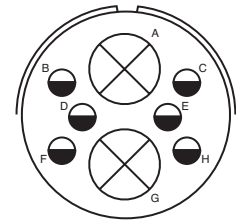
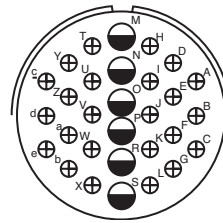
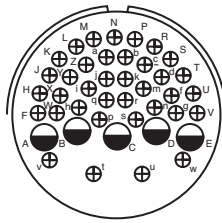

Insert Arrangement  
Service Rating  
Number of Contacts  
Contact Size

**32-52**  
**D**  
**2 6**  
**0 12**

**32-53**  
**t, u = E; Bal = Inst.**  
**5 37**  
**12 16**

**32-56**  
**A**  
**24 6**  
**16 12 for #10 wire**

**32-57**  
**\*\***  
**6 2**  
**12 0 (Coax) RG-71/U**

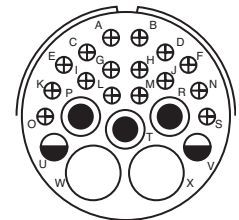
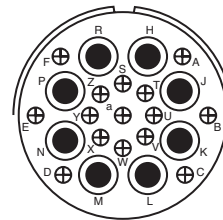
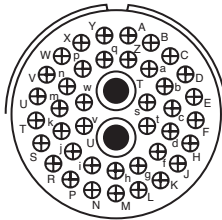
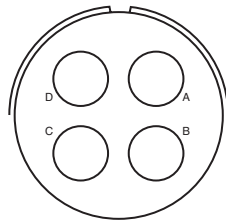

Insert Arrangement  
Service Rating  
Number of Contacts  
Contact Size

**32-58**  
**-**  
**4**  
**4 (Coax) RG-161/U or RG-179/U**

**32-59**  
**A**  
**40 2**  
**16 8 (Coax) RG-161/U**

**32-60**  
**A**  
**15 8**  
**16 8 (Coax) RG-124/U**

**32-62**  
**\*\***  
**2 1 2 16 2**  
**4 8 12 16 8 (Coax) RG-124/U16**



CONTACT LEGEND 16 12 8 4 0

# AC Series/MS

## contact arrangements

front face of pin insert or rear face of socket insert illustrated

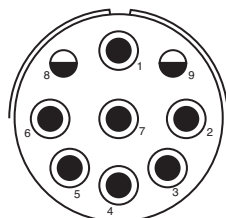
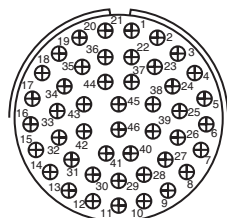
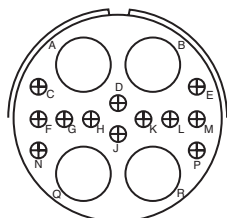
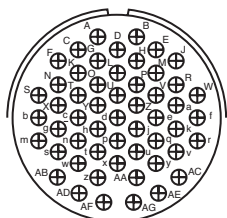

Insert Arrangement	32-64	32-68	32-73	32-75
Service Rating	Inst.	A	A	8, 9 = D
Number of Contacts	54	12 4	46	2 7
Contact Size	16	16 4 (Coax) RG-58 C/U	16	12 8 (Coax) RG-180 B/U

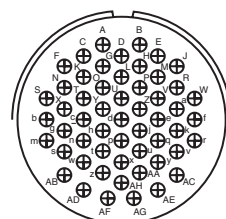
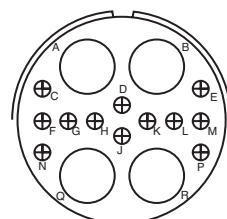
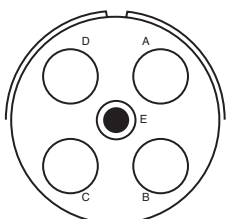
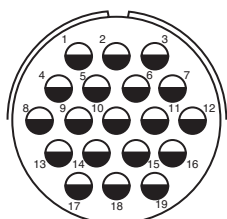

Insert Arrangement	32-76	32-79	32-82	32-AF
Service Rating	A	D	A	A
Number of Contacts	19	4 1	12 4	55
Contact Size	12	4 8	16 4	16

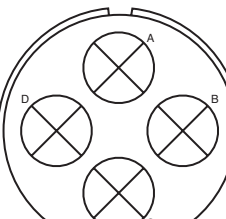
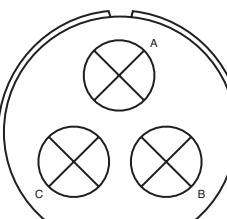
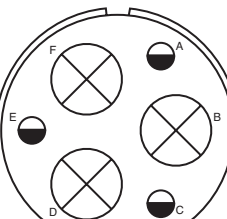
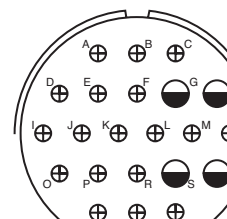

Insert Arrangement	36-1	36-3	36-4	36-5
Service Rating	D	D	A = D; B, C = A	A
Number of Contacts	4 18	3 3	3	4
Contact Size	12 16	0 12	0	0



CONTACT LEGEND 16 12 8 4 0

# AC Series/MS contact arrangements

front face of pin insert or rear face of socket insert illustrated

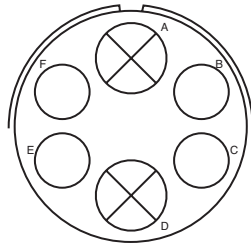

Insert Arrangement	36-6
Service Rating	A
Number of Contacts	2 4
Contact Size	0 4

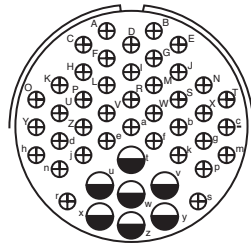

Insert Arrangement	36-7
Service Rating	A
Number of Contacts	7 40
Contact Size	12 16

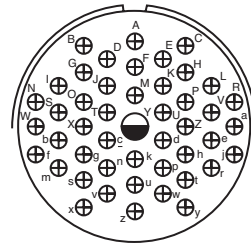

Insert Arrangement	36-8
Service Rating	A
Number of Contacts	1 46
Contact Size	12 16

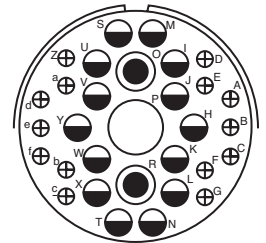

Insert Arrangement	36-9
Service Rating	A
Number of Contacts	1 2 14 14
Contact Size	4 8 12 16

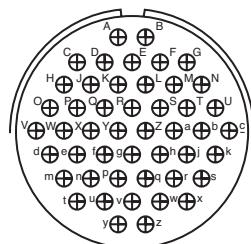

Insert Arrangement	36-10
Service Rating	A
Number of Contacts	48
Contact Size	16

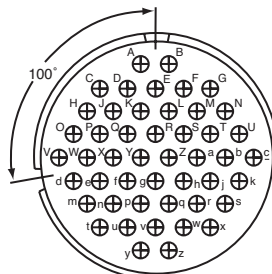

Insert Arrangement	36-11
Service Rating	A
Number of Contacts	48
Contact Size	16

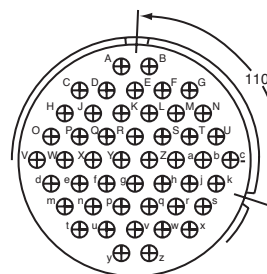

Insert Arrangement	36-12
Service Rating	A
Number of Contacts	48
Contact Size	16

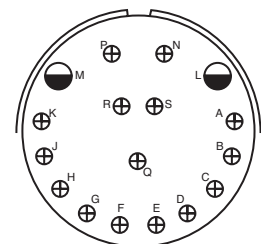

Insert Arrangement	36-13
Service Rating	N, P, Q = E; Bal. = A
Number of Contacts	2 15
Contact Size	12 16

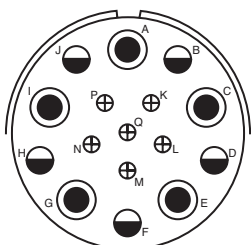

Insert Arrangement	36-14
Service Rating	D
Number of Contacts	5 5 6

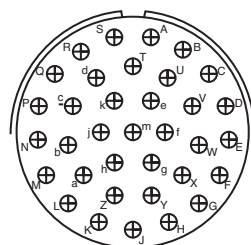

Insert Arrangement	36-15
Number of Contacts	35

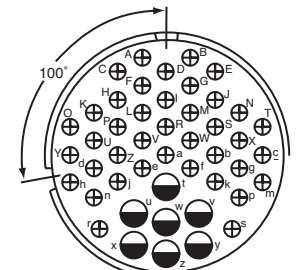

Insert Arrangement	36-16
Service Rating	M = D; Bal. = A
Number of Contacts	7 40



CONTACT LEGEND 16 12 8 4 0

# AC Series/MS contact arrangements

front face of pin insert or rear face of socket insert illustrated

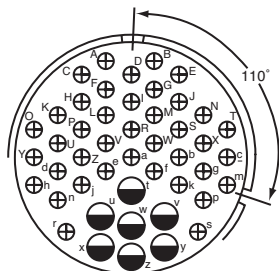

110° Rotation  
of 36-7

Insert Arrangement	36-17
Service Rating	A
Number of Contacts	7 40
Contact Size	12 16

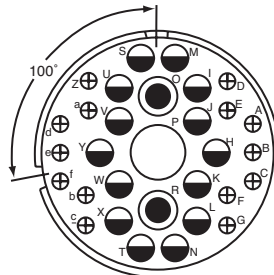

100° Rotation  
of 36-9

Insert Arrangement	36-18
Service Rating	A
Number of Contacts	1 2 14 14
Contact Size	4 8 12 16

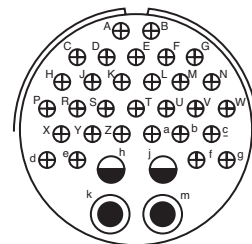

Insert Arrangement	36-20
Service Rating	A
Number of Contacts	2 2 30
Contact Size	8 12 16

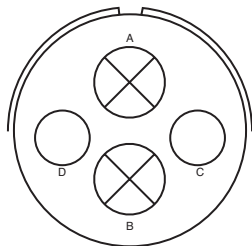

36-51

Insert Arrangement	36-51
Service Rating	D
Number of Contacts	2 2
Contact Size	0 4

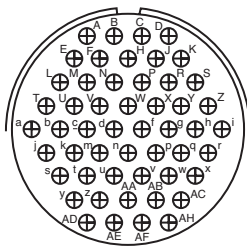

36-52

Service Rating	A
Number of Contacts	52
Contact Size	16

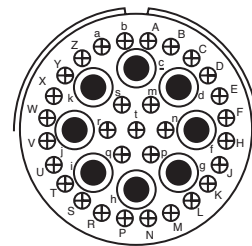

36-54

Service Rating	A
Number of Contacts	8 31
Contact Size	8 16

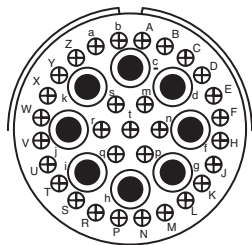

36-55

Insert Arrangement	36-55
Service Rating	A
Number of Contacts	31 8
Contact Size	16 8 for #6 wire

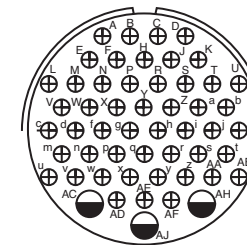

36-59

Service Rating	A
Number of Contacts	50 3
Contact Size	16 12 for #10 wire

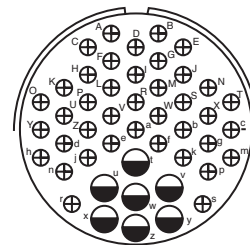

36-60

Service Rating	**
Number of Contacts	40 7
Contact Size	16 12 for #10 wire



CONTACT LEGEND

16 12 8 4 0

# AC Series/MS contact arrangements

front face of pin insert or rear face of socket insert illustrated

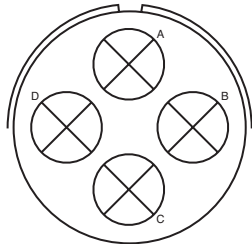

**36-64**

**Insert Arrangement**  
**Service Rating**  
**Number of Contacts**  
**Contact Size**

—  
4  
0 (Coax) RG-11/U,  
RG-12/U or RG-13/U

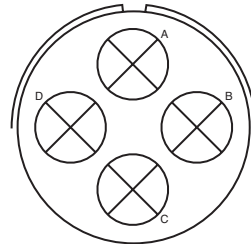

**36-65**

—  
4  
0 (Coax) RG-59/U, RG-62/U  
or RG-71/U

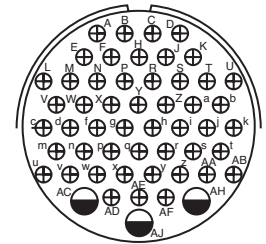

**36-71**

A  
3 50  
12 16

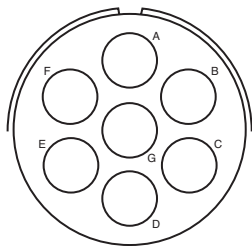

**36-73**

**Insert Arrangement**  
**Service Rating**  
**Number of Contacts**  
**Contact Size**

—  
7  
4 (Coax) RG-62B/U

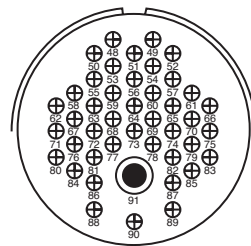

**36-74**

A  
43 1  
16 8 (Coax) RG-187/U

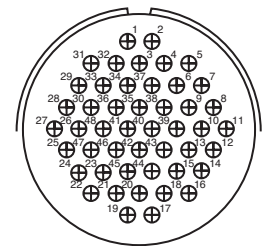

**36-75**

A  
48  
16 for #14 wire

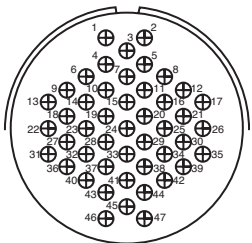

**36-76**

**Insert Arrangement**  
**Service Rating**  
**Number of Contacts**  
**Contact Size**

A  
47  
16

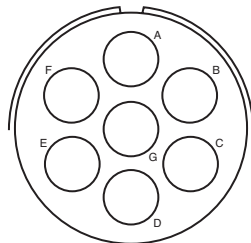

**36-77**

D  
7  
4

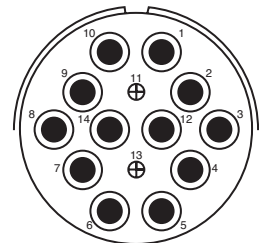

**36-78**

A  
2 12  
16 8



**CONTACT LEGEND** 16 12 8 4 0



# AC Series/MS

## contact arrangements

front face of pin insert or rear face of socket insert illustrated

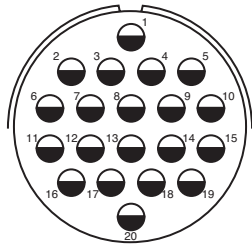

**36-79**

**Insert Arrangement**  
**Service Rating**  
**Number of Contacts**  
**Contact Size**

**A**  
**20**  
**12**

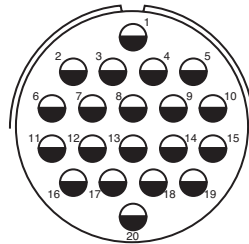

**36-80**

**Service Rating**  
**Number of Contacts**  
**Contact Size**

**A**  
**20**  
**12 for #10 wire**

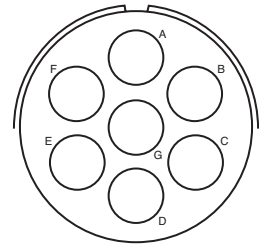

**36-83**

**Service Rating**  
**Number of Contacts**  
**Contact Size**

**-**  
**7**  
**4 (Coax) RG-58/U**

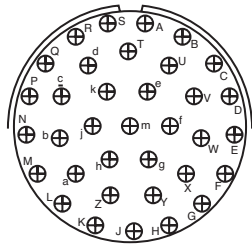

**36-85**

**Insert Arrangement**  
**Service Rating**  
**Number of Contacts**  
**Contact Size**

**M = D; Bal. = A**  
**35**  
**16 for #12 wire**

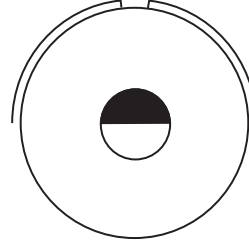

**36-97**

**Service Rating**  
**Number of Contacts**  
**Contact Size**

**C**  
**1**  
**4/0**

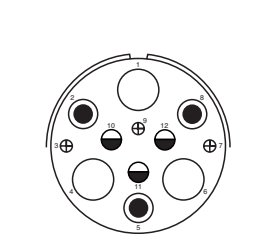

**36-99**

**Service Rating**  
**Number of Contacts**  
**Contact Size**

**D**  
**3 3 3 3**  
**4 8 12 16**

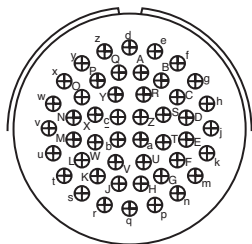

**36-AF**

**Insert Arrangement**  
**Service Rating**  
**Number of Contacts**  
**Contact Size**

**A**  
**48**  
**16**

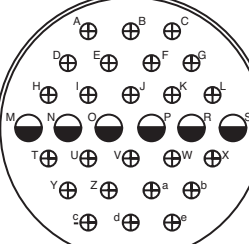

**40-1**

**Service Rating**  
**Number of Contacts**  
**Contact Size**

**D**  
**6 24**  
**12 16**

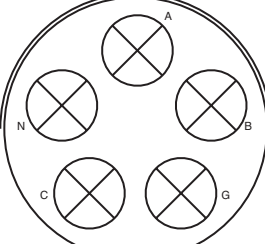

**40-5**

**Service Rating**  
**Number of Contacts**  
**Contact Size**

**A**  
**5**  
**0**



**CONTACT LEGEND**    16    12    8    4    0    2/0    4/0

# AC Series/MS contact arrangements

front face of pin insert or rear face of socket insert illustrated

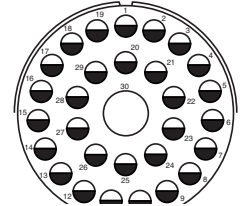
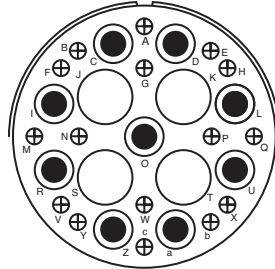
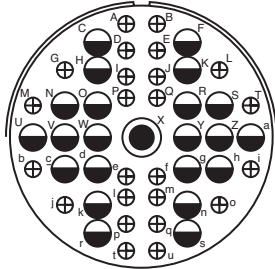

<b>Insert Arrangement</b>	<b>40-9</b>
<b>Service Rating</b>	<b>A</b>
<b>Number of Contacts</b>	<b>1 22 24</b>
<b>Contact Size</b>	<b>8 12 16</b>

<b>40-10</b>
<b>A</b>
<b>4 9 16</b>
<b>4 8 16</b>

<b>40-30</b>
<b>A</b>
<b>29 1</b>
<b>12 4</b>

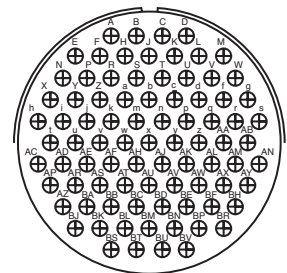
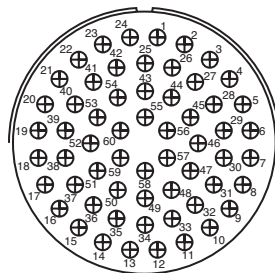
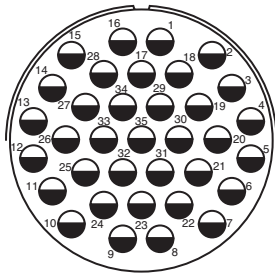

<b>Insert Arrangement</b>	<b>40-35</b>
<b>Service Rating</b>	<b>D</b>
<b>Number of Contacts</b>	<b>35</b>
<b>Contact Size</b>	<b>12</b>

<b>40-53</b>
<b>A</b>
<b>60</b>
<b>16</b>

<b>40-56</b>
<b>A</b>
<b>85</b>
<b>16</b>

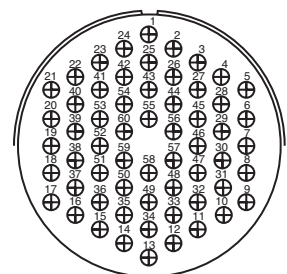
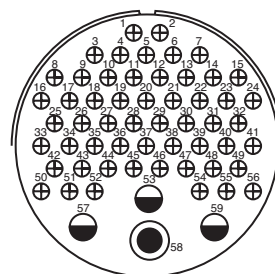
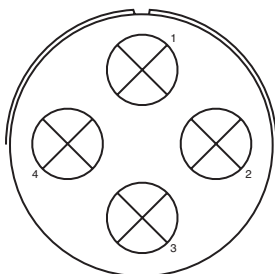

<b>Insert Arrangement</b>	<b>40-57</b>
<b>Service Rating</b>	<b>E</b>
<b>Number of Contacts</b>	<b>4</b>
<b>Contact Size</b>	<b>0</b>

<b>40-61</b>
<b>A</b>
<b>1 3 55</b>
<b>8 12 16</b>

<b>40-62</b>
<b>A</b>
<b>60</b>
<b>16</b>



CONTACT LEGEND 16 12 8 4 0

# AC Series/MS contact arrangements

front face of pin insert or rear face of socket insert illustrated

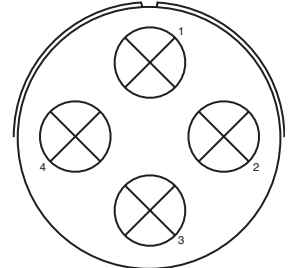
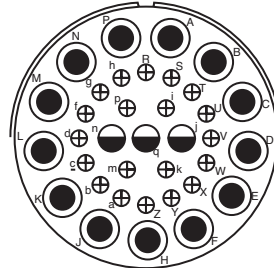
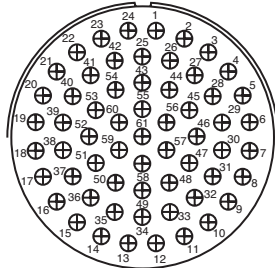

Insert Arrangement  
Service Rating  
Number of Contacts  
Contact Size

**40-63**  
**A**  
**61**  
**16 for #14 wire**

**40-64**  
-  
**3 20 13**  
**12 16 8 (Coax) RG-124/U**

**40-66**  
-  
**4**  
**0 (Coax) RG-63B/U**

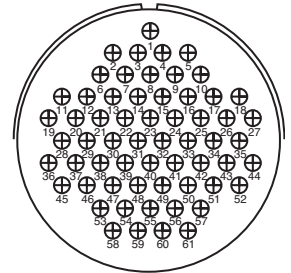
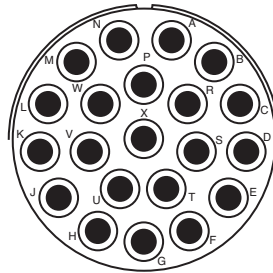
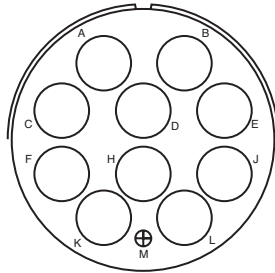

Insert Arrangement  
Service Rating  
Number of Contacts  
Contact Size

**40-67**  
**A**  
**1 10**  
**16**

**40-68**  
**A**  
**21**  
**4 (Coax) RG-59/U**

**40-70**  
**A**  
**61**  
**8 16**

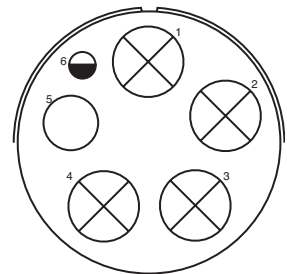
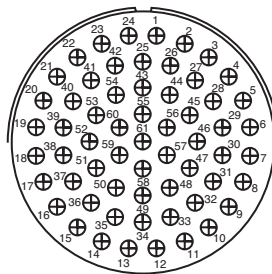
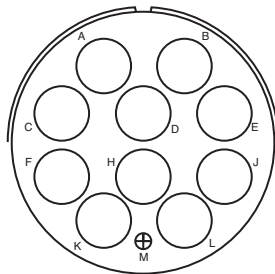

Insert Arrangement  
Service Rating  
Number of Contacts  
Contact Size  
RG-9B/U

**40-72**  
**A**  
**1 10**  
**16**

**40-73**  
**A**  
**61**  
**4 (Coax) RG-9B/U**

**40-74**  
**A**  
**1 1**  
**16 12**  
**4 (Coax) RG-62/U**  
**0 (Coax)**



CONTACT LEGEND 16 12 8 4 0

# AC Series/MS

## contact arrangements

front face of pin insert or rear face of socket insert illustrated

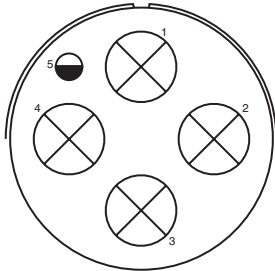

**Insert Arrangement** 40-75  
**Service Rating** E  
**Number of Contacts** 1 4  
**Contact Size** 12 0

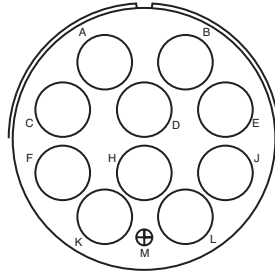

**Insert Arrangement** 40-80  
**Service Rating** A  
**Number of Contacts** 1 10  
**Contact Size** 16 4

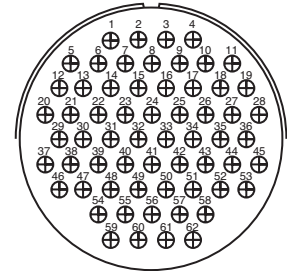

**Insert Arrangement** 40-81  
**Service Rating** A  
**Number of Contacts** 62  
**Contact Size** 16 for #14 wire

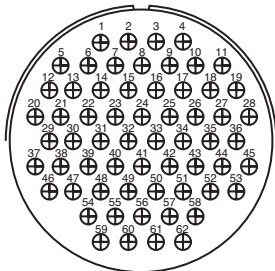

**Insert Arrangement** 40-82  
**Service Rating** A  
**Number of Contacts** 62  
**Contact Size** 16

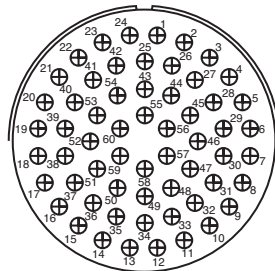

**Insert Arrangement** 40-85  
**Service Rating** A  
**Number of Contacts** 60  
**Contact Size** 16 for #14 wire

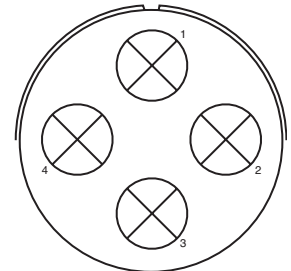

**Insert Arrangement** 40-86  
**Service Rating** -  
**Number of Contacts** 4  
**Contact Size** 0 (Coax) RG-115A/U

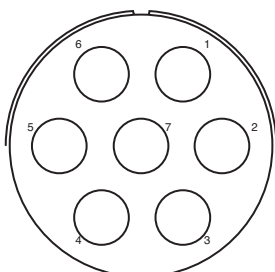

**Insert Arrangement** 40-87  
**Service Rating** D  
**Number of Contacts** 7  
**Contact Size** 4

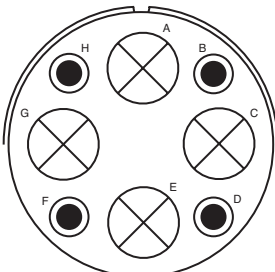

**Insert Arrangement** 40-AD  
**Service Rating** A  
**Number of Contacts** 4 4  
**Contact Size** 8 0

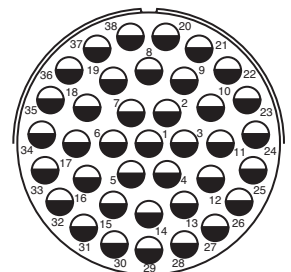

**Insert Arrangement** 40-AG  
**Service Rating** A  
**Number of Contacts** 38  
**Contact Size** 12



**CONTACT LEGEND** 16 12 8 4 0

# AC Series/MS

## contact arrangements

front face of pin insert or rear face of socket insert illustrated

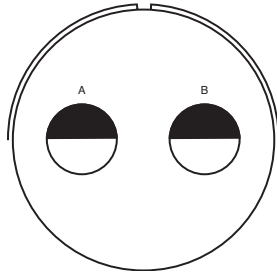

Insert Arrangement	<b>40-AP</b>
Service Rating	<b>E</b>
Number of Contacts	<b>2</b>
Contact Size	<b>4/0</b>

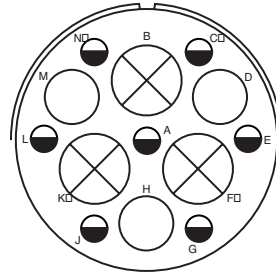

Insert Arrangement	<b>40-AR</b>
Service Rating	<b>Inst.</b>
Number of Contacts	<b>7 3 3</b>
Contact Size	<b>12 4 0</b>

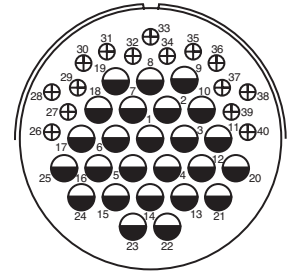

Insert Arrangement	<b>40-AS</b>
Service Rating	<b>A</b>
Number of Contacts	<b>15 25</b>
Contact Size	<b>16 12</b>

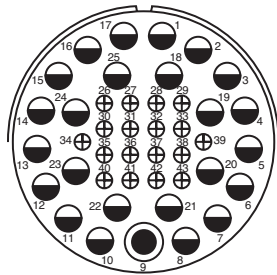

Insert Arrangement	<b>40-AT</b>
Service Rating	<b>A</b>
Number of Contacts	<b>24 18 1</b>
Contact Size	<b>12 16 8</b>

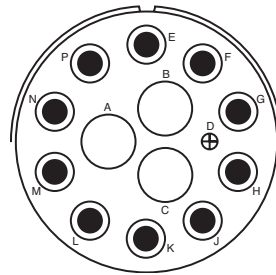

Insert Arrangement	<b>40-AU</b>
Service Rating	<b>A</b>
Number of Contacts	<b>3 10 1</b>
Contact Size	<b>4 8 16</b>

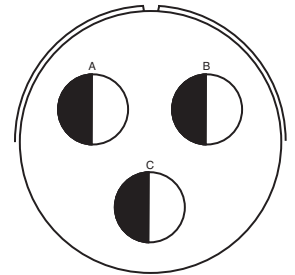

Insert Arrangement	<b>40-AV</b>
Service Rating	<b>D</b>
Number of Contacts	<b>3</b>
Contact Size	<b>2/0</b>

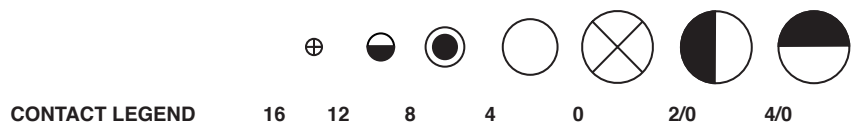

# AC Series - Thermocouple contact availability

A complete line of cylindrical connectors containing thermocouple insert arrangements is available. The contact layout for a particular arrangement will be found in either the MS/Standard contact arrangement section, pages 32-53, or the Special contact arrangement section, pages 54-58. All thermocouple contact layouts may contain either iron, alumel, chromel, constantan, standard (copper) or brass (dummy) contacts. See the thermocouple tabulations on the following pages.

The following abbreviations are used in the contact material column in the charts that follow. Also, thermocouple contacts are color coded as shown. (This identification is made by means of small dots of stain on the solder well end of the contact).

Abbreviation	Material	Color Code
Ir.	Iron	Black
Con.	Constantan	Yellow
Cu.	Copper Alloy	N/A
Ch.	Chromel	White
Al.	Alumel	Green
Dummy	Brass	N/A

## WIRE WELL DATA

Contact Size	Well Inside Dia. +.004 -.002	Well Depth +.031 -.000	Solder Well Barrel Outside Dia.
12	.125	.250	.166 ±.003
16	.094	.188	.125 <sup>+.002</sup> -.004

## RECOMMENDED WIRE

I Chromel - Alumel	Use wire in accordance with MIL-W-5848
II Iron - Constantan	Use wire in accordance with MIL-W-5845

# AC Series - Thermocouple contact arrangements

Shell Size and Arrg.	Similar to MS Arrg.	Total Contacts	Contact Size		Pin Insert Rotation C W	Contact Material
			12	16		
10SL-51	10SL-4	2		2	45°	A = Ir.; B = Con.
10SL-52	10SL-4	2		2	45°	A = Cu.; B = Con.
10SL-53	10SL-4	2		2	45°	A = Al.; B = Ch.
10SL-54	10SL-3	3		3	None	A = Ir.; B = Con.; C = Cu.
10SL-55	10SL-3	3		3	None	A = Al.; B = Ch.; C = Cu.
10SL-56	10SL-4	2		2	None	A = Al.; B = Ch.
10SL-57	10SL-4	2		2	None	A = Ch.; B = Con.
10SL-58	10SL-3	3		3	None	A = Ch.; B = Al.; C = Cu.
10SL-59	10SL-4	2		2	None	A = Ch.; B = Al.
10SL-60	10SL-4	2		2	None	A = Ir.; B = Con.
10SL-61	10SL-4	2		2	None	A = Cu.; B = Con.
10SL-62	10SL-3	3		3	None	A = Cu.; B = Al.; C = Ir.
10SL-63	10SL-3	3		3	None	A, C = Con.; B = Ch.
10SL-64	10SL-3	3		3	None	A, C = Ch.; B = Al.
12S-51	12S-3	2		2	315°	A = Ch.; B = Al.
12S-54	12S-3	2		2	315°	A = Ir.; B = Con.
12S-55	12S-3	2		2	45°	A = Cu.; B = Con.
12S-56	12S-3	2		2	None	A = Al.; B = Ch.
12S-57	12S-3	2		2	60°	A = Ch.; B = Al.
12S-58	12S-3	2		2	120°	A = Ir.; B = Con.
12S-59	12S-3	2		2	None	A = Ir.; B = Con.
12S-60	12S-3	2		2	None	A = Cu.; B = Con.
12S-61	12S-3	2		2	None	A = Ch.; B = Con.
12S-62	12S-3	2		2	None	A = Ch.; B = Al.
14S-51	14S-9	2		2	90°	A = Al.; B = Ch.
14S-52	14S-2	4		4	45°	A, B = Cu.; C = Al.; D = Ch.
14S-53	14S-9	2		2	90°	A = Ir.; B = Con.
14S-54	14S-6	6		6	45°	A, C, E = Ir.; B, D, F = Con.
14S-55	14S-2	4		4	45°	A, C = Ir.; B, D = Con.
14S-56	14S-2	4		4	45°	A = Ir.; B = Con.; C, D = Cu.
14S-57	14S-2	4		4	45°	A, C = Al.; B, D = Ch.
14S-58	14S-7	3		3	45°	A = Al.; B = Ch.; C = Cu.
14S-59	14S-9	2		2	90°	A = Cu.; B = Con.
14S-60	14S-9	2		2	None	A = Al.; B = Ch.
14S-61	14S-6	6		6	45°	A = Al.; B = Ch.; C = Ir.; D = Con.; E, F = Cu.
14S-63	14S-6	6		6	None	A, C = Al.; B, D = Ch.; E = Ir.; F = Con.
14S-64	14S-2	4		4	None	A, C = Con.; B, D = Cu.
14S-65	14S-6	6		6	None	A, C, E = Cu.; B, D, F = Con.
14S-67	14S-6	6		6	None	A = Al.; B = Ch.; Balance = Cu.
14S-68	14S-2	4		4	45°	A = Ch.; B = Con.; C, D = Cu.
14S-69	14S-7	3		3	None	A = Con.; B = Ch.; C = Cu.
14S-70	14S-2	4		4	None	A, D = Ch.; B, C = Al.
14S-71	14S-2	4		4	None	A, B, D = Cu.; C = Con.
14S-72	14S-9	2		2	None	A = Con.; B = Cu.
14S-73	14S-2	4		4	None	A, B = Cu.; C = Al.; D = Ch.

# AC Series - Thermocouple contact arrangements

Shell Size and Arrg.	Similar to MS Arrg.	Total Contacts	Contact Size		Pin Insert Rotation C W	Contact Material
			12	16		
14S-74	14S-2	4		4	None	A, B = Ch.; C, D = Al.
14S-75	14S-2	4		4	None	A, B = Cu.; C, D = Con.
14S-76	14S-2	4		4	None	A, C = Al.; B, D = Ch.
14S-77	14S-2	4		4	None	A, D = Al.; B, C = Ch.
14S-78	14S-9	2		2	None	A = Ch.; B = Al.
16S-52	16S-4	2		2	None	A = Ch.; B = Al.
16S-54	16S-1	7		7	None	A = Al.; B = Ch.; Balance = Cu.
16S-55	16S-1	7		7	None	A = Con.; Balance = Cu.
16-52	16-11	2	2		90°	A = Al.; B = Ch.
16-53	16-9	4	2	2	70°	A = Al.; C = Ch.; B, D = Cu.
16-55	16-10	3	3		45°	A = Al.; B = Ch.; C = Cu.
16-56	16-13	2	2		90°	A = Con.; B = Cu.
16-57	16-10	3	3		None	A = Al.; B = Cu.; C = Ch.
16-58	16-10	3	3		None	A = Con.; B, C = Cu.
16-60	16-13	2	2		None	A = Al.; B = Ch.
16-62	16-11	2	2		None	A = Con.; B = Cu.
18-51	18-12	6		6	None	A = Ir.; B, E = Con.; D = Cu.; C, F = Dummy
18-52	18-11	5	5		None	A = Ir.; B = Con.; C = Ch.; D = Al.; E = Dummy
18-53	18-12	6		6	None	A, D = Ir.; B, E = Con.; C, F = Dummy
18-54	18-15	4	4		None	A, C = Al.; B, D = Ch.
18-56	18-1	10		10	45°	A, C, E, G, I = Ir.; B, D, F, H, J = Con.
18-57	18-12	6		6	45°	A, C, E = Al.; B, D, F = Ch.
18-59	18-12	6		6	45°	A, C = Ir.; B, E, F = Con.; D = Cu.
18-60	18-11	5	5		45°	A, D = Al.; B, C, = Ch.; E = Cu.
18-61	18-12	6		6	None	A, C = Ir.; B, D = Con.; E = Ch.; F = Al.
18-62	18-12	6		6	None	A, B, C = Ir.; D, E, F = Con.
18-63	18-15	4	4		None	A, C = Con.; B, D = Cu.
18-65	18-12	6		6	None	A = Ir.; B = Con.; Balance = Cu.
18-66	18-1	10		10	None	A, C, E, G, I = Cu.; B, D, F, H, J = Con.
18-67	18-12	6		6	None	A, C, E = Cu.; B, D, F = Con.
18-68	18-11	5	5		None	A, D = Al.; B, C = Ch.; E = Cu.
18-69	18-1	10		10	None	A = Al.; B = Ch.; Balance = Cu.
18-70	18-11	5	5		None	A = Ir.; B = Con.; C = Ch.; D = Al.; E = Cu.
18-71	18-15	4	4		None	A = Con.; Balance = Cu.
18-72	18-15	4	4		None	D = Con.; Balance = Cu.
18-73	18-9	7	2	5	None	A = Al.; D = Ch.; Balance = Cu.
18-74	18-12	6		6	None	A = Ch.; B = Al.; D = Ir.; E = Cu.; C, F = Con.
20-52	20-4	4	4		315°	A = Ir.; B = Con.; C = Ch.; D = Al.
20-56	20-7	8		8	45°	A, B, G, H = Ir.; C, D, E, F = Con.
20-60	20-7	8		8	45°	D = Ch.; E = Al.; Balance = Cu.
20-61	20-29	17		17	45°	A, B, M = Cu.; Balance = Con.
20-62	20-15	7	7		80°	A, C, E = Al.; B, D, F = Ch.; G = Cu.
20-64	20-27	14		14	None	A = Al.; C = Ch.; Balance = Cu.



# AC Series - Thermocouple contact arrangements

Shell Size and Arrg.	Similar to MS Arrg.	Total Contacts	Contact Size		Pin Insert Rotation C W	Contact Material
			12	16		
20-65	20-27	14		14	None	A, B, C, D, E, F, G = Ir.; H, I, J, K, L, M, N = Con.
20-67	20-16	9	2	7	None	H = Al.; I = Ch.; Balance = Cu.
20-68	20-7	8		8	None	A, B, G, H = Con.; C, D, E, F = Cu.
20-69	20-27	14		14	None	A, B, C, D, E, F, G = Cu.; H, I, J, K, L, M, N = Con.
20-70	20-29	17		17	None	A, C, E, G, J, L, N, R, T = Ir.; B, D, F, H, K, M, P, S = Con.
20-71	20-29	17		17	None	S = Al.; R = Ch.; Balance = Cu.
20-74	20-29	17		17	None	A, C, E, G, J, L, N, R = Ir.; B, D, F, H, K, M, P, S = Con.; T = Cu.
20-75	20-15	7	7		None	G = Al.; Balance = Ch.
20-77	20-16	9	2	7	None	A = Con.; Balance = Std.
20-80	20-27	14		14	None	A, C, E, G, I, K, M = Cu.; B, D, F, H, J, L, N = Con.
20-81	20-27	14		14	None	A, C, E, G, I, K, M = Ch.; B, D, F, H, J, L, N = Al.
20-82	20-29	17		17	None	A, C, E, G, J, L, N, R = Al.; B, D, F, H, K, M, P, S = Ch.; T = Cu.
22-36	22-23	8	8		347°	A, C, E, G = Ir.; B, D, F, H = Con.
22-57	22-14	19		19	45°	A, C, E, G, J, L, N, R = Ir.; B, D, F, H, K, M, P, S = Con.; T, U, V = Cu.
22-60	22-14	19		19	45°	U = Al.; N = Ch.; Balance = Cu.
22-62	22-23	8	8		60°	A, B, F, G = Al.; C, D, E, H = Ch.
22-68	22-19	14		14	45°	A, C, E, G, J, L, M = Ir.; B, D, F, H, K, P, N = Con.
22-69	22-19	14		14	45°	A, C, E, G, J, L, M = Cu.; B, D, F, H, K, P, N = Con.
22-71	22-14	19		19	None	V = Al.; U = Ch.; Balance = Cu.
22-72	22-5	6	2	4	None	B = Al.; E = Ch.; Balance = Cu.
22-73	22-5	6	2	4	None	E = Al.; B = Ch.; Balance = Cu.
22-74	22-23	8	8		None	A, C, E, G = Ir.; B, D, F, H = Con.
22-75	22-23	8	8		None	A = Al.; B, D, G, H = Cu.; C = Ch.; E = Ir.; F = Con.
22-76		21		21	None	W = Con.; Balance = Cu.
22-77	22-19	14		14	None	B, D, F, H, J, K, M, P = Cu.; A, E, L = Ir.; C, G, N = Con.
22-78	22-14	19		19	None	A, C, E, G, H, K, M, P, R, T = Con.; Balance = Cu.
22-79	22-10	4		4	None	A, C = Con.; B, D = Cu.
24-56	24-20	11	2	9	45°	E = Al.; F = Ch.; Balance = Cu.
24-57	24-28	24		24	45°	A, C, J, V, Y, W, K, E, H, U, S, M = Ch.; Balance = Al.
24-62	24-28	24		24	None	A, C, E, G = Ir.; B, D, F, H = Con.; R, T = Ch.; S, U = Al.; Balance = Cu.
24-63	24-28	24		24	None	A, C, E, G, J, L, K, N, S, U, W, Y = Cu.; B, D, F, H, Q, R, M, P, T, V, X, Z = Con.
24-64	24-5	16		16	None	A, B, C, D, E, F, G, H = Ir.; J, K, L, M, N, P, R, S = Con.
24-68	24-28	24		24	None	D = Con.; Balance = Cu.
24-81	24-7	16	2	14	None	A, C, E, G, I, K, M, N, P = Cu.; B, D, F, H, J, L, O = Con.
28-53	28-11	22	4	18	45°	J, L = Al.; K, M = Ch.; Balance = Cu.
28-58	28-20	14	10	4	45°	A, C, E, G, K, M = Al.; B, D, F, H, L, N = Ch.; J, P = Cu.
28-61	28-21	37		37	45°	A, C, J, Z, m, r, n, a, K, F, H, X, k, h, T, M, N, d = Ir.; Balance = Con.
28-63	28-20	14	10	4	45°	A, C, E, G, J = Al.; B, D, F, H, P = Ch.; Balance = Cu.
28-64	28-15	35		35	None	A, d = Al.; B, j = Ch.; C, D, E, F, G, N, P, R, S, H, J, K, L, M, W, X, Y, Z = Con.; Balance = Cu.
28-65	28-12	26		26	None	A, C, E, G, J, L, N, R, T, V = Ir.; X, Z = Al.; B, D, F, H, K, M, P, S, U, W = Con.; Y, a = Ch.; b, d = Cu.
28-67	28-16	20		20	None	U = Con.; Balance = Cu.
28-68	28-15	35		35	45°	T = Al.; U = Ch.; Balance = Cu.

# AC Series - Thermocouple contact arrangements

Shell Size and Arrg.	Similar to MS Arrg.	Total Contacts	Contact Size		Pin Insert Rotation C W	Contact Material
			12	16		
28-69	28-11	22	4	18	None	G = Al.; R = Ch.; Balance = Cu.
28-70	28-11	22	4	18	None	A = Al.; B = Ch.; Balance = Cu.
28-77	28-11	22	4	18	None	J = Con.; Balance = Cu.
28-81	28-21	37		37	None	A, D, S, Z, n, s = Ir.; B, J, K, f, g, r = Con.; G, L, P, b, e, j = Al.; F, H, T, X, h, k = Ch.; Balance = Cu.
32-51	32-8	30	6	24	90°	M = Ch.; N = Al.; Balance = Cu.
32-55	32-8	30	6	24	125°	M, N = Ch.; O, P = Al.; Balance = Cu.
36-53	36-7	47	7	40	45°	u, v, w = Al.; x, y, z = Ch.; Balance = Cu.
36-56	36-10	48		48	None	A, C, E, G, L, J, H, P, R, T, V, X Z, b, d, f, h, k, q, n, m, u, w, y = Con.; Balance = Cu.
36-57	36-8	47	1	46	None	W = Al.; f = Ch. Balance = Cu.
36-58	36-15	35		35	None	H = Al.; G = Ch.; Balance = Cu.
36-61	36-15	35		35	None	A, C, E, J, K, L, M, N, P, R, T, V, f, X, Y, h, j, c = Con.; Balance = Cu.
36-62	36-10	48		48	None	A, C, E, = Al.; B, D, F = Ch.; Balance = Cu.
36-82	36-52*	52		52	None	v, g = Ir.; p, y, c = Con. x = Ch.; Balance = Cu.
40-58	40-56*	85		85	None	A, C, E, H, K, M, P, S, U, W, Y, a, c, f, h, j, m, p, r, t, v, x, z, AB, AD, AF, AJ, AL, AN, AP, AS, AU, AW, AY, BA, BC, BE, BH, BK, BM, BP, BS, BU = Ir.; Balance = Con.
40-59	40-56*	85		85	None	B = Ch.; C = Con.; Balance = Cu.
40-77	40-53*	60		60	None	55, 60 = Ir.; 57, 58, 59 = Con.; 56 = Ch.; Balance = Cu.
40-78	40-53*	60		60	None	50, 51 = Ir.; 27, 28, 29, 31, 32, 34, 36, 37 = Con.; 25, 39, 40, 41 = Al.; 43, 44, 45, 46, 47, 48, 49, 52, 53, 54 = Ch.; Balance = Cu.
44-57	44-52	104		104	None	A, C, E, G, J, L, etc. = Cu.; B, D, F, H, K, M, etc. = Con.

\* Amphenol arrangement

# AC Series

## how to order

To more easily illustrate ordering procedure, part number ACCL06AF18-1SX(025) is shown as follows:

AC	C	L	06	AF	18-1	S	X	(025)
1	2	3	4	5	6	7	8	9

1. **AC** designates Amphenol Industrial Series Threaded Connectors

2. **C** designates Crimp Contacts

**S** designates Solder Contacts

3. **L** designates low smoke zero halogen inserts and grommets

Omit for standard resilient inserts and grommets.

4. **Shell Style**

00 - Wall Mounting Receptacle

01 - Line Receptacle

02 - Box Mounting Receptacle

05 - Straight Plug

06 - Straight Plug with hardware

08 - 90 degree Plug

5. **Class**

A or AF - General duty connector

E or F - Environmental connector for a wire bundle

PGA or

PGR - Environmental connector for jacketed cable

6. **Shell size and insert arrangement**

See insert availability on pages 25-27

7. **Contact type**

P - Pin contacts

S - Socket contacts

R - RADSOK® crimp socket contacts (see page 31)

Ask for Brochure SL-391 for Amphe-Power Connectors with RADSOK Technology.

8. **Alternate insert rotation**

“W”, “X”, “Y”, “Z” designates that the insert is rotated in its shell from a normal position. No letter required for normal (no rotation) position.

See page 28 for availability.

9. **Variations**

(072) - Gray zinc nickel finish

(023) - Electroless nickel finish

(025) - Black zinc alloy finish

(G96) - Black hard-coat anodize

(B30) - Gold plated contacts

(116) - Non-pre-tinned solder contacts

(472) - Black zinc alloy finish and solder contacts

less pre-filled cup ✓

(548) - Electroless nickel finish and solder contacts

less pre-filled cup ✓

(724) - Gray zinc nickel finish and solder contacts

less pre-filled cup ✓

**RoHS Compliant**



For further RoHS Compliant support, contact Amphenol Industrial Operations or call 1-866-315-8559.

# MS/Standard

## how to order

### SAE AS50151 (Solder Contacts)

MS	3102	A	18-3	P	W
1	2	3	4 5	6	7

#### 1. Connector Type

MS designates Military Standard

#### 2. Connector Style

3100 wall mounting receptacle

3101 cable connecting receptacle

3102 box mounting receptacle

3106 straight plug

3108 90° plug

#### 3. Service Class

A solid shell for general, non-environmental applications

C solid shell for pressurized applications (MS3102 only)

E environmental resisting

F environmental resisting with strain relief

R lightweight environmental resisting

#### 4., 5. Shell size and insert arrangement - see tables, pages 25-27.

#### 6. Contact Types

P designates pin contact

S designates socket contact

#### 7. Insert Rotation

“W”, “X”, “Y”, or “Z” designate that insert is rotated in its shell from normal position. No letter required for normal (no rotation) position.

# AC Series/MS – accessories

## 10-40450, 10-36675 sealing gaskets, 10-405996 sealing plugs, sealing ranges

### SEALING GASKETS

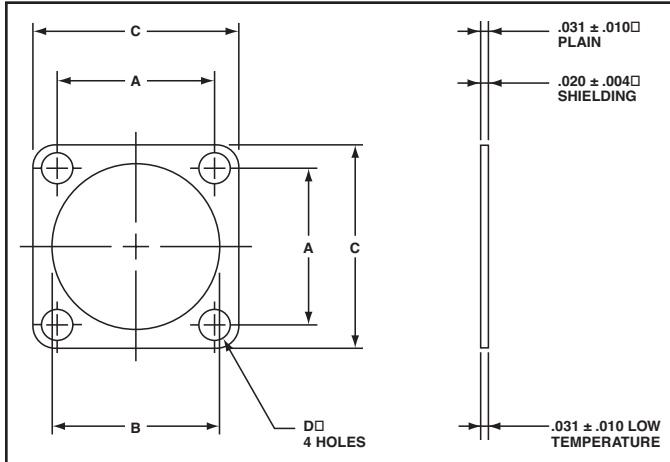

The Amphenol plain flat gasket of synthetic rubber material is provided to take complete advantage of waterproof and pressure sealing features. It is for use with the flange mounted receptacle.

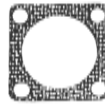

This flat gasket is provided to give the maximum in connector performance. Its special feature is in providing the maximum radio shielding under difficult conditions of high receiver sensitivity and low signal strength while retaining the sealing characteristics of the plain gasket. This gasket is for use with the flange mounting



This gasket is provided for applications where the major requirement is resistance to the injurious effects of extremely low temperature. Even at temperatures as low as  $-67^{\circ}\text{F}$  this gasket retains its resiliency and will seal a pressure differential of 30 psi.

MS Shell Size	Installation Dimensions								Order Data		
	Inches				Millimeters				Plain	Shielding	Low Temperature Style
	A $\pm .010$	B $+.016$ $-.000$	C $+.016$ $-.000$	D $\pm .010$	A $\pm .25$	B $+.41$ $-.00$	C $+.41$ $-.00$	D $\pm .25$			
8S	.594	.500	.875	.172	15.09	12.70	22.22	4.37	10-40450-8	10-40450-8S	10-36675-8
10S	.719	.625	1.000	.172	18.26	15.88	25.40	4.37	10-40450-10	10-40450-10S	10-36675-10
10SL	.719	.625	1.000	.172	18.26	15.88	25.40	4.37	10-40450-10	10-40450-10S	10-36675-10
12S	.813	.750	1.094	.172	20.65	19.05	27.79	4.37	10-40450-12	10-40450-12S	10-36675-12
12	.813	.750	1.094	.172	20.65	19.05	27.79	4.37	10-40450-12	10-40450-12S	10-36675-12
14S	.906	.875	1.188	.172	23.01	22.22	30.18	4.37	10-40450-14	10-40450-14S	10-36675-14
14	.906	.875	1.188	.172	23.01	22.22	30.18	4.37	10-40450-14	10-40450-14S	10-36675-14
16S	.969	1.000	1.281	.172	24.61	25.40	32.54	4.37	10-40450-16	10-40450-16S	10-36675-16
16	.969	1.000	1.281	.172	24.61	25.40	32.54	4.37	10-40450-16	10-40450-16S	10-36675-16
18	1.063	1.125	1.375	.203	27.00	28.57	34.92	5.16	10-40450-18	10-40450-18S	10-36675-18
20	1.156	1.250	1.500	.203	29.36	31.75	38.10	5.16	10-40450-20	10-40450-20S	10-36675-20
22	1.250	1.375	1.625	.203	31.75	34.92	41.27	5.16	10-40450-22	10-40450-22S	10-36675-22
24	1.375	1.500	1.750	.203	34.92	38.10	44.45	5.16	10-40450-24	10-40450-24S	10-36675-24
28	1.563	1.750	2.000	.203	39.70	44.45	50.80	5.16	10-40450-28	10-40450-28S	10-36675-28
32	1.750	2.000	2.250	.219	44.45	50.80	57.15	5.56	10-40450-32	10-40450-32S	10-36675-32
36	1.938	2.188	2.500	.219	49.23	55.58	63.50	5.56	10-40450-36	10-40450-36S	10-36675-36
40	2.188	2.438	2.750	.219	55.58	61.93	69.85	5.56	10-40450-40	10-40450-40S	10-36675-40

### SEALING PLUG 10-405996-XX1

Sealing plugs are used to fill unused holes in multi-holed grommet configurations.

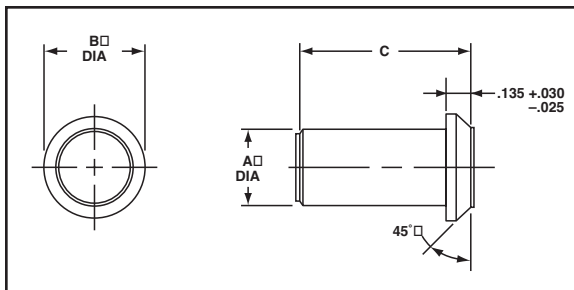

All dimensions for reference only.

Order No.	Contact Size	Wire Size	Color Code	Inches			Millimeters		
				A Dia $\pm .010$	B $\pm .005$	C $\pm .010$	A Dia. $\pm 0.2$	B $\pm 0.1$	C $\pm 0.2$
10-405996-161	16	20-16	Blue	.083	.133	.564**	2.1	3.4	14.3***
10-405996-121	12	14-12	Yellow	.121	.171	.564**	3.1	4.3	14.3***
10-405996-081	8	10-8	White	.185	.315	.470	4.7	8.0	11.9
10-405996-041	4	4-6	Blue	.310	.415	.470	7.9	10.5	11.9
10-405996-001	0	0-2	Yellow	.440	.605	1.000	11.2	15.4	25.4

\*\*  $\pm .020$   
\*\*\*  $\pm 0.5$  mm

### GROMMET HOLE SEALING RANGE

Hole Size	Sealing Range	
	Millimeters	Inches
16	2.3 – 3.0	.090 – .118
12	3.2 – 4.5	.126 – .177
8	3.8 – 6.5	.150 – .256
4	7.1 – 9.3	.279 – .366
0	10.0 – 13.7	.394 – .539

# AC Series/MS Accessories

## MS3057-A style cable clamp, MS3420 sleeve

The MS3057-A style cable clamp was designed for use with jacketed cable or wires protected by tubing. Both clamping halves float for maximum strain relief. For unjacketed cable or wires, use corresponding MS3420 sleeve. To order clamp with sleeve, add -1 to the 97 - number. Two telescoping sleeves are furnished with shells sizes 24 and larger.

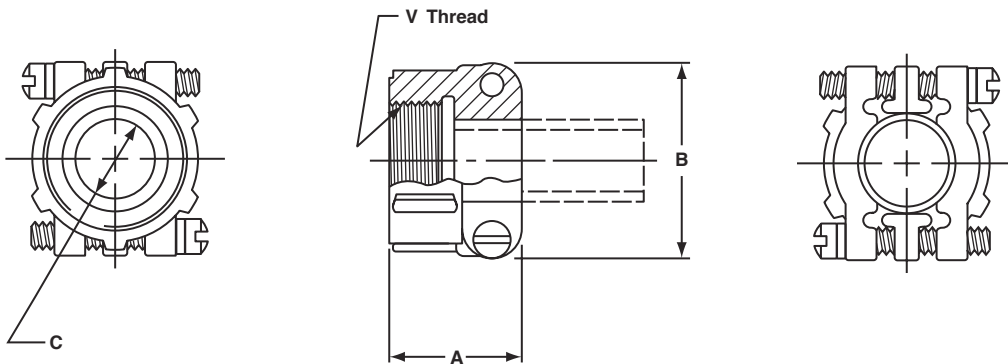

Shell Size	Amphenol Number	A ±.031	B Max.	C Dia. Min.	V Thread
10SL, 12S	97-3057-1004	.795	.842	.3125	.6250-24
14, 14S	97-3057-1007	.850	.995	.4375	.7500-20
16, 16S	97-3057-1008	.920	1.120	.5625	.8750-20
18	97-3057-1010	.920	1.216	.6250	1.0000-20
20, 22	97-3057-1012	.927	1.403	.7500	1.1875-18
24, 28	97-3057-1016	1.015	1.683	.9375	1.4375-18
32	97-3057-1020	1.095	2.050	1.2500	1.7500-18
36	97-3057-1024	1.156	2.245	1.3750	2.0000-18

Sleeve MS Part No.	Amphenol Number	A ±.005	B ±.005	C ±.010	D ±.031
3420-3	9779-513-3	.130	.210	.374	2.875
3420-4	9779-513-4	.220	.302	.500	2.750
3420-6	9779-513-6	.312	.427	.614	2.625
3420-8	9779-513-8	.437	.552	.739	2.500
3420-10	9779-513-10	.562	.615	.889	2.375
3420-12	9779-513-12	.625	.740	1.084	2.250
3420-16	9779-513-16	.750	.927	1.309	2.125
3420-20	9779-513-20	.937	1.240	1.592	2.000
3420-24	9779-513-24	1.250	1.365	1.842	1.875

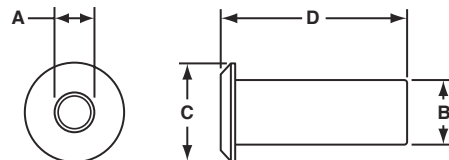

# AC Series/MS Accessories

## protection caps – plug

### PLUG PROTECTION CAP 10-329391-XX\*

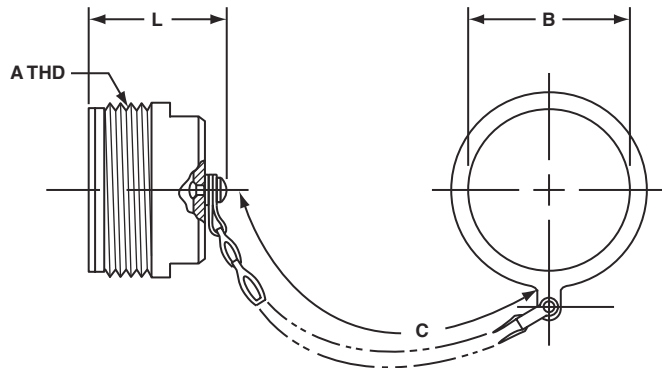

Assembly Number	A Thread Class 2A	B Dia. +.010 - .000	C Approx.	L Max.
10-329391-10	.625-24UNEF	.516	3.5	1.312
10-329391-11	.625-24UNEF	.641	3.5	1.312
10-329391-12	.750-20UNEF	.641	3.5	1.500
10-329391-14	.875-20UNEF	.766	3.5	1.500
10-329391-16	1.000-20UNEF	.891	3.5	1.500
10-329391-18	1.125-18UNEF	1.016	3.5	1.500
10-329391-20	1.250-18UNEF	1.141	4.0	1.500
10-329391-22	1.375-18UNEF	1.266	4.0	1.500
10-329391-24	1.500-18UNEF	1.391	4.5	1.500
10-329391-28	1.750-18UNS	1.641	4.5	1.500
10-329391-32	2.000-18UNS	1.891	5.0	1.500
10-329391-36	2.250-16UN	2.078	5.0	1.500
10-329391-40	2.500-16UN	2.328	5.0	1.500
10-329391-44	2.750-16UN	2.641	6.0	1.500

### PLUG PROTECTION CAP 10-229125-XX\*

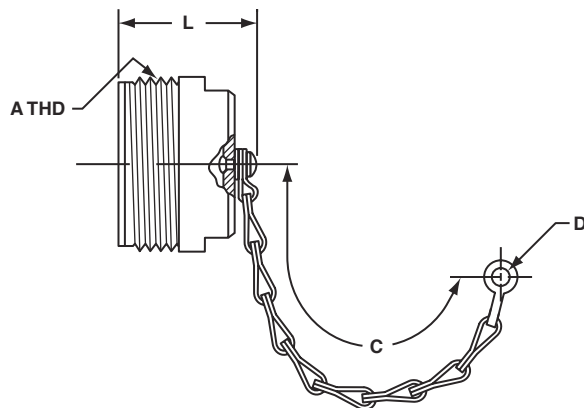

Assembly Number	A Thread Class 2A	C Approx.	D Ref.	L Max.
10-229125-10	.625-24NEF	3.0	.140	1.233
10-229125-12	.750-20UNEF	3.5	.140	1.421
10-229125-14	.875-20UNEF	3.5	.140	1.421
10-229125-16	1.000-20UNEF	3.5	.140	1.421
10-229125-18	1.125-18NEF	3.5	.140	1.421
10-229125-20	1.250-18NEF	3.5	.193	1.421
10-229125-22	1.375-18NEF	3.5	.193	1.421
10-229125-24	1.500-18NEF	4.5	.193	1.421
10-229125-28	1.750-18NS	4.5	.193	1.421
10-229125-32	2.000-18NS	5.0	.193	1.421
10-229125-36	2.250-16UN	5.0	.193	1.421
10-229125-40	2.500-16UN	5.0	.193	1.421

### PLUG PROTECTION CAP MS25042-XXDA\*

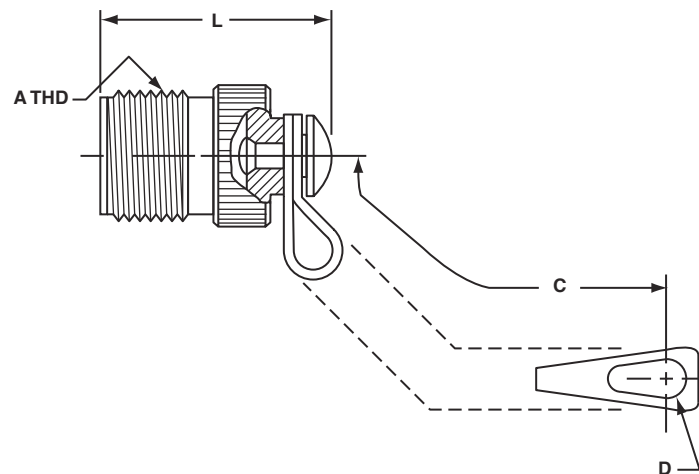

MS Number	A Thread Class 2A	B Dia. +.010 - .005	C Approx.	L Max.
MS25042-8DA	.500-28UNEF	.156	4.00	.969
MS25042-10DA	.625-24UNEF	.156	4.00	.969
MS25042-12DA	.750-20UNEF	.156	4.50	1.156
MS25042-14DA	.875-20UNEF	.156	4.50	1.156
MS25042-16DA	1.000-20UNEF	.156	4.50	1.156
MS25042-18DA	1.125-18UNEF	.156	4.50	1.156
MS25042-20DA	1.250-18UNEF	.187	5.00	1.156
MS25042-22DA	1.375-18UNEF	.187	5.00	1.156
MS25042-24DA	1.500-18UNEF	.187	5.50	1.156
MS25042-28DA	1.750-18UNS	.187	7.75	1.156
MS25042-32DA	2.000-18UNS	.218	7.75	1.156
MS25042-36DA	2.250-16UN	.218	7.75	1.156
MS25042-40DA	2.500-16UN	.218	7.75	1.156

\* Protective caps are illustrated with sash chains and are available with beaded chains or without chains. Optional terminations are also available. Consult Amphenol, Sidney, NY when ordering.

# AC Series/MS Accessories

## protection caps – receptacle

### RECEPTACLE PROTECTION CAP 10-329392-XX\*

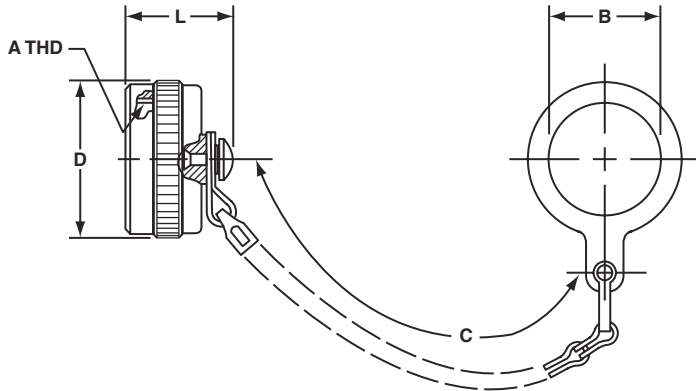

Assembly Number	A Thread Class 2B	B Dia. Min.	C Approx.	D Dia. Max.	L Max.
10-329392-10	.625-24UNEF	.516	3.5	.875	.793
10-329392-12	.750-20UNEF	.641	3.5	1.000	.793
10-329392-14	.875-20UNEF	.766	3.5	1.125	.793
10-329392-16	1.000-20UNEF	.891	3.5	1.250	.793
10-329392-18	1.125-18UNEF	1.016	3.5	1.375	1.024
10-329392-20	1.250-18UNEF	1.141	4.0	1.500	1.024
10-329392-22	1.375-18UNEF	1.266	4.0	1.625	1.024
10-329392-24	1.500-18UNEF	1.391	4.5	1.750	1.024
10-329392-28	1.750-18UNS	1.641	4.5	2.000	1.024
10-329392-32	2.000-18UNS	1.891	5.0	2.250	1.024
10-329392-36	2.250-16UN	2.078	5.0	2.500	1.024
10-329392-40	2.500-16UN	2.328	5.0	2.656	1.024
10-329392-44	2.750-16UN	2.641	6.0	2.938	1.024

### RECEPTACLE PROTECTION CAP 10-422905-XXX\*

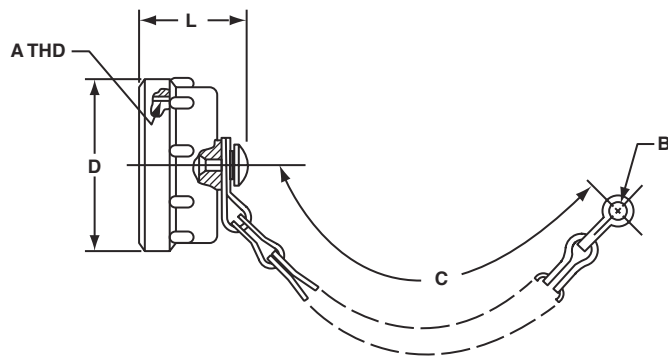

Assembly Number	A Thread Class 2B	B Ref.	C Approx.	D Dia. Max.	L Max.
10-422905-103	.625-24UNEF	.140	3.0	.875	.812
10-422905-123	.750-20UNEF	.140	3.5	1.000	.812
10-422905-143	.875-20UNEF	.140	3.5	1.125	.812
10-422905-163	1.000-20UNEF	.140	3.5	1.250	.812
10-422905-183	1.125-18UNEF	.193	3.5	1.375	1.031
10-422905-203	1.250-18UNEF	.193	4.0	1.500	1.031
10-422905-223	1.375-18UNEF	.193	4.0	1.625	1.031
10-422905-243	1.500-18UNEF	.193	4.5	1.750	1.031
10-422905-283	1.750-18UNS	.193	4.5	2.000	1.031
10-422905-323	2.000-18UNS	.193	5.0	2.250	1.031
10-422905-363	2.250-16UN	.193	5.0	2.500	1.031
10-422905-403	2.500-16UN	.193	5.0	2.656	1.031

### RECEPTACLE PROTECTION CAP MS25043-XXDA\*

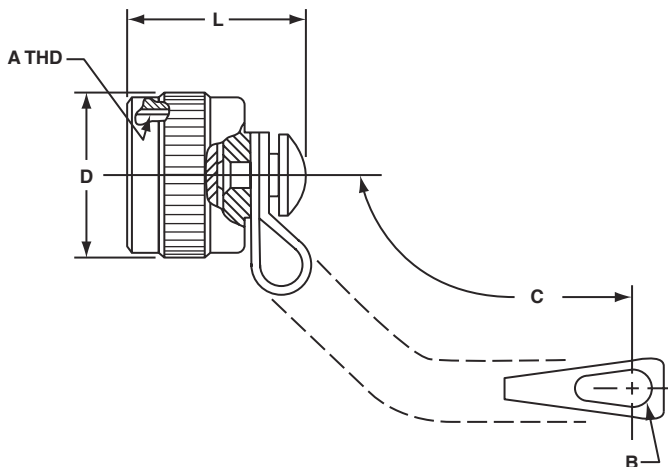

MS Number	A Thread Class 2B	B +.010 - .005	C Approx.	D Dia. Max.	L Max.
MS25043-8DA	.500-28UNEF	.140	4.00	.688	.750
MS25043-10DA	.625-24UNEF	.140	4.00	.815	.750
MS25043-12DA	.750-20UNEF	.140	4.50	1.000	.750
MS25043-14DA	.875-20UNEF	.140	4.50	1.125	.750
MS25043-16DA	1.000-20UNEF	.140	4.50	1.188	.750
MS25043-18DA	1.125-18UNEF	.140	4.50	1.344	.750
MS25043-20DA	1.250-18UNEF	.140	5.00	1.469	.750
MS25043-22DA	1.375-18UNEF	.140	5.00	1.594	.750
MS25043-24DA	1.500-18UNEF	.171	5.50	1.719	.750
MS25043-28DA	1.750-18UNS	.171	7.75	1.969	.812
MS25043-32DA	2.000-18UNS	.187	7.75	2.219	.812
MS25043-36DA	2.250-16UN	.187	7.75	2.469	.812
MS25043-40DA	2.500-16UN	.187	7.75	2.719	.812

\* Protective caps are illustrated with sash chains and are available with beaded chains or without chains. Optional terminations are also available. Consult Amphenol, Sidney, NY when ordering.

Cap without chain - 10-130969



# AC Series/MS

## dust caps

### 10-70500 RECEPTACLE DUST CAP

for external threads

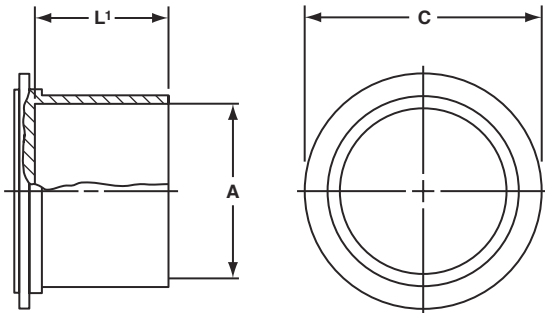

MS Shell Size	Order Number	A Dia. Nominal Thread	C Dia. ±.031	L <sup>1</sup> ±.062
8S	10-70500-8	.500	.750	.500
10S	10-70500-10	.625	.875	.500
10SL	10-70500-10	.625	.875	.500
12S	10-70500-12	.750	1.000	.500
12	10-70500-12	.750	1.000	.500
14S	10-70500-14	.875	1.125	.500
14	10-70500-14	.875	1.125	.500
16S	10-70500-16	1.000	1.250	.500
16	10-70500-16	1.000	1.250	.500
18	10-70500-18	1.125	1.375	.562
20	10-70500-20	1.250	1.500	.562
22	10-70500-22	1.375	1.625	.562
24	10-70500-24	1.500	1.750	.562
28	10-70500-28	1.750	1.938	.562
32	10-70500-32	2.000	2.250	.562
36	10-70500-36	2.250	2.500	.625
40	10-70500-40	2.500	2.750	.625

### 10-70506 PLUG DUST CAP

for internal threads

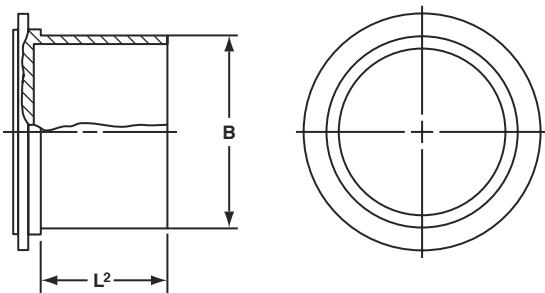

MS Shell Size	Order Number	B Dia. Min.	L <sup>2</sup> ±.125
8S	10-70506-8S	.469	.625
10S	10-70506-10S	.587	.625
10SL	10-70506-10S	.587	.625
12S	10-70506-12	.704	.625
12	10-70506-12	.704	.625
14S	10-70506-14	.828	.625
14	10-70506-14	.828	.625
16S	10-70506-16	.953	.625
16	10-70506-16	.953	.625
18	10-70506-18	1.072	.625
20	10-70506-20	1.197	.625
22	10-70506-22	1.322	.625
24	10-70506-24	1.447	.625
28	10-70506-28	1.697	.625
32	10-70506-32	1.947	.625
36	10-70506-36	2.190	.625
40	10-70506-40	2.440	.625

# AC Series/MS

## application tools, torque values

When proprietary crimp contacts are employed rather than the standard MS approved solder contacts, the following application tools are recommended for use. There is a possibility of additional crimping tools other than those included being available at present or in the future for this specific application.

Complete instructions for providing reliable crimped wire to contact terminations and inserting proprietary crimp contacts in AC Series connectors are available in publication L-757.

### TOOLING CHART

Crimping Tool	Positioner/ Turret	Contact Size	Contact Style	Insertion Tool	Removal Tool
M22520/1-01	*	16	Pin & Socket	11-7345	11-8250 Kit
M22520/1-01	*	12	Pin & Socket	11-7082	11-8250 Kit
**	**	8	Pin & Socket	11-8220	11-8250 Kit
**	**	4	Pin & Socket	11-7365-4 †	Pin 11-7370-4 † Socket 11-7674-2 †
**	**	0	Pin & Socket	11-7365-5 †	Pin 11-7370-5 † Socket 11-7674-3 †

\* Use Daniels Turret TH29-1 or Astro Tool Co. Turret 616266

\*\* For appropriate crimp tool and positioner refer to Pico Crimping Tool Co.

† Tools used with Arbor Press 11-7364

### RECOMMENDED TORQUE FORCES CONNECTOR BACKSHELLS

Size	In./Lb. Max.	Size	In./Lb. Max.
10SL	26	22	85
14S	44	24	90
16	50	28	114
16S	50	32	120
18	55	36	153
20	65	40	170

# Additional Products

## reverse bayonet coupling 5015 type connectors

**Amphenol has replaced the previously available AC-B series with the ACA-B.**

The ACA-B is a modification of the SAE AS50151 family designed for commercial and industrial environments requiring a rugged bayonet style connector, including heavy duty power and signal applications. A comprehensive selection of insert arrangements and accessory hardware are available to accommodate heavy-duty, commercial wire and cable. The rugged shell is made from aluminum alloy and plated with a variety of finishes to meet any application.

### Features of the ACA-B Reverse Bayonet series:

- Quick positive coupling with audible and tactile indication of full coupling.
- Intermateable with existing VG95234 connectors
- Rated 500 couplings minimum.
- No lockwiring required
- Inserts available in Neoprene material with alternate materials available upon request.
- Contacts available in gold and silver plating
- Available in both crimp and solder terminations
- Numerous finishes available, including cadmium free zinc alloy.
- Rugged construction; aluminum or stainless steel components.

Ask for Amphenol catalog IC-4 for further information on ACA-B Reverse Bayonet Connectors.

### GT Reverse Bayonet Connectors

Amphenol GT Series of Connectors are heavy duty, rugged and environmentally resistant, and are the preferred interconnect for the mass transit industry. They are also used in power generation, petrochemical industries and heavy equipment/geophysical marketplaces. GT connector utilize SAE AS50151 and commercial inserts and are intermateable with existing VG95234 connectors. Other features include:

- reverse bayonet coupling - quick mating, audible, visual and tactile full mating indicators.
- UL recognized
- rated to 2000 couplings min.
- operating temperature range:
  - with Neoprene inserts:  $-55^{\circ}\text{C}$  to  $+125^{\circ}\text{C}$
  - with Viton\*\* inserts:  $-50^{\circ}\text{C}$  to  $+200^{\circ}\text{C}$
  - with low smoke/flame retardant inserts:  $-55^{\circ}\text{C}$  to  $+125^{\circ}\text{C}$
- available in both crimp and solder termination
- rugged construction - aluminum or stainless steel components
- numerous military and commercial finishes available including gray zinc nickel (cadmium free)
- resilient inserts provide high dielectric strength and moisture barrier. IP67 performance in environmental versions
- over 40 varieties of shell styles and backend accessory combinations

Ask for Amphenol catalog IC-4 for further information on GT Series Connectors.



**Amphenol ACA-B Reverse Bayonet Connectors**



**Amphenol® GT Reverse Bayonet Connectors**

Amphenol Power GT Connectors are also available that incorporate RADSOK socket contacts. See page 31 for advantages and features of RADSOK contacts for high amperage capability.

# AC Series/MS Alternate Designs

## Amphe-Power™ 5015 Connectors

Amphenol offers the AC threaded series derived from the 5015 family that can be enhanced with high amperage RADSOK® contacts.

Design characteristics of the Amphe-Power 5015 connectors are:

- The RADSOK contact handles 50% to 150% higher amperages than standard contacts
- The RADSOK contact has a twisted hyperbolic, stamped grid configuration within the socket. This design ensures a large, coaxial, face-to-face surface area engagement. As male pin is inserted, axial members in the female half deflect, imparting high current flow across the connection with minimal voltage loss.
- Contact arrangements have RADSOK sockets in sizes 0, 4, 8 and 12 with standard contacts in size 16.

The contacts available in RADSOK and the amperages are as follows:

- Size 12 AWG can handle currents up to 35 amps.
- Size 8 AWG can handle currents up to 70 amps.
- Size 4 AWG can handle currents up to 120 amps.
- Size 0 AWG can handle currents up to 250 amps.
- AC threaded 5015 styles include: solid shell for general, non-environmental applications; pressurized style for use on pressurized bulkheads or pressure barriers; environmental resisting style with strain relief; lighter weight and shorter environmental resisting style

For more information ask for Amphenol brochure SL-391, Amphe-Power Connectors with RADSOK technology.



**Amphe-Power® 5015 Connectors**  
(AC Threaded 5015 type connectors with RADSOK® high amperage contacts)



**The RADSOK design - socket cylinder within female contact has twisted hyperbolic grid. Provides higher amperage capabilities with low insertion force and low temperature rise.**

## 5015 Connectors with PCB Contacts

Box mount receptacle 5015 type connectors can be supplied with PCB tails for mounting to a printed circuit board.

Consult Amphenol Industrial for part numbering.





**AMPHENOL CORPORATION**  
**Amphenol Industrial**

Phone: 888-364-9011

191 Delaware Avenue

Sidney, NY 13838-1395

**[www.amphenol-industrial.com](http://www.amphenol-industrial.com)**

**Notice:** Specifications are subject to change without notice. Contact your nearest Amphenol Corporation Sales Office for the latest specifications. All statements, information and data given herein are believed to be accurate and reliable but are presented without guarantee, warranty, or responsibility of any kind expressed or implied. Statements or suggestions concerning possible use of our products are made without representation or warranty that any such use is free of patent infringement and are not recommendations to infringe any patent. The user should not assume that all safety measures are indicated or that other measures may not be required. Specifications are typical and may not apply to all connectors.

## X-ON Electronics

Largest Supplier of Electrical and Electronic Components

*Click to view similar products for* [Circular MIL Spec Tools, Hardware & Accessories](#) *category:*

*Click to view products by* [Amphenol](#) *manufacturer:*

Other Similar products are found below :

[0113-201-2025](#) [600-079-06](#) [600-146-06](#) [M10-101982-143](#) [M10-101982-163](#) [M10-101983-183](#) [M10-150912-083](#) [M10-454396-008](#)  
[602GB18808](#) [CS3102A-22-14PW](#) [M2887615-CD](#) [627-009](#) [M38999/9-19B](#) [630A007NF083A](#) [630B007M051A](#) [630BJ003NF032H](#) [637-](#)  
[149NF04B](#) [M39029/29-215](#) [6408-203V-09273](#) [6426-201-11343](#) [650FS002NF16](#) [660-008NF14S7-01](#) [660-009M22H8-03](#) [660-013NF19U6-](#)  
[210](#) [660-015M10S6-17](#) [660-015NF10S5-01](#) [660-015NF14R3.5-01](#) [660-023NF19H6-19](#) [660-024NF11S12-01](#) [660-024NF11S3-01](#) [660-](#)  
[024NF17S4-109](#) [660-050XM17F4-01](#) [660-068NF25R6-30G](#) [660-070M23S8-04](#) [660-073MTCH9-20](#) [M83723/61-18W](#) [M83723/61-218R](#)  
[M83723/61-224W](#) [667-084-23C](#) [667-084-35C](#) [667-224NF16](#) [687-697NF-1](#) [M85049/94-10-A](#) [M85049/96-7-A](#) [M855282-10A01A](#)  
[M85528/2-10B](#) [M855282-18A01A](#) [M85528/2-22A01A](#) [M85528/2-22AA](#) [710HS460NF2508](#)