

# Amphenol Aerospace

## CONTACT US:

Amphenol Aerospace  
40-60 Delaware Avenue  
Sidney, NY 13838-1395

## Customer Service:

Mon - Fri 8AM - 5PM

Phone: (800) 678-0141

Fax: (607) 563-5157

Online: [www.amphenol-aerospace.com](http://www.amphenol-aerospace.com)



*Amphenol Aerospace, Amphenol Commercial Air,  
and Amphenol Industrial Operations Main Facility in Sidney, NY USA*

## ABOUT AMPHENOL AEROSPACE:

Amphenol Aerospace, a Division of Amphenol Corporation, is one of the largest manufacturers of interconnect products in the world for the Military, Commercial Aerospace and Industrial markets. Amphenol designs, manufactures and markets circular and rectangular, electronic, fiber optic, EMI/EMP filter, and a variety of special applications connectors and interconnect systems.

Our state-of-the-art facility is nestled at the foothills of the Catskill Mountains in Sidney, NY. The Amphenol complex houses many technologies including CNC machining, die-casting, molding, impact and extruding, plating, screw machining and process controls. Our fully equipped material evaluation lab and engineering organization utilize the latest in computer aided design software and analysis tools, allowing us to design, test, and qualify advanced interconnect systems. Amphenol's interconnect products are supplied to thousands of OEMs worldwide and are supported by our worldwide sales and engineering force, including the largest global network of electronic distributors.



### Customer-Centric:

Our **#1 priority** is our customers who deserve quality product on time.

### Accountable:

Clear owners, clear actions, clear results.

### Reliable:

What we build matters and quality is imperative.

### Enthusiastic:

Challenges create rewarding opportunities. Enthusiasm is contagious and we will spread it.

## QUALITY ASSURANCE:

Amphenol Aerospace has been awarded both AS9100 - Revision C and ISO9001:2008 Quality Assurance Certifications.

# MIL-DTL-38999, Series I LJT, II JT, III TV, HD

## Insert Availability and Identification Chart

38999

- III
- II
- I
- SJT
- Access
- Aquacon

Series	Series	Series	Military	MIL-DTL-27599 JT/LJT Solder	Crimp	Hermetics			Service Rating	Total Contacts	Contact Size												
						Class H	Class Y	TV*			23 HD	22D	22M	22	20	16	12	12 (Coax)	10 (Power)	8 (Coax)	8†† (Twinax)		
8-2■				P					M	2													
8-3■				X	NA	P	P		M	3													
	9-3■			X					Grounded	1													1
8-6				X	X	P	P		M	6					6								
	9-6			X	X	P	P		M	7					7								
	9-7■			X					M	7													
		9-9■							N	9	9												
	9-22■			X					I	2												2	
8-35					X	P	P		M	6		6											
	9-35	9-35	A35		X	P	P	P	M	6		6											
8-44					X	P	P		M	4												4	
	9-44				X				M	4													
		9-94■			◆				M	2												2	
8-97■				X					M	4					2							2	
8-98				S	X	P	P		I	3												3	
	9-98	9-98	A98	X	X	P	P	P	I	3												3	
	11-2*	11-2*	B2		X	P**			I	2												2	
10-4					3				I	4												4	
	11-4	11-4		X	2				I	4												4	
10-5				X	X	P	P		I	5												5	
	11-5	11-5	B5	X	X			P	I	5												5	
	11-6■			S					I	6												6	
10-13				X	X	P/S	P/S		M	13					13								
	11-13			X	X	P/S	P/S		N	19	19												
		11-19■							M	13					13								
10-35					X	P/S	P/S		M	13					13								
	11-35	11-35	B35		X	P/S	P/S	P	M	13					13								
		11-54■			X	◆			II	4					4								
10-98				X	X	P/S	P/S		I	6												6	
	11-98	11-98	B98	X	X	P/S	P/S	P	I	6												6	
10-99					X	P	P		I	7												7	
	11-99	11-99	B99		X	X		P	I	7												7	
12-3				X	X	◆	P	P	II	3												3	
	13-3■				P				II	3												3	
12-4				X	X	P	P		I	4												4	
	13-4*	13-4*	C4	X	X	P	P	P	I	4												4	
12-8				X	X	P	P		I	8												8	
	13-8	13-8	C8	X	X	P	P	P	I	8												8	
		13-13■							I, Fiber Optic	4												2**	2
12-22					X	P/S	P/S		M	22					22								
	13-22			X	X	P/S	P/S		M	22					22								
		13-26■			2				M	8					6								2
		13-32■							N	32	32												
12-35					X	P/S	P/S		M	22					22								
	13-35	13-35	C35		X	P/S	P/S	P	M	22					22								
		13-63■			◆				I	4												2	2
12-98				X	X	P/S	P/S		I	10												10	
	13-98	13-98	C98	X	X	P/S	P/S	P	I	10												10	
		15-AT■			X				I	13					10								3
14-4■					2				I	4													4
	15-4■	15-4■			2	◆			I	4													4
14-5				X	X	P	P		II	5												5	
	15-5*	15-5*	D5	X	X	P	P	P	II	5												5	

- X Completely tooled.
- + Majority of tooling is completed (contact Amphenol Aerospace for availability).
- ◆ Not tooled for 02-R.
- P Available with Pin contacts only
- S Available with Socket contacts only
- P/S Available with Pin contacts or Socket contacts
- \* Ground plane proprietary option available. Arrg. 9-5 is exclusively ground plane type.
- Not Mil-Qualified.
- ◇ 21-75 is Mil-Qualified with twinax contacts only. Note: MS connector 21-75 is supplied with size 8 twinax. Commercial connector 21-75 is supplied with size 8 coax.

- HD designates High Density 38999 Series III insert patterns which use size 23 contacts only. Not rated over 175°C.
- \* Hermetic inserts - solder termination standard. (Contact Amphenol Aerospace for optional PCB or eyelet termination).
- \*\* Two size 16 contacts dedicated to fiber optics. See the Fiber Optic section for more information.
- \*\*\* For use in MIL-STD-1760 applications (see pages 75 and 76). For RG 180/U and RG 195/U cables only.
- † Size 8 Coax and Twinax are interchangeable.
- †† Size 8 Coax and Twinax are interchangeable.
- (2) Not Tooled for RP or 02RE
- (3) Pin inserts only, not tooled for RP or 02RE (Consult Amphenol Aerospace for avail.)
- (5) MS Connector 21-79 has provision for two size 8 coax contacts. Coax contacts are not supplied unless specified by customer.

# MIL-DTL-38999, Series I LJT, II JT, III TV, HD

## Insert Availability and Identification Chart

Series	Series	Series	Military	MIL-DTL-27599		Hermetics						Contact Size									
JT II	LJT I	TV III	III	JT/LJT Solder	Crimp	Class H	Class Y	TV*	Service Rating	Total Contacts	23 HD	22D	22M	22	20	16	12	12 (Coax)	8 (Coax)	8†† (Twinax)	4
14-15				X	X	P	P		I	15					14	1					
	15-15	15-15	D15	X	X	P/S	P/S	P	I												
14-18				X	X	P/S	P/S		I	18					18						
	15-18	15-18	D18	X	X	P/S	P/S	P	I												
14-19				X	X				I	19					19						
	15-19	15-19	D19		X	P	P	P	I												
14-35					X	P	P		M	37		37									
	15-35	15-35	D35		X	P/S	P/S	P	M												
14-37				X	X	P	P		M	37			37								
	15-37			X	X	P	P		M												
		15-55							N	55	55										
14-68					2	P	P		1	8						8					
	15-68			X	X																
14-97					X	P	P		I	12					8	4					
	15-97	15-97	D97	X	X	P	P	P	I												
	17-2	17-2	E2		X	◆			M	39		38									1
		17-EA							M	19		10			3	2	4				
		17-EC							M	41		32			9						
16-6					X	P	P		I	6										6	
	17-6	17-6	E6		X	P	P	P	I												
16-8				X	X	P	P		II	8						8					
	17-8*	17-8*	E8	X	X	P/S	P/S	P	II												
16-13					2				I	13						13					
	17-13				2				I												
	17-22	17-22*			◆				Coax	4							2	2			
	17-25	17-25			2				M	24		22						2			
16-26				X	X	P/S	P/S		I	26					26						
	17-26	17-26	E26	X	X	P/S	P/S	P	I												
16-35					X	P	P		M	55			55								
	17-35	17-35	E35	X	X	P	P	P	M												
16-42					X				M	42				42							
	17-42				P				M												
		17-52			X	◆			M	2											2
16-55				X	X	P/S	P/S		M	55			55								
	17-55			X	X	P/S	P/S		M												
		17-60			X				I/Coax	10		8						2			
		17-73							N	73	73										
16-99				X	X	P	P		I	23					21	2					
	17-99	17-99	E99	X	X	P	P		I												
		19-AD			X	◆			Inst.	17					16						1
		19-FA							M	23		6			8	7	2				
18-11				X	X	P	P		II	11						11					
	19-11*	19-11*	F11	X	X	P	P	P	II												
	19-18	19-18	F18		2	2			M	18		14									4
18-28				X	X				I	28					26	2					
	19-28	19-28	F28	X	P	X			I												
18-30				X	X				I	30					29	1					
	19-30			X	P				I												
		19-31			X				M	15		12					1		2		
18-32				X	X	P/S	P/S		I	32					32						
	19-32	19-32	F32	X	X	P/S	P/S	P	I												
18-35					X	P	P		M	66			66								
	19-35	19-35	F35		X	P	P	P	M												
18-53				X	X				M	53				53							
	19-53				P				M												
18-66				X	X	P	P		M	66			66								
	19-66				X	P	P		M												
	19-67			X	3	S	S		M	67			67								
18-68					2				I	18						18					
	19-68	19-68			3	S			I												
18-96					2				I	9							9				
		19-88							N	88	88										
20-1					X	P	P		M	79											
	21-1				X	P/S	P/S		M												

38999

- III
- II
- I
- SJT
- Access
- Aquacon

# MIL-DTL-38999, Series I LJT, II JT, III TV, HD

## Insert Availability and Identification Chart

38999

	Series	Series	Series	Military	MIL-DTL-27599 JT/LJT Solder	Crimp	Hermetics			Service Rating	Total	Contact Size													
	JT II	LJT I	TV III	III			H	Y	TV*			23 HD	22D	22M	22	20	16	16 (Cx)	12	12 (Cx)	10 (Power)	8 (Power)	8 (Cx)	8†† (Twinax)	4
20-2						X				M	65														
		21-2■				X																			
20-11■						3				I	11							11							
		21-11★	21-11★	G11		X																			
20-16					X	X	P/S	P/S		II	16							16							
		21-16★	21-16★	G16	X	X	P	P	P																
		21-25■								I	25														
		21-27■			X					I	27														
			21-29			X				I	27							19	4		4				
20-35						X	P	P		M	79			79											
		21-35	21-35	G35		X	P/S	P/S	P																
20-39					X	X	P	P	P	I	39														
		21-39	21-39	G39	X	X	P	P	P																
20-41					X	X	P	P	P	I	41														
		21-41	21-41	G41	X	X	P/S	P/S	P																
			21-48■							M	4														
		21-75★	21-75★◇	G75		2	X			N	M	4													
		21-79■	21-79■			2	X			II	19			17									4	(4)	
			21-121■							N	121	121											2	(2)	
22-1						X	P/S	P/S		M	100				100										
		23-1				X	P	P																	
22-2					X	X	P	P		M	85				85										
		23-2			X	X	P	P																	
		23-6★■	23-6★■		X	P				M	6													6	
22-14■						2	◆			I	14														
		23-14■	23-14■			2	◆																		
22-21					X	X	P	P		II	21														
		23-21★	23-21★	H21	X	X	P	P	P																
22-32					X	X	P	P		I	32														
		23-32■			X	P																			
		23-34■			X					I	34														
22-35						X	P/S	P/S		M	100			100											
		23-35	23-35	H35		X	P	P	P																
22-53■						P				I	53														
		23-53	23-53	H53	X	X	P/S	P/S	P																
			23-54■			X				M	53			40				9	4						
22-55					X	X	P	P		I	55														
		23-55	23-55	H55		X			P																
			23-63■			S				M	57			49				4	4						
		23-97■			X					II	16														
		23-99■			X					II	11														
			23-151■							N	151	151													
24-1						X	P	P		M	128				128										
		25-1				X	P	P																	
24-2						X				M	100														
		25-2				X																			
24-4						X	P	P		I	56														
		25-4	25-4	J4		X			P																
		25-7■	25-7	J7		X				M	99			97									2		
			25-8★	J8		◆				Twx	8													8	
			25-11***	J11		2	◆			N	11														
			25-16■							M	8														
			25-17■			◆				M	42			36										6	
24-19■						X	P	P		I	19														
		25-19★	25-19★	J19		X			P																
		25-20■	25-20***	J20		2	◆			N	30													3	

- X Completely tooled.
- + Majority of tooling is completed (contact Amphenol Aerospace for availability).
- ◆ Not tooled for 02-R.
- P Available with Pin contacts only
- S Available with Socket contacts only
- P/S Available with Pin contacts or Socket contacts
- ★ Ground plane proprietary option available. Arrg. 9-5, 26-62 is exclusively ground plane type.
- Not Mil-Qualified.
- ◇ 21-75 is Mil-Qualified with twinax contacts only.
- \* Hermetic inserts - solder termination standard. (Contact Amphenol Aerospace for optional PCB or eyelet termination).
- HD designates High Density 38999 Series III insert patterns which use size 23 contacts only. Not rated over 175°C.
- \*\* Two size 16 contacts dedicated to fiber optics. See the Fiber Optic Section for more information.
- \*\*\* For use in MIL-STD-1760 applications (see pages 75 and 76).
- † For RG 180/U and RG 195/U cables only.
- †† Size 8 Coax and Twinax are interchangeable.
- (2) Not Tooled for RP or 02RE
- (3) Pin inserts only, not tooled for RP or 02RE (Consult Amphenol for avail.)
- (4) MS connector 21-75 is supplied with size 8 twinax. Commercial connector 21-75 is supplied with size 8 coax.
- (5) MS Connector 21-79 has provision for two size 8 coax contacts. Coax contacts are not supplied unless specified by customer.
- (PWR) Suffix at end of part number to replace coax, twinax, and fiber contacts with power contacts.

## Insert Availability and Identification Chart

Series	Series	Series	Military	MIL-DTL-27599	JT/LJT Solder	Hermetics				Service Rating	Total Contacts	Contact Size											
						Crimp	H	Y	TV*			23 HD	22D	20	16	12 (Fiber)	12 (Coax)	10	8 (Coax)	8†† (Twinax)	8 (Quadrx)	4	
24-24						X	P	P		I	24				12		12						
	25-24★	25-24★	J24			X	P	P		I	25				16		5			4			
		25-26■*				+				I	25												
24-29						X				I	29												
	25-29★	25-29★	J29		X	X				I	29												
24-35						X	P	P		New													
	25-35	25-35	J35			X	P	P	P	M	128		128										
24-37						X				I	37												
	25-37★	25-37★	J37			X				I	37												
		25-41■								N	Inst.	41		22	3	11			2			3	
24-43■						3				I	43				23	20							
	25-43	25-43	J43		X	2	◆			I	43												
	25-46	25-46	J46			2	◆			I	46				40	4					2		
24-61						X	X	P	P	I	61				61								
	25-61	25-61	J61		X	X	P	P	P	I	61				61								
		25-62■*				X	◆			I	12					8							4
		25-90	J90			◆				I	46				40	4						2	
		25-187■								N	187		187										
		25-1A■								N	8					4							4
		25-AT■				X				M	60			31	12	11	2		2			2	
		25-F4■				X				M/I	66			49		13							

38999

- III
- II
- I
- SJT
- Access
- Aquacon

### TV SERIES III

#### SELECT SHELL SIZE - SPECIAL INSERT ARRANGEMENT

(Not Mil-Spec Qualified)

Shell Size-Insert Arrg.	Crimp	Hermetics*	Service Rating	Total Contacts	Comments	Contact Size			
						22D	20	16	12
9-2	X		I	2	Formerly Pyle		2		
15-4	X		II	4	Formerly Pyle			4	
15-25	X		M	25	Formerly Pyle	22		3	
17-20	X		M	20	Formerly Pyle	16			4
21-12	X		I	12	Formerly Pyle		3		9
21-21	X		M/Inst.	41	Improved sealing	32			9
21-99	X		M	16	Formerly Pyle	5			11
25-92	X		M	101	Formerly Pyle	92		9	
25-97	X		M	42	Formerly Pyle	26		3	13

### LJT SERIES I

#### SELECT SHELL SIZE - SPECIAL INSERT ARRANGEMENT

(Not Mil-Spec Qualified)

Shell Size-Insert Arrg.	Crimp	Service Rating	Total Contacts	Comments	Contact Size			
					22D	20	16	12
25-64	X		64	Formerly Pyle	40	8	10	6

- X Completely tooled.
- + Majority of tooling is completed (contact Amphenol Aerospace for availability).
- ◆ Not tooled for 02-R.
- P Pin inserts only (contact Amphenol Aerospace for socket availability).
- ★ Ground plane proprietary option available. Arrangement 9-5, 25-62 is exclusively ground plane type.
- Not Mil-Qualified.
- \* Hermetic inserts - solder termination standard. (Contact Amphenol Aerospace for optional PCB or eyelet termination).
- \*\* Two size 16 contacts dedicated to fiber optics. See the Fiber Optic section for more information.
- \*\*\* For use in MIL-STD-1760 applications (pgs. 75 and 76).
- † For RG 180/U and RG 195/U cables only.
- †† Size 8 Coax and Twinax are interchangeable.
- Note: 25L-3 and 25L-7 use longer shells.
- (PWR) Suffix at end of part number to replace coax, twinax, and fiber contacts with power contacts.

### SELECT NON-STANDARD SHELL SIZE

- Special Insert Arrangement

Shell Size-Insert Arrg.	Crimp	Hermetics*	Service Rating	Total Contacts	Contact Size				
					22D	20	8	4	0
25L-3	X		II	3			1	2	
25L-7	X		II	7			7		
33-3	X		II	3				1	2
33-5	X		II	5				5	
33-6	X		II	6			2	4	
37-5	X		II	4					4

(Insert arrangements requiring non-standard shells)

# MIL-DTL-38999, Series I LJT, II JT, III TV, HD

## Insert Arrangements

Front face of pin inserts illustrated

38999

- III
- II
- I
- SJT
- Access
- Aquacon

Shell Size & Insert Arrg. for:



<b>Series II JT</b>	8-2	8-3		8-6				8-35	8-44		8-97	8-98	
<b>Series I LJT</b>		9-3		9-6	9-7		9-22	9-35	9-44			9-98	11-2
<b>Series III TV</b>			9-5			9-9 HD		9-35		9-94		9-98	11-2
Service Rating	M	M	Grounded	M	M	N	I	M	M	M	M	I	I
Number of Contacts	2	3	1	6	7	9	2	6	4	2	2	3	2
Contact Size	20	20	8 Twinax	22M	22M	23	20	22D	22	20	22M 20	20	16

Shell Size & Insert Arrg. for:



<b>Series II JT</b>	10-4	10-5		10-13			10-35		10-98	10-99	12-3	12-4
<b>Series I LJT</b>	11-4	11-5	11-6	11-13			11-35		11-98	11-99	13-3	13-4
<b>Series III TV</b>	11-4	11-5			11-19 HD		11-35	11-54	11-98	11-99		13-4
Service Rating	I	I	I	M	N		M	II	I	I	II	I
Number of Contacts	4	5	6	13	19		13	4	6	7	3	4
Contact Size	20	20	20	22M	23		22D	22D	20	20	16	16

Shell Size & Insert Arrg. for:



<b>Series II JT</b>	12-8	12-22			12-35			12-98		14-4	14-5
<b>Series I LJT</b>	13-8	13-22			13-35			13-98		15-4	15-5
<b>Series III TV</b>	13-8		13-26	13-32 HD	13-35	13-63	13-98		15-AT	15-4	15-5
Service Rating	I	M	M	N	M	I	I	I	I	I	II
Number of Contacts	8	22	6 2	32	22	2 2	10	10 3	4	5	
Contact Size	20	22M	22D 12	23	22D	16 12	20	22D 12	12	16	

Shell Size & Insert Arrg. for:



<b>Series II JT</b>	14-15	14-18	14-19		14-35	14-37		14-68	14-97
<b>Series I LJT</b>	15-15	15-18	15-19		15-35	15-37		15-68	15-97
<b>Series III TV</b>	15-15	15-18	15-19	15-25	15-35		15-55 HD		15-97
Service Rating	I	I	I	M	M	M	N	I	I
Number of Contacts	14 1	18	19	22 3	37	37	55	8	8 4
Contact Size	20 16	20	20	22D 16	22D	22M	23	16	20 16

Shell Size & Insert Arrg. for:



<b>Series II JT</b>					16-6	16-8	16-13	
<b>Series I LJT</b>				17-2	17-6	17-8	17-13	17-22
<b>Series III TV</b>	17-EA	17-EC		17-2	17-6	17-8		17-22
Service Rating				M	I	II	I	Coax
Number of Contacts	10 3 2 4	32 9	38	1	6	8	13	2 2
Contact Size	22D 20 16 12	22D 20	22D	8 Twinax	12	16	16	12 Coax 8 Coax



HD: High Density HD38999 (use size 23 contacts only)

CONTACT LEGEND

# MIL-DTL-38999, Series I LJT, II JT, III TV, HD

## Insert Arrangements

Front face of pin inserts illustrated

38999

III
II
I
SJT
Access
Aquacon

Shell Size & Insert Arr. for:						
<b>Series II JT</b>		16-26	16-35	16-42	16-55	
<b>Series I LJT</b>	17-25	17-26	17-35	17-42	17-55	
<b>Series III TV</b>		17-26	17-35		17-52	17-60
Service Rating	M	I	M	M	M	I/Coax
Number of Contacts	22 2	26	55	42	55	8 2
Contact Size	22D 8 Coax	20	22D	22	8 Twinax 22M	22D 8 Coax

Shell Size & Insert Arr. for:						
<b>Series II JT</b>		16-99		18-11		18-28
<b>Series I LJT</b>		17-99		19-11	19-18	19-28
<b>Series III TV</b>	17-73 HD	17-99	19-FA	19-11	19-18	19-28
Service Rating	N	I	M	II	M	M
Number of Contacts	73	21 2	6 8 7 2	11	14 4	26 2
Contact Size	23	20 16	22D 20 16 12	16	22D 8 Twinax	20 16

Shell Size & Insert Arr. for:						
<b>Series II JT</b>	18-30		18-32	18-35	18-53	18-66
<b>Series I LJT</b>	19-30		19-32	19-35	19-53	19-66
<b>Series III TV</b>		19-31	19-32	19-35		
Service Rating	I	M	I	M	M	M
Number of Contacts	29 1	2 1 12	32	66	53	66
Contact Size	20 16	8 Coax 12 22D	20	22D	22	22M

Shell Size & Insert Arr. for:						
<b>Series II JT</b>		18-68		18-96		
<b>Series I LJT</b>	19-67	19-68				
<b>Series III TV</b>			19-88 HD		19-AD	19-FA
Service Rating	M	I	N	I	Inst.	M
Number of Contacts	67	18	88	9	16 1	6 8 7 2
Contact Size	22M	16	23	12	20 8 Twinax	22D 20 16 12

CONTACT LEGEND

--	--	--	--	--	--	--	--	--

HD: High Density HD38999  
(use size 23 contacts only)

# MIL-DTL-38999, Series I LJT, II JT, III TV, HD

## Insert Arrangements

38999

Front face of pin inserts illustrated

- III
- II
- I
- SJT
- Access
- Aquacon

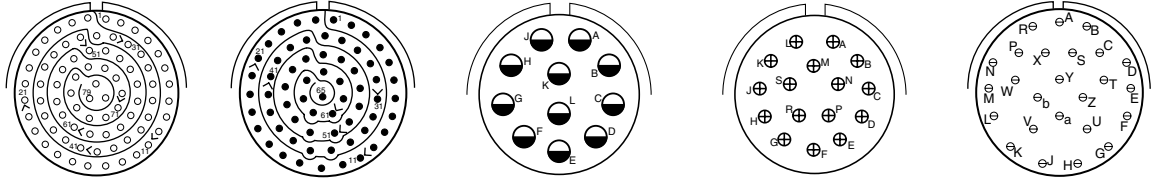

Shell Size & Insert Arrg. for:

Series II JT	20-1	20-2	20-11	20-16	
Series I LJT	21-1	21-2	21-11	21-16	21-25
Series III TV			21-11	21-16	
Service Rating	M	II	I	II	I
Number of Contacts	79	65	11	16	25
Contact Size	22M	22	12	16	20

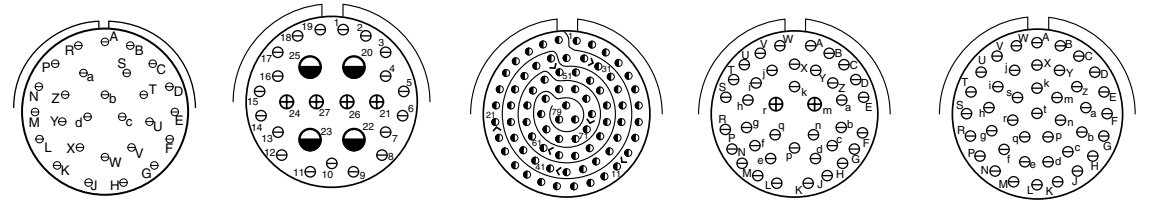

Shell Size & Insert Arrg. for:

Series II JT			20-35	20-39	20-41
Series I LJT	21-27		21-35	21-39	21-41
Series III TV		21-29	21-35	21-39	21-41
Service Rating	I	I	M	1	I
Number of Contacts	27	19 4 4	79	37 2	41
Contact Size	20	20 16 12	22D	20 16	20

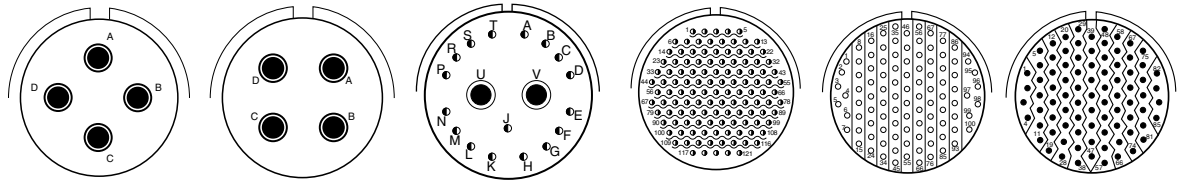

Shell Size & Insert Arrg. for:

Series II JT				22-1	22-2
Series I LJT		21-75	21-79	23-1	23-2
Series III TV	21-48	21-75	21-79	21-121 HD	
Service Rating	M	N	II	N	M
Number of Contacts	4	4	17 (See Note)	121	100
Contact Size	8 power	(See Note)	22D	23	22M

**HD:** High Density HD38999 (use size 23 contacts only)  
**Note:** MS connector 21-75 is supplied with four size 8 twinax contacts.  
 Commercial connector 21-75 is supplied with four size 8 coax contacts.  
 MS connector 21-79 has provision for two size 8 coax contacts.  
 Coax contacts are not supplied unless specified by customers.



CONTACT LEGEND 8 10 12 16 20 22 22M 22D 23



# MIL-DTL-38999, Series I LJT, II JT, III TV, HD

## Insert Arrangements

Front face of pin inserts illustrated

**38999**

III
II
I
SJT
Access
Aquacon



Shell Size &  
Insert Arrg. for:

<b>Series II JT</b>		22-14	22-21	22-32	
<b>Series I LJT</b>	23-6	23-14	23-21	23-32	23-34
<b>Series III TV</b>	23-6		23-21		
Service Rating	M	I	II	I	I
Number of Contacts	6	14	21	32	34
Contact Size	8 Twinax	12	16	20	20

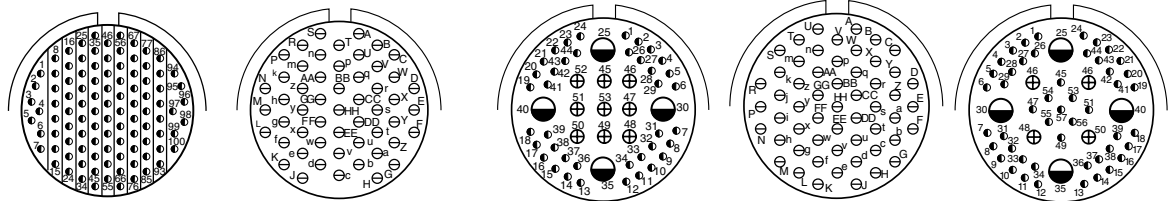

Shell Size &  
Insert Arrg. for:

<b>Series II JT</b>		22-35	22-53		22-55	
<b>Series I LJT</b>	23-35	23-53		23-54	23-55	23-63
<b>Series III TV</b>	M	I	M	I	M	
Service Rating	100	53	40 9 4	55	49 4 4	
Number of Contacts	22D	20	22D 16 12	20	22D 16 12	
Contact Size					Coax Coax	

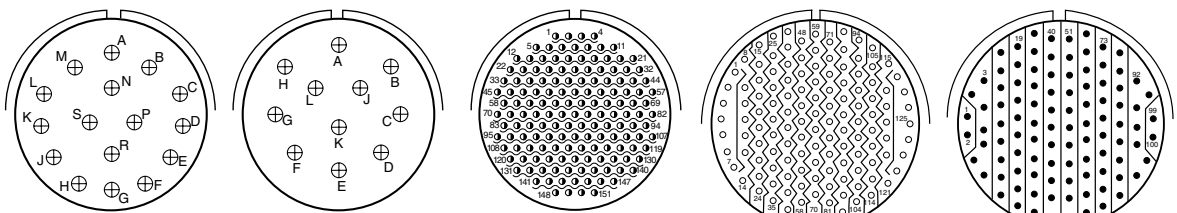

Shell Size &  
Insert Arrg. for:

<b>Series II JT</b>				24-1	24-2
<b>Series I LJT</b>	23-97	23-99		25-1	25-2
<b>Series III TV</b>			23-151 HD		
Service Rating	II	II	N	M	M
Number of Contacts	16	11	151	128	100
Contact Size	16	16	23	22M	22



**HD:** High Density HD38999  
(use size 23 contacts only)

**CONTACT LEGEND**

# MIL-DTL-38999, Series I LJT, II JT, III TV

## Insert Arrangements

Front face of pin inserts illustrated

38999

III

II

I

SJT

Access

Aquacon



Shell Size & Insert Arrg. for:

Series II JT	24-4		25-7		25-8		25-11	
Series I LJT	25-4		25-7		25-8		25-11***	
Series III TV	25-4		25-7		25-8		25-11***	
Service Rating	I		M		Twinax		N	
Number of Contacts	48	8	97	2	8	2	9	
Contact Size	20	16	22D	8 Twinax	8 Twinax	20	10	



Shell Size & Insert Arrg. for:

Series II JT	25-16		25-17		24-19		25-20	
Series I LJT	25-16		25-17		25-19		25-20***	
Series III TV	25-16		25-17		25-19		25-20***	
Service Rating	M		M		I		N	
Number of Contacts	6	2	36	6	19	10	13	3
Contact Size	20	4	22D	8 Twinax	12	20	16	8 Twinax 12 Coax

(With Matched Impedance)



Shell Size & Insert Arrg. for:

Series II JT	24-24		24-29		24-35	
Series I LJT	25-24		25-29		25-35	
Series III TV	25-24		25-26		25-35	
Service Rating	I		I		M	
Number of Contacts	12	12	16	5	4	128
Contact Size	16	12	20	12	8 Coax	22D

\*\*\* For use in MIL-STD-1760 applications (see pages 75 and 76).



CONTACT LEGEND 8 10 12 16 20 22 22M 22D 23

# MIL-DTL-38999, Series I LJT, II JT, III TV, HD

## Insert Arrangements

Front face of pin inserts illustrated

38999

III
II
I
SJT
Access
Aquacon



Shell Size &  
Insert Arr. for:

Series II JT

Series I LJT

Series III TV

Service Rating

Number of Contacts

Contact Size

	24-37					25-43		
	25-37					25-43		
	25-37		25-41			25-43		
	I		N/Inst.			I		
	37	22	3	11	2	3	23	20
	16	22D	20	16	12 Coax	8 Twinax	20	16



Shell Size &  
Insert Arr. for:

Series II JT

Series I LJT

Series III TV

Service Rating

Number of Contacts

Contact Size

		24-61						
	25-46	25-61						
	25-46	25-61		25-62	25-90			
	I	I		I	I			
	40	4	2	8	4	40	4	2
	20	16	8 Coax †	16	8	20	16	8 Twinax
				Ground Plane Only				



Shell Size &  
Insert Arr. for:

Series II JT

Series I LJT

Series III TV

Service Rating

Number of Contacts

Contact Size

	25-F4	25-187 HD		25-1A	25-AT				
	Size 22D=M, Balance =I	N		N	N				
	49	187		4	2	2	13	12	31
	22D	23		16	10	12	16	20	22D



† Coax contacts for RG180/U or RG195/U cable.

HD: High Density HD38999  
(use size 23 contacts only)

CONTACT LEGEND

# MIL-DTL-38999, Series III TV

## Special Insert Arrangements

38999

III

II

I

SJT

Access

Aquacon

Series III

Front face of pin inserts illustrated

Shell Size & Insert Arrg. for:



Series III TV	9-2	15-4*	15-25	
Service Rating	I	II	M	
Number of Contacts	2	4	22	3
Contact Size	20	16	22D	16

Shell Size & Insert Arrg. for:



Series III TV	17-20		21-12		21-21	
Service Rating	M		I		M/Inst.	
Number of Contacts	16	4	3	9	32	9
Contact Size	22D	12	20	12	22D	12

Shell Size & Insert Arrg. for:



Series III TV	21-99		25-92		25-97		
Service Rating	M		M		M		
Number of Contacts	5	11	92	9	26	3	13
Contact Size	22D	12	22D	16	22D	16	12

NOTE: Some specials shown here were formerly known as Pyle arrangements. Consult Amphenol for how to order information for connectors with these inserts. For further information on special arrangements consult Amphenol Aerospace, Sidney NY. \* Pyle 15-4 does not mate with Amphenol Tri-Start 15-4 insert.



CONTACT LEGEND 8 10 12 16 20 22 22M 22D 23\*

# MIL-DTL-38999, Series III TV

## Special Insert Arrangements

### Non-Standard Shells or Large Contacts

Front face of pin inserts illustrated



Shell Size &  
Insert Arrg. for:

Series III TV	25L-3		25L-7
Service Rating	II		II
Number of Contacts	1	2	7
Contact Size	8	4	8



Shell Size &  
Insert Arrg. for:

Series III TV	33-3		33-5	33-6	
Service Rating	II		II	II	
Number of Contacts	1	2	5	2	4
Contact Size	4	0	4	8	4



Shell Size &  
Insert Arrg. for:

Series III TV	37-5
Service Rating	II
Number of Contacts	4
Contact Size	0

NOTE: Some specials shown here were formerly known as Pyle arrangements. Consult Amphenol for how to order information for connectors with these inserts.

Consult Amphenol Aerospace for longer shell drawings.

**CONTACT LEGEND**



38999

- III
- II
- I
- SJT
- Access
- Aquacon

Series III

A

# PCB Contacts 38999, Series I LJT, II JT, III TV

## Insert Arrangements

38999

### INSERT ARRANGEMENT #8-3 / 9-3

Connector Type:	JT MIL-DTL-38999 Series II	LJT MIL-DTL-38999 Series I	Tri-Start MIL-DTL-38999 Series III	Number of Contacts	Contact Size	Service Rating
Insert Designation:	8-3	9-3	NA	3	20	M

#### Contact Locations

Front face of pin insert shown



\*Service Rating: M for MIL-DTL-38999

### INSERT ARRANGEMENT #8-35 / 9-35

Connector Type:	JT MIL-DTL-38999 Series II	LJT MIL-DTL-38999 Series I	Tri-Start MIL-DTL-38999 Series III	Number of Contacts	Contact Size	Service Rating
Insert Designation:	8-35	9-35	9-35	6	22D	M

#### Contact Locations

Front face of pin insert shown



All dimensions for reference only. For alternate rotations see page 46 for Series III, page 86 for Series II, and page 114 for Series I.  
Note: Shown in this catalog are the most common insert patterns for PCB applications. For availability of other arrangements, consult Amphenol Aerospace.

# PCB Contacts 38999, Series I LJT, II JT, III TV

## Insert Arrangements

### INSERT ARRANGEMENT #8-98 / 9-98

Connector Type:	JT MIL-DTL-38999 Series II	LJT MIL-DTL-38999 Series I	Tri-Start MIL-DTL-38999 Series III	Number of Contacts	Contact Size	Service Rating
Insert Designation:	8-98	9-98	9-98	3	20	I

#### Contact Locations

Front face of pin insert shown



### INSERT ARRANGEMENT #10-5 / 11-5

Connector Type:	JT MIL-DTL-38999 Series II	LJT MIL-DTL-38999 Series I	Tri-Start MIL-DTL-38999 Series III	Number of Contacts	Contact Size	Service Rating
Insert Designation:	10-5	11-5	11-5	5	20	I

#### Contact Locations

Front face of pin insert shown



All dimensions for reference only. For alternate rotations see page 46 Series III, page 86 Series II, and page 114 Series I.

Note: Shown in this catalog are the most common insert patterns for PCB applications. For availability of other arrangements, consult Amphenol Aerospace.

38999

III

II

I

SJT

Access

Aquacon

Series III, II, I

# PCB Contacts 38999, Series I LJT, II JT, III TV

## Insert Arrangements

38999

### INSERT ARRANGEMENT #10-6 / 11-6

Connector Type:	JT MIL-DTL-38999 Series II	LJT MIL-DTL-38999 Series I	Tri-Start MIL-DTL-38999 Series III	Number of Contacts	Contact Size	Service Rating
Insert Designation:	NA	11-6	NA	6	20	I

#### Contact Locations

Front face of pin insert shown



### INSERT ARRANGEMENT #10-35 / 11-35

Connector Type:	JT MIL-DTL-38999 Series II	LJT MIL-DTL-38999 Series I	Tri-Start MIL-DTL-38999 Series III	Number of Contacts	Contact Size	Service Rating
Insert Designation:	10-35	11-35	11-35	13	22D	M

#### Contact Locations

Front face of pin insert shown



All dimensions for reference only. For alternate rotations see page 46 for Series III, page 86 for Series II, and page 114 for Series I.  
Note: Shown in this catalog are the most common insert patterns for PCB applications. For availability of other arrangements, consult Amphenol Aerospace.



# PCB Contacts 38999, Series I LJT, II JT, III TV

## Insert Arrangements

### INSERT ARRANGEMENT #12-3 / 13-3

Connector Type:	JT MIL-DTL-38999 Series II	LJT MIL-DTL-38999 Series I	Tri-Start MIL-DTL-38999 Series III	Number of Contacts	Contact Size	Service Rating
Insert Designation:	12-3	13-3	NA	3	16	II

#### Contact Locations

Front face of pin insert shown



### INSERT ARRANGEMENT #12-35 / 13-35

Connector Type:	JT MIL-DTL-38999 Series II	LJT MIL-DTL-38999 Series I	Tri-Start MIL-DTL-38999 Series III	Number of Contacts	Contact Size	Service Rating
Insert Designation:	12-35	13-35	13-35	22	22D	M

#### Contact Locations

Front face of pin insert shown



All dimensions for reference only. For alternate rotations see page 46 for Series III, page 86 for Series II, and page 114 for Series I.  
Note: Shown in this catalog are the most common insert patterns for PCB applications. For availability of other arrangements, consult Amphenol Aerospace.

# PCB Contacts 38999, Series I LJT, II JT, III TV

## Insert Arrangements

### INSERT ARRANGEMENT #14-18 / 15-18

Connector Type:	JT MIL-DTL-38999 Series II	LJT MIL-DTL-38999 Series I	Tri-Start MIL-DTL-38999 Series III	Number of Contacts	Contact Size	Service Rating
Insert Designation:	14-18	15-18	15-18	18	20	I

#### Contact Locations

Front face of pin insert shown



### INSERT ARRANGEMENT #14-19 / 15-19

Connector Type:	JT MIL-DTL-38999 Series II	LJT MIL-DTL-38999 Series I	Tri-Start MIL-DTL-38999 Series III	Number of Contacts	Contact Size	Service Rating
Insert Designation:	14-19	15-19	15-19	19	20	I

#### Contact Locations

Front face of pin insert shown

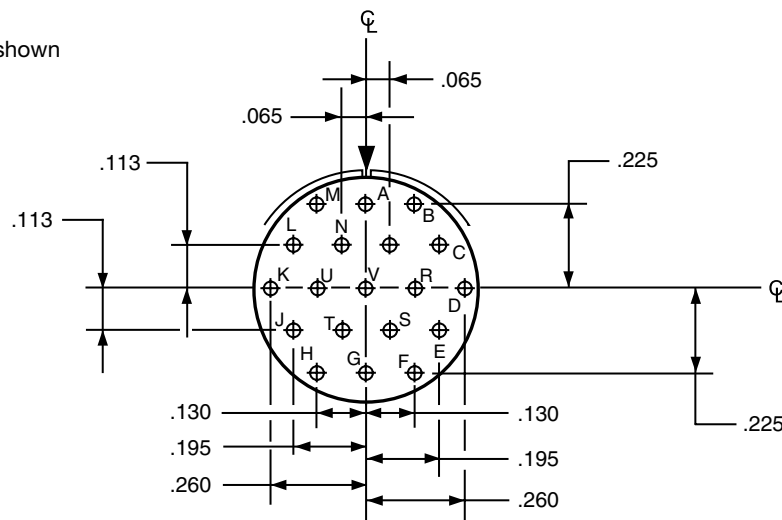

All dimensions for reference only. For alternate rotations see page 46 for Series III, page 86 for Series II, and page 114 for Series I.  
Note: Shown in this catalog are the most common insert patterns for PCB applications. For availability of other arrangements, consult Amphenol Aerospace.

# PCB Contacts 38999, Series I LJT, II JT, III TV

## Insert Arrangements

### INSERT ARRANGEMENT #14-35 / 15-35

<b>Connector Type:</b>	JT MIL-DTL-38999 Series II	LJT MIL-DTL-38999 Series I	Tri-Start MIL-DTL-38999 Series III	Number of Contacts	Contact Size	Service Rating
Insert Designation:	14-35	15-35	15-35	37	22D	M

#### Contact Locations

Front face of pin insert shown



Contact Hole Locations			Contact Hole Locations		
Contact Number	Location		Contact Number	Location	
	X Axis	Y Axis		X Axis	Y Axis
1	+045	+262	19	+045	+172
2	+123	+217	20	+123	+119
3	+211	+160	21	+170	+040
4	+254	+080	22	+170	-050
5	+266	-010	23	+123	-127
6	+247	-098	24	+045	-172
7	+200	-175	25	-045	-172
8	+130	-232	26	-123	-127
9	+045	-262	27	-170	-050
10	-045	-262	28	-170	+040
11	-130	-232	29	-123	+119
12	-200	-175	30	-045	+172
13	-247	-098	31	+045	+074
14	-266	-010	32	+090	-004
15	-254	+080	33	+045	-082
16	-211	+160	34	-045	-082
17	-123	+217	35	-090	-004
18	-045	+262	36	-045	+074
			37	.000	-004

### INSERT ARRANGEMENT #16-26 / 17-26

<b>Connector Type:</b>	JT MIL-DTL-38999 Series II	LJT MIL-DTL-38999 Series I	Tri-Start MIL-DTL-38999 Series III	Number of Contacts	Contact Size	Service Rating
Insert Designation:	NA	17-26	17-26	26	20	I

#### Contact Locations

Front face of pin insert shown



Contact Hole Locations			Contact Hole Locations		
Contact Number	Location		Contact Number	Location	
	X Axis	Y Axis		X Axis	Y Axis
A	.000	+321	R	-131	+293
B	+131	+293	S	-070	+177
C	+239	+214	T	+070	+177
D	+305	+099	U	+175	+094
E	+319	-034	V	+178	-036
F	+278	-161	W	+119	-151
G	+189	-260	X	.000	-203
H	+067	-314	Y	-119	-151
J	-067	-314	Z	-178	-036
K	-189	-260	a	-175	+094
L	-278	-161	b	.000	+065
M	-319	-034	c	.000	-065
N	-305	+099			
P	-239	+214			

All dimensions for reference only. For alternate rotations see page 46 for Series III, page 86 for Series II, and page 114 for Series I.

Note: Shown in this catalog are the most common insert patterns for PCB applications.

For availability of other arrangements, consult Amphenol Aerospace.

# PCB Contacts 38999, Series I LJT, II JT, III TV

## Insert Arrangements

38999

### INSERT ARRANGEMENT #16-35 / 17-35

<b>Connector Type:</b>	JT MIL-DTL-38999 Series II	LJT MIL-DTL-38999 Series I	Tri-Start MIL-DTL-38999 Series III	<b>Number of Contacts</b>	<b>Contact Size</b>	<b>Service Rating</b>
<b>Insert Designation:</b>	16-35	17-35	17-35	55	22D	M

### Contact Locations

Front face of pin insert shown



Contact Number	Contact Hole Locations	
	X Axis	Y Axis
1	-.312	+.086
2	-.312	-.004
3	-.312	-.094
4	-.242	+.221
5	-.234	+.131
6	-.234	+.041
7	-.234	-.049
8	-.234	-.139
9	-.234	-.229
10	-.172	+.279
11	-.156	+.176
12	-.156	+.086
13	-.156	-.004
14	-.156	-.094
15	-.156	-.184
16	-.156	-.274
17	-.089	+.316
18	-.078	+.221
19	-.078	+.131
20	-.078	+.041
21	-.078	-.049
22	-.078	-.139
23	-.078	-.229
24	-.078	-.319
25	.000	+.329
26	.000	+.176
27	.000	+.086

Contact Number	Contact Hole Locations	
	X Axis	Y Axis
28	.000	-.004
29	.000	-.094
30	.000	-.184
31	.000	-.274
32	+.089	+.316
33	+.078	+.221
34	+.078	+.131
35	+.078	+.041
36	+.078	-.049
37	+.078	-.139
38	+.078	-.229
39	+.078	-.319
40	+.172	+.279
41	+.156	+.176
42	+.156	+.086
43	+.156	-.004
44	+.156	-.094
45	+.156	-.184
46	+.156	-.274
47	+.242	+.221
48	+.234	+.131
49	+.234	+.041
50	+.234	-.049
51	+.234	-.139
52	+.234	-.229
53	+.312	+.086
54	+.312	-.004
55	+.312	-.094

All dimensions for reference only. For alternate rotations see page 46 for Series III, page 86 for Series II, and page 114 for Series I.  
 Note: Shown in this catalog are the most common insert patterns for PCB applications. For availability of other arrangements, consult Amphenol Aerospace.

# PCB Contacts 38999, Series I LJT, II JT, III TV

## Insert Arrangements

38999

- III
- II
- I
- SJT
- Access
- Aquacon

Series III, II, I

### INSERT ARRANGEMENT #18-11 / 19-11

Connector Type:	JT MIL-DTL-38999 Series II	LJT MIL-DTL-38999 Series I	Number of Contacts	Contact Size	Service Rating
	Insert Designation:	18-11			

#### Contact Locations

Front face of pin insert shown



### INSERT ARRANGEMENT #18-32 / 19-32

Connector Type:	JT MIL-DTL-38999 Series II	LJT MIL-DTL-38999 Series I	Tri-Start MIL-DTL-38999 Series III	Number of Contacts	Contact Size	Service Rating
	Insert Designation:	18-32	19-32			

#### Contact Locations

Front face of pin insert shown



Contact Hole Locations			Contact Hole Locations		
Contact Letter	Location		Contact Letter	Location	
	X Axis	Y Axis		X Axis	Y Axis
A	+0.066	+0.353	T	-.066	+0.353
B	+0.189	+0.305	U	.000	+0.230
C	+0.286	+0.217	V	+0.124	+0.193
D	+0.345	+0.098	W	+0.209	+0.095
E	+0.357	-.033	X	+0.228	-.033
F	+0.321	-.160	Y	+0.174	-.151
G	+0.242	-.265	Z	+0.065	-.221
H	+0.130	-.335	a	-.065	-.221
J	.000	-.359	b	-.174	-.151
K	-.130	-.335	c	-.228	-.033
L	-.242	-.265	d	-.209	+0.095
M	-.321	-.160	e	-.124	+0.193
N	-.357	-.033	f	.000	+0.096
P	-.345	+0.098	g	+0.096	.000
R	-.286	+0.217	h	.000	-.096
S	-.189	+0.305	j	-.096	.000

All dimensions for reference only. For alternate rotations see page 46 for Series III, page 86 for Series II, and page 114 for Series I.

Note: Shown in this catalog are the most common insert patterns for PCB applications. For availability of other arrangements, consult Amphenol Aerospace.

# PCB Contacts 38999, Series I LJT, II JT, III TV

## Insert Arrangements

38999

### INSERT ARRANGEMENT #18-35 / 19-35

Connector Type:	JT MIL-DTL-38999 Series II	LJT MIL-DTL-38999 Series I	Tri-Start MIL-DTL-38999 Series III	Number of Contacts	Contact Size	Service Rating
Insert Designation:	18-35	19-35	19-35	66	22D	M

#### Contact Locations

Front face of pin insert shown



### INSERT ARRANGEMENT #20-27 / 21-27

Connector Type:	JT MIL-DTL-38999 Series II	LJT MIL-DTL-38999 Series I	Tri-Start MIL-DTL-38999 Series III	Number of Contacts	Contact Size	Service Rating
Insert Designation:	20-27	21-27	NA	27	20	I

#### Contact Locations

Front face of pin insert shown



All dimensions for reference only. For alternate rotations see page 46 for Series III, page 86 for Series II, and page 114 for Series I.

Note: Shown in this catalog are the most common insert patterns for PCB applications. For availability of other arrangements, consult Amphenol.

# PCB Contacts 38999, Series I LJT, II JT, III TV

## Insert Arrangements

### INSERT ARRANGEMENT #20-35 / 21-35

<b>Connector Type:</b>	JT MIL-DTL-38999 Series II	LJT MIL-DTL-38999 Series I	Tri-Start MIL-DTL-38999 Series III	<b>Number of Contacts</b>	<b>Contact Size</b>	<b>Service Rating</b>
Insert Designation:	20-35	21-35	21-35	79	22D	M

38999

- III
- II
- I
- SJT
- Access
- Aquacon

### Contact Locations

Front face of pin insert shown

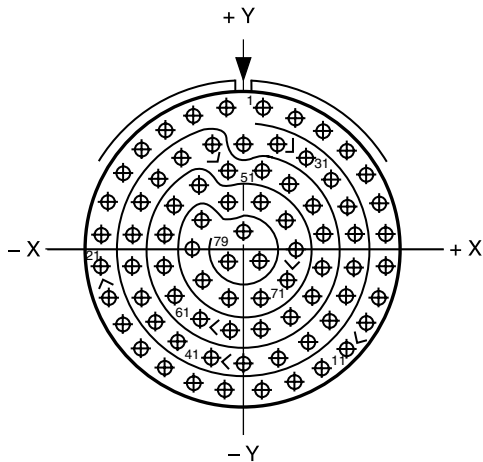

Contact Hole Locations		
Contact Number	Location	
	X Axis	Y Axis
1	+ .053	+ .426
2	+ .146	+ .404
3	+ .232	+ .362
4	+ .306	+ .302
5	+ .365	+ .227
6	+ .406	+ .141
7	+ .427	+ .048
8	+ .427	- .048

Contact Hole Locations		
Contact Number	Location	
	X Axis	Y Axis
9	+ .406	- .141
10	+ .365	- .227
11	+ .306	- .302
12	+ .232	- .362
13	+ .146	- .404
14	+ .053	- .426
15	- .053	- .426
16	- .146	- .404
17	- .232	- .362
18	- .306	- .302
19	- .365	- .227
20	- .406	- .141
21	- .427	- .048
22	- .427	+ .048
23	- .406	+ .141
24	- .365	+ .227
25	- .306	+ .302
26	- .232	+ .362
27	- .146	+ .404
28	- .053	+ .426
29	.000	+ .323
30	+ .098	+ .322
31	+ .184	+ .280
32	+ .258	+ .220
33	+ .311	+ .141
34	+ .332	+ .048
35	+ .332	- .048
36	+ .311	- .141
37	+ .258	- .220
38	+ .184	- .280
39	+ .098	- .322
40	.000	- .347
41	- .098	- .322
42	- .184	- .280

Contact Hole Locations		
Contact Number	Location	
	X Axis	Y Axis
43	- .258	- .220
44	- .311	- .141
45	- .332	- .048
46	- .332	+ .048
47	- .311	+ .141
48	- .258	+ .220
49	- .184	+ .280
50	- .098	+ .322
51	- .048	+ .241
52	+ .048	+ .241
53	+ .134	+ .199
54	+ .208	+ .139
55	+ .237	+ .048
56	+ .237	- .048
57	+ .208	- .139
58	+ .134	- .199
59	+ .048	- .241
60	- .048	- .241
61	- .134	- .199
62	- .208	- .139
63	- .237	- .048
64	- .237	+ .048
65	- .208	+ .139
66	- .134	+ .199
67	- .048	+ .146
68	+ .048	+ .146
69	+ .125	+ .090
70	+ .155	.000
71	+ .125	- .090
72	+ .048	- .146
73	- .048	- .146
74	- .125	- .090
75	- .155	.000
76	- .125	+ .090
77	.000	+ .053
78	+ .048	- .029
79	- .048	- .029

Series III, II, I

All dimensions for reference only. For alternate rotations see page 46 for Series III, page 86 for Series II, and page 114 for Series I. Note: Shown in this catalog are the most common insert patterns for PCB applications. For availability of other arrangements, consult Amphenol Aerospace.

# PCB Contacts 38999, Series I LJT, II JT, III TV

## Insert Arrangements

38999

### INSERT ARRANGEMENT #20-41 / 21-41

Connector Type:	JT MIL-DTL-38999 Series II	LJT MIL-DTL-38999 Series I	Tri-Start MIL-DTL-38999 Series III	Number of Contacts	Contact Size	Service Rating
Insert Designation:	20-41	21-41	21-41	41	20	I

#### Contact Locations

Front face of pin insert shown



Series III, II, I

All dimensions for reference only. For alternate rotations see page 46 for Series III, page 86 for Series II, and page 114 for Series I.  
 Note: Shown in this catalog are the most common insert patterns for PCB applications. For availability of other arrangements, consult Amphenol Aerospace.



# PCB Contacts 38999, Series I LJT, II JT, III TV

## Insert Arrangements

### INSERT ARRANGEMENT #22-35 / 23-35

Connector Type:	JT MIL-DTL-38999 Series II	LJT MIL-DTL-38999 Series I	Tri-Start MIL-DTL-38999 Series III
Insert Designation:	22-35	23-35	23-35

Number of Contacts	Contact Size	Service Rating
100	22D	M

38999

- III
- II
- I
- SJT
- Access
- Aquacon

### Contact Locations

Front face of pin insert shown



Contact Number	Location	
	X Axis	Y Axis
20	-.249	.000
21	-.249	-.095
22	-.249	-.190
23	-.249	-.285
24	-.249	-.380
25	-.166	+.428
26	-.166	+.333
27	-.166	+.238
28	-.166	+.143
29	-.166	+.048
30	-.166	-.047
31	-.166	-.142
32	-.166	-.237
33	-.166	-.332
34	-.166	-.427
35	-.083	+.475
36	-.083	+.380
37	-.083	+.285
38	-.083	+.190
39	-.083	+.095
40	-.083	.000
41	-.083	-.095
42	-.083	-.190
43	-.083	-.285
44	-.083	-.380
45	-.083	-.475
46	.000	+.428
47	.000	+.333
48	.000	+.238
49	.000	+.143
50	.000	+.048
51	.000	-.047
52	.000	-.142
53	.000	-.237
54	.000	-.332
55	.000	-.427
56	+.083	+.475
57	+.083	+.380
58	+.083	+.285
59	+.083	+.190

Contact Number	Location	
	X Axis	Y Axis
60	+.083	+.095
61	+.083	.000
62	+.083	-.095
63	+.083	-.190
64	+.083	-.285
65	+.083	-.380
66	+.083	-.475
67	+.166	+.428
68	+.166	+.333
69	+.166	+.238
70	+.166	+.143
71	+.166	+.048
72	+.166	-.047
73	+.166	-.142
74	+.166	-.237
75	+.166	-.332
76	+.166	-.427
77	+.249	+.380
78	+.249	+.285
79	+.249	+.190
80	+.249	+.095
81	+.249	.000
82	+.249	-.095
83	+.249	-.190
84	+.249	-.285
85	+.249	-.380
86	+.332	+.333
87	+.332	+.238
88	+.332	+.143
89	+.332	+.048
90	+.332	-.047
91	+.332	-.142
92	+.332	-.237
93	+.332	-.332
94	+.428	+.241
95	+.467	+.154
96	+.488	+.061
97	+.415	.000
98	+.488	-.061
99	+.428	-.142
100	+.428	-.237

Contact Number	Location	
	X Axis	Y Axis
1	-.428	+.241
2	-.467	+.154
3	-.488	+.061
4	-.415	.000
5	-.488	-.061
6	-.428	-.142
7	-.428	-.237
8	-.332	+.333
9	-.332	+.238
10	-.332	+.143
11	-.332	+.048
12	-.332	-.047
13	-.332	-.142
14	-.332	-.237
15	-.332	-.332
16	-.249	+.380
17	-.249	+.285
18	-.249	+.190
19	-.249	+.095

Series III, II, I

All dimensions for reference only. For alternate rotations see page 46 for Series III, page 86 for Series II, and page 114 for Series I.  
 Note: Shown in this catalog are the most common insert patterns for PCB applications. For availability of other arrangements, consult Amphenol Aerospace.

# PCB Contacts 38999, Series I LJT, II JT, III TV

## Insert Arrangements

38999

### INSERT ARRANGEMENT #22-55 / 23-55

Connector Type:	JT MIL-DTL-38999 Series II	LJT MIL-DTL-38999 Series I	Tri-Start MIL-DTL-38999 Series III	Number of Contacts	Contact Size	Service Rating
Insert Designation:	22-55	23-55	23-55	55	20	I

#### Contact Locations

Front face of pin insert shown



### INSERT ARRANGEMENT #24-31 / 25-31

Connector Type:	JT MIL-DTL-38999 Series II	LJT MIL-DTL-38999 Series I	Tri-Start MIL-DTL-38999 Series III	Number of Contacts	Contact Size	Service Rating
Insert Designation:	24-31	NA	NA	31	16	I

#### Contact Locations

Front face of pin insert shown



All dimensions for reference only. For alternate rotations see page 46 for Series III, page 86 for Series II, and page 114 for Series I.  
Note: Shown in this catalog are the most common insert patterns for PCB applications. For availability of other arrangements, consult Amphenol Aerospace.

# PCB Contacts 38999, Series I LJT, II JT, III TV

## Insert Arrangements

### INSERT ARRANGEMENT #24-35 / 25-35

Connector Type:	JT MIL-DTL-38999 Series II	LJT MIL-DTL-38999 Series I	Tri-Start MIL-DTL-38999 Series III	Number of Contacts	Contact Size	Service Rating
Insert Designation:	24-35	25-35	25-35	128	22D	M

### Contact Locations

Front face of pin insert shown



Contact Hole Locations		
Contact Number	Location	
	X Axis	Y Axis
1	-.479	+.279
2	-.520	+.190
3	-.546	+.095
4	-.555	.000
5	-.546	-.095
6	-.520	-.190
7	-.479	-.279
8	-.424	+.357
9	-.415	+.190
10	-.415	+.095
11	-.415	.000
12	-.415	-.095
13	-.415	-.190
14	-.424	-.357
15	-.332	+.444
16	-.332	+.332
17	-.332	+.237
18	-.332	+.142
19	-.332	+.047
20	-.332	-.047
21	-.332	-.142
22	-.332	-.237
23	-.332	-.332
24	-.332	-.427
25	-.249	+.496
26	-.249	+.380
27	-.249	+.285
28	-.249	+.190

Contact Hole Locations		
Contact Number	Location	
	X Axis	Y Axis
29	-.249	+.095
30	-.249	.000
31	-.249	-.095
32	-.249	-.190
33	-.249	-.285
34	-.249	-.380
35	-.249	-.475
36	-.166	+.531
37	-.166	+.427
38	-.166	+.332
39	-.166	+.237
40	-.166	+.142
41	-.166	+.047
42	-.166	-.047
43	-.166	-.142
44	-.166	-.237
45	-.166	-.332
46	-.166	-.427
47	-.166	-.522
48	-.083	+.475
49	-.083	+.380
50	-.083	+.285
51	-.083	+.190
52	-.083	+.095
53	-.083	.000
54	-.083	-.095
55	-.083	-.190
56	-.083	-.285
57	-.083	-.380
58	-.083	-.475
59	.000	+.522
60	.000	+.427
61	.000	+.332
62	.000	+.237
63	.000	+.142
64	.000	+.047
65	.000	-.047
66	.000	-.142
67	.000	-.237
68	.000	-.332
69	.000	-.427
70	.000	-.555
71	+.083	+.475
72	+.083	+.380
73	+.083	+.285
74	+.083	+.190
75	+.083	+.095
76	+.083	.000
77	+.083	-.095
78	+.083	-.190

Contact Hole Locations		
Contact Number	Location	
	X Axis	Y Axis
79	+.083	-.285
80	+.083	-.380
81	+.083	-.475
82	+.166	+.531
83	+.166	+.427
84	+.166	+.332
85	+.166	+.237
86	+.166	+.142
87	+.166	+.047
88	+.166	-.047
89	+.166	-.142
90	+.166	-.237
91	+.166	-.332
92	+.166	-.427
93	+.166	-.522
94	+.249	+.496
95	+.249	+.380
96	+.249	+.285
97	+.249	+.190
98	+.249	+.095
99	+.249	.000
100	+.249	-.095
101	+.249	-.190
102	+.249	-.285
103	+.249	-.380
104	+.249	-.475
105	+.332	+.444
106	+.332	+.332
107	+.332	+.237
108	+.332	+.142
109	+.332	+.047
110	+.332	-.047
111	+.332	-.142
112	+.332	-.237
113	+.332	-.332
114	+.332	-.427
115	+.424	+.357
116	+.415	+.190
117	+.415	+.095
118	+.415	.000
119	+.415	-.095
120	+.415	-.190
121	+.424	-.357
122	+.479	+.279
123	+.520	+.190
124	+.546	+.095
125	+.555	.000
126	+.546	-.095
127	+.520	-.190
128	+.479	-.279

All dimensions for reference only. For alternate rotations see page 46 for Series III, page 86 for Series II, and page 114 for Series I.

Note: Shown in this catalog are the most common insert patterns for PCB applications. For availability of other arrangements, consult Amphenol Aerospace.

# PCB Contacts 38999, Series I LJT, II JT, III TV

## Insert Arrangements

38999

III

II

I

SJT

Access

Aquacon

Series III, II, I

### INSERT ARRANGEMENT #24-61 / 25-61

Connector Type:	JT MIL-DTL-38999 Series II	LJT MIL-DTL-38999 Series I	Tri-Start MIL-DTL-38999 Series III	Number of Contacts	Contact Size	Service Rating
Insert Designation:	24-61	25-61	25-61	61	20	I

### Contact Locations

Front face of pin insert shown



Contact Hole Locations			Contact Hole Locations		
Contact Number	Location		Contact Number	Location	
	X Axis	Y Axis		X Axis	Y Axis
A	+ .196	+ .500	h	+ .341	- .213
B	+ .314	+ .435	i	+ .251	- .314
C	+ .413	+ .343	j	+ .133	- .379
D	+ .485	+ .230	k	.000	- .402
E	+ .527	+ .101	m	- .133	- .379
F	+ .536	- .030	n	- .251	- .314
G	+ .511	- .164	p	- .341	- .213
H	+ .454	- .287	q	- .392	- .088
J	+ .368	- .391	r	- .399	+ .046
K	+ .259	- .470	s	- .362	+ .175
L	+ .134	- .519	t	- .285	+ .283
M	.000	- .537	u	- .173	+ .363
N	- .134	- .519	v	.000	+ .338
P	- .259	- .470	w	+ .147	+ .223
R	- .368	- .391	x	+ .237	+ .122
S	- .454	- .287	y	+ .267	- .010
T	- .511	- .164	z	+ .228	- .139
U	- .536	- .030	AA	+ .131	- .233
V	- .527	+ .101	BB	.000	- .267
W	- .485	+ .230	CC	- .131	- .233
X	- .413	+ .343	DD	- .228	- .139
Y	- .314	+ .435	EE	- .267	- .010
Z	- .196	+ .500	FF	- .237	+ .122
a	- .068	+ .454	GG	- .147	+ .223
b	+ .068	+ .454	HH	.000	+ .200
c	+ .173	+ .363	JJ	+ .105	+ .094
d	+ .285	+ .283	KK	+ .135	- .041
e	+ .362	+ .175	LL	.000	- .132
f	+ .399	+ .046	MM	- .135	- .041
g	+ .392	- .088	NN	- .105	+ .094
			PP	.000	.000

All dimensions for reference only. For alternate rotations see page 46 for Series III, page 86 for Series II, and page 114 for Series I.

Note: Shown in this catalog are the most common insert patterns for PCB applications. For availability of other arrangements, consult Amphenol Aerospace.

# MIL-DTL-38999, Series I LJT, II JT, III TV, HD

## Contact Ratings/ Service Ratings

### CONTACT RATING FOR TV III, HD, JT II, LJT I, SJT

Contact Size	Test Current (Amps)		Maximum Millivolt Drop Crimp*	Maximum Millivolt Drop Hermetic*
	Crimp	Hermetic		
23	5	3	73	85
22M	3	2	45	60
22D	5	3	73	85
22	5	3	73	85
20	7.5	5	55	60
16	13	10	49	85
12	23	17	42	85
10 (Power)	33	NA	33	NA
8 (Power)	46	NA	26	NA
4	80	NA	23	NA
0	150	NA	21	NA

\*When tested using silver plated wire.

Contact Size	Crimp Well Data		Solder Well Data	
	Well Diameter	Normal Well Depth	Well Diameter	Nominal Well Depth
23	.0345 ± .0010	.141	.0345 ± .0010	.130
22M	.028 ± .001	.141	.029 +.004 -.000	
22D	.0345 ± .0010	.141	.036 +.004 -.000	.094
22	.0365 ± .0010	.141	.036 +.004 -.000	.094
20	.047 ± .001	.209	.044 +.004 -.004	.125
16	.067 ± .001	.209	.078 +.000 -.004	.141
12	.100 ± .002	.209	.116 +.004 -.002	.141
10 (Power)	.137 ± .002	.355	NA	NA
8	.181 ± .002	.490	NA	NA
4	.281 ± .002	.490	NA	NA
0	.453 ± .002	.585	NA	NA

### MIL-DTL-38999 SERIES III STANDARD 500 CYCLE CONTACTS FOR TV AND CTV, P & S

Contact Size	TV/CTV Pins		TV/CTV Sockets	
	Military No.	Supersedes	Military No.	Supersedes
8 (Coax)*	M39029/60-367	MS27536	M39029/59-366	MS27535
8 (Power)	Contact Factory	"	"	"
8 (Twinax)	M39029/90-529**	N/A	M39029/91-530	N/A
10 (Power)	M39029/58-528	N/A	M39029/56-527	N/A
12	M39029/58-365	MS27493-12	M39029/56-353	MS27490-12
16	M39029/58-364	MS27493-16	M39029/56-352	MS27490-16
20	M39029/58-363	MS27493-20	M39029/56-351	MS27490-20
22D	M39029/58-360	MS27493-22D	M39029/56-348	MS27490-22D
4	N/A	N/A	N/A	N/A
0	N/A	N/A	N/A	N/A

Above part numbers include standard 500 cycle finish designation - gold plating over suitable underplate in accordance with SAE AS39029. For other finish variations, consult Amphenol Aerospace.

\*For use with RG180B/U and RG195A/U cable. For other size 8 coax or optional sizes 12 and 16 coax contacts available for use in Tri-Start connectors, see High Speed catalog or consult Amphenol Aerospace.

### MIL-DTL-38999 SERIES III 1500 CYCLE CONTACTS, CLASSES H & J

Contact Size	CTV Pins			CTV Sockets		
	Commercial No.	Military No.	Supersedes	Commercial No.	Military No.	Supersedes
12	10-597072-2X	M39029/107-623	-	10-597073-2X	M39029/106-617	-
16	10-597068-2X	M39029/107-622	-	10-597069-2X	M39029/106-616	-
20	10-597064-2X	M39029/107-621	-	10-597065-2X	M39029/106-615	-
22D	10-597058-3X	M39029/107-620	-	10-597061-2X	M39029/106-614	-

# MIL-DTL-38999, Series I LJT, II JT, III TV Thermocouple Contacts/Sealing Plugs

38999

III

II

I

SJT

Access

Aquacon

Series III, II, I

## MIL-DTL-38999 SERIES II JT/ SERIES I LJT/SJT SERIES CRIMP CONTACTS

Contact Size	JT/LJT/SJT Pins MS No.	JT Socket MS No.	LJT/SJT Sockets MS No.	Contact Size	JT/LJT Pins MS No.	JT Socket MS No.	LJT/SJT Sockets MS No.
8 (Coax)*	M39029/60-367	NA	M39029/59-366	20	M39029/58-363	M39029/57-357	M39029/56-351
8 (Twinax)	M39029/90-529**	NA	M39029/91-530	22	M39029/58-362	M39029/57-356	M39029/56-350
10 (Power)	M39029/58-528	NA	M39029/56-527	22M	M39029/58-361	M39029/57-355	M39029/56-349
12	M39029/58-365	M39029/57-359	M39029/56-353	22D	M39029/58-360	M39029/57-354	M39029/56-348
16	M39029/58-364	M39029/57-358	M39029/56-352				

## MIL-DTL-38999 SERIES II JT/ I LJT THERMOCOUPLE CONTACTS

Contact Size	Material	JT/LJT Pins	JT Sockets	LJT Sockets
20	Chromel	10-407862-310	10-407863-310	10-407236-310
	Alumel	10-407862-320	10-407863-320	10-407865-320
	Iron	10-407862-335	10-407863-335	10-407865-335
	Constantan	10-407862-342	10-407863-342	10-407865-342

Partial Listing. If you do not see the contact for your application, consult Amphenol Aerospace.

## MIL-DTL-38999 SERIES II JT/ I LJT THERMOCOUPLE CONTACTS PYLE VERSION

Contact Size	Pins (II JT/ I LJT)		Sockets (LJT)		Material
	Spec Number	Pyle Number	Spec Number	Pyle Number	
22D	M39029/87-472	T3-4022-10P	M39029/88-484	T3-4122-10P	CHROMEL
22D	M39029/87-471	T3-4022-10R	M39029/88-483	T3-4122-10R	ALUMEL
20	M39029/87-476	T3-4020-10P	M39029/88-488	TS-4120-10P	CHROMEL
20	M39029/87-475	T3-4020-10R	M39029/88-487	T3-4120-10R	ALUMEL
16	M39029/87-480	T3-4016-10P	M39029/88-492	T3-4116-10P	CHROMEL
16	M39029/87-479	T3-4016-10R	M39029/88-491	T3-4116-10R	ALUMEL

Above part numbers include standard finish designation - gold plating over suitable underplate in accordance with MIL-DTL-39029. For other finishes, consult Amphenol Aerospace. Note: 22M and 22D contacts are interchangeable. \*For use with RG180B/U and RG195A/U cable. For other size 8 coax or optional sizes 12 and 18 coax contacts available for use in JT/LJT connectors, Refer to the High Speed Catalog. \*\* For use with 17/M176-00002 cable.

## MIL-DTL-38999 SERIES III SEALING PLUGS

Contact Size	Commercial No.	Military No.
8 (Coax)	10-482099-8	N/A
8 (Twinax)	T3-4008-59P	N/A
8 (Power)	10-405996-83	MS27488-8-3
10 (Power)	T3-4010-59P	M85049/81-10
12	10-405996-122	MS27488-12-2
16	10-405996-162	MS27488-16-2
20	10-405996-202	MS27488-20-2
22D	10-405996-222	MS27488-22-2
4	10-405996-43	MS27488-4-3
0	10-405996-03	MS27488-0-3

## MIL-DTL-38999 SERIES II JT/ I LJT SEALING PLUGS

Contact Size	Commercial No.	Military No.
8 (Coax)	10-482099-8	MS27488-8
8 (Twinax)	T3-4008-59P	N/A
10 (Power)	10-576225	N/A
12	10-405996-122	MS27488-12-2
16	10-405996-162	MS27488-16-2
20	10-405996-202	MS27488-20-2
22	10-405996-222	MS27488-22-2
22M	10-405996-222	MS27488-22-2
22D	10-405996-222	MS27488-22-2

## SJT SEALING PLUGS

Contact Size	Commercial No.
8 (Coax)	10-482099-8
8 (Twinax)	10-482099-8
10 (Power)	NA
12	10-405996-012 Yellow
16	10-405996-016 Blue
20	10-405996-020 Red
22	10-405996-022 Black
22M	10-405996-022 Black
22D	10-405996-022 Black

\*\* For use with M17/M176-00002 cable.

† Optional design - see slash sheet MS39029.

For other contact options available for use in Tri-Start connectors (wire wrap, thermocouple, fiber optic), consult Amphenol.

# MIL-DTL-38999, Series I LJT, II JT, III TV

## Thermocouple Contacts/Sealing Plugs/Finishing Data

### SERVICE RATING\*\*

Service Rating	Suggested Oper. Voltage (Sea Level)		Test Voltage (Sea Level)	Test Voltage 50,000 Ft.	Test Voltage 70,000 Ft	Test Voltage 110,000 Ft.
	AC (RMS)	DC				
M	400	500	1300 VRMS	550 VRMS	350 VRMS	200 VRMS
N	300	450	1000 VRMS	400 VRMS	260 VRMS	200 VRMS
I	600	850	1800 VRMS	600 VRMS	400 VRMS	200 VRMS
II	900	1250	2300 VRMS	800 VRMS	500 VRMS	200 VRMS

\*\* Please note that the establishment of electrical safety factors is left entirely in the designer's hands, since they are in the best position to know what peak voltage, switching surges, transients, etc. can be expected in a particular circuit.

### FINISH DATA MIL-DTL-38999, TRI-START, SERIES III TV

#### ALUMINUM SHELL COMPONENTS NON-HERMETIC\*

Finish	Service Class	
	Military	Commercial
Anodic Coating (Non-Conductive)	C*	RX**
Electroless Nickel	F (Metal)*	RF
	M (Composite)	
Olive Drab Cadmium Plate Nickel Base	W (Metal)*	RW
	J (Composite)	
Stainless Steel with Nickel Plate (non-firewall)	L	
Stainless Steel with Nickel Plate (firewall)	S	RS
Stainless Steel	K	RK
Durmalon plated	T*	DT
Zinc-Nickel Plated	Z*	DZ
Electroless Nickel Space Grade	G	

\*\*Add Suffix (005) to part number.

#### HERMETIC SHELL COMPONENTS

Material/Finish	Service Class	
	Military	Commercial
Stainless Steel	Y	Y
Stainless Steel with Nickel Plate	N	YN

### FINISH DATA MIL-DTL-38999, SERIES I LJT, II JT

#### ALUMINUM SHELL COMPONENTS NON-HERMETIC

Finish	Suffix		Finish Plus "SR" Suffix	Indicated Finish Standard for JT Types Listed Below	Indicated Finish Standard for LJT Types Listed Below
	Military	Commercial			
Cadmium Plated Nickel Base	MS (A)	-	(SR)	JT/JTG/JTL/JTP	LJT/LJTP
Anodic Coating (Alumilite)	MS (C)	(005)	(300)	JTS/JTPS/JTLS	LJTPS/LJTS
Chromate Treated (Iridite 14-2)		(011)	(344)	JTN/JTPN/JTLN	LJTN/LJTPN
Olive Drab Cadmium Plate Nickel Base	MS (B)	(014)	(386)		
Electroless Nickel	MS (F)	(023)	(424)		
Nickel-PTFE Durmalon		(038)			
Space Grade		(453)			

#### HERMETIC CONNECTORS

Finish	Suffix		Indicated Finish Standard for JT Types Listed Below	Indicated Finish Standard for LJT Types Listed Below
	Military	Commercial		
Carbon Steel Shell Tin Plated Shell and Contacts			JT( )H / JT( )Y JTL( )H / JTL( )Y	LJT( )Y LJT( )H
Carbon Steel Shell Tin Plated Shell and Gold Plated Contacts	MS (D)			
Stainless Steel Shell Gold Plated Contacts	MS (E)	(162)	JTS( )Y JTLS( )Y	LJTS( )Y

# Amphenol RoHS Compliant Platings

## Alternative to Cadmium

38999

### DURMALON™

Amphenol's Answer to EU RoHS/ELV/Cadmium Free Restrictions  
Commercial, industrial & military markets are rapidly moving away from restricted materials such as Cadmium (Cd) & Hexavalent Chromium (Cr(VI)). Both of these restricted materials are toxic and are known carcinogens. Amphenol is offering an alternative finish that complies with all customer requirements tied to these specifications.

MIL-DTL-38999, Rev L has established new service classes for alternative finishes addressing these requirements for Cadmium replacement. Amphenol is using this and European Union Directive 2002/95/EC RoHS (Regulation of Hazardous Substances) as a guide to qualification for all domestic, global, commercial, industrial, & military specifications requiring the reduction or elimination of these restricted materials.

Amphenol has qualified Durmalon, with internal part number coding "DT" finish, which meets or exceeds the 38999 designated class "T" finish, Nickel Fluorocarbon Polymer. Durmalon is also EU RoHS compliant and is Cadmium free, Lead free, and Hexavalent Chromium free.

We also offer additional platings such as "DX", (Durmalon, heavy duty final plate) to support JSF, F-35 program. The DX plating is intended to meet higher corrosion Sulfur Dioxide (SO<sub>2</sub>)/salt fog requirements of JSF.

Cadmium has been applied to numerous components of land, sea and air weapon systems and NASA systems for many years as it provides sacrificial corrosion protection and excellent lubricity for threaded applications.

The Defense Logistics Agency (DLA) has added the following cadmium alternative finishes to MIL-DTL-38999, Rev L (and other connector specs):

- Nickel Fluorocarbon Polymer
- Zinc-Nickel

### AMPHENOL'S DURMALON™

Durmalon, like Olive-Drab Cadmium plating (Class W), meets 500 hours of dynamic salt spray, combined with 500 mating cycles and meets specified millivolt drop shell-to-shell conductivity. Durmalon also meets a 200° C temperature rating. Durmalon has been proven to meet this requirement as well as Potassium Formate-Deicer fluid testing performed by Boeing.

### BLACK ZINC NICKEL

Black Zinc Nickel is Amphenol's 2nd RoHS Compliant Plating Alternative to Cadmium

Amphenol is now offering a new RoHS compliant alternative to Cadmium. Black Zinc Nickel is a non-reflective and conductive black finish approved for 500 hrs salt spray making it an excellent choice for harsh environments. Black Zinc Nickel has been qualified by the DLA, with internal part number coding "DZ" finish, which meets or exceeds the 38999 designated class "Z" finish. Black Zinc Nickel is compatible with other platings and available on a wide variety of connectors and accessories including all MIL-DTL-38999 Series III connectors.

### APPLICATIONS

Interest for non-hazardous alternative finishes are gaining momentum & many customers are currently using Black Zinc Nickel for a broad number of applications. Black Zinc Nickel is typically used on applications for commercial aerospace and military defense, who are now moving away from toxic Cadmium to more environmentally friendly options.

### TESTING

Amphenol Aerospace has performed extensive testing on numerous alternative platings including Black Zinc Nickel. For specific applications please contact Amphenol Aerospace.



### APPLICATIONS

Interest for non-hazardous alternative finishes is gaining momentum & many customers are currently using Durmalon for a broad number of applications. Durmalon combines the unique lubrication and anti-wetting properties of PTFE with corrosion resistance, high conductivity and EU RoHS compliance in a non-reflective finish.

### TESTING

Amphenol Aerospace has performed extensive testing on numerous alternative platings with the most consistent performer being the Durmalon. For specific applications please contact Amphenol Aerospace.

Requirements	Cadmium	Durmalon™	Black Zinc Nickel
<b>Coupling Torque</b> Post 500 hr. salt	■	■	■
<b>Shell to Shell Conductivity</b> <2.5 millivolts	■	■	■
<b>Cycles of Durability</b> 500 mates	■	■	■
<b>Salt Spray</b> Dynamic 500 hours	■	■	■
<b>Temperature Rating</b> 175° C	■	■	■
Non-Reflective	■	■	■
EU RoHS/ELV Compliant*		■	■
Non-Magnetic	■	■	■
De-icing Fluid**		■	■

\* Meets EU RoHS/ELV maximum concentration values (MCV) of 1000 ppm (0.1% w/w) or (0.01% w/w) per homogenous material.

\*\* Potassium Formate/Acetate based de-icing fluids.

Note: Specifications are subject to change without notice.

Series III

A



# A



## TABLE OF CONTENTS FOR SECTION A

Combined MIL-DTL-38999 Series I, II, III	
Shell Size & Insert Arrangements Availability	2-5
Insert Arrangement Drawings	6-13
PCB Insert Arrangements	14-28
Contact - Ratings, Service Ratings, Finish Data	29-31
Amphenol RoHS Compliant Plating	32

### MIL-DTL-38999, Series III TV

Performance, Options	34, 35
Test Data	36
Weight Comparison (Composite vs. Metal)	37
Dualok	38
HD38999, High Density	39
Custom	40
Configurator	41
How to Order (Military & Commercial)	42-46
How to Order (Boeing BACC63)	47

### TV SHELL STYLES:

Crimp Wall Mounting Receptacle TVP00R (D38999/20) /CTVP00R (Military D38999/20)	48
Crimp Box Mounting Receptacle TVP02R / CTVP02R	49
Line Receptacle TV01, TVS01, CTV01, CTVS01	50
Crimp Jam Nut Receptacle TV07R (D38999/24) / CTV07R (Military D38999/24)	51
Straight Plug TV06, TVS06, CTV06, CTVS06 (Military D38999/26)	52
Crimp Flange Mounting Plug TV09R	53
Dualok Plug/Receptacle TV56, TVS56, CTV56, CTVS56	54
Crimp CLUTCH-LOK™ Straight Plug for High Vibration TV26/MTV26	55

### PCB:

PCB Wall Mounting, Back Panel TVP00, TVPS00	56
PCB Wall Mounting, Back Panel, Clinch Nuts, TVP10, TVPS10	57
PCB Wall Mounting, Double Flange, TVP40, TVPS40	58
PCB Box Mounting Receptacle, TVP02, TVPS02	59
PCB Box Mounting Receptacle, Clinch Nuts, TVP12, TVPS12	60
PCB Jam Nut Receptacle, TV07, TVS07	61
PCB Jam Nut Receptacle, Double Flange, TVP47, TVPS47	62
PCB Hermetic Box, Jam Nut, Solder, Weld Mounting	63-66

### HERMETIC:

Hermetic Box Mounting TVPS02Y(D38999/21)	.67
Hermetic Jam Nut Receptacle TVS07Y (D38999/23)	.68
Hermetic Solder Mounting TVSIY (D38999/25)	.69
Hermetic Weld Mounting TVSHIY (D38999/27)	.69

### BREAKAWAY:

Breakaway Fail-Safe Connectors	.70
How to Order Breakaway (Military)	71, 72
How to Order Breakaway (Commercial)	.73
Fail-Safe Lanyard Release Plug	.74
How to Order Breakaway MIL-STD-1760 (Military)	.75
TV Breakaway (D38999/31) for MIL-STD-1760	.76
TV Breakaway Commercial Version for D38999/31, Type 6	.77
How to Order Commercial Version D38999/31, Type 6	.78
Insert Arrangements for Breakaway Fail-Safe	.79
Breakaway Fail-Safe 88-725041, 88-725014	.80
Breakaway Hybrid, Low Profile Lanyard Release Plug	.81
Stores Management Type II, Rail Launch (MIL-STD-1760)	.81

### Accessories:

Section F	164-183
-----------	---------

# MIL-DTL-38999, Series III TV

## Performance

38999

III

II

I

SJT

Access

Aquacon

Series III

### TRI-START™ MIL-DTL-38999 SERIES III WITH METAL SHELLS - ALUMINUM, STAINLESS STEEL, CLASS K FIREWALL

Amphenol® Tri-Start MIL-DTL-38999\* Series III Connectors offer the highest performance capabilities for both general duty and severe environment applications. Meeting or exceeding MIL-DTL-38999 Series III requirements, the Tri-Start connector with standard metal shells (aluminum or stainless steel with several finish options) offers these features:

- **EMI Shielding** - solid metal-to-metal coupling, grounding fingers, electroless nickel plating, and thicker wall sections provide superior EMI shielding capability of 65dB minimum at 10 GHz
- **Contact Protection** - recessed pins in this 100% scoop-proof connector minimize potential contact damage
- **Moisture Resistance** - improved interfacial seal design helps prevent electrolytic erosion of contacts
- **Corrosion Resistance** - shells of stainless steel or cadmium over nickel plating withstand a 500 hour salt spray exposure
- **Vibration/Shock** - operates under severe high temperature vibration, through 200°C
- **Firewall Capability** - available in a stainless steel shell, class RK, RS
- **Lockwiring Eliminated** - unique, self-locking, quick coupling connector eliminates lockwiring
- **Quick Coupling** - completely mates and self-locks in a 360° turn of the coupling nut
- **Inventory Support Commonality** - uses standard MIL-DTL-38999 contacts, application tools, insert arrangements
- **Electrostatic Discharge Protection (ESD)** - protection for sensitive circuitry without diodes, varistors, etc., with the use of the Faraday Cage principle which shunts high voltage, high current discharge events (see page Amphenol Filter Section)
- **Hermetic**- air leakage limited to  $1 \times 10^{-7}$  cm<sup>3</sup> per second optional
- **Qualified Specifications** - Stainless Steel qualified to BACC63DB and BACC63DC specifications



PASSIVATED STAINLESS STEEL



ELECTROLESS NICKEL



OLIVE DRAB CADMIUM



DURMALON PLATED



ZINC NICKEL PLATED

### OFFER MORE VERSATILITY & OPTIONS THAN ANY OTHER INTERCONNECTION FAMILY!



HD38999

High reliability and increased versatility best describe Amphenol MIL-DTL-38999, Series III circular connectors. Originally designed for the harshest of environments and most demanding of applications, Amphenol MIL-DTL-38999 Series III, Tri-Start connectors continue to evolve in pace with the needs of an ever-changing market.



DUALOK

Amphenol Tri-Start connectors can be configured with a number of application specific technologies like:

- High Density HD38999
- Dualok
- PC Tails
- Filters
- Fail Safe
- CLUTCH-LOK
- Fiber Optics
- High Speed Contacts
- Hermetics
- Flex



FILTER



PC TAILS



FAIL SAFE

Flexibility aids in design optimization through the combination of different technologies within a common, time-tested, harsh environment connector body.



CLUTCH-LOK

For more information about options, please call 800-678-0141 or visit [www.amphenol-aerospace.com](http://www.amphenol-aerospace.com).



FIBER OPTICS



HIGH SPEED



HERMETIC



FLEX



Composite Connector Patents:  
4,268,103; 4,648,670; 4,682,832; 4,703,987.  
Clutch-Lok® Patent 6,152,753.

38999

III

II

I

SJT

Access

Aquacon

Series III

A

# MIL-DTL-38999, Series III TV, HD

## Test Data

### TRI-START, SERIES III TYPICAL SHIELDING EFFECTIVENESS TEST DATA

EMI/EMP SHIELDING EFFECTIVENESS dB  
TESTING BY TRIAXIAL METHOD



### TRI-START, SERIES III TYPICAL SHIELDING EFFECTIVENESS TEST DATA

EMI/EMP SHIELDING EFFECTIVENESS dB  
TESTING BY MODE STIRRING METHOD



### AMPHENOL® TRI-START CONNECTORS PROVIDE EMI/ EMP SHIELDING CAPABILITY WHICH EXCEEDS MIL-DTL-38999 SERIES III REQUIREMENTS.

The TV and CTV Series III connector with standard solid metal-to-metal coupling, EMI grounding fingers and conductive finishes have proven to be the ultimate in EMI/EMP shielding effectiveness. The charts illustrate shielding effectiveness data which is typical of Tri-Start connectors tested with the nickel finish (Class F-metal, Class M-composite) over a wide frequency range.

The vibration capability of the Tri-Start Series is shown in the chart below. This illustrates the most severe vibration envelope of any qualified connector available today.

These capabilities along with a +200°C, -65°C temperature rating and superior moisture sealing protection provide the user with a connector that can withstand the most rigorous application.

### TRI-START VIBRATION CRITERIA



\* Dependant on shell finish

Test data beyond 2GHz is subject to equipment variation.

NOTE: For test data information on the new Clutch-Lok Tri-Start, high vibration connectors, consult Amphenol Aerospace.

# MIL-DTL-38999, Series III TV

## Weight Comparisons (Composite vs. Metal)

Depending on the shell style, shell size and contact count, weight savings can range from 17% to 40% compared to standard aluminum product.  
**Tri-Start Weight in Ounces** (includes contacts)

	Wall Mount Receptacle (00) + Military D38999/20						Jam Nut Receptacle (07) + Military D38999/24						Plug (06) + Military D38999/26					
	Stainless Steel		Aluminum		Composite		Stainless		Aluminum		Composite		Stainless Steel		Aluminum		Composite	
	Pin	Socket	Pin	Socket	Pin	Socket	Pin	Socket	Pin	Socket	Pin	Socket	Pin	Socket	Pin	Socket	Pin	Socket
9-35	.7216	.7840	.3248	.3777	.2588	.3121	1.1472	1.2096	.4416	.5040	.3489	.4413	1.0736	1.1360	.4236	.4625	.2606	.2994
9-98	.7216	.7776	.2496	.3056	.1664	.2224	1.1472	1.2032	.4416	.4976	.3744	.4640	1.0736	1.1296	.3968	.4624	.2991	.2337
11-35	.9488	1.0800	.3632	.4960	.2753	.4081	1.4304	1.5632	.5936	.7264	.4679	.6007	1.2480	1.3808	.5312	.6389	.3450	.4582
11-98	.9488	1.0620	.3632	.4768	.2753	.3889	1.4304	1.5440	.5936	.7072	.4679	.5815	1.2480	1.3616	.5330	.6283	.3468	.4457
13-8	1.2096	1.3888	.4800	.6592	.3696	.5488	1.9104	2.0896	.7664	.9456	.6560	.8352	1.8048	1.9840	.7936	.9728	.5237	.5952
13-35	1.2160	1.4320	.4864	.7024	.3762	.5922	1.9168	2.1328	.7728	.9888	.6136	.8296	1.8112	2.0272	.8000	.8472	.5301	.6531
13-98	1.2160	1.4016	.4864	.6720	.3762	.5618	1.9168	2.1024	.7728	.9584	.6136	.7992	1.8112	1.9968	.7978	.9856	.5244	.7157
15-5	1.5312	1.7904	.6352	.8944	.5027	.7619	2.3792	2.6384	.9728	1.2320	.7749	1.0341	2.2704	2.5456	.9632	1.1719	.6450	.8467
15-18	1.5456	1.8416	.7760	.9456	.6432	.8128	2.3936	2.6896	.9872	1.2832	.8544	1.1504	2.2848	2.5808	.9776	1.2736	.6594	.8208
15-35	1.5424	1.8768	.6464	.9808	.5139	.8483	2.3904	2.7344	.9840	1.3280	.7861	1.1301	2.2816	2.6256	1.2179	1.3184	.8961	1.0002
17-6	2.1488	2.5904	.9360	1.3776	.7812	1.2228	2.9152	3.3568	1.2336	1.6752	.9940	1.4356	2.5008	3.1024	1.1408	1.7424	.8160	1.4176
17-26	2.1344	2.5600	.9216	1.3472	.7668	1.1924	2.9008	3.3264	1.2192	1.6448	.9796	1.4052	2.4864	2.9120	1.1264	1.3343	.8017	.8062
17-35	2.1360	2.6640	.9232	1.4512	.7684	1.2964	2.9024	3.4304	1.2208	1.7488	.9812	1.5092	2.4880	3.0160	1.1280	1.5497	.8033	1.2144
19-11	2.2592	2.6656	.9696	1.4528	.7925	1.2757	3.4352	3.9184	1.4720	1.9552	1.2033	1.6865	2.9808	3.4640	1.3472	1.8304	.9632	1.4464
19-32	2.1888	2.7264	.9760	1.5136	.7989	1.3365	3.4416	3.9792	1.4784	2.0160	1.2097	1.7473	2.9872	3.5248	1.3536	1.8912	.9696	1.5072
19-35	2.1920	2.8432	.9792	1.6304	.8021	1.4533	3.4448	4.0960	1.4816	2.1328	1.2129	1.8641	2.9904	3.6416	1.3568	2.0080	.9728	1.6240
21-11	2.7456	3.4640	1.3088	2.0272	1.1088	1.8272	3.9712	4.6896	1.8128	2.5312	1.6128	2.3312	3.4448	4.1632	1.7344	2.5312	1.3039	1.8710
21-16	2.6784	3.3168	1.2416	1.8800	1.0422	1.6806	3.9040	4.5424	1.7456	2.3840	1.4505	2.0889	3.3776	4.0160	1.6672	2.3168	1.2352	1.8736
21-35	2.6672	3.4992	1.2304	2.0624	1.0310	1.8630	3.8928	4.7248	1.7344	2.5664	1.4393	2.2713	3.3664	4.1984	1.6560	2.2309	1.2255	1.8003
21-41	2.6768	3.3600	1.2400	1.9232	1.0406	1.7238	3.9024	4.5856	1.7440	2.4272	1.4489	2.1321	3.3760	3.5792	1.6656	1.8688	1.2336	1.4368
23-21	3.0352	3.8624	1.4496	2.2768	1.2279	2.0551	4.2368	5.0640	1.9440	2.7712	1.6368	2.4640	3.7920	4.6192	1.9216	2.7488	1.4637	2.2896
23-35	3.0240	4.0448	1.4384	2.4592	1.2167	2.2375	4.2256	5.2464	1.9328	2.9536	1.6256	2.6464	3.7808	4.8016	1.9104	2.6087	1.4525	2.1507
23-53	2.8992	3.9072	1.4560	2.4816	1.2343	2.2599	4.2432	5.1088	1.9504	2.8160	1.6432	2.5088	3.7984	4.6640	1.9280	2.7936	1.4672	2.2384
25-4	3.4512	4.4800	1.7312	2.8816	1.4864	2.1904	4.8048	5.8272	2.2016	3.2480	1.9568	2.8720	4.2224	5.2496	2.2128	3.2560	1.7133	2.4163
25-19	3.5312	4.7264	1.8112	3.0064	1.5664	2.7616	4.8848	6.0816	2.2816	3.4784	2.0368	3.2336	4.3024	5.4992	2.2928	3.4896	1.7933	2.7058
25-20	3.8190	4.7150	2.0173	3.1125	1.7733	2.8512	5.1430	6.0380	2.4877	3.5421	2.1872	3.2416	4.4350	5.3300	2.2580	3.0182	1.8288	2.8928
25-35	3.4416	4.6656	1.7216	2.9456	1.4776	2.7016	4.7952	6.0192	2.1920	3.4160	1.8915	3.1155	4.2128	5.4368	2.2032	3.4272	1.7037	2.9277
25-61	3.4304	4.4848	1.7282	2.7648	1.4841	2.5208	4.7840	5.8384	2.1808	3.2352	1.8803	2.9347	4.2016	5.2560	2.1920	3.2464	1.6912	2.7456

All weight measurements are for reference only.

# High Vibration Dualok, 38999 Series III Type

## Features and Benefits

38999

The Dualok represents the latest in high performance connector designs from Amphenol. Featuring a newly developed locking mechanism, the Dualok plug ensures rock-solid coupling and metal-to-metal bottoming in the most severe vibration environments.

### DUALOK FEATURES AND BENEFITS INCLUDE:

- Mates with standard D38999 receptacles and utilizes standard D38999 inserts.
- Designed to withstand and stay mated under vibration levels that exceed MIL-DTL-38999 levels
- Dualok stainless steel provides a weight savings of up to 42% compared to standard D38999 stainless steel designs
- Stainless steel, aluminum, composite, or aluminum bronze materials of construction
- Dualok aluminum provides ~ 10% weight reduction over D38999 Aluminum
- Coupling mechanism that does not “settle” under vibration levels exceeding MIL-DTL-38999
- Metal-to-metal bottoming for maximum EMI shielding under extreme vibration

New High Vibration Dualok Connector



Weight Comparison Size #9 (Less Inserts)



### CLUTCH-LOK™ MIL-DTL-38999, SERIES III HIGH VIBRATION CONNECTOR



### OPTIONAL SHELL GEOMETRIES

Amphenol offers a number of different shell configurations to fit your needs

- Deep Reach Shells - For increased panel thickness
- Stand-off Flange Shells - For attachments to Printed Circuit Boards.
- Connector with Integral Strain Reliefs

The Tri-Start option CLUTCH-LOK offers all advantages of stainless steel/Class K firewall for MIL-DTL-38999 Series III connectors, plus a unique clutch design that actually tightens itself under vibration.

Features include:

- High degree of differential torque
- No settling back to the next ratchet tooth
- Completely intermateable with all existing MIL-DTL-38999
- Series III connectors
- Offers advantage in inaccessible, hard to reach areas where mating torque is difficult to apply and complete coupling is not verifiable by inspection

See page 34 for description,  
44 – 46 for ordering.



Series III

A

# High Density Interconnects

## HD38999: 9 to 187 Contacts

The HD38999 family of connectors has 30% more contact density than the highest density Mil Spec 38999 connectors of its size. This series of connectors was designed to utilize mil-specified 38999 components with the exception of the contacts and inserts arrangement. Utilizing existing mil-qualified 39029 size 23 contacts and 38999 insert materials, these connectors are essentially a drop-in replacement for the standard 38999 connector.

This connector design benefits users in a couple of different ways. For those users who need to increase the amount of contacts in their application, the HD38999 series allows them to do so without increasing the size of their connector. For users who are looking to decrease the overall size of their system, they can do so by using smaller shell sizes without decreasing the number of contacts.

Amphenol has qualified this series of connectors to the requirements of MIL-DTL-38999. Amphenol also manufactures this high density series in Filter, Hermetic and customized versions to fit our customer's needs. Please contact us if additional information is required.

### TECHNICAL DATA

HD38999 series was designed to meet and/or exceed the specifications of MIL-DTL-38999. The connector series has been tested to all the requirements of 38999 with the use of AS39029 size 23 contacts. Test reports are available upon request. The following is a summary of some of the performance requirements.

#### EMI SHIELDING EFFECTIVENESS:

Solid metal to metal coupling, EMI grounding fingers and conductive finishes have proven to be the ultimate in EMI/EMP shielding effectiveness. The following chart illustrated shielding effectiveness data which is typical in HD38999 connectors.



#### ELECTRICAL:

22 AWG: 5.0 AMPS  
24 AWG: 3.0 AMPS  
26 AWG: 2.0 AMPS  
28 AWG: 1.5 AMPS

Insulation Resistance: 5000 megohms min. @500 VDC 25C  
Dielectric Withstanding Voltage: 1000 VRMS@sea level

#### MECHANICAL:

**Metallic Shells:** Material: Aluminum alloy, Stainless Steel  
Protection: Electroless Nickel, O.D. Cadmium, Durmalon (Nickel PTFE), Zinc Nickel

**Composite Shells:** Material: Thermoplastic  
Protection: Electroless Nickel, O.D. Cadmium, Durmalon (Nickel PTFE), Zinc Nickel

**Contacts:** Material: Copper Alloy  
Protection: Gold over Nickel

**Insert Retention to Shell:** 100 psi in axial load

**Durability:** 500 full mating and unmating cycles

**Vibration:** 60G sine per MIL-DTL-38999L Para 4.5.23.2.1  
5G2 Random per EIA-364-28E, Test condition A  
1G2 Random per EIA-364-28E, Test condition I

**Shock:** Per EIA-364-27B, 300g

#### ENVIRONMENTAL:

**Operating Temperature:** -65°C to +175°C

**Salt Spray:**  
**Metallized:** Electroless Nickel: 48 hours  
Anodic Coating, O. D. Cadmium, Durmalon, Zinc Nickel: 500 hours

**Salt Spray Composite:** Electroless Nickel: 1000 hours  
O. D. Cadmium, Durmalon, Zinc Nickel: 500 hours



38999

- III
- II
- I
- SJT
- Access
- Aquacon

Series III

A

# Custom Designed HD38999 Connectors and Alignment Disks

38999

NEW CUSTOM DESIGNED HD38999 CONNECTORS - PROVIDE MORE INTERCONNECT SOLUTIONS:



## ALIGNMENT DISKS

Alignment disks keep contacts aligned for easier insertion into circuit boards. These are typically ordered with the connector - see step 7 of How to Order on page 47.



## FILTERED HD38999 CONNECTORS - FOR EMI/EMP PROTECTION

High density patterns are available in filter 38999 connectors - consult Amphenol Aerospace for ordering.

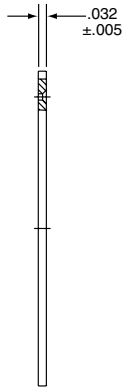
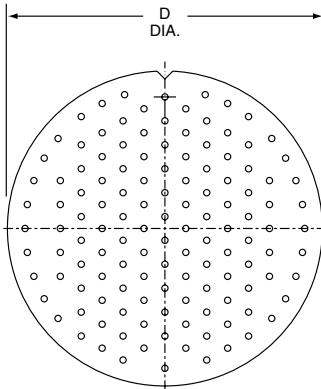

Shell Size	D Dia. ±.010
9	.234
11	.350
13	.500
15	.725
17	.750
19	.850
21	.953
23	1.147
25	1.250

## HD38999 FOR GIGABIT ETHERNET APPLICATIONS

The HD38999 is available for high speed (Gigabit Ethernet) data transmission in the size 9-9 insert pattern.

Data transmission performance of this connector insert:

- 10 Base T, 100 Base TX, and 1000 Base T networks using Cat 5e per TIA/EIA568B and Class D per ISO/IEC 11801.  
(Test report available - consult Amphenol Aerospace for more information)

Signal-Ground Pin Configuration  
Wiring Recommendations

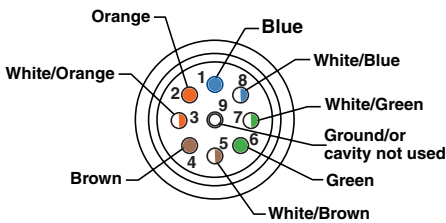

View Rear of Connector



HD38999 Connector with 9-9 Insert Pattern (Rear View)

Series III

A



# MIL-DTL-38999, Series III TV, Configurator

Online at [www.amphenol-aerospace.com](http://www.amphenol-aerospace.com)

Now you can build a part number for Military and Commercial MIL-DTL-38999 Series III through our online configurator, located on the home page of [www.amphenol-aerospace.com](http://www.amphenol-aerospace.com).

38999

III

II

I

SJT

Access

Aquacon

Series III



After building a part number, you have the option to download the drawing and specifications, buy if available through distribution channels, Request a Quote and the ability to download multiple part numbers to a list to manage your needs.



# Military to Commercial Shell Style Conversion Table

## How to Order (Military)

38999

MILITARY	DESCRIPTION	COMMERCIAL
D38999/20	Wall Mounting Receptacle	TVP00 or TVPS00 (AL & SS); CTVP00, CTVPS00 (Composite)
D38999/21	Hermetic Box Mounting Receptacle	TVPS02Y, TVPS02YN
D38999/23	Hermetic Jam Nut Receptacle	TVS07Y, TVS07YN
D38999/24	Jam Nut Receptacle	TV07, TVS07 (AL & SS); CTV00, CTVS00 (Composite)
D38999/26	Straight Plug	TV06, TVS06
D38999/25	Solder Mount Receptacle (Hermetic)	TVSI
D38999/27	Weld Mounted Receptacle (Hermetic)	TVSHI

### HOW TO ORDER: MILITARY

- 1.
- 2.
- 3.
- 4.
- 5.
- 6.

Connector Type	Shell Style	Service Class	Shell Size- Insert Arrangement	Contact Type	Alternate Keying Position
D38999/	20	J	G35	P	N

#### 1. CONNECTOR TYPE

38999/	MIL-DTL-38999 III
--------	-------------------

#### 2. SHELL STYLE

20	Wall Mount Receptacle
21	Box Mount Receptacle Hermetic
26	Straight Plug
24	Jam Nut Receptacle
23	Jam Nut Receptacle Hermetic
25	Solder Mount Receptacle Hermetic
27	Weld Mounted Receptacle, (Hermetic) Only

#### 3. SERVICE CLASS

Military	Finish	RoHS	Material	Material/ Description
C	Anodic Coating	■	Aluminum	200°C, 500 hour salt spray
F	Electroless Nickel	■	Aluminum	200°C, EMI shielding -65dB @ 10GHz, 48 hour salt spray
G	Electroless Nickel	■	Aluminum	200°C, Space grade, 48 hour salt spray
J	Olive Drab Cadmium		Composite	175°C, 2000 hours dynamic salt spray, EMI Shielding -50 dB@10 GHz specification min.
K	Passivated Stainless Steel	■	Stainless Steel	200°C, firewall capability, 500 hour salt spray resistance, EMI -45 dB @ 10 GHz specification min.
L	Stainless Steel w/ Nickel Plate	■	Stainless Steel	Corrosion resistant steel, 200°C, 500 hour salt spray, , non firewall, EMI shielding -65dB @ 10GHz specification min.
M	Electroless Nickel	■	Composite	200°C, EMI shielding -65dB @ 10GHz, 2000 hours dynamic salt spray
N	Stainless Steel w/ Nickel Plate	■	Stainless Steel	Hermetic connectors, corrosion resistant steel, 200°C
S	Stainless Steel w/ Nickel Plate	■	Stainless Steel	Non-hermetic connectors, corrosion resistant steel, 200°, firewall capability, 500 hour salt spray, EMI shielding -65dB @ 10GHz specification min.
T	Durmalon plated	■	Aluminum	Nickel-PTFE alternative to Cadmium, 175°C, 500 hour salt spray, EMI -50dB at 10GHz specification min.
W	Olive Drab Cadmium		Aluminum	175°C , 500 hour salt spray, EMI Shielding -50 dB@10 GHz specification min.
Y	Stainless Steel	■	Stainless Steel	Hermetic seal, 200°C passivated stainless steel
Z	Zinc-Nickel Plated	■	Aluminum	Zinc-Nickel Alternative to Cadmium, +175°C, 500 hour salt spray, EMI Shielding -50 dB @ 10 GHz specification min.

Series III

A

### 4. SELECT A SHELL SIZE & INSERT ARRANGEMENT SEE PAGES 2-5

Shell Size & Insert Arrangements are on pages 2-5. First number represents Shell Size, second number is the Insert Arrangement.

Triple Start Threads									Mil Shell Size
A	B	C	D	E	F	G	H	J	Amphenol Shell size
9	11	13	15	17	19	21	23	25	

### 5. CONTACT TYPE

<b>P</b>	500 Cycle Pin Contacts, if require Less Contacts place (LC) at the end of part number
<b>S</b>	500 Cycle Socket Contacts, if require Less Contacts place (LC) at the end of part number
<b>H</b>	1500 Pin Cycle Contacts
<b>J</b>	1500 Socket Cycle Contacts
<b>A</b>	Less Pin Contacts
<b>B</b>	Less Socket Contacts
<b>X</b>	Eyelet contacts, hermetics only

### 6. ALTERNATE KEY POSITION

Key/Keyway Position					
N	A	B	C	D	E

#### KEY/KEYWAY POSITION

A plug with a given rotation letter will mate with a receptacle with the same rotation letter. The angles for a given connector are the same whether it contains pins or sockets. Master key stays fixed, minor keys rotate. Inserts are not rotated in conjunction with the master key/keyway.

#### RECEPTACLE (front face shown)



#### PLUG (front face shown)



Shell Size	Key & Keyway Arrangement Identification Letter	AR° or AP° BSC	BR° or BP° BSC	CR° or CP° BSC	DR° or DP° BSC
A (9)	N*	105	140	215	265
	A	102	132	248	320
	B	80	118	230	312
	C	35	140	205	275
	D	64	155	234	304
B (11) C (13) D (15)	N*	95	141	208	236
	A	113	156	182	292
	B	90	145	195	252
	C	53	156	220	255
	D	119	146	176	298
E (17) F (19)	N*	80	142	196	293
	A	135	170	200	310
	B	49	169	200	244
	C	66	140	200	257
	D	62	145	180	280
G (21) H (23) J (25)	N*	80	142	196	293
	A	135	170	200	310
	B	49	169	200	244
	C	66	140	200	257
	D	62	145	180	280
	E	79	153	197	272

# MIL-DTL-38999, Series III TV

## How to Order (Commercial)

38999

### 1. SELECT A TYPE & CLASS

1.	2.	3.	4.	5.	** If Required
Type & Class	Shell Size-Insert Arrg.	Contact Type	Alternate Position	PCB Length**	
TVPS00RB-					

	ALUMINUM						
	Electroless Nickel	Olive Drab Cadmium	Durmalon	Black Zinc	Electroless Nickel (With Ground Plane)	Olive Drab Cadmium (With Ground Plane)	Marine Bronze
Temperature	200°C	175°C	175°C	175°C	200°C	175°C	200°C
Salt Spray	48 Hrs	500 Hrs	500 Hrs	500 Hrs	48 Hrs	500 Hrs	2,000 Hrs
EMI Shielding	-65dB @ 10GHz	-65dB @ 10GHz	-50dB @ 10GHz	-50dB @ 10GHz	-65dB @ 10GHz	-65dB @ 10GHz	-65dB @ 10GHz
RoHS							

RATES

Receptacle	Wall Mounting Receptacle	TVPS00RF-	TVP00RW-	TVP00DT-	TVP00DZ-	TVP00RGF-	TVP00RGW-	TVPS00RB-
	Box Mounting Receptacle	TVPS02RF-	TVP02RW-	TVP02DT-	TVP02DZ-	TVP02RGF-	TVP02RGW-	TVPS02RB-
	Line Receptacle	TVS01RF-	TV01RW-	TV01DT-	TV01DZ-	TV01RGF-	TV01RGW-	TVS01RB-
	Jam Nut Receptacle	TVS07RF-	TV07RW-	TV07DT-	TV07DZ-	TV07RGF-	TV07RGW-	TVS07RB-

CONNECTOR TYPE & STYLE

Plugs	Straight Plug	TVS06RF-	TV06RW-	TV06DT-	TV06DZ-	TV06RGF-	TV06RGW-	TVS06RB-
	Flange Mounted Plug	TVS09RF-	TV09RW-	TV09DT-	TV09DZ-	TV09RGF-	TV09RGW-	TVS09RB-
	Straight Plug w Dualok	TVS56RF-	TV56RW-	TV56DT-	TV56DZ-	TV56RGF-	TV56RGW-	TVS56RB-
	Straight Plug w Clutch-Lok*	-	-	-	-	-	-	-

\* Stamped with Mil-Spec #D38999

Printed Circuit Board	Wall Mounting Receptacle	TVPS00RF-	TVP00RW-	TVP00DT-	TVP00DZ-	-	-	TVPS00RB-
	Box Mounting Receptacle	TVPS02RF-	TVP02RW-	TVP02DT-	TVP02DZ-	-	-	TVPS02RB-
	Jam Nut	TVS07RF-	TV07RW-	TV07DT-	TV07DZ-	-	-	TVS07RB-
	Wall Mount (Double Flange)	TVPS40RF-	TVP40RW-	TVP40DT-	TVP40DZ-	-	-	TVPS40RB-
	Jam Nut (Double Flange)	TVS47RF-	TV47RW-	TV47DT-	TV47DZ-	-	-	TVS47RB-
	Wall Mount (Clinch Nuts)	TVPS10RF-	TVP10RW-	TVP10DT-	TVP10DZ-	-	-	TVPS10RB-
	Box Mount (Clinch Nuts)	TVPS12RF-	TVP12RW-	TVP12DT-	TVP12DZ-	-	-	TVPS12RB-

Hermetic	Box Mounting Receptacle	Hermetic only available in Stainless Steel
	Jam Nut Receptacle	
	Solder Mount	
	Wall Mounting Receptacle	

Insert arrangements using multi-axial (i.e. coax, twinax, triax shielded) contacts should not be used in firewall applications.

\*Coaxial arrangements are not available in firewall classes.



A

# MIL-DTL-38999, Series III TV

## How to Order (Commercial)

COMPOSITE				STAINLESS STEEL			
Electroless Nickel	Olive Drab Cadmium	Electroless Nickel (With Ground Plane)	Olive Drab Cadmium (With Ground Plane)	Passivated (Firewall)	Passivated (Non-Firewall)	Nickel Plated (Firewall)	Nickel Plated (Non-Firewall)
200°C	175°C	200°C	175°C	200°C	200°C	200°C	200°C
2,000 Hrs	2,000 Hrs	2,000 Hrs	2,000 Hrs	500 Hrs	500 Hrs	500 Hrs	500 Hrs
-65dB @ 10GHz	-65dB @ 10GHz	-65dB @ 10GHz	-65dB @ 10GHz	-65dB @ 10GHz	-65dB @ 10GHz	-65dB @ 10GHz	-50dB @ 10GHz

CTVPS00RF-	CTVP00RW-	CTVP00RGF-	CTVP00RGW-	TVPS00RK-	TVPS00RKN-	TVPS00RS-	TVPS00RL-
CTVPS02RF-	CTVP02RW-	CTVP02RGF-	CTVP02RGW-	TVPS02RK-	TVPS02RKN-	TVPS02RS-	TVPS02RL-
CTVS01RF-	CTV01RW-	CTV01RGF-	CTV01RGW-	TVS01RK-	TVS01RKN-	TVS01RS-	TVS01RL-
CTVS07RF-	CTV07RW-	CTV07RGF-	CTV07RGW-	TVS07RK-	TVS07RKN-	TVS07RS-	TVS07RL-

CTVS06RF-	CTV06RW-	CTV06RGF-	CTV06RGW-	TVS06RK-	TVS06RKN-	TVS06RS-	TVS06RL-
CTVS09RF-	CTV09RW-	CTV09RGF-	CTV09RGW-	TVS09RK-	TVS09RKN-	TVS09RS-	TVS09RL-
CTVS56RF-	CTV56RW-	CTV56RGF-	CTV56RGW-	TVS56RK-	TVS56RKN-	TVS56RS-	TVS56RL-
-	-	-	-	MTVS26RK-	-	-	-

				TVPS00RK-	TVPS00RKN-	TVPS00RS-	TVPS00RL-
				TVPS02RK-	TVPS02RKN-	TVPS02RS-	TVPS02RL-
				TVS07RK-	TVS07RKN-	TVS07RS-	TVS07RL-
				TVPS40RK-	TVPS40RKN-	TVPS40RS-	TVPS40RL-
				TVS47RK-	TVS47RKN-	TVS47RS-	TVS47RL-
				TVPS10RK-	TVPS10RKN-	TVPS10RS-	TVPS10RL-
				TVPS12RK-	TVPS12RKN-	TVPS12RS-	TVPS12RL-

Hermetic only available in Stainless Steel	-	TVPS02Y-	-	TVPS02YN-
	-	TVS07Y-	-	TVS07YN-
	-	TVSIY-	-	TVSIYN-
	-	TVSHIY-	-	TVSHIYN-

1. Type & Class	2. Shell Size-Insert Arrg.	3. Contact Type	4. Alternate Position	5. PCB Length**	** If Required
	11-4	P			

## 2. SELECT A SHELL SIZE & INSERT ARRANGEMENT SEE PAGES 2-5

Shell Size & Insert Arrangements are on pages 2-5. First number represents Shell Size, second number is the Insert Arrangement.

\* Size 7 and 7H are Double Start Threads only

## 3. CONTACT TYPE

<b>P</b>	500 Cycle Pin Contacts, if require Less Contacts place (LC) at the end of part number
<b>S</b>	500 Cycle Socket Contacts, if require Less Contacts place (LC) at the end of part number
<b>H</b>	1500 Cycle Pin Contacts
<b>J</b>	1500 Cycle Socket Contacts
<b>X</b>	Eyelet contacts, hermetics only

# MIL-DTL-38999, Series III TV

## How to Order (Alternate Keying) Commercial

38999

### 4. SELECT A ALTERNATE KEYING COMMERCIAL

1.	2.	3.	4.	5.
Type & Class	Shell Size- Insert Arrg.	Contact Type	Alternate Position	PCB Length**
			N	

Shell Size	Key & Keyway Arrangement Identification Letter	AR° or AP° BSC	BR° or BP° BSC	CR° or CP° BSC	DR° or DP° BSC
7, 7H	N*	120	240		
	A	132	248		
	B	80	230	NA	NA
	C	140	275		
	D	155	234		
9	N*	105	140	215	265
	A	102	132	248	320
	B	80	118	230	312
	C	35	140	205	275
	D	64	155	234	304
11, 13, and 15	N*	95	141	208	236
	A	113	156	182	292
	B	90	145	195	252
	C	53	156	220	255
	D	119	146	176	298
17 and 19	N*	80	142	196	293
	A	135	170	200	310
	B	49	169	200	244
	C	66	140	200	257
	D	62	145	180	280
21, 23, and 25	N*	80	142	196	293
	A	135	170	200	310
	B	49	169	200	244
	C	66	140	200	257
	D	62	145	180	280
25L, 33, and 37	N*	80	142	188	293
	A	135	170	188	310
	B	49	169	188	244
	C	66	140	188	257
	D	62	145	188	280

\* An "N" designation is used on D38999 military part number but not on the commercial versions

### KEY/KEYWAY POSITION

A plug with a given rotation letter will mate with a receptacle with the same rotation letter. The angles for a given connector are the same whether it contains pins or sockets. Master key stays fixed, minor keys rotate. Inserts are not rotated in conjunction with the master key/keyway.

### RECEPTACLE (FRONT FACE SHOWN)



### PLUG (FRONT FACE SHOWN)



### Alignment Disc



Shell Size	D Dia. ±.010
9	.234
11	.350
13	.500
15	.725
17	.750
19	.850
21	.953
23	1.147
25	1.250

### 5. PCB LENGTH FOR COMMERCIAL ONLY

Contact Stickout	Pin Contacts	Pin Contacts with Alignment Disk	** If Required
.150"	(P15)	(P15AD)	
.250"	(P25)	(P25AD)	
.350"	(P35)	(P35AD)	

Contact Stickout	Socket Contacts	Socket Contacts with Alignment Disk
.150"	(S15)	(S15AD)
.250"	(S25)	(S25AD)
.350"	(S35)	(S35AD)

### 5. PCB LENGTH FOR HD38999 ONLY

9-9, 11-19, 13-32, 15-55, 17-73, 19-88, 21-121, 23-151, 25-187

PCB tail stickout +/- .040 inch	Without Alignment Disk		With Alignment Disk	
	Pins	Sockets	Pins	Sockets
.100" nominal	(P1*)	(S1)	(P1AD)	(S1AD)
.150" nominal	(P15*)	(S15)	(P15AD)	(S15AD)
.200" nominal	(P2)	(S2)	(P2AD)	(S2AD)
.250" nominal	(P25*)	(S25)	(P25AD)	(S25AD)
.300" nominal	(P3*)	(S3)	(P3AD)	(S3AD)
.350" nominal	(P35)	(S35)	(P35AD)	(S35AD)

\* Not available in TV40 wall mount double flange receptacle or TV47 jam nut double flange receptacle styles.

Note: Standard tail diameter is 0.019±.001 Stick out is measured from the end of the connector shell to end of the contact

Series III

### HOW TO ORDER - BOEING BACC63 CT & CU

1.	2.	3.	4.	5.	6.	7.	8.
Boeing Basic Number	Style	Shell Size	Shell Finish & Contact	Insert Arrangement	Contact Type	Alternate Keying Position	Ordering Option
BACC63	CT	15	–	19	P	N	H

### COMPOSITE

1. BOEING NUMBER	
BACC63	Boeing

2. STYLE	
CT	Composite Plug
CU	Composite Receptacle

3. SHELL SIZE	
15	One Shell Size

4. SHELL FINISH & CONTACT	
C	CT Style Only. Cadmium Plated, Grounded
D	Cadmium Plated, ungrounded
G	Nickel Plated, Grounded
–	Nickel Plated, Ungrounded

**5. INSERT ARRANGEMENTS-**  
Consult Amphenol Aerospace for insert arrangements available.

6. CONTACT TYPE	
P	Pin
S	Socket

7. ALTERNATE KEYING POSITION	
N	Normal
A-E	Alternates

8. ORDERING OPTIONS	
H	Without Contacts & Seal Plugs
Blank	With Contacts & Seal Plugs

### HOW TO ORDER - BOEING BACC63 DB & DC

1.	2.	3.	4.	5.	6.
Boeing Basic Number	Style	Shell Size-Insert Arrangement	Contact Type	Alternate Keying Position	Ordering Option
BACC63	DB	15-19	P	N	H
BACC63	DC	17-8	P	N	H

### STAINLESS STEEL

1. BOEING NUMBER	
BACC63	Boeing

2. SELECT A STYLE	
DB	Stainless Steel Plug
DC	Stainless Steel Receptacle

4. CONTACT TYPE	
P	Pin
S	Socket

5. ALTERNATE KEYING POSITION	
N	Normal
A-E	Alternates

6. ORDERING OPTION	
H	Without Contacts & Seal Plugs
Blank	With Contacts & Seal Plugs

### 3. SELECT A SHELL SIZE & INSERT ARRANGEMENT SEE PAGES 2-5

Shell Size & Insert Arrangements are on pages 2-5. First number represents Shell Size, second number is the Insert Arrangement. Please include the dash.

- III
- II
- I
- SJT
- Access
- Aquacon

# Wall Mounting Receptacle

Military (D38999/20), Commercial (TVP00, TVPS00, CTVP00, CTVPS00)

38999

PART NUMBER BUILDER Page 42-46  
ONLINE CONFIGURATOR [www.amphenol-aerospace.com](http://www.amphenol-aerospace.com)

MILITARY  
D38999/20

Commercial

ALUMINUM  
TVPS00RF  
TVP00RW  
TVP00DT  
TVP00DZ  
TVP00RGF  
TVP00RGW  
TVPS00RB

COMPOSITE  
CTVPS00RF  
CTVP00RW  
CTVP00RGF  
CTVP00RGW

STAINLESS STEEL  
TVPS00RK  
TVPS00RKN  
TVPS00RS  
TVPS00RL



VIEW D  
FOR SIZE 8 COAXIAL ONLY,  
RELATIVE TO -A-



PANEL HOLE  
DIMENSIONS



BACK PANEL  
MOUNTING



FRONT PANEL  
MOUNTING

VIEW D  
FOR SIZE 8 TWINAX ONLY,  
RELATIVE TO -A-



† Red band indicates fully mated  
†† Blue band indicates rear release contact retention system

Inches

Shell Size	MS Shell Size Code	B Thread Class 2A 0.1P=0.3L-TS (Plated)	L Max. (TV)	L' Max. (CTV)	M +.000 - .005 (TV)	M' +.000 - .005 (CTV)	R <sup>1</sup>	R <sup>2</sup>	S Max.	T ±.008	Z Max. (TV)	Z' Max. (CTV)	A <sup>1</sup> Back Panel Mount	A <sup>2</sup> Front Panel Mount	AA Max. Panel Thickness	LL +.006 - .000 (TV)	LL1 ±.005 (CTV)	TT ±.008
9	A	.6250	.469	.514	.820	.773	.719	.594	.948	.128	.153	.198	.655	.516	.234	.905	.908	.216
11	B	.7500	.469	.514	.820	.773	.812	.719	1.043	.128	.153	.198	.796	.625	.234	.905	.908	.194
13	C	.8750	.469	.514	.820	.773	.906	.812	1.137	.128	.153	.198	.922	.750	.234	.905	.908	.194
15	D	1.0000	.469	.514	.820	.773	.969	.906	1.232	.128	.153	.198	1.047	.906	.234	.905	.908	.173
17	E	1.1875	.469	.514	.820	.773	1.062	.969	1.323	.128	.153	.198	1.219	1.016	.234	.905	.908	.194
19	F	1.2500	.469	.514	.820	.773	1.156	1.062	1.449	.128	.153	.198	1.297	1.141	.234	.905	.908	.194
21	G	1.3750	.500	.545	.790	.741	1.250	1.156	1.575	.128	.183	.228	1.442	1.266	.204	.905	.904	.194
23	H	1.5000	.500	.545	.790	.741	1.375	1.250	1.701	.154	.183	.228	1.547	1.375	.204	.905	.904	.242
25	J	1.6250	.500	.545	.790	.741	1.500	1.375	1.823	.154	.183	.228	1.672	1.484	.204	.905	.904	.242

Millimeters

Shell Size	MS Shell Size Code	L Max. (TV)	L' Max. (CTV)	M +.00 - .13 (TV)	M' +.00 - .13 (CTV)	R <sup>1</sup>	R <sup>2</sup>	S Max.	T ±.20	V Thread Metric	Z Max. (TV)	Z' Max. (CTV)	A <sup>1</sup> Back Panel Mount	A <sup>2</sup> Front Panel Mount	AA Max.	LL +.15 - .00 (TV)	LL1 ±.13 (CTV)	TT ±.20
9	A	11.91	13.06	20.83	19.63	18.26	15.09	24.1	3.25	M12X1-6g	3.89	5.03	16.66	13.11	5.94	22.99	23.06	5.49
11	B	11.91	13.06	20.83	19.63	20.62	18.26	26.5	3.25	M15X1-6g	3.89	5.03	20.22	15.88	5.94	22.99	23.06	4.93
13	C	11.91	13.06	20.83	19.63	23.01	20.62	28.9	3.25	M18X1-6g	3.89	5.03	23.42	19.05	5.94	22.99	23.06	4.93
15	D	11.91	13.06	20.83	19.63	24.61	23.01	31.3	3.25	M22X1-6g	3.89	5.03	26.59	23.01	5.94	22.99	23.06	4.39
17	E	11.91	13.06	20.83	19.63	26.97	24.61	33.7	3.25	M25X1-6g	3.89	5.03	30.96	25.81	5.94	22.99	23.06	4.93
19	F	11.91	13.06	20.83	19.63	29.36	26.97	36.9	3.25	M28X1-6g	3.89	5.03	32.94	28.98	5.94	22.99	23.06	4.93
21	G	12.70	13.84	20.07	18.82	31.75	29.36	40.1	3.25	M31X1-6g	4.65	5.79	36.12	32.16	5.18	22.99	22.96	4.93
23	H	12.70	13.84	20.07	18.82	34.93	31.75	43.3	3.91	M34X1-6g	4.65	5.79	39.29	34.93	5.18	22.99	22.96	6.15
25	J	12.70	13.84	20.07	18.82	38.10	34.93	46.4	3.91	M37X1-6g	4.65	5.79	42.47	37.69	5.18	22.99	22.96	6.15

All dimensions for reference only  Designates true position dimensioning



# Box Mounting Receptacle

## Commercial (TVP02, TVPS02, CTVP02, CTVPS02)

PART NUMBER BUILDER Page 44-46  
ONLINE CONFIGURATOR [www.amphenol-aerospace.com](http://www.amphenol-aerospace.com)

<b>Commercial</b>	<b>ALUMINUM</b>	<b>COMPOSITE</b>	<b>STAINLESS STEEL</b>
	TVPS02RF	CTVPS02RF	TVPS02RK
	TVP02RW	CTVP02RW	TVPS02RKN
	TVP02DT	CTVP02RGF	TVPS02RS
	TVP02DZ	CTVP02RGW	TVPS02RL
	TVP02RGF		
	TVP02RGW		



38999

III
II
I
SJT
Access
Aquacon



### PANEL HOLE DIMENSIONS



### BACK PANEL MOUNTING



### FRONT PANEL MOUNTING

† Red band indicates fully mated  
†† Blue band indicates rear release contact retention system

Consult Amphenol Aerospace for availability of composite box mount receptacles.

Inches

Shell Size	MS Shell Size Code	B Thread Class 2A 0.1P=0.3L-TS (Plated)	L Max. (TV)	L1 Max. (CTV)	M +.000 - .005 (TV)	M1 +.000 - .005 (CTV)	R1	R2	S Max.	T ±.008	Z Max. (TV)	Z1 Max. (CTV)	A1 Back Panel Mount	A2 Front Panel Mount	AA Max. Panel Thickness	LL +.006 - .000 (TV)	LL1 ±.005 (CTV)	TT ±.008
9	A	.6250	.205	.250	.820	.773	.719	.594	.948	.128	.153	.198	.650	.510	.234	.905	.908	.216
11	B	.7500	.205	.250	.820	.773	.812	.719	1.043	.128	.153	.198	.800	.620	.234	.905	.908	.194
13	C	.8750	.205	.250	.820	.773	.906	.812	1.137	.128	.153	.198	.910	.740	.234	.905	.908	.194
15	D	1.0000	.205	.250	.820	.773	.969	.906	1.232	.128	.153	.198	1.040	.900	.234	.905	.908	.173
17	E	1.1875	.205	.250	.820	.773	1.062	.969	1.323	.128	.153	.198	1.210	1.010	.234	.905	.908	.194
19	F	1.2500	.205	.250	.820	.773	1.156	1.062	1.449	.128	.153	.198	1.280	1.130	.234	.905	.908	.194
21	G	1.3750	.235	.280	.790	.741	1.250	1.156	1.575	.128	.183	.228	1.410	1.250	.204	.905	.904	.194
23	H	1.5000	.235	.280	.790	.741	1.375	1.250	1.701	.154	.183	.228	1.530	1.360	.204	.905	.904	.242
25	J	1.6250	.235	.280	.790	.741	1.500	1.375	1.823	.154	.183	.228	1.660	1.470	.204	.905	.904	.242

Millimeters

Shell Size	MS Shell Size Code	L Max. (TV)	L1 Max. (CTV)	M +.00 - .13 (TV)	M1 +.00 - .13 (CTV)	R1	R2	S Max.	T ±.20	Z Max. (TV)	Z1 Max. (CTV)	A1 Back Panel Mount	A2 Front Panel Mount	AA Max.	LL +.15 - .00 (TV)	LL1 ±.13 (CTV)	TT ±.20
9	A	5.21	6.35	20.83	19.63	18.26	15.09	24.1	3.25	3.89	5.03	16.66	13.11	5.94	22.99	23.06	5.49
11	B	5.21	6.35	20.83	19.63	20.62	18.26	26.5	3.25	3.89	5.03	20.22	15.88	5.94	22.99	23.06	4.93
13	C	5.21	6.35	20.83	19.63	23.01	20.62	28.9	3.25	3.89	5.03	23.42	19.05	5.94	22.99	23.06	4.93
15	D	5.21	6.35	20.83	19.63	24.61	23.01	31.3	3.25	3.89	5.03	26.59	23.01	5.94	22.99	23.06	4.39
17	E	5.21	6.35	20.83	19.63	26.97	24.61	33.7	3.25	3.89	5.03	30.96	25.81	5.94	22.99	23.06	4.93
19	F	5.21	6.35	20.83	19.63	29.36	26.97	36.9	3.25	3.89	5.03	32.94	28.98	5.94	22.99	23.06	4.93
21	G	5.97	7.11	20.07	18.82	31.75	29.36	40.1	3.25	4.65	5.79	36.12	32.16	5.18	22.99	22.96	4.93
23	H	5.97	7.11	20.07	18.82	34.92	31.75	43.3	3.91	4.65	5.79	39.29	34.93	5.18	22.99	22.96	6.15
25	J	5.97	7.11	20.07	18.82	38.10	34.92	46.4	3.91	4.65	5.79	42.47	37.69	5.18	22.99	22.96	6.15

All dimensions for reference only

Designates true position dimensioning

# Line Receptacle

## Commercial (TV01, TVS01, CTV01, CTVS01)

PART NUMBER BUILDER Page 44-46  
 ONLINE CONFIGURATOR [www.amphenol-aerospace.com](http://www.amphenol-aerospace.com)



Commercial	ALUMINUM	COMPOSITE	STAINLESS STEEL
	TVS01RF	CTVS01RF	TVS01RK
	TV01RW	CTV01RW	TVS01RKN
	TV01DT	CTV01RGF	TVS01RS
	TV01DZ	CTV01RGW	TVS01RL
	TV01RGF		
	TV01RGW		
	TVS01RB		



† Red band indicates fully mated  
 †† Blue band indicates rear release contact retention system

VIEW D  
 FOR SIZE 8 COAXIAL ONLY,  
 RELATIVE TO -A-



VIEW D  
 FOR SIZE 8 TWINAX ONLY,  
 RELATIVE TO -A-



Inches

Shell Size	MS Shell Size Code	B Thread 0.1P-0.3L-TS-2A (Plated)	M +.000 -0.005 (TV)	M' +.000 -0.005 (CTV)	L Max. (TV)	L' Max. (CTV)	S ±.010 (TV)	S' ±.010 (CTV)	Z Max (TV)	Z' Max (CTV)	GG ±.010 (TV)	GG' ±.010 (CTV)	LL +.006 -0.000 (TV)	LL' ±.005 (CTV)
9	A	.6250	.820	.773	.469	.514	.675	.635	.153	.198	.812	.699	.905	.908
11	B	.7500	.820	.773	.469	.514	.800	.765	.153	.198	.905	.875	.905	.908
13	C	.8750	.820	.773	.469	.514	.925	.885	.153	.198	1.093	1.007	.905	.908
15	D	1.0000	.820	.773	.469	.514	1.050	1.100	.153	.198	1.219	1.140	.905	.908
17	E	1.1875	.820	.773	.469	.514	1.238	1.197	.153	.198	1.375	1.229	.905	.908
19	F	1.2500	.820	.773	.469	.514	1.300	1.260	.153	.198	1.469	1.380	.905	.908
21	G	1.3750	.790	.741	.500	.545	1.425	1.385	.183	.228	1.625	1.493	.905	.904
23	H	1.5000	.790	.741	.500	.545	1.550	1.510	.183	.228	1.750	1.626	.905	.904
25	J	1.6250	.790	.741	.500	.545	1.675	1.635	.183	.228	1.875	1.777	.905	.904

Millimeters

Shell Size	MS Shell Size Code	M +.00 -0.13 (TV)	M1 +.00 -0.13 (CTV)	L Max. (TV)	L1 Max. (CTV)	S ±.25 (TV)	S1 ±.010 (CTV)	V Thread Metric	Z Max (TV)	Z1 Max (CTV)	GG ±.25 (TV)	GG1 ±.25 (CTV)	LL +.15 -0.00 (TV)	LL1 ±.13 (CTV)
9	A	20.83	19.63	11.91	13.06	17.15	16.13	M12X1-6g	3.89	5.03	20.62	17.75	22.99	23.06
11	B	20.83	19.63	11.91	13.06	20.32	19.43	M15X1-6g	3.89	5.03	22.99	22.22	22.99	23.06
13	C	20.83	19.63	11.91	13.06	23.50	22.47	M18X1-6g	3.89	5.03	27.76	25.57	22.99	23.06
15	D	20.83	19.63	11.91	13.06	26.67	27.94	M22X1-6g	3.89	5.03	30.96	28.95	22.99	23.06
17	E	20.83	19.63	11.91	13.06	31.45	30.40	M25X1-6g	3.89	5.03	34.93	31.21	22.99	23.06
19	F	20.83	19.63	11.91	13.06	33.02	32.00	M28X1-6g	3.89	5.03	37.31	35.05	22.99	23.06
21	G	20.07	18.82	12.70	13.84	36.20	35.18	M31X1-6g	4.65	5.79	41.28	37.92	22.99	22.96
23	H	20.07	18.82	12.70	13.84	39.37	38.35	M34X1-6g	4.65	5.79	44.45	41.30	22.99	22.96
25	J	20.07	18.82	12.70	13.84	42.55	41.53	M37X1-6g	4.65	5.79	47.63	45.13	22.99	22.96

All dimensions for reference only

# Jam Nut Receptacle

## Military (D38999/24), Commercial (TV07, TVS07, CTV07, CTVP07)

PART NUMBER BUILDER Page 42-46

ONLINE CONFIGURATOR [www.amphenol-aerospace.com](http://www.amphenol-aerospace.com)

**MILITARY**  
D38999/24

**Commercial**

**ALUMINUM**  
TVS07RF  
TV07RW  
TV07DT  
TV07DZ  
TV07RGF  
TV07RGW  
TVS07RB

**COMPOSITE**  
CTVPS07RF  
CTV07RW  
CTV07RGF  
CTV07RGW

**STAINLESS STEEL**  
TVS07RK  
TVS07RKN  
TVS07RS  
TVS07RL



38999

- III
- II
- I
- SJT
- Access
- Aquacon

**Series III**



- † Red band indicates fully mated
  - †† Blue band indicates rear release contact retention system
  - ★ .059 dia min.
- 1.5 dia min., 3 lockwire holes Formed lockwire hole design (6 holes) is optional

Inches

Shell Size	MS Shell Size Code	B Thread Class 2A 0.1P-0.3L-TS (Plated)	C Max.	D <sup>1</sup> +.010 -0.000	D <sup>2</sup> +.000 -0.010	H Hex +.017 -0.016	S ±.010
9	A	.6250	1.199	.693	.657	.875	1.062
11	B	.7500	1.386	.825	.770	1.000	1.250
13	C	.8750	1.511	1.010	.955	1.188	1.375
15	D	1.0000	1.636	1.135	1.085	1.312	1.500
17	E	1.1875	1.761	1.260	1.210	1.438	1.625
19	F	1.2500	1.949	1.385	1.335	1.562	1.812
21	G	1.3750	2.073	1.510	1.460	1.688	1.938
23	H	1.5000	2.199	1.635	1.585	1.812	2.062
25	J	1.6250	2.323	1.760	1.710	2.000	2.188

Millimeters

Shell Size	MS Shell Size Code	C Max.	D <sup>1</sup> +.25 -0.00	D <sup>2</sup> +.00 -0.25	H Hex +.43 -0.41	S ±.25	V Thread Metric
9	A	30.45	17.60	16.70	22.23	26.97	M12X1-6g
11	B	35.20	20.96	19.59	25.40	31.75	M15X1-6g
13	C	38.38	25.65	24.26	30.18	34.93	M18X1-6g
15	D	41.55	28.83	27.56	33.32	38.10	M22X1-6g
17	E	44.73	32.01	30.73	36.53	41.28	M25X1-6g
19	F	49.50	35.18	33.91	39.67	46.02	M28X1-6g
21	G	52.65	38.35	37.08	42.80	49.23	M31X1-6g
23	H	55.85	41.53	40.26	46.02	52.37	M34X1-6g
25	J	59.00	44.70	43.43	50.80	55.58	M37X1-6g

All dimensions for reference only NOTE: Deep reach receptacles are available for panel thicknesses up to .750 max.

# Straight Plug

## Military (D38999/26), Commercial (TV06, TVS06, CTV06, CTVS06)

38999

PART NUMBER BUILDER Page 42-46  
 ONLINE CONFIGURATOR [www.amphenol-aerospace.com](http://www.amphenol-aerospace.com)

**MILITARY**  
 D38999/26

Commercial

**ALUMINUM**  
 TVS06RF  
 TV06RW  
 TV06DT  
 TV06DZ  
 TV06RGF  
 TV06RGW  
 TVS06RB

**COMPOSITE**  
 CTVS06RF  
 CTV06RW  
 CTV06RGF  
 CTV06RGW

**STAINLESS STEEL**  
 TVS06RK  
 TVS06RKN  
 TVS06RS  
 TVS06RL



VIEW D  
 FOR SIZE 8 COAXIAL ONLY,  
 RELATIVE TO -A-



COMPOSITE



VIEW D  
 FOR SIZE 8 TWINAX ONLY,  
 RELATIVE TO -A-



† Blue band indicates rear release contact retention system

Shell Size	MS Shell Size Code	B Thread 0.1P-0.3L-TS-2B (Plated)	Q Dia. Max.
9	A	.6250	.858
11	B	.7500	.984
13	C	.8750	1.157
15	D	1.0000	1.280
17	E	1.1875	1.406
19	F	1.2500	1.516
21	G	1.3750	1.642
23	H	1.5000	1.768
25	J	1.6250	1.890

All dimensions for reference only.

Shell Size	MS Shell Size Code	Q Max.	V Thread Metric
9	A	21.8	M12X1-6g
11	B	25.0	M15X1-6g
13	C	29.4	M18X1-6g
15	D	32.5	M22X1-6g
17	E	35.7	M25X1-6g
19	F	38.5	M28X1-6g
21	G	41.7	M31X1-6g
23	H	44.9	M34X1-6g
25	J	48.0	M37X1-6g

Series III

A

# Flange Mounting Plug

## Commercial (TV09, TVS09, CTV09, CTVPS09)

PART NUMBER BUILDER Page 44-46  
ONLINE CONFIGURATOR [www.amphenol-aerospace.com](http://www.amphenol-aerospace.com)

<b>Commercial</b>	<b>ALUMINUM</b>	<b>COMPOSITE</b>	<b>STAINLESS STEEL</b>
	TVS09RF	CTVPS09RF	TVS09RK
	TV09RW	CTV09RW	TVS09RKN
	TV09DT	CTV09RGF	TVS09RS
	TV09DZ	CTV09RGW	TVS09RL
	TV09RGF		
	TV09RGW		
	TVS09RB		



38999

- III
- II
- I
- SJT
- Access
- Aquacon

**Series III**



Shell Size	MS Shell Size Coded	B Thread 0.1P-0.3L-TS-2A (Plated)	G ±.060	Q Dia. Max	R	GG Dia ±.005
9**	A	.6250	1.106	.859	1.038	1.838
11	B	.7500	1.106	.969	1.115	1.948
13**	C	.8750	1.106	1.141	1.240	2.124
15	D	1.0000	1.106	1.266	1.327	2.248
17	E	1.1875	1.106	1.391	1.417	2.375
19	F	1.2500	1.356	1.500	1.557	2.495
21	G	1.3750	1.356	1.625	1.624	2.568
23	H	1.5000	1.356	1.750	1.713	2.723
25	J	1.6250	1.356	1.875	1.801	2.848

Millimeters

Shell Size	MS Shell Size Coded	G ±1.52	Q Dia. Max	R	GG Dia ±.13
9**	A	28.09	21.82	26.37	46.69
11	B	28.09	24.62	28.32	49.48
13**	C	28.09	28.98	31.50	53.95
15	D	28.09	32.16	33.71	57.10
17	E	28.09	35.33	35.99	60.33
19	F	34.44	38.10	39.55	63.37
21	G	34.44	41.28	41.25	65.23
23	H	34.44	44.45	43.51	69.16
25	J	34.44	47.63	45.75	72.34

All dimensions for reference only

☐ Designates true position dimensioning

\*\* Partially tooled. Consult Amphenol Aerospace for availability

# High Vibration Dualok Connector 38999 Series III Type

## Commercial Plug (TV56, TVS56, CTV56, CTVS56)

38999

PART NUMBER BUILDER Page 44-46  
 ONLINE CONFIGURATOR [www.amphenol-aerospace.com](http://www.amphenol-aerospace.com)

Commercial	ALUMINUM	COMPOSITE	STAINLESS STEEL
	TVS56RF	CTVS56RF	TVS56RK
	TV56RW	CTV56RW	TVS56RKN
	TV56DT	CTV56RGF	TVS56RS
	TV56DZ	CTV56RGW	TVS56RL
	TV56RGF		
	TV56RGW		
	TVS56RB		

Dualok



Shell Size	B Thread 0.1-0.3L-TS-2B (Plated)	E Dia. Max.	Q Dia. Max. Metric	V Thread Metric.
9	.6250	.953	24.2	M12X1-6g
11	.7500	1.053	26.7	M15X1-6g
13	.8750	1.252	31.8	M18X1-6g
15	1.0000	1.365	34.6	M22X1-6g
19	1.2500	1.605	40.7	M28X1-6g
21	1.3750	1.735	44.0	M31X1-6g
25	1.6250	1.975	50.1	M37X1-6g

A

# Clutch-Lok™ Plug

## Commercial (26)

Designed for high vibration and harsh environments such as aircraft gas turbine engines, the CLUTCH-LOK is also an ideal choice for demanding applications such as aircraft, space and military ground vehicles. The unique clutch design of the Amphenol CLUTCH-LOK means that you don't have to compromise the need for quick, smooth mating of plugs and receptacles in order to get increased uncoupling torque.

The CLUTCH-LOK has proven to not only remain mated and pass all the Series III specification requirements, it also has proven to actually tighten itself under vibration. This is a powerful advantage over the traditionally high vibration application connectors. The CLUTCH-LOK is also a tremendous advantage in inaccessible, hard to reach areas where mating torque is difficult to apply and complete coupling is not verifiable by inspection.

### CLUTCH-LOK FEATURES AND BENEFITS:

- High degree of differential torque
- Infinite free coupling and positive metal-to-metal bottoming with each mating
- No settling back to the next ratchet tooth
- Available with stainless steel shells and Class K firewall inserts
- All the advantages of MIL-DTL-38999 Series III including EMI/RFI shielding, electrolytic erosion resistance and contact protection with recessed pins
- Enhanced connector performance at affordable prices
- Completely intermateable with all existing MIL-DTL-38999 Series III connectors
- Fully QPL'd

PART NUMBER BUILDER Page 44-46  
ONLINE CONFIGURATOR [www.amphenol-aerospace.com](http://www.amphenol-aerospace.com)

### STAINLESS STEEL MTV26RK



Inches

Shell Size	MS Shell Size Code	B Thread 0.1P-0.3L-TS-2B (Plated)	Q Dia. Max.
9	A	.6250	.858
11	B	.7500	.984
13	C	.8750	1.157
15	D	1.0000	1.280
17	E	1.1875	1.406
19	F	1.2500	1.516
21	G	1.3750	1.642
23	H	1.5000	1.768
25	J	1.6250	1.890

Millimeters

Shell Size	MS Shell Size Code	Q Max.	V Thread Metric
9	A	21.8	M12X1-6g
11	B	25.0	M15X1-6g
13	C	29.4	M18X1-6g
15	D	32.5	M22X1-6g
17	E	35.7	M25X1-6g
19	F	38.5	M28X1-6g
21	G	41.7	M31X1-6g
23	H	44.9	M34X1-6g
25	J	48.0	M37X1-6g

All dimensions for reference only.

# PCB Wall Mounting Receptacle (Back Panel Mounting)

## Commercial (TVP00 & TVPS00)

38999

PART NUMBER BUILDER Page 44-46  
 ONLINE CONFIGURATOR [www.amphenol-aerospace.com](http://www.amphenol-aerospace.com)

Commercial	ALUMINUM	STAINLESS STEEL
	TVPS00RF	TVPS00RK
	TVP00RW	TVPS00RKN
	TVP00DT	TVPS00RS
	TVP00DZ	TVPS00RL
	TVPS00RB	



Shell Size	B Thread Class 2A (Plated) 0.1P-0.3L-TS	L Max. (TV)	L' Max. (CTV)	M +.000 - .005 (TV)	M' +.000 - .005 (CTV)	R1	R2	S Max.	T +.008 - .006	V Thread Metric	AA Max. Panel Thickness	LL +.006 - .000 (TV)	LL' ±.005 (CTV)	TT +.008 - .006
9	.6250	.469	.514	.820	.773	.719	.594	.948	.128	M12X1-6g	.234	.905	.908	.216
11	.7500	.469	.514	.820	.773	.812	.719	1.043	.128	M15X1-6g	.234	.905	.908	.194
13	.8750	.469	.514	.820	.773	.906	.812	1.137	.128	M18X1-6g	.234	.905	.908	.194
15	1.0000	.469	.514	.820	.773	.969	.906	1.232	.128	M22X1-6g	.234	.905	.908	.173
17	1.1875	.469	.514	.820	.773	1.062	.969	1.323	.128	M25X1-6g	.234	.905	.908	.194
19	1.2500	.469	.514	.820	.773	1.156	1.062	1.449	.128	M28X1-6g	.234	.905	.908	.194
21	1.3750	.500	.545	.790	.741	1.250	1.156	1.575	.128	M31X1-6g	.204	.905	.904	.194
23	1.5000	.500	.545	.790	.741	1.375	1.250	1.701	.154	M34X1-6g	.204	.905	.904	.242
25	1.6250	.500	.545	.790	.741	1.500	1.375	1.823	.154	M37X1-6g	.204	.905	.904	.242

All dimensions for reference only.

Most common options are shown; other options are available.

Designates true position dimensioning

A



# PCB Wall Mounting Receptacle (Back Panel Mounting) (With Clinch Nuts) Commercial (TVP10 & TVPS10)

PART NUMBER BUILDER Page 44-46  
ONLINE CONFIGURATOR [www.amphenol-aerospace.com](http://www.amphenol-aerospace.com)

<b>Commercial</b>	<b>ALUMINUM</b>	<b>STAINLESS STEEL</b>
	TVPS10RF	TVPS10RK
	TVP10RW	TVPS10RKN
	TVP10DT	TVPS10RS
	TVP10DZ	TVPS10RL
	TVPS10RB	

III
II
I
SJT
Access
Aquacon

**Series III**



Shell Size	B Thread Class 2A (Plated) 0.1P-0.3L-TS	L Max. (TV)	L' Max. (CTV)	M +.000 - .005 (TV)	M' +.000 - .005 (CTV)	R	S Max.	T Thread	V Thread Metric	AA Max. Panel Thickness	LL +.006 - .000 (TV)	LL' ±.005 (CTV)
9	.6250	.469	.514	.820	.773	.719	1.094	.112-40UNC-3B	M12X1-6g	.234	.905	.908
11	.7500	.469	.514	.820	.773	.812	1.187	.112-40UNC-3B	M15X1-6g	.234	.905	.908
13	.8750	.469	.514	.820	.773	.906	1.281	.112-40UNC-3B	M18X1-6g	.234	.905	.908
15	1.0000	.469	.514	.820	.773	.969	1.344	.112-40UNC-3B	M22X1-6g	.234	.905	.908
17	1.1875	.469	.514	.820	.773	1.062	1.437	.112-40UNC-3B	M25X1-6g	.234	.905	.908
19	1.2500	.469	.514	.820	.773	1.156	1.531	.112-40UNC-3B	M28X1-6g	.234	.905	.908
21	1.3750	.500	.545	.790	.741	1.250	1.625	.112-40UNC-3B	M31X1-6g	.204	.905	.904
23	1.5000	.500	.545	.790	.741	1.375	1.750	.138-32UNC-3B	M34X1-6g	.204	.905	.904
25	1.6250	.500	.545	.790	.741	1.500	1.875	.138-32UNC-3B	M37X1-6g	.204	.905	.904

All dimensions for reference only.

Consult Amphenol for more information on ordering connectors with clinch nuts.  
Most common options are shown; other options are available.

□ Designates true position dimensioning

† Red band indicates fully mated

†† Blue band indicates rear release contact retention system

# PCB Wall Mounting Double Flange Receptacle

## Commercial (TVP40 & TVPS40)

38999

PART NUMBER BUILDER Page 44-46

ONLINE CONFIGURATOR [www.amphenol-aerospace.com](http://www.amphenol-aerospace.com)

Commercial

ALUMINUM  
 TVPS40RF  
 TVP40RW  
 TVP40DT  
 TVP40DZ  
 TVPS40RB

STAINLESS STEEL  
 TVPS40RK  
 TVPS40RKN  
 TVPS40RS  
 TVPS40RL

Series III



(4) CORROSION RESISTANT STEEL  
 SELF-LOCKING CLINCH NUTS  
 .112-40 UNC-3B PER MIL-N-45938/6-4C  
 EXCEPT FOR TV40 SHELL SIZES 23 & 25:  
 .138-32 UNC-3B PER MIL-N-45938/6-6C

(4) CORROSION RESISTANT STEEL  
 .112-40 UNC-3B HELICAL INSERTS

$\text{⊕} \text{⊘} .005 \text{Ⓜ}$

$\text{⊕} \text{⊘} .005 \text{Ⓜ}$

Shell Size	MS Shell Size Code (For Ref.)	A Dia. ±.005 (TV)	A Dia. ±.005 (CTV)	B Thread Class 2A (Plated) 0.1P-0.3L-TS	M +.000 - .005	M' ±.003 (CTV)	R (Panel Mount) (CTV)	R (Panel Mount) (TV)	S Max. (TV)	S Max. (CTV)	AA Max. Panel Thickness	PCB Mounting Dimensions	
												T Dia. (TV) TP	W (CTV) TP
9	A	NA	1.016	.6250	.820	.770	.719	N/A	NA	.949	.234	NA	.532
11	B	1.062	1.148	.7500	.820	.770	.812	.766	1.187	1.042	.234	.850	.601
13	C	1.250	1.250	.8750	.820	.770	.906	.859	1.281	1.136	.234	.994	.703
15	D	1.375	1.375	1.0000	.820	.770	.969	.938	1.344	1.230	.234	1.119	.791
17	E	1.500	1.500	1.1875	.820	.770	1.062	1.016	1.437	1.323	.234	1.237	.875
19	F	1.625	1.625	1.2500	.820	.770	1.156	1.110	1.531	1.449	.234	1.379	.975
21	G	1.750	1.750	1.3750	.820	.738	1.250	1.206	1.625	1.573	.204	1.489	1.053
23	H	1.875	1.875	1.5000	.820	.738	1.375	1.312	1.750	1.699	.204	1.619	1.195
25	J	2.000	2.000	1.6250	.820	.738	1.500	1.438	1.875	1.823	.204	1.744	1.233

All dimensions for reference only.

† Red band indicates fully mated

†† Blue band indicates rear release contact retention system

A

# PCB Box Mounting Receptacle

## Commercial (TVP02 & TVPS02)

PART NUMBER BUILDER Page 44-46  
ONLINE CONFIGURATOR [www.amphenol-aerospace.com](http://www.amphenol-aerospace.com)

<b>Commercial</b>	<b>ALUMINUM</b>	<b>STAINLESS STEEL</b>
	TVPS02RF	TVPS02RK
	TVP02RW	TVPS02RKN
	TVP02DT	TVPS02RS
	TVP02DZ	TVPS02RL
	TVPS02RB	

38999

- III
- II
- I
- SJT
- Access
- Aquacon

**Series III**



Shell Size	B Thread Class 2A (Plated) 0.1P-0.3L-TS	L Max. (TV)	L' Max. (CTV)	M +.000 -0.005 (TV)	M' +.000 -0.005 (CTV)	R1	R2	S Max.	T +.008 -0.006	AA Max. Panel Thickness	LL +.006 -0.000 (TV)	LL' ±.005 (CTV)	TT ±.008
9	.6250	.205	.250	.820	.773	.719	.594	.948	.128	.234	.905	.908	.216
11	.7500	.205	.250	.820	.773	.812	.719	1.043	.128	.234	.905	.908	.194
13	.8750	.205	.250	.820	.773	.906	.812	1.137	.128	.234	.905	.908	.194
15	1.0000	.205	.250	.820	.773	.969	.906	1.232	.128	.234	.905	.908	.173
17	1.1875	.205	.250	.820	.773	1.062	.969	1.323	.128	.234	.905	.908	.194
19	1.2500	.205	.250	.820	.773	1.156	1.062	1.449	.128	.234	.905	.908	.194
21	1.3750	.235	.280	.790	.741	1.250	1.156	1.575	.128	.204	.905	.904	.194
23	1.5000	.235	.280	.790	.741	1.375	1.250	1.701	.154	.204	.905	.904	.242
25	1.6250	.235	.280	.790	.741	1.500	1.375	1.823	.154	.204	.905	.904	.242

All dimensions for reference only.  
Most common options are shown; other options are available.

- Designates true position dimensioning
- † Red band indicates fully mated
- †† Blue band indicates rear release contact retention system

# PCB Box Mounting Receptacle (With Clinch Nuts)

## Commercial (TVP12 & TVPS12)

38999

PART NUMBER BUILDER Page 44-46

ONLINE CONFIGURATOR [www.amphenol-aerospace.com](http://www.amphenol-aerospace.com)

Commercial

ALUMINUM  
**TVPS12RF**  
**TVP12RW**  
**TVP12DT**  
**TVP12DZ**  
**TVPS12RB**

STAINLESS STEEL  
**TVPS12RK**  
**TVPS12RKN**  
**TVPS12RS**  
**TVPS12RL**

Series III



Shell Size	B Thread Class 2A (Plated) 0.1P-0.3L-TS	L Max. (TV)	L' Max. (CTV)	M +.000 - .005 (TV)	M' +.000 - .005 (CTV)	R	S Max.	T Thread	AA Max. Panel Thickness	LL +.006 - .000 (TV)	LL' +.006 - .000 (CTV)
9	.6250	.205	.250	.820	.773	.719	1.031	.112-40UNC-3B	.234	.905	.908
11	.7500	.205	.250	.820	.773	.812	1.125	.112-40UNC-3B	.234	.905	.908
13	.8750	.205	.250	.820	.773	.906	1.172	.112-40UNC-3B	.234	.905	.908
15	1.0000	.205	.250	.820	.773	.969	1.281	.112-40UNC-3B	.234	.905	.908
17	1.1875	.205	.250	.820	.773	1.062	1.375	.112-40UNC-3B	.234	.905	.908
19	1.2500	.205	.250	.820	.773	1.156	1.469	.112-40UNC-3B	.234	.905	.908
21	1.3750	.235	.280	.790	.741	1.250	1.562	.112-40UNC-3B	.204	.905	.904
23	1.5000	.235	.280	.790	.741	1.375	1.750	.112-40UNC-3B	.204	.905	.904
25	1.6250	.235	.280	.790	.741	1.500	1.875	.112-40UNC-3B	.204	.905	.904

All dimensions for reference only.  
 Most common options are shown; other options are available.

□ Designates true position dimensioning  
 † Red band indicates fully mated  
 †† Blue band indicates rear release contact retention system

A

# PCB Jam Nut Receptacle

## Commercial (TV07 & TVS07)

PART NUMBER BUILDER Page 44-46  
ONLINE CONFIGURATOR [www.amphenol-aerospace.com](http://www.amphenol-aerospace.com)

Commercial

ALUMINUM	STAINLESS STEEL
TVS07RF	TVS07RK
TV07RW	TVS07RKN
TV07DT	TVS07RS
TV07DZ	TVS07RL
TVS07RB	

38999

III
II
I
SJT
Access
Aquacon

Series III



Shell Size	A* +.000 -.010	B Thread Class 2A (Plated) 0.1P-0.3L-TS	C Max.	D1 +.010 -.000	D2 +.010 -.000	H Hex +.017 -.016	S ±.010	T +.010 -.000	V Thread Metric
9	.669	.6250	1.199	.700	.670	.875	1.062	.697	M12X1-6g
11	.769	.7500	1.386	.825	.770	1.000	1.250	.822	M15X1-6g
13	.955	.8750	1.511	1.010	.955	1.188	1.375	1.007	M18X1-6g
15	1.084	1.0000	1.636	1.135	1.085	1.312	1.500	1.134	M22X1-6g
17	1.208	1.1875	1.761	1.260	1.210	1.438	1.625	1.259	M25X1-6g
19	1.333	1.2500	1.949	1.385	1.335	1.562	1.812	1.384	M28X1-6g
21	1.459	1.3750	2.073	1.510	1.460	1.688	1.938	1.507	M31X1-6g
23	1.575	1.5000	2.199	1.635	1.585	1.812	2.062	1.634	M34X1-6g
25	1.709	1.6250	2.323	1.760	1.710	2.000	2.188	1.759	M37X1-6g

All dimensions for reference only.  
Most common options are shown;  
other options are available.

- † Red band indicates fully mated
- †† Blue band indicates rear release contact retention system
- ★ .059 dia. min. 3 lockwire holes. Formed lockwire hole design (6 holes) is optional. \*\*"D" shaped mounting hole dimensions

# PCB Jam Nut, Double Flange Receptacles

## Commercial (TVP47 & TVPS47)

38999

PART NUMBER BUILDER Page 44-46  
 ONLINE CONFIGURATOR [www.amphenol-aerospace.com](http://www.amphenol-aerospace.com)

Commercial	ALUMINUM	STAINLESS STEEL
	TVPS47RF	TVPS47RK
	TVP47RW	TVPS47RKN
	TVP47DT	TVPS47RS
	TVP47DZ	TVPS47RL



Shell Size	MS Shell Size Code (For Ref.)	B Thread Class 2A 0.1P-0.3L-TS (Plated)	C ±.005 (Jam Nut Flange Dia.)	D1 +.010 -0.000	D2 +.000 -0.010	H Hex +.017 -0.016	M Dia. ±.005 (TV)	M Dia. ±.005 (CTV)	R Thread Metric (Plated)	S +.011 -0.010	PCB Mounting Dimensions	
											V Dia. (TV) TP	W (CTV) TP
9	A	.6250	1.188	.700	.670	.875	1.062	1.016	M17X1-6g0.100R	1.062	.753	.532
11	B	.7500	1.375	.825	.770	1.000	1.062	1.148	M20X1-6g0.100R	1.250	.850	.601
13	C	.8750	1.500	1.010	.955	1.188	1.250	1.250	M25X1-6g0.100R	1.375	.994	.703
15	D	1.0000	1.625	1.135	1.085	1.312	1.375	1.375	M28X1-6g0.100R	1.500	1.119	.791
17	E	1.1875	1.750	1.260	1.210	1.438	1.500	1.500	M32X1-6g0.100R	1.625	1.237	.875
19	F	1.2500	1.937	1.385	1.335	1.562	1.625	1.625	M35X1-6g0.100R	1.812	1.379	.975
21	G	1.3750	2.062	1.510	1.460	1.688	1.750	1.750	M38X1-6g0.100R	1.937	1.489	1.053
23	H	1.5000	2.188	1.635	1.585	1.812	1.875	1.875	M41X1-6g0.100R	2.062	1.644	1.145
25	J	1.6250	2.312	1.760	1.710	2.000	2.000	2.000	M44X1-6g0.100R	2.188	1.744	1.233

All dimensions for reference only.

† Red band indicates fully mated

†† Blue band indicates rear release contact retention system.

★ .059 dia. min. (1.5 dia. min.) 3 lockwire holes.

Formed lockwire hole design (6 holes) is optional.

A

# PCB Hermetic Box Mounting Receptacle

## Commercial

38999



	1.	2.	3.	4.	5.	6.
<b>PART #</b>	Base Number	Coded Shell Size	Insert Arrg.	Contact Type/Alt. Keying	Shell Finish	Tail Length
See chart below	10-626	501	-35	P	1	B

## HOW TO ORDER

### 1. BASE NUMBER:

<b>10-626</b>	Base Number for MIL-DTL-38999 Series III Hermetic with PCB Tail
---------------	---

### 2. SELECT A CODED SHELL SIZE:

See chart below **501-509**, designates size 9-25 shell size.  
Example: **501** = Size 9 Shell

### 3. SELECT AN INSERT ARRANGEMENT:

Refer to insert availability chart on page 2-5 and pin-out illustrations on pages 14-28. Please enter the second number which represents the Insert Arrangement number.

<b>-35</b>	Designates Insert Arrangement Number
------------	--------------------------------------

### 4. CONTACT TYPE/ALTERNATE KEYING POSITIONS:

Refer to page 46 for alternate rotation letters to use.

<b>P</b>	Designates Pin Contacts in Normal Position
<b>S</b>	Designates Socket Contacts in Normal Position

### 5. SELECT A SHELL FINISH:

<b>1</b>	Hermetic seal, passivated Stainless Steel, 200°C
<b>2</b>	Hermetic seal, Stainless Steel w/Nickel Plate
<b>3</b>	Carbon Steel w/reflowed tin plate

### 6. SELECT A TAIL LENGTH:

<b>B</b>	.100±.03
<b>D</b>	.200±.03
<b>F</b>	.300±.03

Shell Size	Part Number	B Thread 0.1P-0.3L-TS (Plated)	R1	R2	S ±.010	T ±.008	TT ±.008
9	10-626 <b>501</b> -XXX	.6250	.719	.594	.938	.128	.216
11	<b>502</b> -XXX	.7500	.812	.719	1.031	.128	.194
13	<b>503</b> -XXX	.8750	.906	.812	1.125	.128	.194
15	<b>504</b> -XXX	1.0000	.969	.906	1.219	.128	.173
17	<b>505</b> -XXX	1.1875	1.062	.969	1.312	.128	.194
19	<b>506</b> -XXX	1.2500	1.156	1.062	1.438	.128	.194
21	<b>507</b> -XXX	1.3750	1.250	1.156	1.562	.128	.194
23	<b>508</b> -XXX	1.5000	1.375	1.250	1.688	.154	.242
25	<b>509</b> -XXX	1.6250	1.500	1.375	1.812	.154	.242

† Red band indicates fully mated

NOTE: Consult Amphenol Aerospace for availability of non-glass-sealed versions with printed circuit tail contacts.

All dimensions for reference.

Designates true position dimensioning

III

II

I

SJT

Access

Aquacon

Series III

A

# PCB Hermetic Jam Nut Receptacle

## Commercial

38999

III  
II  
I  
SJT  
Access  
Aquacon

Series III



	1.	2.	3.	4.	5.	6.
<b>PART #</b>	Base Number	Coded Shell Size	Insert Arrg.	Contact Type/Alt. Keying	Shell Finish	Tail Length
See chart below	10-626	47†	-35	P	I	B

## HOW TO ORDER

### 1. BASE NUMBER:

**10-626** Base Number for MIL-DTL-38999 Series III Hermetic with PCB Tail

### 2. SELECT A CODED SHELL SIZE:

See chart below **471-479**, designates size 9-25 shell size.

### 3. SELECT AN INSERT ARRANGEMENT:

Refer to insert availability chart on page 2-5 and pin-out illustrations on pages 14-28. Please enter the second number which represents the Insert Arrangement number.

**-35** Designates Insert Arrangement Number

### 4. CONTACT TYPE/ALTERNATE KEYING POSITIONS:

Refer to page 46 for alternate rotation letters to use.

<b>P</b>	Designates Pin Contacts in Normal Position
<b>S</b>	Designates Socket Contacts in Normal Position

### 5. SELECT A SHELL FINISH:

<b>1</b>	Hermetic seal, passivated Stainless Steel, 200°C
<b>2</b>	Hermetic seal, Stainless Steel w/Nickel Plate
<b>3</b>	Carbon Steel w/reflowed tin plate

### 6. SELECT A TAIL LENGTH:

<b>B</b>	100 ±.03
<b>D</b>	.200 ±.03
<b>F</b>	.300 ±.03

† Red band indicates fully mated

★ .059 dia. min. (1.5 dia. min.) 3 lockwire holes. Formed lockwire hole design (6 holes) is optional.

Shell Size	Part Number	A+ +.000 -.010	B Thread Class 2A 0.1P-0.3L- TS (Plated)	C Max	D1 +.010 -.000	D1 +.000 -.010	H Hex +.017 -.016	L Max	S ±.010	T+ +.010 -.000	KK +.011 -.000
9	<b>10-626471-XXX</b>	.669	.6250	1.199	.700	.670	.875	.357	1.062	.697	.642
11	<b>472-XXX</b>	.769	.7500	1.386	.825	.770	1.000	.357	1.250	.822	.766
13	<b>473-XXX</b>	.955	.8750	1.511	1.010	.955	1.188	.357	1.375	1.007	.892
15	<b>474-XXX</b>	1.084	1.0000	1.636	1.135	1.085	1.312	.357	1.500	1.134	1.018
17	<b>475-XXX</b>	1.208	1.1875	1.761	1.260	1.210	1.438	.357	1.625	1.259	1.142
19	<b>476-XXX</b>	1.333	1.2500	1.949	1.385	1.335	1.562	.381	1.182	1.384	1.268
21	<b>477-XXX</b>	1.459	1.3750	2.073	1.510	1.460	1.688	.381	1.938	1.507	1.392
23	<b>478-XXX</b>	1.575	1.5000	2.199	1.635	1.585	1.812	.381	2.062	1.634	1.518
25	<b>479-XXX</b>	1.709	1.6250	2.323	1.760	1.710	2.000	.381	2.188	1.759	1.642

All dimensions for reference only.

A



# PCB Hermetic Solder Mounting Receptacle

## Commercial



	1.	2.	3.	4.	5.	6.
<b>PART #</b> See chart below	Base Number 10-626	Coded Shell Size 481	Insert Arrg. -35	Contact Type/Alt. Keying P	Shell Finish 1	Tail Length B

## HOW TO ORDER

### 1. BASE NUMBER:

<b>10-626</b>	Base Number for MIL-DTL-38999 Series III Hermetic with PCB Tail
---------------	---

### 2. SELECT A CODED SHELL SIZE:

See chart below 481-489, designates size 9-25 shell size.

### 3. SELECT AN INSERT ARRANGEMENT:

Refer to insert availability chart on page 2-5 and pin-out illustrations on pages 14-28. Please enter the second number which represents the Insert Arrangement number.

<b>-35</b>	Designates Insert Arrangement Number
------------	--------------------------------------

### 4. CONTACT TYPE/ALTERNATE KEYING POSITIONS:

Refer to page 46 for alternate rotation letters to use.

<b>P</b>	Designates Pin Contacts in Normal Position
<b>S</b>	Designates Socket Contacts in Normal Position

### 5. SELECT A SHELL FINISH:

<b>1</b>	Hermetic seal, passivated Stainless Steel, 200°C
<b>2</b>	*Hermetic seal, Stainless Steel w/Nickel Plate
<b>3</b>	*Carbon Steel w/reflowed tin plate

### 6. SELECT A TAIL LENGTH:

<b>B</b>	.100±.03
<b>D</b>	.200±.03
<b>F</b>	.300±.03

† Red band indicates fully mated

Shell Size	Part Number	B Thread Class 2A 0.1P-0.3L- TS (Plated)	L +.011 -.005	M +.006 -.005	GG Dia. +.011 -.010	KK Dia +.011 -.005
9	<b>10-626481-XXX</b>	.6250	.806	.125	.750	.672
11	<b>482-XXX</b>	.7500	.806	.125	.844	.781
13	<b>483-XXX</b>	.8750	.806	.125	.969	.906
15	<b>484-XXX</b>	1.0000	.806	.125	1.094	1.031
17	<b>485-XXX</b>	1.1875	.806	.125	1.218	1.156
19	<b>486-XXX</b>	1.2500	.806	.125	1.312	1.250
21	<b>487-XXX</b>	1.3750	.806	.125	1.438	1.375
23	<b>488-XXX</b>	1.5000	.838	.156	1.563	1.500
25	<b>489-XXX</b>	1.6250	.838	.156	1.688	1.625

# PCB Hermetic Weld Mounting Receptacle

## Commercial

38999

III  
II  
I  
SJT  
Access  
Aquacon

Series III



	1.	2.	3.	4.	5.	6.
<b>PART #</b>	Base Number	Coded Shell Size	Insert Arrg.	Contact Type/Alt. Keying	Shell Finish	Tail Length
See chart below	10-626	49†	-35	P	1	B

## HOW TO ORDER

### 1. BASE NUMBER:

<b>10-626</b>	Base Number for MIL-DTL-38999 Series III Hermetic with PCB Tail
---------------	---

### 2. SELECT A CODED SHELL SIZE:

See chart below **491-499**, designates size 9-25 shell size.

### 3. SELECT AN INSERT ARRANGEMENT:

Refer to insert availability chart on page 2-5 and pin-out illustrations on pages 14-28. Please enter the second number which represents the Insert Arrangement number.

<b>-35</b>	Designates Insert Arrangement Number
------------	--------------------------------------

### 4. CONTACT TYPE/ALTERNATE KEYING POSITIONS:

Refer to page 46 for alternate rotation letters to use.

<b>P</b>	Designates Pin Contacts in Normal Position
<b>S</b>	Designates Socket Contacts in Normal Position

### 5. SELECT A SHELL FINISH:

<b>1</b>	Hermetic seal, passivated Stainless Steel, 200°C
<b>2</b>	*Hermetic seal, Stainless Steel w/Nickel Plate
<b>3</b>	*Carbon Steel w/reflowed tin plate

### 6. SELECT A TAIL LENGTH:

<b>B</b>	.100±.03
<b>D</b>	.200±.03
<b>F</b>	.300±.03

Shell Size	Part Number	B Thread Class 2A 0.1P-0.3L-TS (Plated)	L +.011 -.000	M +.006 -.005	GG Dia. +.011 -.010
9	<b>10-626491-XXX</b>	.6250	.806	.125	.973
11	<b>492-XXX</b>	.7500	.806	.125	1.095
13	<b>493-XXX</b>	.8750	.806	.125	1.221
15	<b>494-XXX</b>	1.0000	.806	.125	1.347
17	<b>495-XXX</b>	1.1875	.806	.125	1.434
19	<b>496-XXX</b>	1.2500	.806	.125	1.579
21	<b>497-XXX</b>	1.3750	.806	.125	1.721
23	<b>498-XXX</b>	1.5000	.838	.156	1.886
25	<b>499-XXX</b>	1.6250	.838	.156	1.973

\* Not available for weld mount. All dimensions for reference only.

A

# Hermetic Box Mounting Receptacle

## Military (D38999/21), Commercial (TVPS02)

PART NUMBER BUILDER Page 42-46  
ONLINE CONFIGURATOR [www.amphenol-aerospace.com](http://www.amphenol-aerospace.com)

**MILITARY**  
**D38999/21**

Commercial

**STAINLESS STEEL**  
**TVPS02Y**  
**TVPS02YN**



† Red band indicates fully mated

NOTE: Consult Amphenol Aerospace for availability of non-glass-sealed versions with printed circuit tail contacts.

Inches

Shell Size	MS Shell Size Coded	B Thread 0.1P-0.3L-TS (Plated)	R1	R2	S ±.010	T ±.008	TT ±.008
9	A	.6250	.719	.594	.938	.128	.216
11	B	.7500	.812	.719	1.031	.128	.194
13	C	.8750	.906	.812	1.125	.128	.194
15	D	1.0000	.969	.906	1.219	.128	.173
17	E	1.1875	1.062	.969	1.312	.128	.194
19	F	1.2500	1.156	1.062	1.438	.128	.194
21	G	1.3750	1.250	1.156	1.562	.128	.194
23	H	1.5000	1.375	1.250	1.688	.154	.242
25	J	1.6250	1.500	1.375	1.812	.154	.242

Millimeters

Shell Size	MS Shell Size Coded	R1	R2	S ±.25	T ±.20	TT ±.20
9	A	18.26	15.09	23.83	3.25	5.49
11	B	20.62	18.26	26.19	3.25	4.93
13	C	23.01	20.62	28.58	3.25	4.93
15	D	24.61	23.01	30.96	3.25	4.39
17	E	26.97	24.61	33.32	3.25	4.93
19	F	29.36	26.97	36.53	3.25	4.93
21	G	31.75	29.36	39.67	3.25	4.93
23	H	34.93	31.75	42.88	3.91	6.15
25	J	38.10	34.93	46.02	3.91	6.15

All dimensions for reference only

  Designates true position dimensioning

38999

- III
- II
- I
- SJT
- Access
- Aquacon

Series III

A

# Hermetic Jam Nut Receptacle

## Military (D38999/23), Commercial (TVS07)

38999

PART NUMBER BUILDER Page 42-46  
 ONLINE CONFIGURATOR [www.amphenol-aerospace.com](http://www.amphenol-aerospace.com)

MILITARY  
 D38999/23

Commercial  
 STAINLESS STEEL  
 TVS07Y  
 TVS07YN



† Red band indicates fully mated

★ .059 dia min.

1.5 dia min. 3 lockwire holes Formed lockwire hole design (6 holes) is optional.

Inches

Shell Size	MS Shell Size code	B Thread Class 2A 0.1P-0.3L-TS (Plated)	C Max	D <sup>1</sup> +.010 -0.000	D <sup>2</sup> +.000 -0.010	H Hex +.017 -0.016	L Max	S ±.010	KK +.011 -0.000
9	A	.6250	1.199	.693	.657	.875	.357	1.062	.642
11	B	.7500	1.386	.825	.770	1.000	.357	1.250	.766
13	C	.8750	1.511	1.010	.955	1.188	.357	1.375	.892
15	D	1.0000	1.636	1.135	1.085	1.312	.357	1.500	1.018
17	E	1.1875	1.761	1.260	1.210	1.438	.357	1.625	1.142
19	F	1.2500	1.949	1.385	1.335	1.562	.381	1.812	1.268
21	G	1.3750	2.073	1.510	1.460	1.688	.381	1.938	1.392
23	H	1.5000	2.199	1.635	1.585	1.812	.381	2.062	1.518
25	J	1.6250	2.323	1.760	1.710	2.000	.381	2.188	1.642

Millimeters

Shell Size	MS Shell Size code	C Max	D <sup>1</sup> +.25 -0.00	D <sup>2</sup> +.00 -0.25	H Hex +.43 -0.41	L Max	S ±.25	KK +.28 -0.00
9	A	30.45	17.60	16.70	22.23	9.07	26.97	16.31
11	B	35.20	20.96	19.59	25.40	9.07	31.75	19.46
13	C	38.38	25.65	24.26	30.18	9.07	34.93	22.66
15	D	41.55	28.83	27.56	33.32	9.07	38.10	25.86
17	E	44.73	32.01	30.73	36.53	9.07	41.28	29.01
19	F	49.50	35.18	33.91	39.67	9.68	46.02	32.21
21	G	52.65	38.35	37.08	42.80	9.68	49.23	35.36
23	H	55.85	41.53	40.26	46.02	9.68	52.37	38.56
25	J	59.00	44.70	43.43	50.80	9.68	55.58	41.71

All dimensions for reference only

A

# Hermetic Solder Mounting Receptacle

## Military (D38999/25), Commercial (TVSI)

PART NUMBER BUILDER Page 42-46  
ONLINE CONFIGURATOR [www.amphenol-aerospace.com](http://www.amphenol-aerospace.com)

**MILITARY**  
**D38999/25**

**Commercial**

**STAINLESS STEEL**  
**TVSIY**  
**TVSIYN**



† Red band indicates fully mated Inches

Shell Size	MS Shell Size Code	B Thread Class 2A 0.1P-0.3L-TS (Plated)	L +.011 - .005	M +.006 - .005	GG Dia. +.011 - .010	KK Dia +.011 - .005
9	A	.6250	.806	.125	.750	.672
11	B	.7500	.806	.125	.844	.781
13	C	.8750	.806	.125	.969	.906
15	D	1.0000	.806	.125	1.094	1.031
17	E	1.1875	.806	.125	1.218	1.156
19	F	1.2500	.806	.125	1.312	1.250
21	G	1.3750	.806	.125	1.438	1.375
23	H	1.5000	.838	.156	1.563	1.500
25	J	1.6250	.838	.156	1.688	1.625

Millimeters

Shell Size	MS Shell Size Code	L +.28 - .00	M +.15 - .13	GG Dia. +.28 - .25	KK Dia +.03 - .13
9	A	20.47	3.18	19.05	17.07
11	B	20.47	3.18	21.44	19.84
13	C	20.47	3.18	24.61	23.01
15	D	20.47	3.18	27.79	26.19
17	E	20.47	3.18	30.94	29.36
19	F	20.47	3.18	33.32	31.75
21	G	20.47	3.18	36.53	34.93
23	H	21.29	3.96	39.70	38.10
25	J	21.29	3.96	42.88	41.28

# Hermetic Wall Mounting Receptacle

## Military (D38999/27), Commercial (TVSHIY)

PART NUMBER BUILDER Page 42-46  
ONLINE CONFIGURATOR  
[www.amphenol-aerospace.com](http://www.amphenol-aerospace.com)

**MILITARY**  
**D38999/27**

**Commercial**

**STAINLESS STEEL**  
**TVSHIY**  
**TVSHIYN**

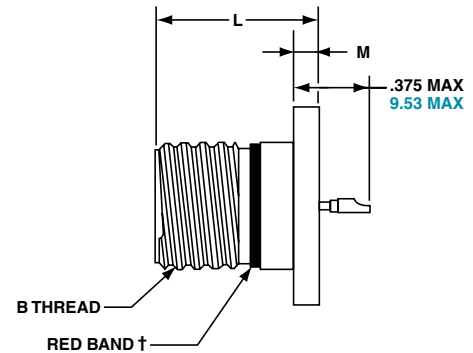

† Red band indicates fully mated Inches

Shell Size	MS Shell Size Code	B Thread Class 2A 0.1P-0.3L-TS (Plated)	L +.011 - .005	M +.006 - .005	GG Dia. +.011 - .010
9	A	.6250	.806	.125	.973
11	B	.7500	.806	.125	1.095
13	C	.8750	.806	.125	1.221
15	D	1.0000	.806	.125	1.347
17	E	1.1875	.806	.125	1.434
19	F	1.2500	.806	.125	1.579
21	G	1.3750	.806	.125	1.721
23	H	1.5000	.838	.156	1.886
25	J	1.6250	.838	.156	1.973

Millimeters

Shell Size	MS Shell Size Code	L +.28 - .00	M +.15 - .13	GG Dia. +.25 - .00
9	A	20.47	3.18	24.71
11	B	20.47	3.18	27.81
13	C	20.47	3.18	31.01
15	D	20.47	3.18	34.21
17	E	20.47	3.18	36.42
19	F	20.47	3.18	40.11
21	G	20.47	3.18	43.71
23	H	21.29	3.96	47.90
25	J	21.29	3.96	50.11

All dimensions for reference only

# Series III, TV Breakaway Fail-Safe Connectors

## Quick-Disconnect with an Axial Pull of Lanyard

38999

Amphenol® Tri-Start Breakaway Fail-Safe Connectors provide unequalled performance in environments requiring instant disengagement.

The “Breakaway” Fail-Safe connector family offers a wide range of electrical and mechanical features:

- Instant decoupling and damage free separation
- Completely intermateable with standard receptacles (D38999/20 and /24)
- Inventory support commonality through the use of standard insert arrangements and contacts

Breakaway unmating is initiated by applying a pull force to the lanyard which causes the operating sleeve on the plug to move away from the receptacle. Coupling segments on the plug then move away from the mating receptacle while expanding, thus releasing the receptacle. After completion of the unmating sequence, spring compression returns the sleeve and segments to their original positions. Unmating of the plug may also be accomplished by normal rotation of the coupling ring without affecting the breakaway capability.

The Tri-Start Breakaway Fail-Safe connector exceeds the MIL-Spec Series III requirements for EMI/EMP shielding and features include:

- Solid metal-to-metal coupling
- EMI grounding fingers
- Conductive finishes

Amphenol Breakaway Fail-Safe connectors are qualified to MIL-DTL-38999/29, /30 and /31 (for MIL-STD-1760 Stores Management applications). Amphenol also manufactures custom breakaway connectors including those with:

- Highly durable non-metallic operating sleeves in a variety of lengths and diameters
- Increased pull-force capability
- Low-profile designs
- Custom lanyard lengths and backshells
- Low force separation capabilities
- Low insertion/separation force contacts
- Non-cadmium finishes

Contact your local Amphenol representative. Whether you need a standard Breakaway, one of our custom Breakaways, or a unique Breakaway design.



TYPE 2

TYPE 6

TYPE 1

**Amphenol offers a variety of lanyard plug styles including MIL-STD-1760 types 1, 2 and 6 for Stores Management applications.**



*Breakaway with Coax Contacts*



Special configuration Fail-Safe used on space telescope application. Lanyard is replaced by a swivel ring for remote disconnect and “wing arms” have been added for manual actuation accessibility by gloved astronauts.

# TV Breakaway Fail-Safe Lanyard Release Plug

## Military (D38999/29 & D38999/30)

### HOW TO ORDER - MILITARY

1.	2.	3.	4.	5.	6.	7.
DOD Number Prefix	Spec Sheet Number	Service Class	Shell Size	Insert Arrangement	Lanyard Length Code	Alternate Keying Position
D38999/	29	F	E	35	P	N

#### 1. DOD NUMBER PREFIX

**D38999/** Designates MIL-DTL-38999, Series III, Tri-Start Connector

#### 2. SPECIFICATION SHEET NUMBER

**29** Lanyard Release Plug with pin contacts

**30** Lanyard Release Plug with socket contacts

#### 3. SERVICE CLASS

**F** Designates electroless nickel plated aluminum, optimum EMI shielding effectiveness -65dB@10 GHz specification min., 48 hour salt spray, 200°C

**W** Designates corrosion resistant olive drab cadmium plate aluminum, 500 hour extended salt spray, EMI -50dB@10 GHz specification min., 175°C

#### 4. & 5. INSERT AVAILABILITY

Shell Size- Insert Arrangement	Military Shell Size- Insert Arrangement	Commercial Basic Part# Shell & Insert Arrg. Code	Service Rating	Total Contacts	Contact Size							
					22D	20	16	12	12 Coax	8 Coax	8 Twinax	
11-2	N/A	88/91-556508	I	2			2					
11-35	N/A	06	M	13	13							
11-98	N/A	07	I	6		6						
13-4	N/A	10	I	4			4					
13-8	N/A	11	I	8		8						
13-35	N/A	14	M	22	22							
13-98	N/A	13	I	10		10						
15-5	N/A	18	II	5			5					
15-15	N/A	23	I	15		14	1					
15-18	N/A	22	I	18		18						
15-19	N/A	19	I	19		19						
15-35	N/A	20	M	37	37							
15-97	N/A	21	I	12		8	4					
17-6	E-6	27	I	6				6				
17-8	E-8	28	II	8			8					
17-26	E-26	29	I	26		26						
17-35	E-35	30	M	55	55							
17-99	E-99	31	I	23		21	2					
19-11	F-11	37	II	11			11					
19-32	F-32	39	I	32		32						
19-35	F-35	40	M	66	66							
21-11	G-11	47	I	11				11				
21-16	G-16	48	II	16			16					
21-35	G-35	49	M	79	79							
21-39	G-39	51	I	39		37	2					
21-41	G-41	50	I	41		41						
23-21	H-21	57	II	21			21					
23-35	H-35	58	M	100	100							
23-53	H-53	59	I	53		53						
23-54	H-54	61	M	53	40		9	4				
23-55	H-55	60	I	55		55						
25-4	J-4	71	I	56		48	8					
25-19	J-19	66	I	19				19				
25-20	J-20	74	N	30		10	13		4			3
25-24	J-24	72	I	24			12	12				
25-29	J-29	67	I	29			29					
25-35	J-35	68	M	128	128							
25-43	J-43	69	I	43		23	20					
25-46	J-46	73	I	46		40	4			2*		
25-61	J-61	70	I	61		61						

- III
- II
- I
- SJT
- Access
- Aquacon

Series III

A

# TV Breakaway Fail-Safe Lanyard Release Plug

## Military (D38999/29 & D38999/30)

38999

### 6. MILITARY LANYARD LENGTH CODE

Table II

Lanyard Length (in.) ± .236	Lanyard Length (mm) ± 6.0	Lanyard Length Code For Part Number
4.016	102	A
4.528	115	B
5.000	127	C
5.512	140	D
6.024	153	E
6.535	166	F
7.008	178	G
7.520	191	H
7.992	203	I
8.503	216	J
9.016	229	K
9.528	242	L
10.000	254	M
10.512	267	N
11.024	280	P
11.535	293	R
12.008	305	S
12.520	318	T
13.031	331	U
14.016	356	V
15.000	381	W
16.024	407	X
17.008	432	Y
18.031	458	Z

### 7. MILITARY ALTERNATE KEYING POSITION

For alternate positions of connector (to prevent cross-mating) (N indicates normal).

Shell Size	Key & Keyway Arrangement Identification Letter	AR° or AP° BSC	BR° or BP° BSC	CR° or CP° BSC	DR° or DP° BSC
7, 7H	N*	120	240	NA	NA
	A	132	248		
	B	80	230		
	C	140	275		
	D	155	234		
9	N*	105	140	215	265
	A	102	132	248	320
	B	80	118	230	312
	C	35	140	205	275
	D	64	155	234	304
11, 13, and 15	N*	95	141	208	236
	A	113	156	182	292
	B	90	145	195	252
	C	53	156	220	255
	D	119	146	176	298
17 and 19	N*	80	142	196	293
	A	135	170	200	310
	B	49	169	200	244
	C	66	140	200	257
	D	62	145	180	280
21, 23, and 25	N*	80	142	196	293
	A	135	170	200	310
	B	49	169	200	244
	C	66	140	200	257
	D	62	145	180	280
25L, 33, and 37	N*	80	142	188	293
	A	135	170	188	310
	B	49	169	188	244
	C	66	140	188	257
	D	62	145	188	280
	N*	80	153	197	272
	A	79	153	197	272
	B	79	153	197	272
	C	79	153	197	272
	D	79	153	197	272

RECEPTACLE (FRONT FACE SHOWN)



PLUG (FRONT FACE SHOWN)



Series III

A



# TV Breakaway Fail-Safe Lanyard Release Plug

## Commercial (88-5565 & 91-5565)

### HOW TO ORDER - COMMERCIAL

Ordering procedure for example part number 88-556529-EP is shown below:

1.	2.	3.	4.	5.	6.
Service Class	Connector Type Identification	Shell Size & Insert Arrg. Code	Required Field	Lanyard Length Code	Contact Type/Alternate Keying Position
88	-5565	29	0	E	P

#### 1. SERVICE CLASS

88	Designates corrosion resistant olive drab cadmium plate over nickel, 500 hour extended salt spray, EMI -50dB @ 10 GHz specification min., 175°C
91	Designates electroless nickel plated aluminum, optimum EMI shielding effectiveness -65dB @ 10 GHz specification min., 48 hour salt spray, 200°C

These are standard finishes. Consult Amphenol Aerospace for other variations.

#### 2. CONNECTOR TYPE IDENTIFICATION

-5565	Designates MIL-DTL-38999, Series III Tri-Start Lanyard Release Plug
-------	---

#### 3. SELECT A COMMERCIAL SHELL SIZE & INSERT ARRANGEMENT CODE

MIL-DTL-38999, see insert availability chart on page 71.

#### 4. REQUIRED FIELD

0	THE REQUIRED FIELD IS ALWAYS A 0
---	----------------------------------

#### 5. SELECT A LANYARD LENGTH CODE

Lanyard Length (in.) ± .236	Lanyard Length (mm) ± 6.0	Lanyard Length Code For Part Number
4.016	102	A
4.528	115	B
5.000	127	C
5.512	140	D
6.024	153	E
6.535	166	F
7.008	178	G
7.520	191	H
7.992	203	I
8.503	216	J
9.016	229	K
9.528	242	L
10.000	254	M
10.512	267	N
11.024	280	P
11.535	293	R
12.008	305	S
12.520	318	T
13.031	331	U
14.016	356	V
15.000	381	W
16.024	407	X
17.008	432	Y
18.031	458	Z

#### 6. SELECT A CONTACT TYPE/ALTERNATE KEYING POSITION

P designates pin, S designates socket for normal positioning of contacts. When an alternate position of the connector is required to prevent cross-mating, a different letter (other than P or S) is used. See alternate positioning on page 72, then convert to Amphenol Commercial coding by the following chart.

Pin Contacts		Socket Contacts	
MS Letter	Amphenol letter	MS Letter	Amphenol Letter
PN	<b>P (normal)</b>	SN	<b>S (normal)</b>
PA	<b>G</b>	SA	<b>H</b>
PB	<b>I</b>	SB	<b>J</b>
PC	<b>K</b>	SC	<b>L</b>
PD	<b>M</b>	SD	<b>N</b>
PE	<b>R</b>	SE	<b>T</b>

# Fail-Safe Lanyard Release Plug-Crimp, Metal

## Military (D38999/29 & D38999/30), Commercial (88-5565 & 91-5565)

38999

PART NUMBER BUILDER Page 71-73  
 ONLINE CONFIGURATOR [www.amphenol-aerospace.com](http://www.amphenol-aerospace.com)

**MILITARY**  
 D38999/29 Pin  
 D38999/30 Socket

**Commercial**  
 STAINLESS STEEL  
 88-5565  
 91-5565

### METAL

.374 MAX  
 9.50 MAX  
 OUTER SLEEVE MOVEMENT  
 DURING UNMATING THREAD RELEASE



† Blue band indicates rear release contact retention system

Inches

Shell Size	MS Shell Size Code	B Max	D Max Accessory Dia.
11	B	1.846	1.109
13	C	1.972	1.250
15	D	2.079	1.375
17	E	2.205	1.500
19	F	2.301	1.625
21	G	2.472	1.750
23	H	2.594	1.875
25	J	2.705	2.000

Millimeters

Shell Size	MS Shell Size Code	B Max	D Max Accessory Dia.	V Thread Metric
11	B	46.89	28.17	M15X1.0-6g
13	C	50.09	31.75	M18X1.0-6g
15	D	52.81	34.93	M22X1.0-6g
17	E	56.01	38.10	M25X1.0-6g
19	F	58.45	41.28	M28X1.0-6g
21	G	62.79	44.45	M31X1.0-6g
23	H	65.89	47.63	M34X1.0-6g
25	J	68.71	50.08	M37X1.0-6g

Series III

A

# TV Breakaway Fail-Safe Lanyard Release

## Military (D38999/31) Type 1 & 2 for MIL-STD-1760

Applications- Lanyard Release Plug

38999

III  
II  
I  
SJT  
Access  
Aquacon

### HOW TO ORDER - BY MILITARY PART NUMBER FAIL-SAFE D38999/31

Ordering procedure for example part number D38999/31WE20PN1 is shown below:

1.	2.	3.	4.	5.	6.	7.	8.
DOD Number Prefix	Spec Sheet Number	Service Class	Lanyard Length Code	Insert Arrangement	Contact Style	Alternate Keying Position	Type Number
D38999/	31	W	E	20	P	N	1

#### 1. DOD NUMBER PREFIX

D38999/	MIL-DTL-38999, Series III Tri-Start Connectors
---------	--

#### 2. SPECIFICATION SHEET NUMBER

31	Designates Lanyard Release Plug for MIL-STD-1760 with pin contacts
----	--

#### 3. SERVICE CLASS

F	Electroless nickel plated aluminum, optimum EMI shielding effectiveness -65dB @ 10 GHz specification min., 48 hour salt spray, 200°C
W	Corrosion resistant olive drab cadmium plate aluminum, 500 hour extended salt spray, EMI -50dB @ 10 GHz specification min., 175°C

#### 4. LANYARD LENGTH CODE

Lanyard Length (in.) ±.236	Lanyard Length (mm.) ± 6.0	Lanyard Length Code for Part Number
6.024	153.0	E
6.535	166.0	F
7.008	178.0	G
7.520	191.0	H
7.992	203.0	I
8.504	216.0	J
9.016	229.0	K
9.528	242.0	L

#### 5. INSERT ARRANGEMENT

11	25-11
20	25-20

#### 6. CONTACT STYLE-P & A ARE VALID OPTIONS

P	Replaces the "no designation" option in the PIN on revision C and earlier revision of the Mil-Spec.
A	Designates supplied less contacts.

#### 7. ALTERNATE KEYING POSITION

N	Is required for normal position.
---	----------------------------------

#### 8. TYPE NUMBER

TYPE 1, 2 OR 6. SEE DRAWINGS ON PAGE 76.

For accessories for lanyard release plugs see Accessories section.

**MILITARY**  
**D38999/31**

**TYPE 6**  
**88-555875/76**  
**91-555875/76**

**TYPE 2**  
**88-558518/19**  
**91-558518/19**

**TYPE 1-Longer Shell**  
**T3W-16B25-XXXX**

Series III

A

# TV Breakaway Fail-Safe Lanyard Release

## Military (D38999/31) for MIL-STD-1760 Crimp, Metal

PART NUMBER BUILDER  
Page 75

38999

III

II

I

SJT

Access

Aquacon

Series III

PIN CONTACTS ONLY, SHELL SIZE 25 ONLY



**MILITARY**  
**D38999/31**

**TYPE 6**  
**88-555875/76**  
**91-555875/76**

**TYPE 2**  
**88-558518/19**  
**91-558518/19**

**TYPE 1**  
**T3W-16B25-XXXX**



**TYPE 1**  
**(LONGER SHELL)**

† Blue band indicates rear release contact retention system  
\*\* Lanyard pulled taut against a .500 ± .13 dia. Mandrel  
All dimensions for reference only

### TRI-START LANYARD SEPARATION FORCES

Shell Size	Straight Plug (lbs. max.)	15 Degree Pull (lbs. max.)
25	90	100

**INSERT AVAILABILITY**  
**FAIL SAFE D38999/31**  
**FOR MIL-STD-1760**

### PIN CONTACT DATA FOR MIL-STD-1760

Insert Arrangement	Service Rating	Total Contacts	Contact			
			20	16	12 (Coax)	8 (Twinax)
25-20	N	30	10	13	4	3

### CONTACTS FOR 25-20 PATTERN

Shell Size	Arrg. Number	Number of Contacts	Size Contacts	Service Rating	Contact Location	Standard Contacts	
						Pin	Socket
25	-20	3	8	Twinax	A, H, K	M39029/90-529	M39029/91-530
		4	12	Coax	2,3	M39029/28-211	M39029/75-416
		13	16	N	C, D, E, F, J, M, N, P, R, T, U, Y, Z	M39029/102-558	M39029/103-559
						M39029/58-364	M39029/56-352
10	20	N	B, G, L, S, V, X, 1, 4, 6, 7	M39029/58-363	M39029/56-351		

Insert Arrangement	Service Rating	Total Contacts	Contact Size	
			20	10 (power)
25-11	N	11	2	9



**25-20**  
**PRIMARY INTERFACE**  
**SIGNAL SET**



**25-11**  
**AUXILIARY POWER**  
**SIGNAL SET**



8 (twinax) 10 (power) 12 (coax) 16 20

# TV Breakaway Fail-Safe Lanyard Release

## Commercial version of D38999/31, Type 6

38999

III  
II  
I  
SJT  
Access  
Aquacon

Series III

### QUICK-DISCONNECT WITH AN AXIAL PULL OF LANYARD

Amphenol offers a commercial version of D38999/31 series III, type 6 connectors. Built from the same time-tested and quality components used in its Mil-Spec counterpart, Amphenol's commercial variant is designed to accept a wider variety of insert arrangements the Mil-Spec does not include. Available in shell size 25, these fail-safe connectors adopt an incredible amount of versatility without sacrificing performance or durability. Consult Amphenol Aerospace for more information.

### FEATURES AND BENEFITS

- More versatile than the mil-spec
- 25 lanyards lengths
- Available in all size 25 arrangements
- Low force separation capabilities
- Compatible with all mil-spec backshells and accessories
- Mates to existing D38999 receptacles

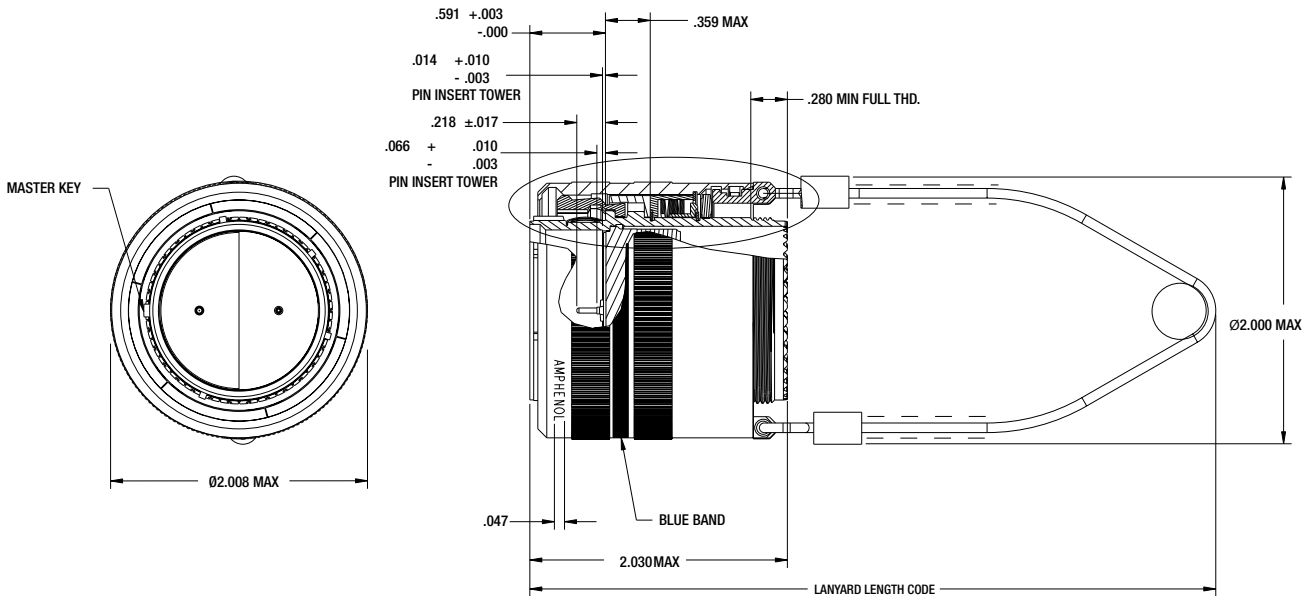

# TV Breakaway Fail-Safe Lanyard Release Connector

## Commercial (88-725010, 88-725014, 88-725041) Version of D38999/31 Type 6

38999

### HOW TO ORDER

1.	2.	3.	4.	5.
Service Class	Shell Style	Insert Arrg.	Alternate Keying Position (End A)	Lanyard Length Code
88	725010-	04	P	K

#### 1. FINISH\*

88-	Olive Drab Cadmium
91-	Electroless Nickel

\* Contact Amphenol for availability of other finishes.

#### 2. SHELL STYLE

725010-	D38999/31 Type 6
725014-	Extended Backskirt
725041-	Integrated Banding Platform

#### 3. INSERT ARRANGEMENT

04	25-4
07	25-7
11	25-11
17	25-17
20	25-20
24	25-24
26	25-26
29	25-29
35	25-35
37	25-37
41	25-41
43	25-43
46	25-46
61	25-61
62	25-62
90	25-90
F4	25-F4
187	25-187

#### 4. KEYING

Key Position	Pin	Socket
N	P	S
A	G	H
B	I	J
C	K	L
D	M	N
E	R	T

#### 5. LANYARD LENGTH CODE

Lanyard Length (in.) ± .236	Lanyard Length (mm) ± 6.0	Lanyard Length Code For Part Number
4.016	102	A
4.528	115	B
5.000	127	C
5.512	140	D
6.024	153	E
6.535	166	F
7.008	178	G
7.520	191	H
7.992	203	I
8.503	216	J
9.016	229	K
9.528	242	L
10.000	254	M
10.512	267	N
11.024	280	P
11.535	293	R
12.008	305	S
12.520	318	T
13.031	331	U
14.016	356	V
15.000	381	W
16.024	407	X
17.008	432	Y
18.031	458	Z

### INSERT ARRANGEMENTS

Shell Size & Insert Arrg. for:

Series III TV	25-04	25-07	25-08	25-11***
Service Rating	I	M	Twinax	N
Number of Contacts	48 8	97 2	8	2 9
Contact Size	20 16	22D 8 Twinax	8 Twinax	20 10

Shell Size & Insert Arrg. for:

Series III TV	25-17	25-19	25-20***	25-24
Service Rating	M	I	N	I
Number of Contacts	36 6	19	10 13 3 4	12 12
Contact Size	22D 8 Twinax	12	20 16 8 Twinax 12 Coax	16 12

A

# Insert Arrangements

## Commercial (88-725010 & 88-725014) Version of D38999/31 Type 6

38999

III  
II  
I  
SJT  
Access  
Aquacon

Series III



Shell Size & Insert Arrg. for:

Series III TV	25-26			25-29			25-35			25-37		
Service Rating	I			I			M			I		
Number of Contacts	16	5	4	29			128			37		
Contact Size	20	12	8 Coax	16			22D			16		



Shell Size & Insert Arrg. for:

Series III TV	25-41					25-43		25-46			25-61	
Service Rating	N/Inst.					I		I			I	
Number of Contacts	22	3	11	2	3	23	20	40	4	2	61	
Contact Size	22D	20	16	12 Coax	8 Twinax	20	16	20	16	8 Coax †	20	



Shell Size & Insert Arrg. for:

Series III TV	25-62		25-90			25-F4			25-187 HD	
Service Rating	I		I			Size 22D=M, Balance =I			N	
Number of Contacts	8	4	40	4	2	49	13	4	187	
Contact Size	16	8	20	16	8 Twinax	22D	16	12	23	

Ground Plane Only

### SPECIALS



Shell Size & Insert Arrg. for:

Series III TV	25-92		25-97			25-16		25L-3		25L-7	
Service Rating	M		M			M		II		II	
Number of Contacts	92	9	26	3	13	6	2	1	2	7	
Contact Size	22D	16	22D	16	12	20	4	8	4	8	

# TV Breakaway Fail-Safe Lanyard Release Connector

## Commercial (88-725014 & 88-725041) Version of D38999/31 Type 6

38999

### 88-725041 INTEGRATED BANDING PLATFORM



### 88-725014 EXTENDED BACKSKIRT



Series III

A



# D38999 Type Hybrid Breakaway – Series III

## Lower Profile Lanyard Release Plug, Crimp

### METAL SHELLS WITH COMPOSITE OPERATING SLEEVE

New Hybrid Lanyard Breakaway Fail-Safe connector with a composite thermoplastic outer operating sleeve for greater durability.

This new hybrid breakaway is the breakaway of choice for the Navy F-18 Program. Amphenol's hybrid lanyard design offers greater durability over D38999 aluminum and composite designs because of its ability to handle abuse taken after weapons release.

Other advantages include:

- Lower profile compared to full metal breakaway Fail-Safe connectors
- Less weight

This Hybrid Breakaway meets the applicable requirements of MIL-DTL-38999/31 including random & sine vibration, ice resistance, fluid immersion and hydrolytic stability tests. (Test reports are available upon request).

Currently the hybrid breakaway is available in shell sizes 25 and 17. It uses standard inserts available for breakaway plugs sizes 25 and 17, and is also available with inserts 25-20 and 25-11 for MIL-STD-1760. These hybrid connectors will accommodate the standard backshells for breakaway connectors shown on Accessories section or the backshell section.

[Consult Amphenol Aerospace for ordering of the new hybrid breakaway connectors.](#)



*New Hybrid Lanyard Release Plugs (Metal inside shells and Composite, lower profile outer sleeves)*

CONDITION/TEST	DESCRIPTION	REFERENCE
Durability	400 complete mating/unmating cycles	MIL-DTL-38999/31D
High Impact Shock	Nine hammer blows from 1,3 and 5 feet, three each in three axes on mounting panel.	MIL-S- 901D
Vibration	10 to 2000Hz in three perpendicular axes, 4 hours in each axis for a total of 12 hours with no fracturing or breaking of parts.	MIL-STD-202F, Method 204
Ice Resistance	Pull tested after conditioned with Ice water at -18C for 35 minutes.	MIL-DTL-38999/31D
Fail Safe Disengagement	Rotationally unmated 180° from full mate position and pull tested in both a straight direction and at 15°.	MIL-DTL-38999/31D
High Speed Pull Separation	100 cycles at 30 feet per second.	MIL-DTL-38999/31D

### STORES MANAGEMENT TYPE II, RAIL LAUNCH

#### Plugs and Receptacles that meet MIL-STD-1760

Amphenol provides a Breakaway Rail Launch connector that is designed for use on aircraft that carry rail launch missiles such as AMRAAM.

These connectors are designed for blindmating of stores on rail launch applications. They consist of a buffer plug and a missile receptacle that meet the specifications of MIL-STD-1760 Stores Management.

Other features and benefits include:

- Designed to MIL-C-83538 specifications
- Bayonet and push pull coupling
- Use standard MIL-DTL-38999 crimp termination with power, coax and twinax contacts also available
- Buffer provides flame barrier
- Buffers are replaceable

[Consult Amphenol Aerospace for more information and ordering.](#)



*Stores Management Type II Rail Launch Connectors*

38999

III

II

I

SJT

Access

Aquacon

Series III

A

## X-ON Electronics

Largest Supplier of Electrical and Electronic Components

*Click to view similar products for [Circular MIL Spec Backshells](#) category:*

*Click to view products by [Amphenol](#) manufacturer:*

Other Similar products are found below :

[60-036152-022](#) [610HS012M15](#) [M28840/504WA](#) [M28840/805WB](#) [M28840/809WA](#) [M28840/815WA](#) [M28840/816WA](#) [627AS017M14](#)  
[627MA124M14S](#) [655HS002NF11](#) [CW3899-000](#) [M85049/10-134S](#) [M85049/10-17S](#) [M85049/10-33S](#) [M85049/10-94W](#) [M85049/11-28N](#)  
[M85049/11-37N](#) [M85049/11-53N](#) [M85049/11-63N](#) [M85049/124-23W](#) [M85049/1720N04B](#) [M85049/1821W05C](#) [M85049/1825W06C](#)  
[M85049/1919N05](#) [M85049/23-74W](#) [M85049/24-71N](#) [M85049/25-47N](#) [M85049/25-94W](#) [M85049/27S12N](#) [M85049/39-11S](#) [M85049/39-17S](#)  
[M85049/39-9S](#) [M85049/6-10B](#) [M85049/6-19N](#) [M85049/6-20B](#) [M85049/77-20W04](#) [M85049/78-11N03](#) [M85049/78-15W02](#) [M85049/78-](#)  
[17N04](#) [M85049/78-19N05](#) [M85049/79-19N07](#) [M85049/79-25N04](#) [M85049/82-18N02](#) [M85049/82-22P02](#) [M85049/83-10W03](#) [M85049/84-](#)  
[20N03](#) [M85049/8-48N](#) [M85049/85-24N01](#) [M85049/85-24P01](#) [M85049/86-16P03](#)