

Modules de distribution à jonction rapide



Quick junction modules

Edition 05/12

Amphenol Air LB

SYSTEMES DE CONNEXIONS ELECTRIQUES ET ELECTRONIQUES
ELECTRIC AND ELECTRONIC CONNECTION SYSTEMS

SOMMAIRE

TABLE OF CONTENTS



MODULES TYPE 1750 & DERIVES

Modules 1750	6
Présentation	7
Caractéristiques Techniques	8
Système de référence	8
Modules 1750 pour contacts à sertir	9-10
Modules de masse 1750	11
Modules 1750 à piquer sur C.I.	12
Modules 1750 à Diodes insérées	12
Modules 1750 à Tige	13
Référentiel	14
Modules 1765 Porte-Composants	16
Présentation	17
Caractéristiques Techniques	17
Modules 1765 à composants soudés sur C.I.	18
Modules 1765 à composants soudés sur Plots	19
Référentiel	20
Modules 1767 PA	22
Présentation	23
Caractéristiques Techniques	24
Système de référence	24
Modules 1767 PA	25
Référentiel	26

MODULES TYPE 1100 & DERIVES

Modules 1100	30
Présentation	31
Caractéristiques Techniques	32
Système de référence	32
Modules 1100	33-34
Modules de masse 1100	34
Modules 1100 fûts à souder	35
Modules 1100 à piquer sur C.I.	35
Fixations individuelles	36
Modules 1130 - A Diodes insérées	37
Modules 1130 - A Résistances insérées	38
Blocs de jonction à tige - BJT	39-40
Blocs de jonction porte-composants	41-43
Référentiel	44-45
Modules 1200 - Micro-intensité - ABS 1569	46
Présentation	47
Caractéristiques Techniques	47
Système de référence	48
Modules 1200	48
Dimensions Barettes 1100 & 1200	49

MODULES AUX NORMES MIL

Modules MIL-T-81714 Série I	52
Présentation	53
Caractéristiques Techniques	53
Modules	54-56
Modules Haute Densité	57
Référentiel	58
Modules MIL-T-81714 Série II	60
Présentation	61
Caractéristiques Techniques	61
Modules	62-63
Modules de masse	64
Référentiel	65

MODULES 1750 SERIES & DERIVED

1750 Modules	
<i>Presentation</i>	
<i>Technical data</i>	
<i>Part numbering system</i>	
<i>1750 Modules for crimped contacts</i>	
<i>1750 Grounding modules</i>	
<i>Straight PCB 1750 module</i>	
<i>1750 Modules with inserted Diodes</i>	
<i>1750 Stud modules</i>	
<i>Part numbering table</i>	
1765 Component Carrier Modules	
<i>Presentation</i>	
<i>Technical data</i>	
<i>1765 Modules with Components Soldered on PCB</i>	
<i>1765 Modules with Components Soldered on Pads</i>	
<i>Part numbering table</i>	
1767 PA Modules	
<i>Presentation</i>	
<i>Technical data</i>	
<i>Part numbering system</i>	
<i>1767 PA Modules</i>	
<i>Part numbering table</i>	

MODULES 1100 SERIES & DERIVED

1100 Modules	
<i>Presentation</i>	
<i>Technical data</i>	
<i>Part numbering system</i>	
<i>1100 modules</i>	
<i>1100 Grounding modules</i>	
<i>1100 Solder Cup modules</i>	
<i>Straight PCB 1100 modules</i>	
<i>Individual mounting brackets</i>	
<i>1130 Modules - With inserted Diodes</i>	
<i>1130 Modules - With inserted Resistances</i>	
<i>Stud junction blocks - BJT</i>	
<i>Component carrier junction blocks</i>	
<i>Part numbering table</i>	
1200 Modules - Micro-intensity - ABS 1569	
<i>Presentation</i>	
<i>Technical data</i>	
<i>Part numbering system</i>	
<i>1200 Modules</i>	
<i>1100 & 1200 Rail dimensions</i>	

MIL. SPEC. MODULES

Serie I MIL-T-81714 Modules	
<i>Presentation</i>	
<i>Technical data</i>	
<i>Modules</i>	
<i>High density modules</i>	
<i>Part numbering table</i>	
Serie II MIL-T-81714 Modules	
<i>Presentation</i>	
<i>Technical data</i>	
<i>Modules</i>	
<i>Grounding modules</i>	
<i>Part numbering table</i>	

SOMMAIRE

TABLE OF CONTENTS



MODULES CIRCULAIRES & PROLONGATEURS

Modules Circulaires de Masse

Présentation	69
Caractéristiques Techniques	70
Modules Circulaires pour contacts mâles	71
Modules Circulaires pour contacts femelles	71
Modules Circulaires à Résistance - Contacts femelles	72

Modules Circulaires de Traversée - Fûts à Souder

Présentation	75
Caractéristiques Techniques	75
Module Circulaire de traversée	76
Module Circulaire - Contacts Fûts à souder	76

Prolongateurs et Bornes ABS & NSA

Caractéristiques Techniques des prolongateurs et bornes	79
Présentation des prolongateurs	79
Prolongateurs pour contacts câble cuivre	80
Prolongateurs pour contacts câble aluminium	81
Prolongateurs à composants	81
Prolongateurs à diodes insérées	82
Prolongateurs à fusibles insérés	82
Prolongateurs à résistances insérées	83
Présentation des bornes	83
Bornes à visser	84
Bornes à sertir	85
Référentiel	86

Prolongateurs MIL-81714 & dérivés

Présentation	89
Caractéristiques Techniques	89
Prolongateurs M81714 série I	90
Prolongateurs M81714 série II	90
Prolongateurs Push & Pull 1 contact	91
Prolongateurs Push & Pull 3 contacts	91
Prolongateurs Twist & Lock 2 contacts	92
Prolongateurs Twist & Lock 3 contacts	92
Prolongateurs Twist & Lock 4 contacts	93
Prolongateurs Twist & Lock 5 contacts	93
Prolongateurs Twist & Lock 8 contacts	94
Prolongateurs Twist & Lock 9 contacts	94
Supports	95
Référentiel	95

ACCESSOIRES

Rails Métalliques	97-99
Butée d'arrêt	100
Rails Composites	100-101
Étiquettes pour modules	101-102
Référentiel	102-103

CONTACTS & OUTILLAGES

Contacts	105-106
Obturateurs d'étanchéité	106
Outils pour Contacts	107
Outils pour Modules	108
Référentiel	108

PROCEDURES

Procédure de câblage des contacts électriques	111-112
Modules 1767PA - Procédures de Câblage	113-115
Modules 1767PA - Montage/Démontage sur Rail Métallique	116
Modules 1767PA - Montage/Démontage sur Rail Composite	116
Modules 1100 & 1200 - Montage/Démontage sur Rail Métallique	117

REFERENTIEL GENERAL

118-129

CIRCULAR MODULES & SPLICES

Circular Grounding Modules

Présentation	
Technical data	
Circular modules for pin contacts	
Circular modules for socket contacts	
Circular modules with Resistor - Socket contacts	

Grounding - Solder Cup Circular Modules

Présentation	
Technical data	
Feedthru Circular module	
Circular module - Solder Cup contacts	

ABS & NSA Terminal Blocks & Splices

Technical data for splices and terminals	
Presentation of splices	
Splices for copper cable contacts	
Splices for aluminum cable contacts	
Splices with components	
Splices with inserted Diodes	
Splices with inserted Fuses	
Splices with inserted Resistances	
Presentation of terminals	
Screw mounting terminals	
Crimp terminals	
Part numbering table	

MIL-81714 splices & derived

Présentation	
Technical data	
Serie I M81714 splices	
Serie II M81714 splices	
1 contact Push & Pull splices	
3 contacts Push & Pull splices	
2 contacts Twist & Lock splices	
3 contacts Twist & Lock splices	
4 contacts Twist & Lock splices	
5 contacts Twist & Lock splices	
8 contacts Twist & Lock splices	
9 contacts Twist & Lock splices	
Cradles	
Part numbering table	

ACCESSORIES

Metallic rails	
End stop	
Composite rails	
Marking tags for modules	
Part numbering table	

CONTACTS & TOOLING

Contacts	
Sealing plugs	
Tools for Contacts	
Tools for Modules	
Part numbering table	

INSTRUCTIONS

Wiring instructions for electrical contacts	
1767PA Modules - Wiring Instructions	
1767PA Modules - Mounting/Unmounting on Metallic Rail	
1767PA Modules - Mounting/Unmounting on Composite Rail	
1100 & 1200 Modules - Mounting/Unmounting on Metallic Rail	

GENERAL PART NUMBERING TABLE

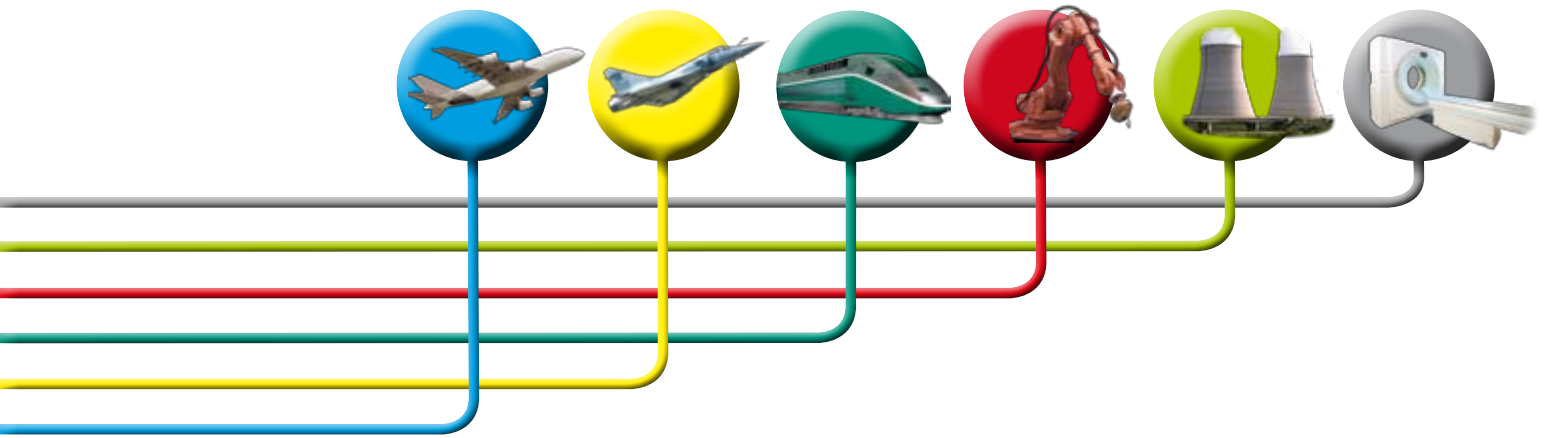

Modules type 1750 et Dérivés

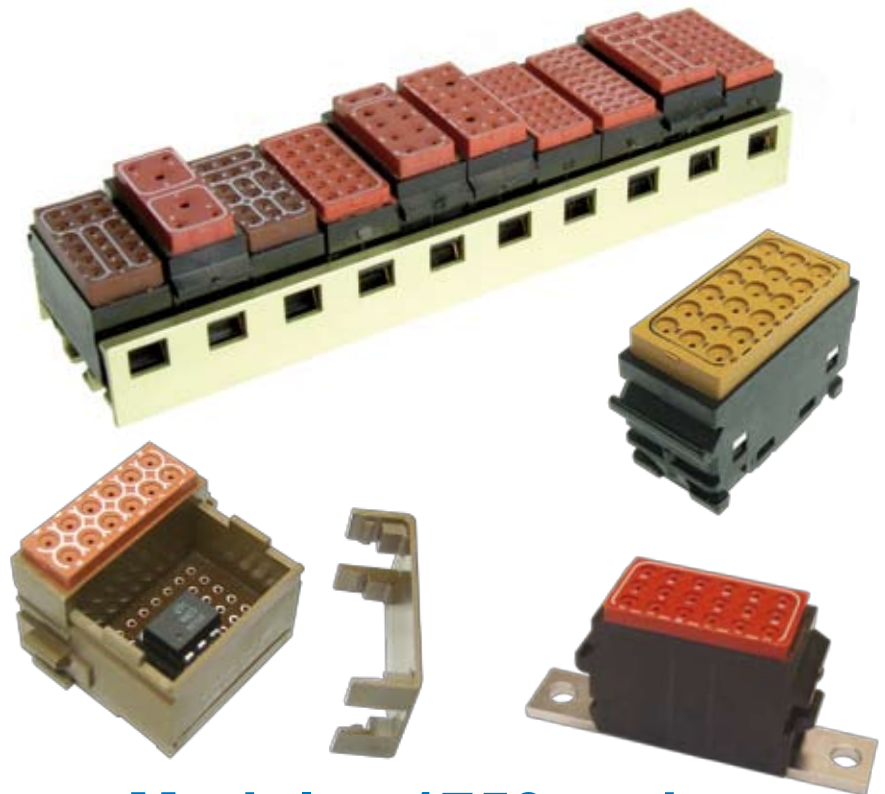

Modules 1750 series and Derived

Edition 05/12

Amphenol Air LB

SYSTEMES DE CONNEXIONS ELECTRIQUES ET ELECTRONIQUES
ELECTRIC AND ELECTRONIC CONNECTION SYSTEMS

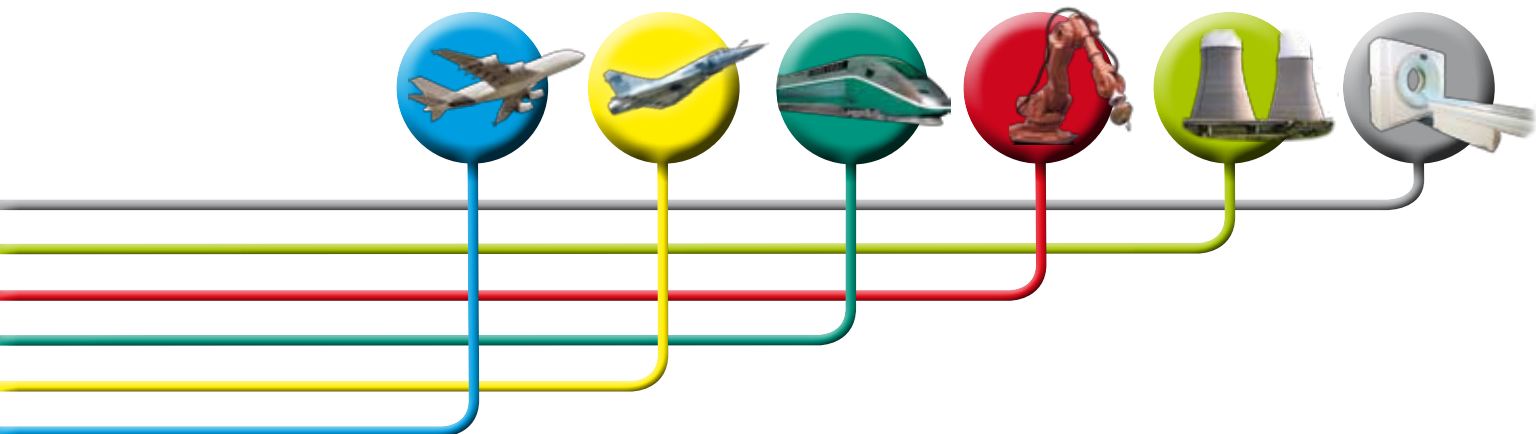

Modules 1750



1750 Modules

Edition 05/12

Amphenol Air LB

SYSTEMES DE CONNEXIONS ELECTRIQUES ET ELECTRONIQUES
ELECTRIC AND ELECTRONIC CONNECTION SYSTEMS

PRESENTATION

PRESENTATION



Les modules de distribution **type 1750** offrent des connexions modulaires à très haute densité de câblage, des performances très élevées et une mise en oeuvre rapide et aisée.

Ils se montent par insertion et se démontent par extraction sans outil spécial, en partie ou sur toute la longueur d'un rail métallique dissymétrique muni d'un ressort, ou d'un rail composite qui assure le verrouillage de chaque module. A chaque instant, il est possible de changer un module sans intervenir sur ses voisins.

Tous les modules sont au pas de 14 mm. Ils conviennent pour des contacts à sertir normalisés tailles 22-20-16-12 et 10 pour des gauges 26 à 8 AWG qui correspondent à des sections de câbles de 0,15 à 8,98 mm².

- NORMALISES NF/UTE C93-462

- Câblage à **TRÈS HAUTE DENSITE MODULAIRE** avec des outils normalisés.
- Contacts à sertir (P) tailles 22 - 20 - 16 - 12 et 10 - Gauges 26 à 8 AWG, normalisés **NF L53-105 - EN 3155-016**.
- **INTERVENTION RAPIDE** : Modules montés et démontés indifféremment, en partie ou sur toute la longueur du rail, sans outil spécial.
- Etanchéité des modules, assurée par surmoulage de joint à très grande adhérence.
- Points de contact repérés alphabétiquement sur le joint hermétique.
- Arrangements des contacts indiqués par une ligne blanche qui symbolise les circuits électriques.
- Nombreux schémas d'interconnexion dans toutes les tailles.
- Module de masse sur rail métallique
- Rails **METALLIQUE** ou **COMPOSITE** (gain de masse 60%)
- Les modules **Amphenol Air LB type 1750**, s'assemblent sur le même rail avec : **des modules à retour, hétérogènes, à diodes insérées, à porte-composants et avec des modules à tiges (BJT)**.
- Mélange des tailles et des arrangements.
- Chaque module est muni d'un porte-étiquette de repérage.

*Distribution modules **type 1750** provide wiring high density modular connections, very high performance, easy and fast installation.*

They may be inserted and extracted without special tools, in part or all along the dissymmetrical metallic rail with spring or a composite rail which locks each module in place. Modules may be changed at any time without removing adjacent modules.

All modules have the same pitch of .551 inch. They are suited for standard crimp contacts sizes 22-20-16-12 and 10 for 26 to 8 AWG which correspond to cable cross sections from 0.15 to 8.98 mm².

- NF/UTE C93-462 STANDARD

- **VERY HIGH DENSITY CONTACT POINTS**, wired with standard tools.
- Crimp contacts (P) sizes 22 - 20 - 16 - 12 and 10 - from 26 to 8 AWG. **NF L53-105 - EN 3155-016** standards.
- **QUICK MAINTENANCE** : Modules assembled and disassembled, either in sections or on the whole length of the rail, without special tools.
- Sealing of modules is ensured by a patented overmoulded grommet.
- Points of contacts are identified alphabetically on the hermetic sealed grommet.
- Contact layouts are indicated with a white line symbolizing electrical circuits.
- Broad range of interconnection layouts available in all sizes.
- **Grounding module on metallic rail**
- **METALLIC** or **COMPOSITE** rails (with 60% weight saving)
- **Amphenol Air LB modules type 1750** can be assembled on the same rail with **feedback modules, mixed modules, with inserted diodes, component carrier module, grounding modules and terminal junction blocks (BJT)**.
- Mixed sizes and layouts are available.
- Each module has a reference tag holder for easier identification.

CARACTERISTIQUES TECHNIQUES

TECHNICAL DATA



MECANIQUE

Module	Matière	: Thermoplastique
Joint	Matière	: Elastomère silicone
Contact	Matière	: Alliage cuivreux
	Protection	: Or sur nickel
Endurance		: 10 cycles complets de montage/démontage du contact dans la cavité
Vibrations		: Sinusoïdales fréquence de 10 à 2000 Hz accélération 10 g. 12cycles discontinuité ≤ 1 µs
Chocs		: 100 g 1/2 sinus, 6 ms (3 chocs dans 3 directions)
Rétention contacts	taille 22	: 5,4 daN
	taille 20	: 9 daN
	taille 16	: 11,4 daN
	taille 12	: 13,6 daN
	taille 10	: 13,6 daN

RESISTANCE AUX FLUIDES

Tenue : Conforme normes UTE C93-462

CLIMATIQUE

Température d'utilisation : -55°C à +175°C
 Endurance : 1000h à 175°C
 Chaleur humide : 21j suivant la norme EN 2591-304
 Tenue au Brouillard Salin : 48h

ELECTRIQUE

Tension de tenue au niveau de la mer et 23 000 mètres :
 1 500 V eff. 50 Hz
 Résistance d'isolement : ≥ à 5 000 MΩ
 Résistance de contacts : taille 22 : 5 mΩ
 taille 20 : 4 mΩ
 taille 16 : 3 mΩ
 taille 12 : 2 mΩ
 Intensité maxi du contact : taille 22 : 5 A
 taille 20 : 7,5 A
 taille 16 : 13 A
 taille 12 : 23 A
 taille 10 : 33 A (ref : 001104 630 02)
 46 A (ref : 001104 620 02)

MECHANICAL

Module	Material	: Thermoplastic
Grommet	Material	: Silicon elastomer
Contact	Material	: Copper alloy
	Plating	: Gold on nickel
Endurance		: 10 complete mounting/unmounting cycles of contacts into the cavity
Vibrations		: Sinusoidal frequency from 10 to 2000 Hz acceleration 10 g. 12cycles discontinuity ≤ 1 µs
Shocks		: 100 g 1/2 sinus, 6 ms (3 shocks in 3 directions)
Contact retention	size 22	: 5,4 daN
	size 20	: 9 daN
	size 16	: 11,4 daN
	size 12	: 13,6 daN
	size 10	: 13,6 daN

RESISTANCE TO FLUIDS

Resistance : Complies with standards UTE C93-462

ENVIRONMENT

Operating temperature : -55° to +175°C
 Endurance : 1000h to 175°C
 Damp heat : 21j as per EN2591-304 standards
 Salt spray resistance : 48h

ELECTRICAL

Withstanding voltage at sea level and 23 000 meters :
 1 500 V eff. 50 Hz
 Insulation resistance : ≥ at 5 000 MΩ
 Contact resistance : size 22 : 5 mΩ
 size 20 : 4 mΩ
 size 16 : 3 mΩ
 size 12 : 2 mΩ
 Max contact current rating : size 22 : 5 A
 size 20 : 7,5 A
 size 16 : 13 A
 size 12 : 23 A
 size 10 : 33 A (P/N : 001104 630 02)
 46 A (P/N : 001104 620 02)

SYSTEME DE REFERENCE

PART NUMBERING SYSTEM

Modules standards / *Standard modules*
 Modules de masse / *Grounding modules*

CONTACTS / CONTACTS

Taille 22 / *Size 22*
 Taille 20 / *Size 20*
 Taille 16 / *Size 16*
 Taille 12 / *Size 12*
 Modules hybrides / *Mixed modules*

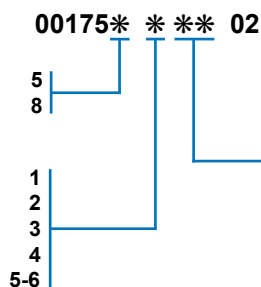

ARRANGEMENTS DES SHUNTS

SHUNTS ARRANGEMENTS

01
 02
 03 - etc...

MODULES 1750 POUR CONTACTS A SERTIR

1750 MODULES FOR CRIMPED CONTACTS



IDENTIFICATION VISUELLE MODULES :

Joint d'étanchéité : **ROUGE** = Fond colmaté

Joint d'étanchéité : **MARRON** = Boîtier

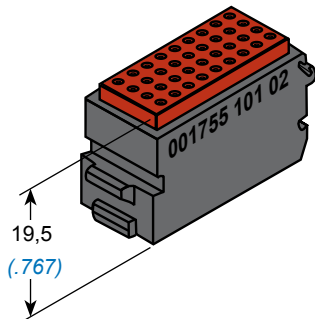

Taille 22
Size 22

36 Contacts
(5 A)

Masse / Weight
16,6 g

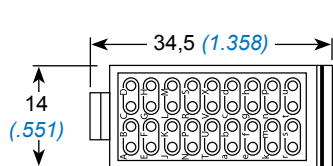

Référence
Part number

001755 101 02

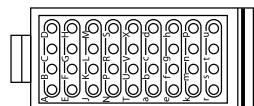

001755 102 02

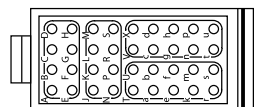

001755 103 02

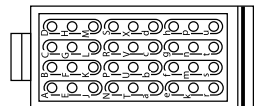

001755 104 02

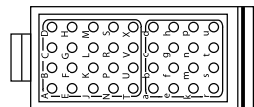

001755 105 02

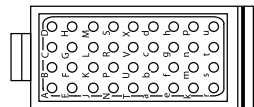

001755 106 02

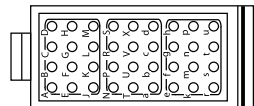

001755 107 02

MODULES VISUAL IDENTIFICATION :

Sealing grommet : **RED** = Sealed bottom

Sealing grommet : **BROWN** = Shell

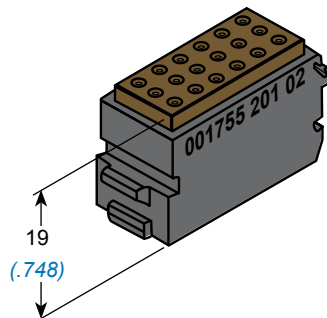

Taille 20
Size 20

18 Contacts
(7,5 A)

Masse / Weight
8,5 g

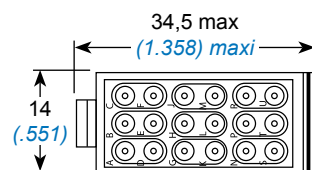

Référence
Part number

001755 201 02

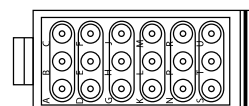

001755 202 02

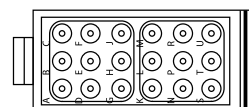

001755 203 02

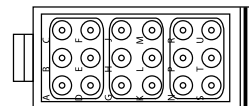

001755 204 02

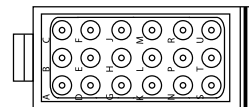

001755 205 02

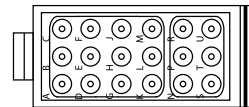

001755 206 02

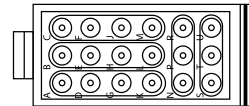

001755 207 02

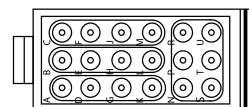

001755 208 02

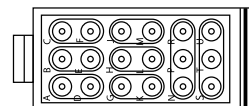

001755 209 02

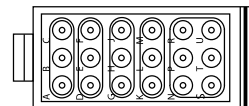

001755 211 02

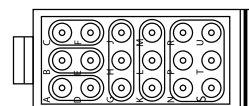

001755 212 02

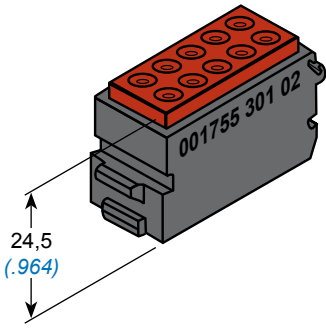

Taille 16
Size 16

10 Contacts
(13 A)

Masse / Weight
18 g

Référence
Part number

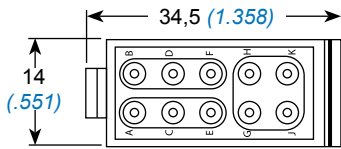

001755 301 02

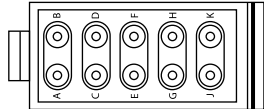

001755 302 02

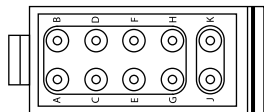

001755 303 02

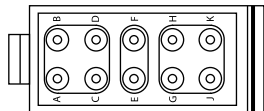

001755 304 02

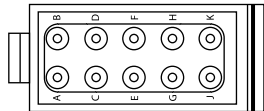

001755 305 02

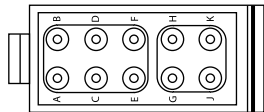

001755 306 02

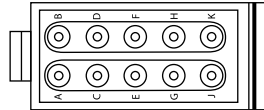

001755 307 02

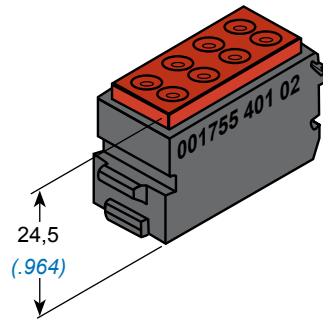

Taille 12
Size 12

8 Contacts
(23 A)

Masse / Weight
19 g

Référence
Part number

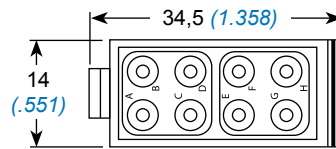

001755 401 02

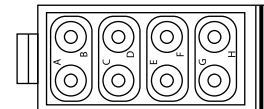

001755 402 02

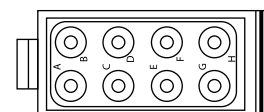

001755 403 02

MODULES HETEROGENES

MIXED MODULES

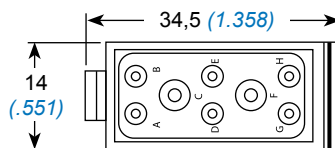
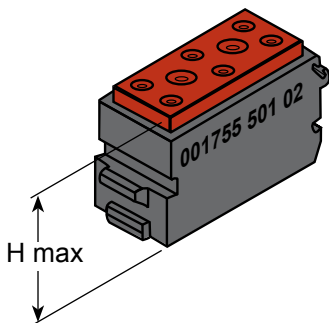

8 Contacts
2 x #12 + 6 x #16
001755 501 02

Masse / Weight
19 g

H : 24,5 (.964)

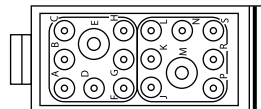

16 Contacts
2 (1 x #12 + 7 x #20)
001755 502 02

Masse / Weight
18 g

H : 24,5 (.964)

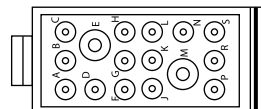

16 Contacts
2 x #12 + 14 x #20
001755 503 02

Masse / Weight
17 g

H : 24,5 (.964)

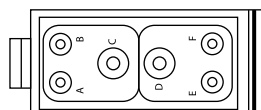

6 Contacts
2 (1 x #12 + 2 x #16)
001755 504 02

Masse / Weight
19 g

H : 24,5 (.964)

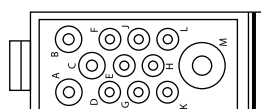

12 Contacts
1 x #10 + 3 x #16 + 8 x #20
001755 601 02

Masse / Weight
19 g

H : 26,2 (1.031)

MODULES DE MASSE 1750

1750 GROUNDING MODULES



A FIXATIONS INDIVIDUELLES

WITH INDIVIDUAL MOUNTING BRACKETS

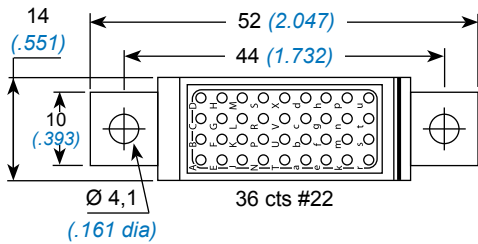

001758 101 02

A : 21,8 (.858)
B : 19,5 (.767)

Masse / Weight
24,0 g

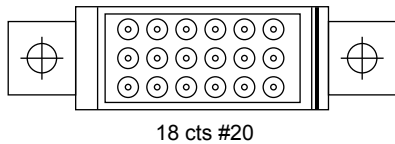
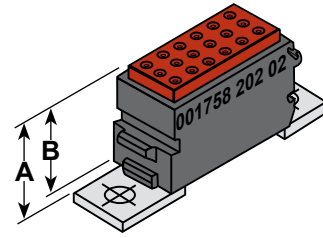

001758 201 02

sans marquage
without markings

A : 24,8 (.976)
B : 22,5 (.885)

Masse / Weight
28,0 g

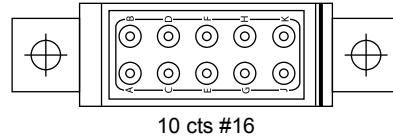

001758 301 02

A : 26,8 (1.055)
B : 24,5 (.964)

Masse / Weight
25 g

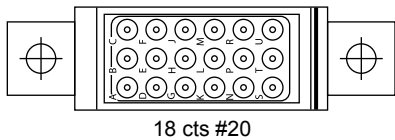

001758 202 02

A : 24,8 (.976)
B : 22,5 (.885)

Masse / Weight
28,0 g

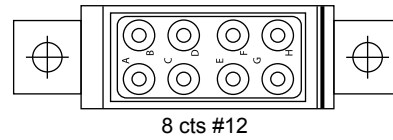

001758 401 02

A : 26,8 (1.055)
B : 24,5 (.964)

Masse / Weight
26 g

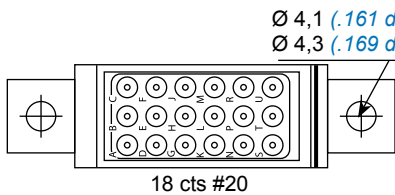

Ø 4,1 (.161 dia) : **001758 212 02**
Ø 4,3 (.169 dia) : **001758 213 02**

A : 24,8 (.976)
B : 19,5 (.767)

Masse / Weight
28,0 g

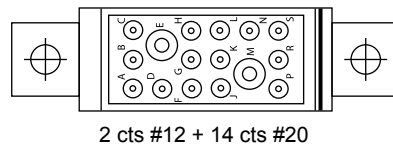

001758 501 02

A : 26,8 (1.055)
B : 24,5 (.964)

Masse / Weight
34 g

SUR RAIL METALLIQUE

ON METALLIC RAIL

Joint d'étanchéité **GRIS**
Sealing grommet **GREY**

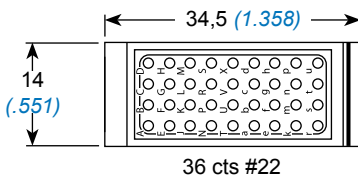

Référence
Part number
001758 120 02

Masse / Weight
17,8 g

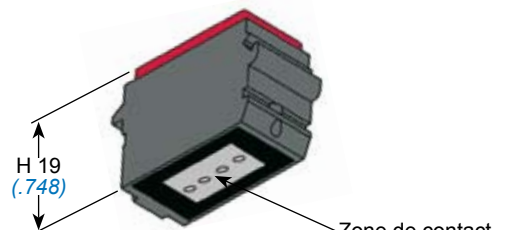

Joint d'étanchéité **ROUGE**
Sealing grommet **RED**

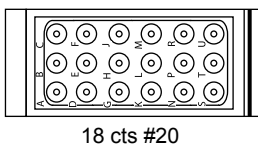

Référence
Part number
001758 220 02

Masse / Weight
17,8 g

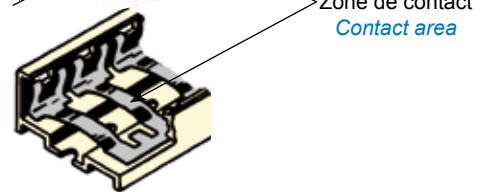

Avec ce module utiliser le rail métallique à revêtement cadmié bichromaté (page 97).

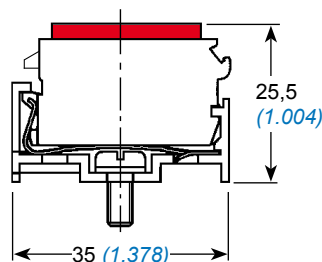

Use the metallic dichromated cadmium plated rail with this module (page 97).

- Monter le module en vis à vis de la fixation
- Ne pas juxtaposer ce type de module
- Laisser au minimum 3 pas de module

- Insert the module facing the module locking device
- Do not mount module side by side
- leave at least a space for three modules between two grounding modules

MODULE 1750 A PIQUER SUR C.I. STRAIGHT PCB SOLDER 1750 MODULE



Taille 20
Size 20

18 Contacts

001750 271 02

Masse / Weight
16 g

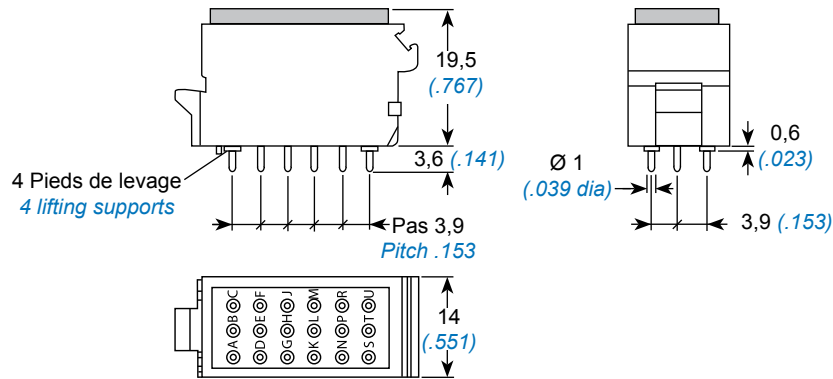

MODULES 1750 A DIODES INSEREES 1750 MODULES WITH INSERTED DIODES

Module étanche avec 3 diodes insérées en D1-D2-D3 (fig.1)

Sealed modules with three inserted diodes D1-D2-D3 (fig.1)

Les diodes sont reliées séparément entre deux séries de contacts à jonctions rapides taille 20.

Diodes are separately joined between two series of fast connection contacts size 20.

Les contacts femelles sont en alliage de laiton protégé or sur nickel, il sont communs par paire, ils servent d'arrivée en S1-S3-S5 et de départ en S2-S4-S6 (fig 1).

Female contacts are plated with gold and nickel alloy. They are arranged in pairs for input in S1-S3-S5 and output in S2-S4-S6 (fig 1).

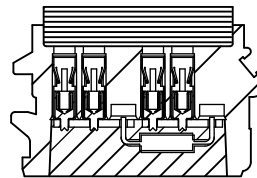
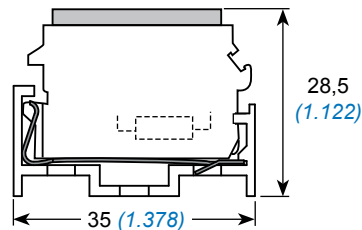
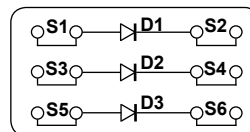
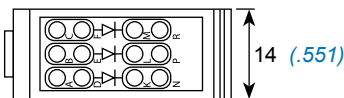

Fig. 1



CARACTERISTIQUE DIODE / DIODE CHARACTERISTICS		REFERENCE / PART NUMBER	
Courant transitoire maximal Maximum transitional current I_o	Tension inversée Inverse voltage VRM	DIODE	MODULE Diode insérée Inserted diode
$I_o = 1 \text{ A}$ à 25°C	VRM = 600 V	JAN 1 N 3613	001765 901 02
$I_o = 1 \text{ A}$ à 140°C	VRM = 800 V	1 N 5621	001765 902 02
$I_o = 75 \text{ mA}$ à 25°C	VRM = 75 V	1 N 4148	001765 903 02
$I_o = 1 \text{ A}$ à 85°C	VRM = 800 V	PL 8 HZ	001765 904 02
$I_o = 1 \text{ A}$ à 140°C	VRM = 400 V	1 N 5617	001765 905 02
$I_o = 1 \text{ A}$ à 75°C	VRM = 1000 V	1 N 4007	001765 906 02
$I_o = 1 \text{ A}$ à 50°C	VRM = 1600 V	EM 513	001765 907 02
$I_o = 1 \text{ A}$ à 25°C	VRM = 600 V	JAN TX 1 N 3613/3614	001765 909 02
$I_o = 4 \text{ A}$	VRM = 400 V	UT 4040	001765 916 02

Autres diodes, merci de nous consulter

For other diodes, please consult us.

MODULES 1750 A TIGE

1750 STUD MODULES



Blocs de jonction de puissance qui se juxtaposent aux modules
(pas 14 mm).

Recommandation : à monter sur rail métallique (page 97).

Power junction block mounted adjacent to modules (pitch of .551 inch).

Metallic rail recommended (page 97).

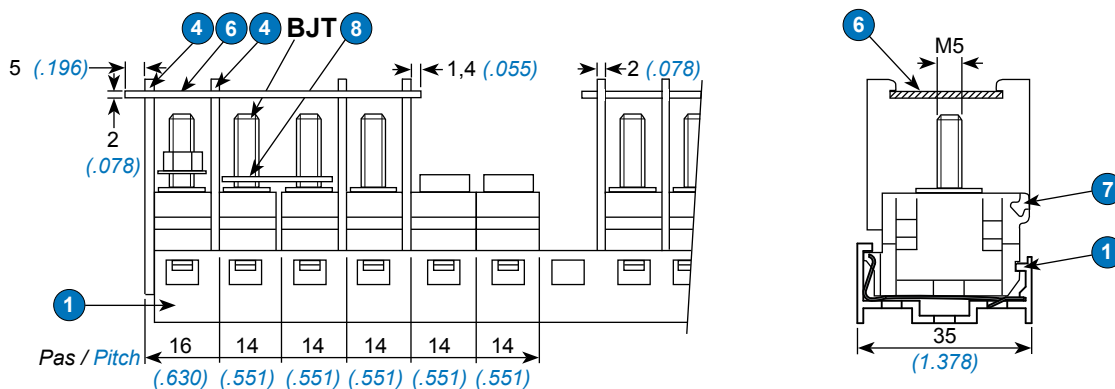

4 SEPARATEUR SEPARATOR	8 SHUNT	6 CAPOT COVER
	<p>Laiton nickelé Brass nickel</p>	<p>L = en fonction du nombre de BJT L = depending on the number of BJT</p>

Matière isolante : EPOXY
(-55°C + 175°C)

Borne : acier inox
Terminal : stainless steel

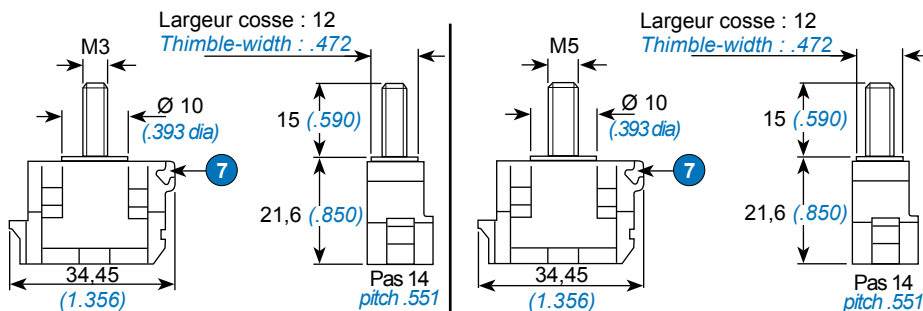

BJT		M3		M5	
Référence / Part Number		001760 933 56		001760 935 56	
Ecrou + rondelle / Nut + washer		000842 030 60		000842 050 60	
Masse g (BJT + Ecrou) Weight g (BJT + nut)		13,5 (.531)		14,8 (.582)	
Couple de serrage / Torque mdaN		0,07		0,25	
CARACTERISTIQUES / DATA		NFC - UTE	DIN - VDE	NFC - UTE	DIN - VDE
Section nominale / Nominal section		2,5 mm ²		14 à / to 21 mm ²	
Tension Voltage	V	~	500 V	500 V	750 V
		-	600 V	800 V	750 V
Intensité / Current	A	20		60	
MONTAGE / MOUNTING					
1	Rail métallique / Metallic Rail	page 97			
4	Séparateur / Partition plate	001761 000 56			
6	Capot / Cover	001761 1** 39			
7	Repère BJT / BJT Ident	page 101			
8	Shunt	/		001762 00* 04	

2 à 5 trous 2 to 5 holes

REFERENTIEL

PART NUMBERING TABLE



Réf / P/N AALBF	Réf / P/N OTAN	Page
000842 030 60		13
000842 050 60		13
001750 271 02		12
001755 101 02	5940144088803	9
001755 102 02	5940144088804	9
001755 103 02	5940144088805	9
001755 104 02	5940144088806	9
001755 105 02	5940144088807	9
001755 106 02		9
001755 107 02		9
001755 201 02	5940144088825	9
001755 202 02	5940144088808	9
001755 203 02	5940144088809	9
001755 204 02	5940144088810	9
001755 205 02	5940144088811	9
001755 206 02	5940144088812	9
001755 207 02	5940144088813	9
001755 208 02		9
001755 209 02		9
001755 211 02		9
001755 212 02	5940144088814	9
001755 301 02	5940144088815	10
001755 302 02	5940144088816	10
001755 303 02	5940144088817	10
001755 304 02	5940144088818	10
001755 305 02	5940144088819	10
001755 306 02	5940144088820	10
001755 307 02		10
001755 401 02	5940144088821	10
001755 402 02	5940144088822	10
001755 403 02	5940144088823	10
001755 501 02	5940144088829	10

Réf / P/N AALBF	Réf / P/N OTAN	Page
001755 502 02	5940144088830	10
001755 503 02	5940144088831	10
001755 504 02		10
001755 601 02		10
001758 101 02		11
001758 120 02		11
001758 201 02	5940144088834	11
001758 202 02	5940144088835	11
001758 212 02		11
001758 213 02		11
001758 220 02		11
001758 301 02		11
001758 401 02		11
001758 501 02		11
001760 933 56		13
001760 935 56	5940144088836	13
001761 000 56		13
001761 1** 39	59401440888**	13
001762 00* 04		13
001765 901 02	5940144088844	12
001765 902 02		12
001765 903 02		12
001765 904 02		12
001765 905 02		12
001765 906 02		12
001765 907 02		12
001765 909 02		12
001765 916 02		12

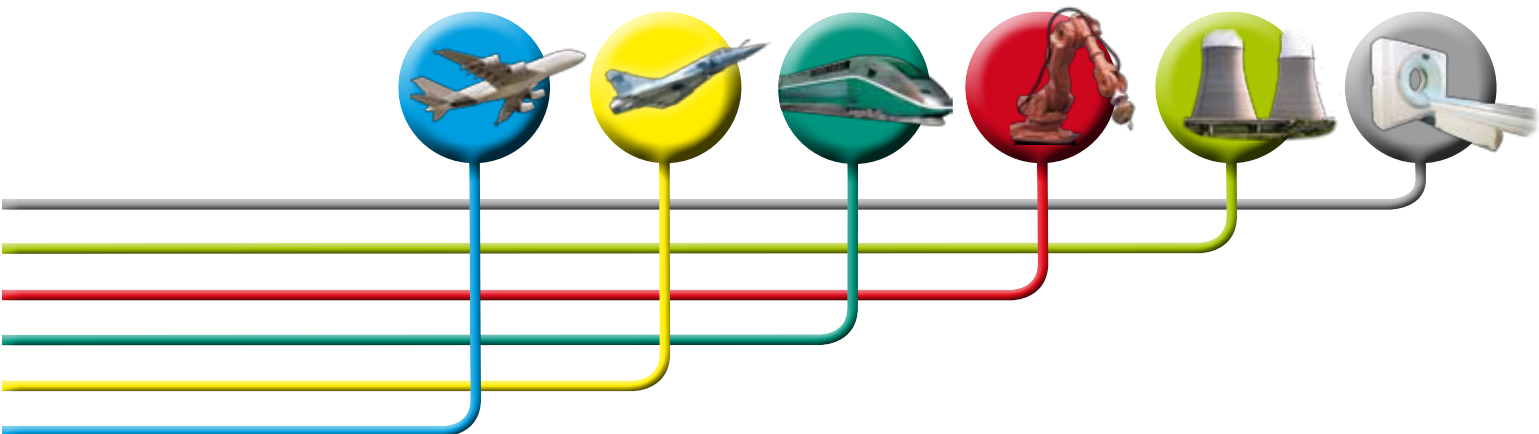

Modules 1765 Porte-Composants

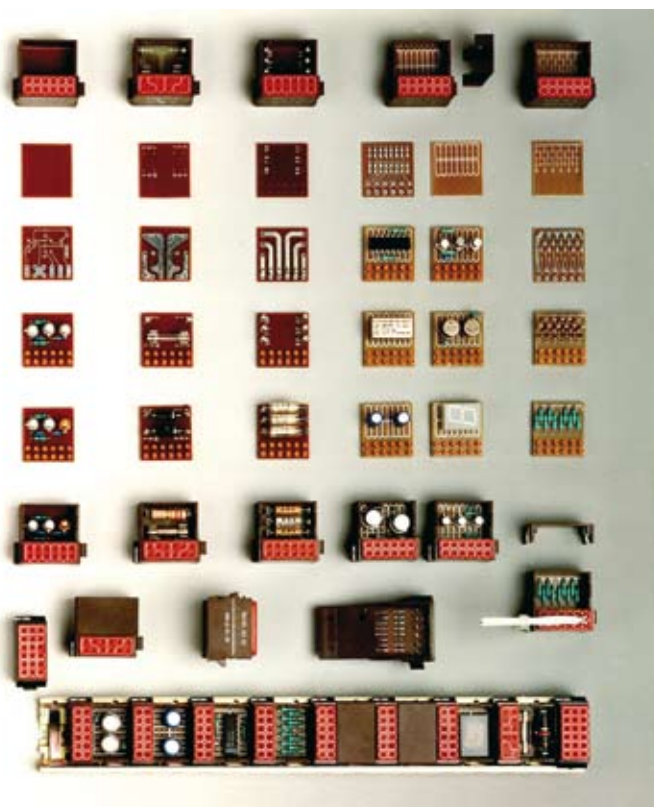

1765 Component Carrier Modules

Edition 05/12

Amphenol Air LB

SYSTEMES DE CONNEXIONS ELECTRIQUES ET ELECTRONIQUES
ELECTRIC AND ELECTRONIC CONNECTION SYSTEMS

PRESENTATION

PRESENTATION



Les modules porte-composants électroniques 1765 constituent une évolution et complètent la gamme des modules à jonctions rapides. Comme le type 1750, ils se montent par encliquetage sur le même rail, ils se juxtaposent aux modules et prennent la place de 2 modules (pas 28 mm).

Ils sont constitués d'une partie connexion à jonctions rapides étanches pour contacts mâles (P) à sertir taille 20 et d'un boîtier porte-composants.

Les composants peuvent être fixés à l'aide de plots à souder, de pinces porte-fusibles, ou piqués et soudés directement sur le C.I. Les composants placés dans le boîtier sont protégés par un capot et peuvent être noyés dans une résine ou une mousse isolante. Plusieurs variantes de C.I. sont disponibles et permettent une multitude de fonctions représentées à titre d'exemple page 16.

- **C.I. à souder spécifique, connexions multiples.**
(Transistors, résistances, diodes, optocoupleur, etc.).
- **C.I. à plots à souder pour 2 composants.**
(Avec ou sans pince porte-fusible).
Connexion : 3 entrées - 3 sorties par composant.
(Diodes, résistances, fusibles, etc.).
- **C.I. à plots à souder pour 3 composants.**
Connexions : 2 entrées - 2 sorties par composant.
(Diodes, condensateurs, résistances, etc.).
- **C.I. à souder au pas de 2,54 mm².**
(Circuits intégrés, résistances, transistors, diodes, relais, condensateurs afficheur 7 segments, etc.).
- **C.I. à souder avec une piste commune.**
(Test lampes). (E4 : 11 résistances + 11 diodes - E5 : 11 résistances ou 11 diodes).

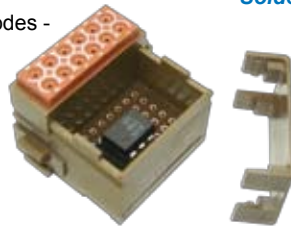

Electronic component carrier modules 1765 represent a significant technical development and complete the quick junction modules range. Like the 1750 type module, they snap on the same rail side by side and take the space of two modules (pitch of 1.102). They consist of sealed quick junction connection for male crimp contacts (P) size 20 and a component carrier housing.

Components may be mounted by means of solder pads, fuse-holder clamps, and inserted or welded directly on PCB. A cover protects components in the housing and they may be further protected in resin or insulating foam. Several PCB variants are available and allow a multitude of functions. See examples on page 16.

- **Solder PCB with multiple connections.**
(Transistors, resistors, diodes, optocoupler, etc.)
- **Solder PCB pads for 2 components**
(with or without fuse-holder clamp)
Connections: 3 inputs and 3 outputs per component (Diodes, resistors, fuses, etc.)
- **Solder PCB pads for 3 components**
Connections: 2 inputs and 2 outputs per component (Diodes, capacitors, resistors, etc.).
- **Solder PCB with a pitch of 2,54 mm²**
(Integrated circuit, resistors, transistors, diodes, relays, 7 segment display capacitors, etc.).
- **Solder PCB with a common track.**
(Test lamps). (E4 : 11 resistors + 11 diodes - E5 : 11 resistors or 11 diodes).

CARACTERISTIQUES TECHNIQUES

TECHNICAL DATA

MECANIQUE

Module	Matière	: Thermoplastique
Joint	Matière	: Elastomère silicone
Contact	Matière	: Alliage cuivreux
	Protection	: Or sur nickel
Vibrations		: Norme MIL-STD-810 D méthode 514-3 Catégorie 6.
Rétention contacts		: taille 20 : 9 daN

CLIMATIQUE

Température d'utilisation	: -55°C à +175°C (hors composants*)
Chaleur humide	: Norme MIL-STD-202 méthode 106

ELECTRIQUE

Tension de tenue (hors Circuit Imprimé) :	
au niveau de la mer	: taille 20 : 1 500 V eff. 50 Hz
12 000 mètres	: taille 20 : 1 000 V eff. 50 Hz
Résistance d'isolement	: ≥ à 5 000 MΩ
Résistance de contacts	: taille 20 : 4 mΩ
Intensité maxi du contact	: taille 20 : 7,5 A suivant schéma

* Tenir compte des caractéristiques techniques des composants utilisés sur le circuit imprimé.

MECHANICAL

Module	Material	: Thermoplastic
Grommet	Material	: Silicone elastomer
Contact	Material	: Copper alloy
	Plating	: Gold on nickel
Vibrations		: Standard MIL-STD-810 D method 514-3 Category 6.
Contact retention		: size 20 : 9 daN

ENVIRONMENT

Operating temperature	: -55°C to +175°C (component not included*)
Damp heat	: Standard MIL-STD-202 method 106

ELECTRICAL

Dielectric withstanding voltage (PCB excluded) :	
at sea level	: size 20 : 1 500 V RMS 50 Hz
12 000 meters	: size 20 : 1 000 V RMS 50 Hz
Insulation resistance	: ≥ to 5 000 MΩ
Contact resistance	: size 20 : 4 mΩ
Max. contact current rating	: size 20 : 7,5 A according to layout

* Take into account the technical data of the components used on the PCB.

MODULES 1765 A COMPOSANTS SOUDES SUR CI 1765 MODULES WITH COMPONENTS SOLDERED ON PCB

Côté inférieur

Référence - **SUFFIXE 02** : module muni d'un C.I., le tiroir inférieur **1** démonté. Module à composer.

Référence - **SUFFIXE 99** : module entièrement équipé, C.I. et tiroir monté indémontable.

Les composants sont soudés côté tiroir inférieur **(c)**. Le tiroir est ensuite inséré par encliquetage indémontable **(e)**.

Le couvercle supérieur **2** se pose et se dépose facilement par insertion-extraction.

Encombrement disponible du logement pour composants :
H : 10,5 mm x L : 24 mm x l : 16,5 mm

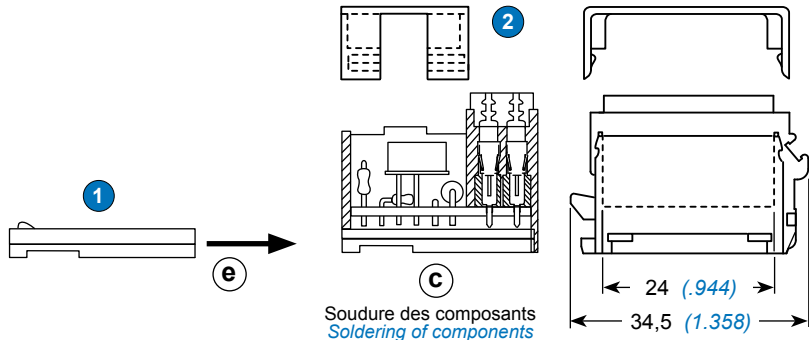
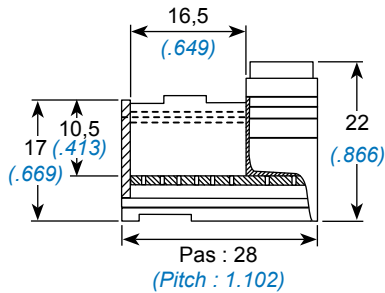

Lower side

Part Number - **SUFFIX 02** : Module equipped with PCB, lower drawer **1** being removed. Module to be made up.

Part number - **SUFFIX 99** : Module completely equipped, PCB and mounted drawer locked in place.

The components are soldered on the underside of the drawer **(c)**. It is then inserted and locked in place so that it cannot be removed **(e)**. The top cover **2** is easily inserted and extracted.

Available overall dimensions for components :
H : .413 inch x L : .944 inch x l : .649 inch

Tenir compte des caractéristiques techniques des composants utilisés sur le circuit imprimé.

Take into account the technical data of the components used on the PCB.

Liaison électrique Electrical connection	Circuit imprimé C.I. PCB	Module	
		Réf P/N	Masse Weight g
	1 résistance RMB3 294 Ω 1% 3 diodes 1N 4007 1 resistor RMB3 294 Ω 1% 3 diodes 1 N 4007	001765 012 99	17,5
	2 résistances RMB3 332 Ω 1% 2 resistors RMB3 332 Ω 1%	001765 016 99	17,5
	3 résistances RMB5 3,9 Ω 1% 3 resistors RMB5 3,9 Ω 1%	001765 017 99	18,5
	1 diode 1N 4007 1 relais monostable 1 diode 1 N 4007 1 monostable relay C.I. double face Double sided PCB	001765 019 99	23,5

Liaison électrique Electrical connection	Circuit imprimé C.I. PCB	Module	
		Réf P/N	Masse Weight g
2,54 (.1) 	Pas de 2,54 mm Pitch of .100 inch	001765 204 02	13,5
1,9 (.074) 		001765 205 99	13,5
		001765 207 02	13,5

Toutes autres adaptations, merci de nous consulter.

For customized solutions, please consult us.

MODULES 1765 A COMPOSANTS SOUDEES SUR PLOTS 1765 MODULES WITH COMPONENTS SOLDERED ON PADS

Côté supérieur

Module entièrement équipé, C.I. et tiroir inférieur ① montés indémontables.

- Ⓐ avec plots à souder ⓐ
- Ⓑ avec plots à souder et pinces porte-fusible ⓑ

Upper side

Module completely equipped with lower drawer ① locked in place.

- Ⓐ with solder pads ⓐ
- Ⓑ with solder pads and fuse holder clamps ⓑ

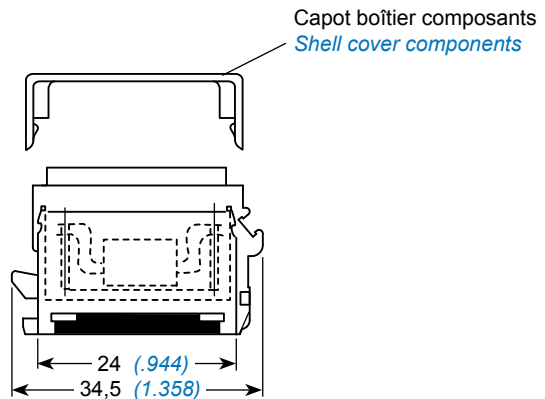
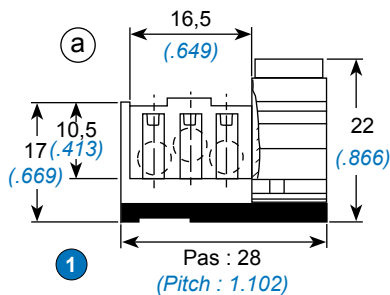

Tenir compte des caractéristiques techniques des composants utilisés sur le circuit imprimé.

Take into account the technical data of the components used on the PCB.

Liaison électrique Electrical connection	Circuit imprimé C.I. PCB				Module	
	2 plots 2 pads ⓐ	Fusible Fuse ⓑ	Connexion Connection Entrée Input / Sortie Output		Référence Part number	Masse Weight g
	3	-	3 x 2	3 x 2	001765 201 02	17,0
	2	-			001765 202 02	16,5
	1	1	2 x 3	2 x 3	001765 206 02	16,5
	-	2			001765 203 02	16,5

Composants non livrés avec les modules
Pour une livraison avec composants, nous consulter

Components are not supplied with the modules
To be delivered with components, please consult us

REFERENTIEL

PART NUMBERING TABLE



Réf / P/N AALBF	Réf / P/N OTAN	Réf / P/N NSA	Page
001765 012 99		ASNE 0598	18
001765 016 99			18
001765 017 99			18
001765 019 99			18
001765 201 02	59401440301332		19
001765 202 02	59401440301333		19
001765 203 03			19
001765 204 02	59401440301337		18
001765 205 99			18
001765 206 02			19
001765 207 02			18

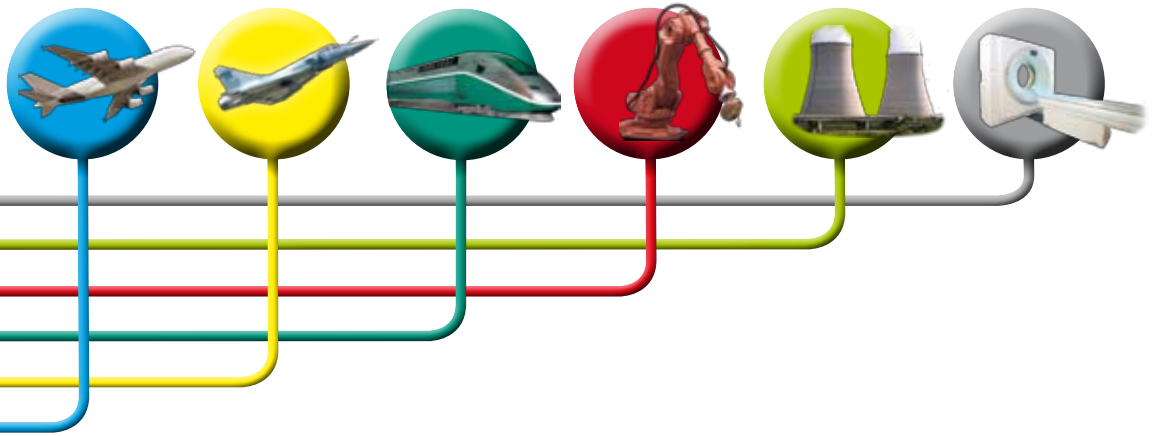

Modules 1767 PA

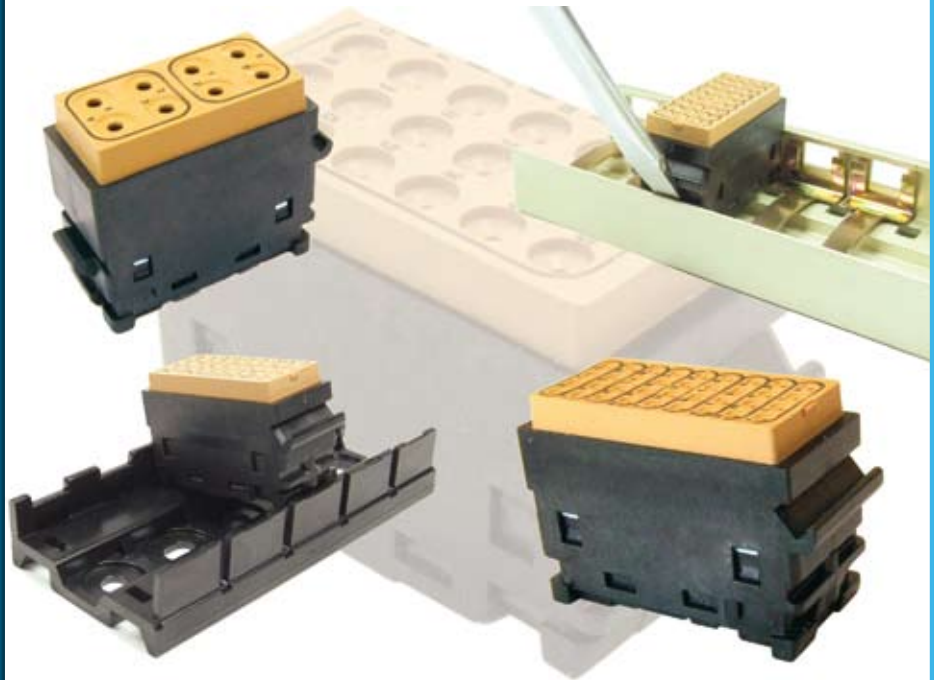

1767 PA Modules

Edition 05/12

Amphenol Air LB

SYSTEMES DE CONNEXIONS ELECTRIQUES ET ELECTRONIQUES
ELECTRIC AND ELECTRONIC CONNECTION SYSTEMS

PRESENTATION

PRESENTATION



Grâce à leur procédé unique de verrouillage, les modules de distribution 1767 PA sont les plus avancés dans la famille des modules à jonction rapide étanches.

Le verrouillage des modules type 1767 PA à sécurité d'enfichage élimine tous les risques de contacts aléatoires en utilisation, permet de diminuer les efforts d'insertion et de supprimer les tractions de contrôle de rétention sur les câbles insérés.

En barrettes, ils offrent des connexions modulaires à très haute densité de câblage, des performances très élevées et une mise en oeuvre rapide et aisée.

Tous les modules sont au pas de 14 mm. Ils se montent en partie ou sur toute la longueur d'un rail métallique dissymétrique muni d'un ressort ou d'un rail composite, et se démontent sans outil spécifique. A chaque instant il est possible de changer un module sans intervenir sur ses voisins.

Le module type 1767 PA à sécurité d'enfichage est complètement interchangeable avec le module type 1750, il utilise les mêmes outillages et les mêmes contacts.

Hormis la mise en oeuvre du module type 1767 PA, les caractéristiques techniques sont conformes à la norme NF/UTE C 93-462 .

Eléments clés du 1767 PA

- Sécurité de verrouillage.
- Câblage à très haute densité avec outils standards.
- Contacts à sertir tailles 22, 20 et 12 pour des gauges de 26 à 12 AWG, normalisés NF L 53-105 NAS 1749 EN3155-016.
- Modules assemblés par encliquetage sur le rail, démontés sans outil spécifique.
- Performances d'étanchéité assurées par un procédé de sur-moulage breveté.
- Identification individuelle des cavités de contacts par marquage sur le grommet.
- Périmètres des contacts shuntés marqués par des lignes noires sur le grommet.
- Arrangements de contacts variés.
- Rail métallique ou composite.
- Possibilité de combinaisons sur le même rail avec des modules à retour, des modules hétérogènes, des modules à diodes ou autres composants insérés, et des bornes de jonctions à tige (puissance).
- Chaque module dispose d'un logement d'étiquette pour un meilleur repérage.

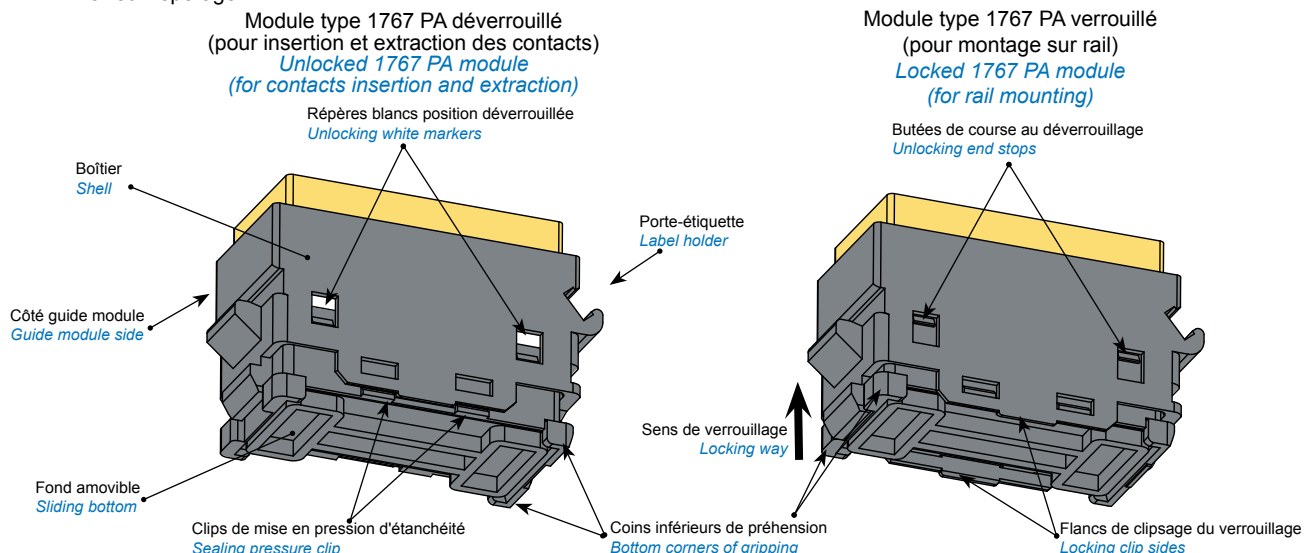

Thanks to their unique Positive Locking feature, the 1767 PA distribution modules are the most advanced Sealed Quick Connect Junction Modules.

The 1767 PA provides an efficient means of securing that contacts are fully engaged and therefore making obsolete the holding traction control usually applied to every individually wired contact.

Different contacts arrangements of the 1767 PA series can be combined together on the same fixing rail to form a very high density, high performance, and quick and easy to install electrical distribution interconnect.

Each module has the same .551 inch pitch. They can be fixed in multiple numbers onto metal or composite fixing rails. They don't need a specific tool to be removed.

Modules can be replaced at any time without moving any of the adjacent modules.

The 1767 PA are fully interchangeable and can be mixed and combined with the standard 1750 series. Both series use the same rails, contacts and crimping tools.

With the exception of the installation procedure, technical features are identical and conforming to NF/UTE C 93-462.

1767 PA series Key features :

- Positive Locking.
- Very High Density Modular wiring terminated with standard tools.
- Crimp contacts size 22, 20 and 12 suitable for 26 to 12 AWG. Contacts are standard NF L 53-105 NAS 1749 EN3155-016 type.
- Quick Assembly : modules are snapped onto the rails or removed without special tool.
- Sealing performance by means of an overmoulded grommet (patented process).
- Individual identification of contacts cavities by marking on the grommet.
- Group of bussed contacts clearly defined by black lines marking on the grommet.
- Broad range of contact layouts.
- Metallic or composite rail.
- 1767 PA series can be combined onto the same fixing rail with return modules, mixed layout modules, diodes or other components fitted modules, as well as power terminal blocks.
- Each module has a reference tag holder for easier identification.

CARACTERISTIQUES TECHNIQUES

TECHNICAL DATA



MECANIQUE

Boîtier	Matière	: Thermoplastique noir
Joint	Matière	: Elastomère silicone
Contact	Matière	: Alliage cuivreux
	Protection	: Or sur nickel
Endurance		: 10 cycles complets de verrouillage et déverrouillage
Vibrations		: Sinusoïdales fréquence de 10 à 2000 Hz accélération 20 g. 12 cycles, discontinuité ≤ 1 µs
Chocs		: 100 g 1/2 sinus, 6 ms (3 chocs dans 3 directions)
Rétention des contacts		
	taille 22	: 5,3 daN
	taille 20	: 8,9 daN
	taille 12	: 13,6 daN

CLIMATIQUE

Température d'utilisation	: -55° à +175° C
Tenue aux fluides	: conforme à la norme NF C 93-462

ELECTRIQUE

Tension de tenue	: 1500 V eff.
Intensité	: 5 A maxi pour taille 22
	: 7,5 A maxi pour taille 20
	: 23 A maxi pour taille 12

MECHANICAL

Shell	Material	: Black thermoplastic
Seal	Material	: Silicon elastomer
Contact	Material	: Copper alloy
	Plating	: Gold on nickel
Endurance		: 10 complete cycles of locking and unlocking
Vibrations		: Sinusoidal frequency from 10 to 2000 Hz acceleration 20 g. 12 cycles, discontinuity ≤ 1 µs
Shocks		: 100 g 1/2 sinus, 6 ms (3 shocks in 3 directions)
Contacts retention in insulator		
	size 22	: 5,3 daN
	size 20	: 8,9 daN
	size 12	: 13,6 daN

ENVIRONMENT

Operating temperature	: -55°C to +175°C
Fluids resistance	: complies with NFC 93-462 standard

ELECTRICAL

Dielectric withstanding voltage	: 1500 V RMS.
Current rating	: 5 A max for size 22
	: 7,5 A max for size 20
	: 23 A max for size 12

SYSTEME DE REFERENCE

PART NUMBERING SYSTEM

CONTACTS / CONTACTS

Taille 22 / *Size 22*
 Taille 20 / *Size 20*
 Taille 12 / *Size 12*
 Modules hybrides / *Mixed modules*

ARRANGEMENTS DES SHUNTS / SHUNTS LAYOUTS

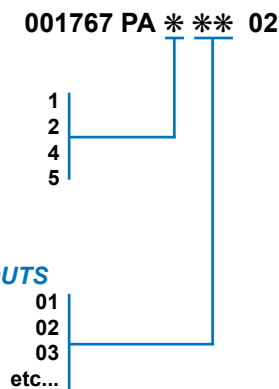

MODULES 1767 PA

1767 PA MODULES



Taille 22 - 36 Contacts
Size 22 - 36 Contacts

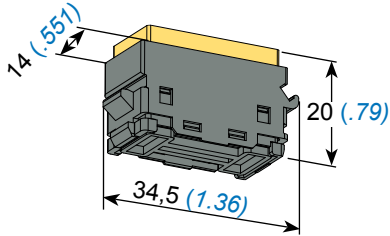

001767 PA 101 02

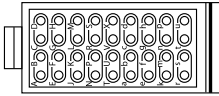

001767 PA 102 02

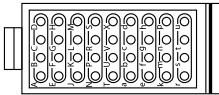

001767 PA 103 02

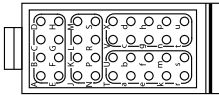

001767 PA 104 02

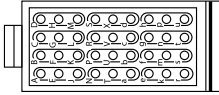

001767 PA 105 02

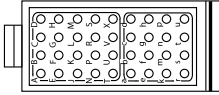

001767 PA 106 02

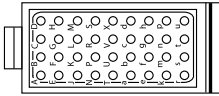

001767 PA 107 02

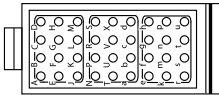

Taille 20 - 18 Contacts
Size 20 - 18 Contacts

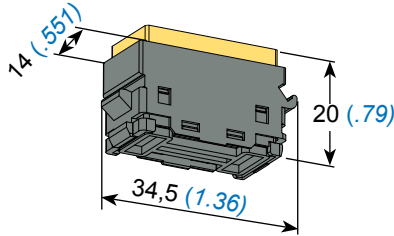

001767 PA 201 02

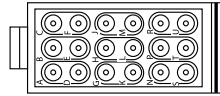

001767 PA 202 02

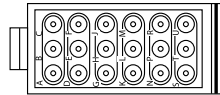

001767 PA 203 02

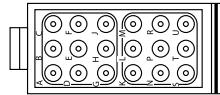

001767 PA 204 02

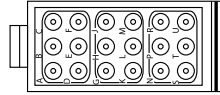

001767 PA 205 02

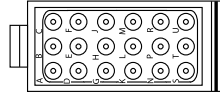

001767 PA 206 02

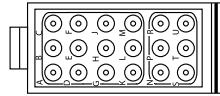

001767 PA 207 02

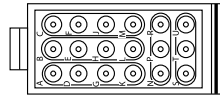

001767 PA 208 02

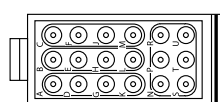

Taille 12 - 8 Contacts
Size 12 - 8 Contacts

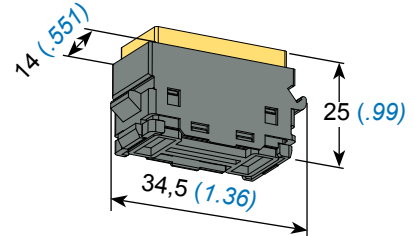

001767 PA 401 02

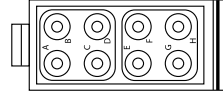

Modules Hybrides
Taille 12 - 2 cts + Taille 20 - 12 cts
Hybrid modules
Size 12 - 2 cts + Size 20 - 12 cts

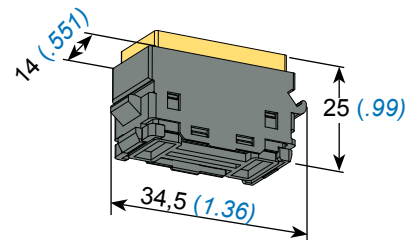

001767 PA 502 02

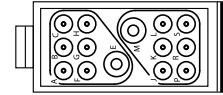

001767 PA 503 02

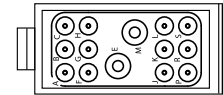

Module de masse
Taille 20 - 18 Contacts
Grounding module
Size 20 - 18 Contacts

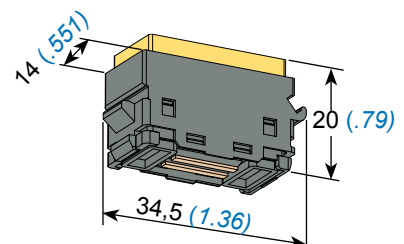

001767 PA 220 02

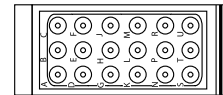

REFERENTIEL

PART NUMBERING TABLE



Réf /P/N AALBF	Page
001767 PA 101 02	25
001767 PA 102 02	25
001767 PA 103 02	25
001767 PA 104 02	25
001767 PA 105 02	25
001767 PA 106 02	25
001767 PA 107 02	25
001767 PA 201 02	25
001767 PA 202 02	25
001767 PA 203 02	25
001767 PA 204 02	25
001767 PA 205 02	25
001767 PA 206 02	25
001767 PA 207 02	25
001767 PA 208 02	25
001767 PA 220 02	25
001767 PA 401 02	25
001767 PA 502 02	25
001767 PA 503 02	25

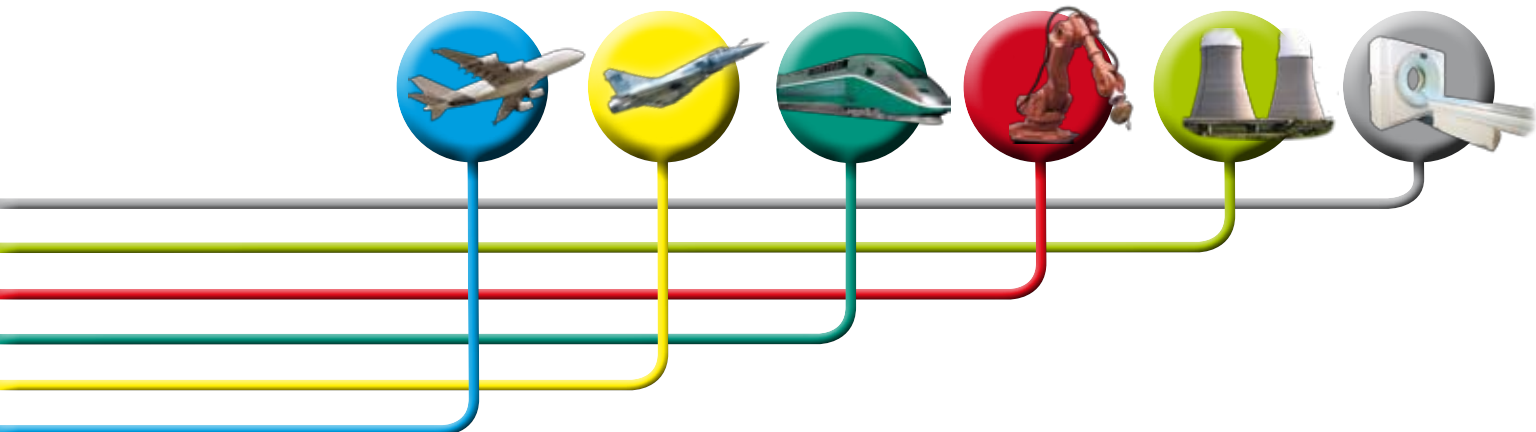

Modules type 1100 et Dérivés

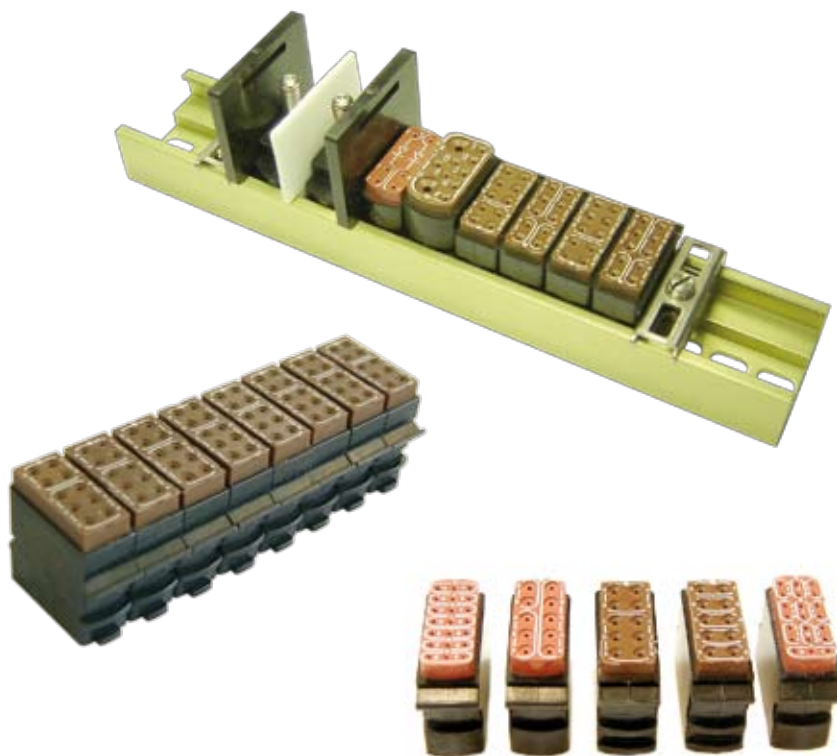

Modules 1100 series and Derived

Edition 05/12

Amphenol Air LB

SYSTEMES DE CONNEXIONS ELECTRIQUES ET ELECTRONIQUES
ELECTRIC AND ELECTRONIC CONNECTION SYSTEMS

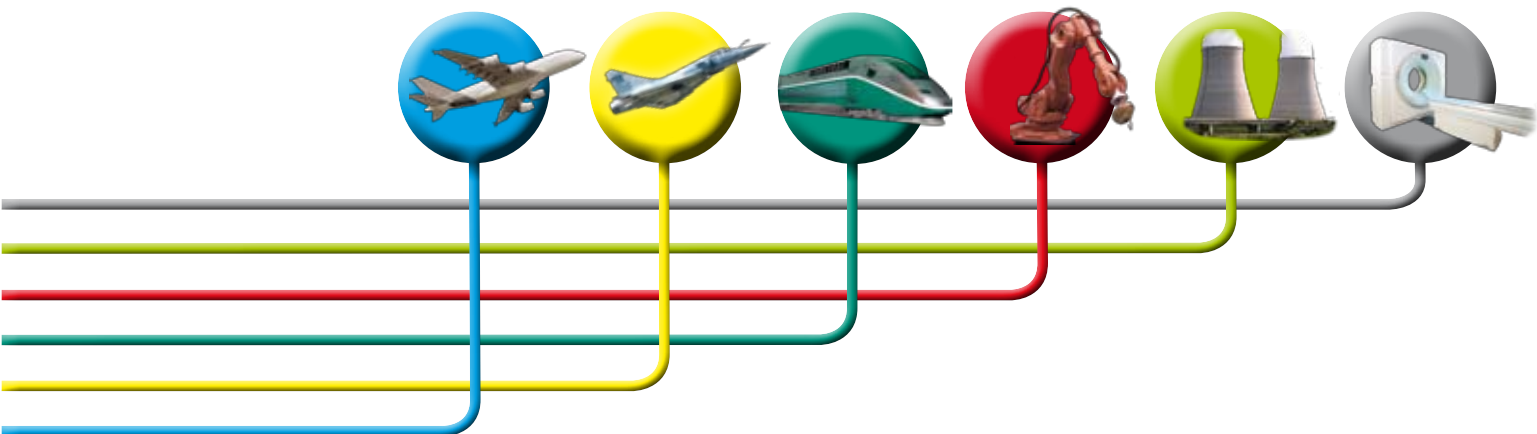

Modules 1100

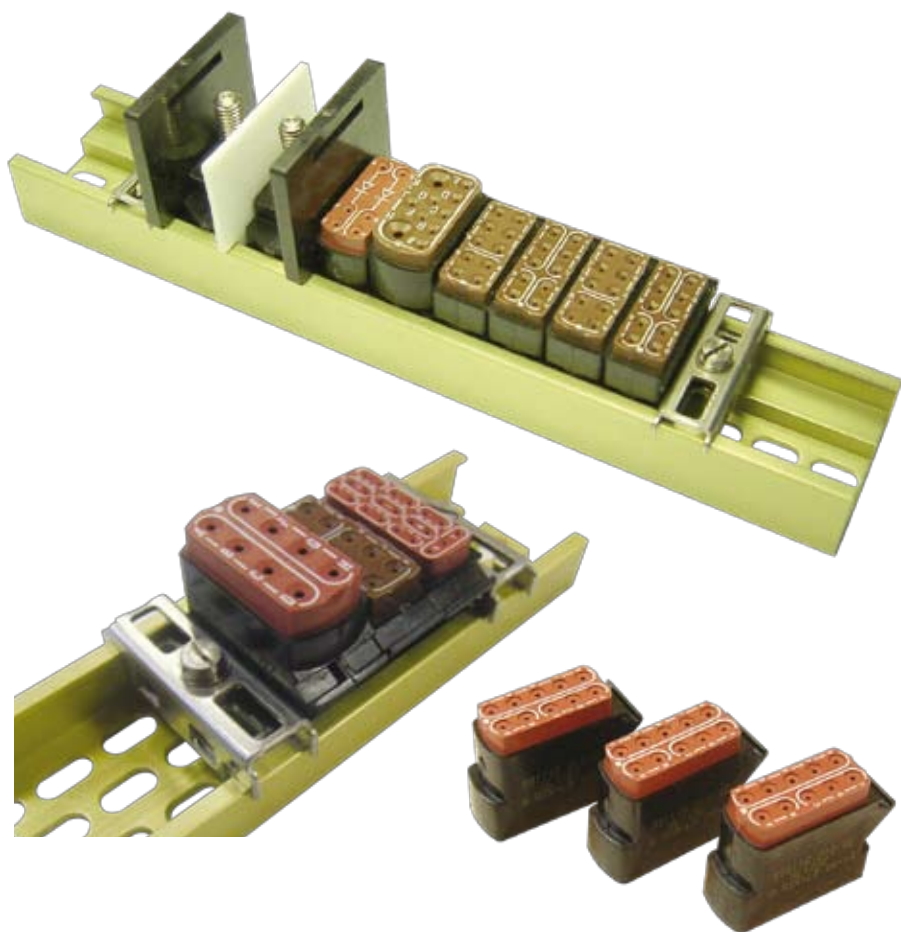

1100 Modules

Edition 05/12

Amphenol Air LB

SYSTEMES DE CONNEXIONS ELECTRIQUES ET ELECTRONIQUES
ELECTRIC AND ELECTRONIC CONNECTION SYSTEMS

PRESENTATION PRESENTATION

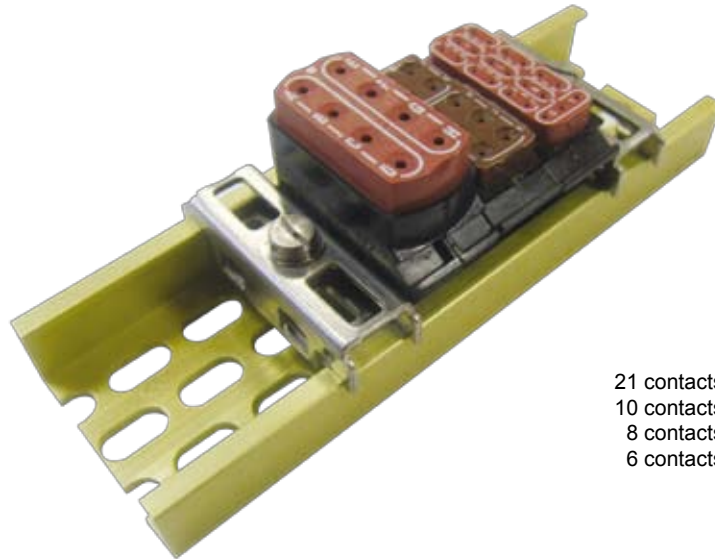

21 contacts - taille / [size 22](#)
10 contacts - taille / [size 20](#)
8 contacts - taille / [size 16](#)
6 contacts - taille / [size 12](#)

Les modules de distribution amovibles **type 1100** sont montés en barrettes par glissement à l'intérieur d'un rail métallique dissymétrique. Ils sont arrêtés aux extrémités par une butée d'arrêt qu'il suffit de déplacer de quelques millimètres pour dégager un module par rotation (page 117).

*Removable distribution modules **type 1100** are mounted on rails by sliding them inside a metal dissymmetrical rail, and maintained each side by an end stop. End stops may be moved a few millimeters to extract a module by rotation (page 117).*

Les modules conviennent à des contacts mâles à sertir (P) normalisés tailles 22-20-16-12 pour des gauges 26 à 12 AWG qui correspondent à des sections de câbles de 0,15 à 3,18 mm².

Modules are suitable for standardized male crimp contacts (P) sizes 22-20-16-12, 26 to 12 AWG corresponding to cable sections from 0.15 to 3.18 mm².

- Modules conformes à la norme **NF/UTE C 93-462, NSA 937901 et EN 3708**
- Contacts mâles à sertir (P), conformes aux normes **NF L53-105, NAS 1749, EN 3155-016** à montage et démontage rapides avec des outils normalisés.
- Deux types de rails métalliques coupés à la demande.
- Grande variété de schémas électriques.
- Modules de masse, à diodes insérées, hétérogènes, à piquer sur C.I.
- Modules et barrettes en traversées.
- Blocs de jonction de puissance munis de bornes à tige Ø5 ou Ø8.
- Blocs de jonction pour fusibles et diodes.
- Montage des modules individuellement.

- *Modules comply with **NF/UTE C 93-462, NSA 937901 and EN 3708** standards*
- *Crimp male contacts (P) comply with **NF L 53-105, NAS 1749 and EN 3155-016** standards. May be inserted or extracted with standard tools.*
- *Two types of metal rails cut to measure.*
- *Large range of wiring diagrams.*
- *Grounding modules with incorporated diodes, mixed modules and modules to be soldered on PCB.*
- *Feedthrough modules and rails.*
- *Power junction blocks with stud terminals Ø5 or Ø8.*
- *Junction blocks for fuses and diodes.*
- *Modules mounted individually.*



Le type 1100 conçu et réalisé par Amphenol Air LB a fait l'objet de la norme NF/UTE C93-462
Type 1100 designed and manufactured by Amphenol Air LB was subject of NF/UTE C93-462 Standard

CARACTERISTIQUES TECHNIQUES TECHNICAL DATA



MECANIQUE

Module	Matière	: Thermoplastique
Joint	Matière	: Elastomère silicone
Contact	Matière	: Alliage cuivreux
	Protection	: Or sur nickel
Vibrations		: Sinusoïdales fréquence de 10 à 2000 Hz accélération 10 g. 12 cycles, discontinuité ≤ 1 µs
Endurance		: 10 cycles de montage/démontage du contact dans cavité
Chocs		: 100 g 1/2 sinus, 6 ms (3 chocs dans 3 directions)
Rétention contacts	taille 22	: 4 daN
	taille 20	: 6 daN
	tailles 16 et 12	: 11 daN

RESISTANCE AUX FLUIDES

Tenue aux fluides : Conforme aux normes EN 3708

CLIMATIQUE

Température d'utilisation	: -55°C à +175°C
Endurance	: 1000h à 175°C
Chaleur humide	: 21j à 40°C et 93% HR
Résistance au Brouillard Salin	: 48h

ELECTRIQUE

Tension de tenue :	
au niveau de la mer	: toutes tailles, tous modules : 1500 V rms
21 000 mètres	: 350 V
Résistance d'isolement	: ≥ à 5 000 MΩ
Résistance de contacts	: taille 22 : 5 mΩ
	taille 20 : 4 mΩ
	tailles 16, 12 : 3 mΩ
Intensité maxi du contact	: taille 22 : 5 A
	taille 20 : 7,5 A
	taille 16 : 13 A
	taille 12 : 23 A

MECHANICAL

Module	Material	: Thermoplastic
Grommet	Material	: Silicon elastomer
Contact	Material	: Copper alloy
	Plating	: Gold on nickel
Vibrations		: Sinusoidal frequency from 10 to 2000 Hz acceleration 10 g. 12 cycles, discontinuity ≤ 1 µs
Endurance		: 10 complete mounting/unmounting cycles of contacts into the cavity
Shocks		: 100 g 1/2 sinus, 6 ms (3 shocks in 3 directions)
Contact retention	size 22	: 4 daN
	size 20	: 6 daN
	sizes 16 et 12	: 11 daN

RESISTANCE TO FLUIDS

Fluids resistance : Complies with standards EN 3708

ENVIRONMENT

Operating temperature	: -55° to +175°C
Endurance	: 1000h à 175°C
Damp heat	: 21j à 40°C et 93% HR
Salt spray resistance	: 48h

ELECTRICAL

Withstanding voltage :	
at sea level	: all sizes, all modules : 1500 V rms
21 000 meters	: 350 V
Insulation resistance	: ≥ at 5 000 MΩ
Contact resistance	: size 22 : 5 mΩ
	size 20 : 4 mΩ
	sizes 16, 12 : 3 mΩ
Max. contact current rating	: size 22 : 5 A
	size 20 : 7,5 A
	size 16 : 13 A
	size 12 : 23 A

SYSTEME DE REFERENCE PART NUMBERING SYSTEM

TYPE DE MODULE / TYPE OF MODULE

Modules standards / <i>Standard modules</i>	15
Modules de masse / <i>Grounding modules</i>	18
Modules a fixation individuelle / <i>single fixing modules</i>	07
Modules à composants / <i>Modules with components</i>	30

CONTACTS / CONTACTS

Taille 22 / <i>Size 22</i>	1
Taille 20 / <i>Size 20</i>	2
Taille 16 / <i>Size 16</i>	3
Taille 12 / <i>Size 12</i>	4
Modules hybrides / <i>Mixed modules</i>	5

ARRANGEMENTS DES SHUNTS / SHUNTS LAYOUTS

01
02
03
etc...

0011** * ** 02

Modules standards / Standard modules :

Avec repérage imprimé	: 001115 *** 02
Sans repérage	: 001105 *** 02
With printing on module	: 001115 *** 02
Without printing on module	: 001105 *** 02

MODULES 1100

1100 MODULES



IDENTIFICATION VISUELLE MODULES :

Joint d'étanchéité : **ROUGE** = Fond colmaté
 Joint d'étanchéité : **MARRON** = Boîtier **J1**

MODULES - VISUAL IDENTIFICATION :

Sealing grommet : **RED** = Sealed bottom
 Sealing grommet : **BROWN** = Shell **J1**

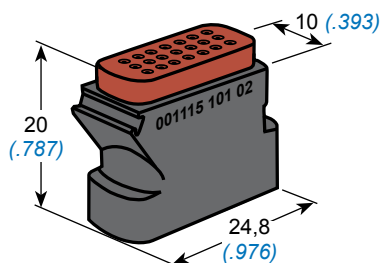

Taille 22
Size 22

21 Contacts
(5 A)

Masse / Weight
8,75 g

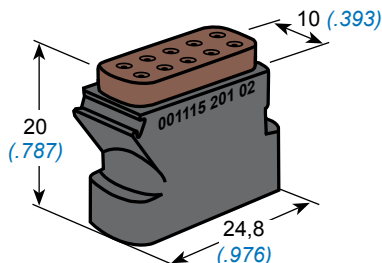

Taille 20
Size 20

10 Contacts
(7,5 A)

Masse / Weight

J1 Rouge Red 6,61 g
Marron Brown 4,85 g

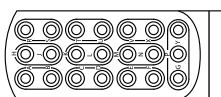

001115 101 02

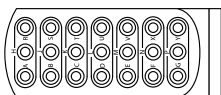

001115 102 02

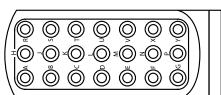

001115 103 02

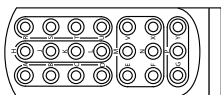

001115 104 02

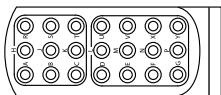

001115 105 02

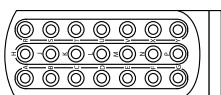

001115 106 02

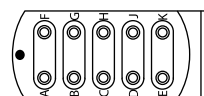

001115 201 02 **J1**

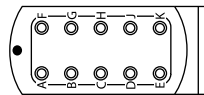

001115 202 02 **J1**

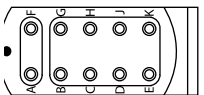

001115 203 02

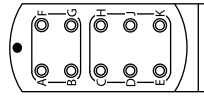

001115 204 02 **J1**

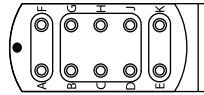

001115 205 02

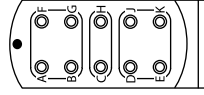

001115 206 02 **J1**

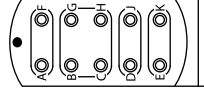

001115 207 02 **J1**

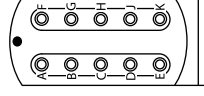

001115 208 02 **J1**

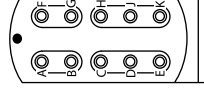

001115 209 02 **J1**

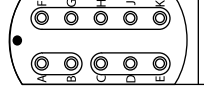

001115 210 02

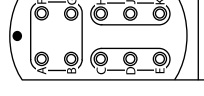

001115 211 02 **J1**

MODULES HETEROGENES MIXED MODULES

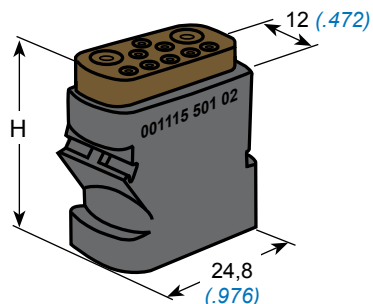

10 Contacts :
2 x 12 + 8 x 20

Masse / Weight
6,8 g

Pas / Pitch : 12 (.472)
H = 22,3 (.877)

001115 501 02 **J1**

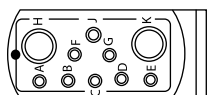

18 Contacts ;
2 x 12 + 4 x 16 + 12 x 20

Masse / Weight
25,50 g

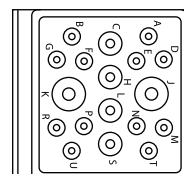

Pas / Pitch : 25 (.984)
H = 23 (.905)

001115 503 02 **J1**

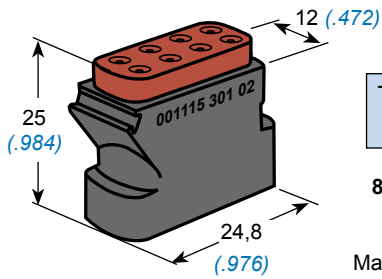

Taille 16
Size 16

8 Contacts
(13 A)

Masse / Weight
12,20 g

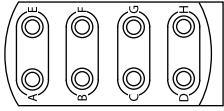

001115 301 02

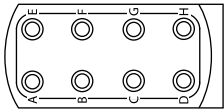

001115 302 02

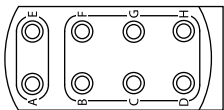

001115 303 02

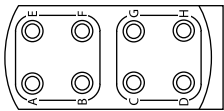

001115 304 02

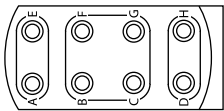

001115 305 02

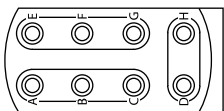

001115 306 02

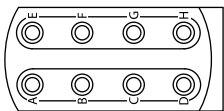

001115 308 02

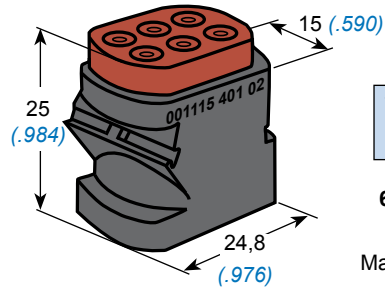

Taille 12
Size 12

6 Contacts
(23 A)

Masse / Weight
15,80 g

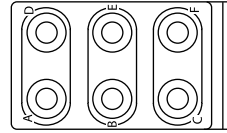

001115 401 02

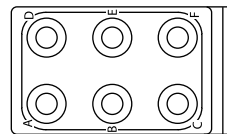

001115 402 02

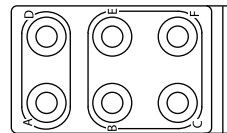

001115 403 02

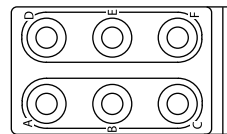

001115 404 02

MODULES DE MASSE 1100 1100 GROUNDING MODULES



A FIXATIONS INDIVIDUELLES

Voir p 36 pour Ensemble module de masse standard
+ Etrier individuel cadmié

WITH INDIVIDUAL MOUNTING BRACKETS

See p.36 for Kit Grounding module + Individual Cadmium plated bracket

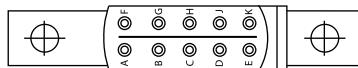
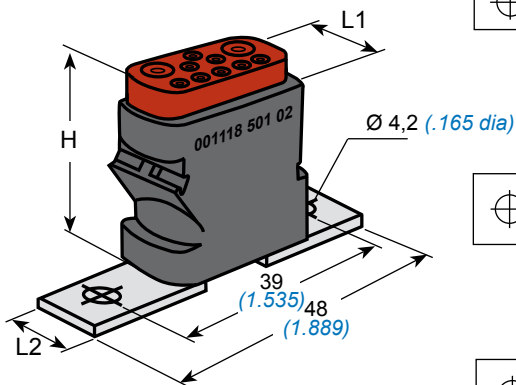

Taille 20
Size 20

10 Contacts

001118 202 02

Masse / Weight
10,5 g

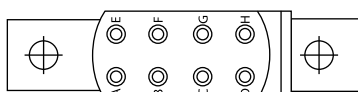

Taille 16
Size 16

8 Contacts

001118 302 02

Masse / Weight
17,5 g

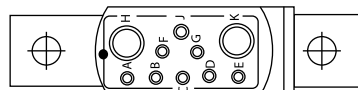

2x12 + 8x20

10 Contacts

001118 501 02

Masse / Weight
16,5 g

L1	H	L2
10 .939	21,5 .846	10 .939
12 .472	27 1.063	9,6 .378
12 .472	27 1.063	10 .939

MODULES 1100 FUTS A SOUDER

1100 SOLDER CUP MODULES



Taille 22
Size 22

21 Contacts
001115 150 02

Masse / Weight
9,40 g

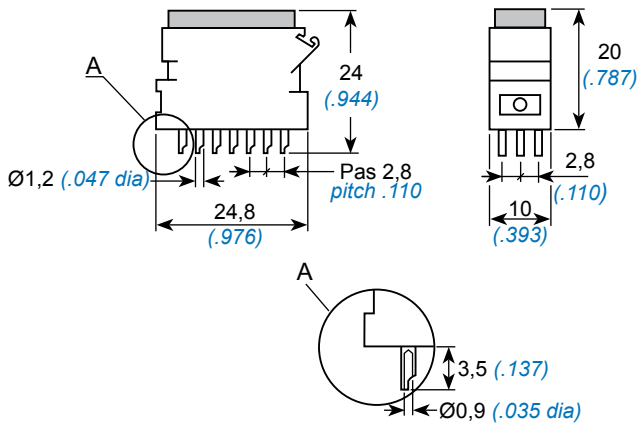

Taille 20
Size 20

10 Contacts
001100 267 02

Masse / Weight
8,60 g

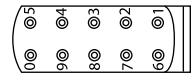
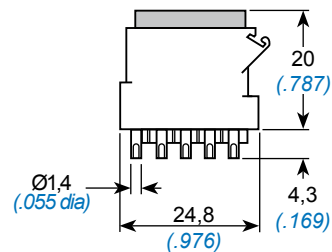

J & D sans contact et sans marquage
J & D neither contact nor identification

001100 264 02

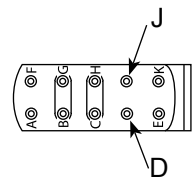

MODULES 1100 A PIQUER SUR CI

STRAIGHT PCB 1100 MODULES

Taille 22
Size 22

21 Contacts
001115 151 02

Masse / Weight
9,40 g

DROIT
STRAIGHT

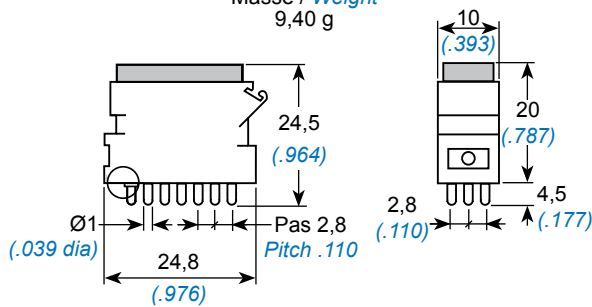

Taille 20
Size 20

10 Contacts
001100 271 02

Masse / Weight
8,40 g

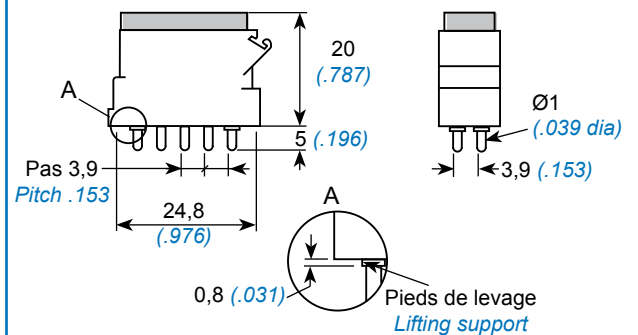

COUDE
RIGHT
ANGLED

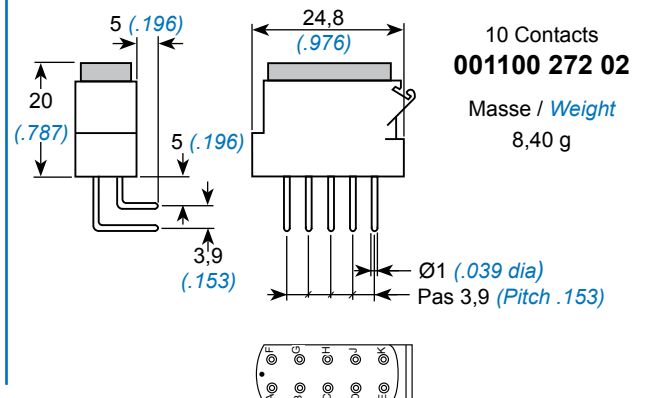

FIXATIONS INDIVIDUELLES

INDIVIDUAL MOUNTING BRACKETS

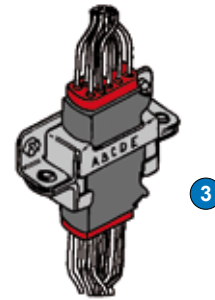
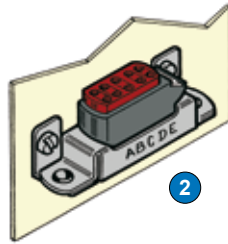
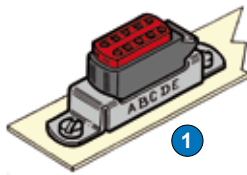

ETRIER DROIT

RIGHT BRACKET

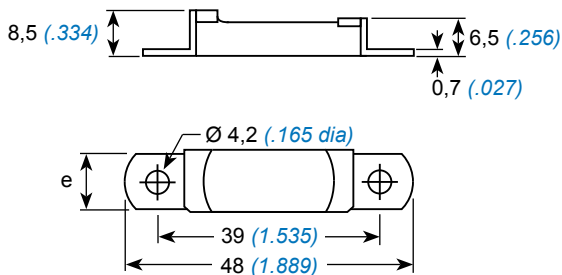

1	Tailles / Sizes 22 - 20			Taille / Size 16		
	e		Référence Part number	e		Référence Part number
	mm	inch		mm	inch	
Acier cadmié Cadmium plated steel	11,5	.452	001107 200 61	13,5	.531	001107 300 61
Acier inox Stainless steel	11,5	.452	001107 200 60	13,5	.531	001107 300 60
Masse / Weight	3,6 g			4,0 g		

ETRIER D'ÉQUERRE

(Toujours livrés avec module)

ANGLE BRACKET

(Always supplied with the module)

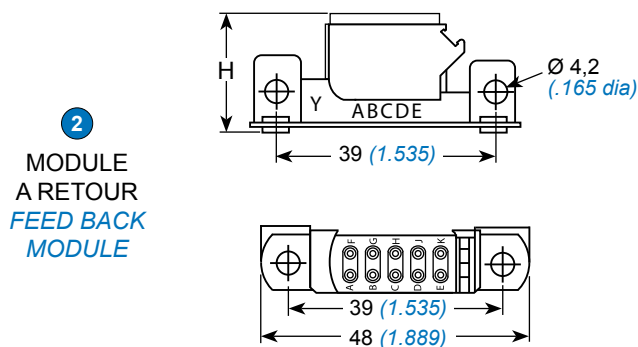

H = module + 2 mm (.078 inch)

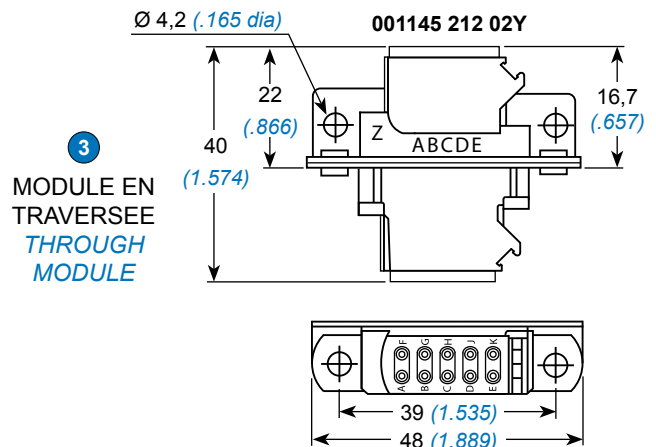

Ref / P/N	Description	
	Module	Fixation / Bracket
001115 201 02Z	Module #20 étanche #20 sealed module	+ Etrier équerre inox Stainless steel plated bracket
001115 209 02Z		
001115 211 02Z		
001115 101 02Y	Module #22 étanche #22 sealed module	+ Etrier équerre cadmié Cadmium plated angled bracket
001115 104 02Y		
001115 105 02Y		
001115 201 02Y	Module #20 étanche #20 sealed module	+ Etrier équerre cadmié Cadmium plated angled bracket
001115 202 02Y		
001115 205 02Y		
001115 209 02Y		
001115 211 02Y		
001115 212 02Y		
001145 201 02Z	Module de traversée # 20 #20 feedthru module	+ Etrier équerre inox Stainless steel plated bracket
001145 212 02Z	Module de traversée # 20 #20 feedthru module	+ Etrier équerre cadmié Cadmium plated angled bracket
001145 201 02Y	Module de traversée # 20 #20 feedthru module	+ Etrier équerre cadmié Cadmium plated angled bracket
001145 212 02Y	Module de traversée # 20 #20 feedthru module	+ Etrier équerre cadmié Cadmium plated angled bracket
001118 202 02Y	Module de masse #20 #20 ground module	+ Etrier équerre cadmié Cadmium plated angled bracket
001118 302 02Y	Module de masse #16 #16 ground module	+ Etrier équerre cadmié Cadmium plated angled bracket

Type 1130

MODULES A DIODES INSEREES MODULES WITH INSERTED DIODES



Montage sur rail

Module étanche composé de 2 diodes insérées en D1 - D2.
Les diodes sont reliées séparément entre deux séries de contacts à jonctions rapides, taille 20 ou taille 16.

Les contacts sont communs par paire, ils servent d'arrivée en S1 - S3 et de départ en S2 - S4.

- Contact taille 20. Câbles 0,21 à 0,93 mm²
Gauge 18-20-22-24 AWG.
- Contact taille 16. Câbles 0,6 à 1,34 mm²
Gauge 16-18-20 AWG

Rail mounting

Sealed module with 2 inserted diodes in D1 - D2.
Diodes are individually connected between 2 series of quick junction contacts size 20 or size 16.

Contacts are in pairs and used for input in S1 - S3 and output in S2 - S4.

- Contact size 20. Cables 0,21 to 0,93 mm²
Gage 18-20-22-24 AWG.
- Contact size 16. Cables 0,6 to 1,34 mm²
Gage 16-18-20 AWG.

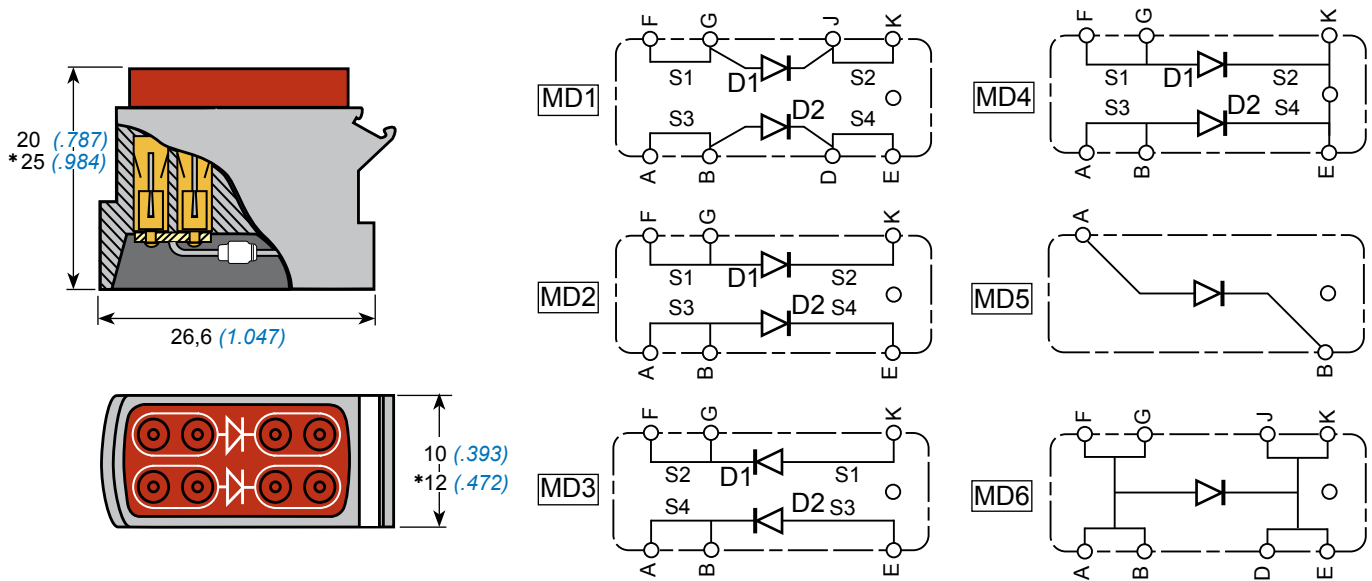

Caractéristiques DIODE <i>DIODE data</i>		REFERENCE <i>PART NUMBER</i>			
Courant transitoire maximal I_o <i>Maximum transitional current I_o</i>	Tension inversée VRM <i>Reverse voltage VRM</i>	Schéma <i>Schematic</i>	DIODE <i>DIODE</i>	MODULE Diode insérée <i>MODULE inserted diode</i>	Taille des contacts <i>Contact size</i>
$I_o = 1 \text{ A à } t_o 25^\circ\text{C}$	VRM = 600 Volts	MD1	JAN 1 N 3613	001130 901 02	#20
$I_o = 1 \text{ A à } t_o 25^\circ\text{C}$	VRM = 1000 Volts	MD2	1 N 5622	001130 902 02	#20
$I_o = 1 \text{ A à } t_o 140^\circ\text{C}$	VRM = 1000 Volts	MD2	1 N 5623	001130 903 02	#20
$I_o = 1 \text{ A à } t_o 140^\circ\text{C}$	VRM = 1000 Volts	MD3	1 N 5623	001130 904 02	#20
$I_o = 3 \text{ A à } t_o 50^\circ\text{C}$	VRM = 1300 Volts	MD1	BY 255	001130 905 02*	#20
$I_o = 6 \text{ A à } t_o$	VRM = 600 Volts	MD5	P 600 J ou/or 60 S10	001130 906 02*	#16
$I_o = 1 \text{ A à } t_o 75^\circ\text{C}$	VRM = 1000 Volts	MD4	1 N 4007	001130 907 02	#20
		MD6	1 N 5646	001130 908 02*	#20
		MD6	1 N 6156	001130 909 02*	#20
		MD1	1 N 5817RL	001130 910 02	#20

Toutes autres diodes ou arrangements : merci de nous consulter.

For other diodes or layouts, please consult us.

MODULES et BARRETTES en TRAVERSEES
Consulter Amphenol Air LB

FEEDTHRU MODULES and RAILS
Please consult Amphenol Air LB

Type 1130

MODULES A RESISTANCES INSEREES MODULES WITH INSERTED RESISTANCES



Montage sur rail

Module étanche composé de 2 résistances insérées en D1 - D2. Les résistances sont reliées séparément entre deux séries de contacts à jonctions rapides, taille 20.

Les contacts sont communs par paire, ils servent d'arrivée en S1 - S3 et de départ en S2 - S4.

- Contact taille 20 (page 97). Câbles 0,21 à 0,93 mm²
Gauge 18-20-22-24 AWG.

Rail mounting

Sealed module with 2 inserted resistors in D1 - D2. Resistors are individually connected between 2 series of quick junction contacts size 20.

Contacts are in pairs and used for input in S1 - S3 and output in S2 - S4.

- Contact size 20 (page 97). Cables 0,21 to 0,93 mm²
Gage 18-20-22-24 AWG.

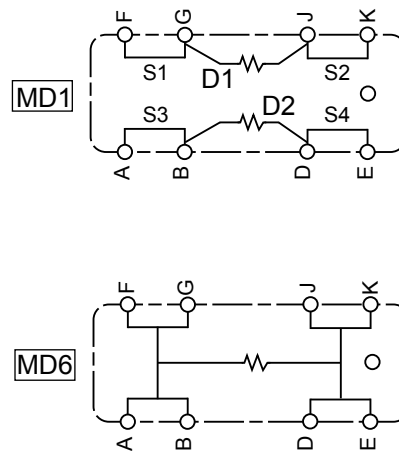
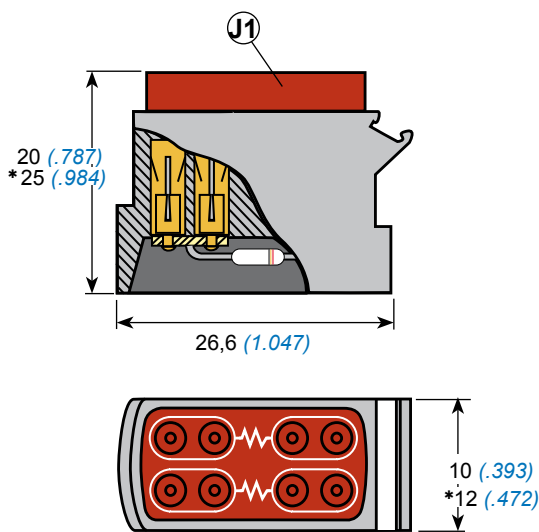

Caractéristiques RESISTANCE <i>RESISTANCE data</i>	REFERENCE <i>PART NUMBER</i>		
Courant transitoire maximal I _o <i>Maximum transitional current I_o</i>	Schéma <i>Schematic</i>	RESISTANCE <i>RESISTANCE</i>	MODULE Diode insérée <i>MODULE inserted diode</i>
120 Ohm / 0.5 W / 350 V / +/- 5%	MD6	ASNE 0593 RC31 U120 UJ	001130 802 02 *
60,4 Ohm / 0.5 W / +/- 5%	MD6	ASNE 0594 RS68 Y 60U4 D	001130 805 02 *
147 K Ohm / 0.25 W / +/- 5%	MD1	Welwyn RC55	001130 808 02
1,5 K Ohm / 0.25 W / +/- 5%	MD1	Welwyn RC55	001130 809 02

Toutes autres résistances ou arrangements : merci de nous consulter.

For other resistors or layouts, please consult us.

MODULES et BARRETTES en TRAVERSEES

Merci de nous consulter

FEEDTHRU MODULES and RAILS

Please consult us

BLOCS DE JONCTION A TIGE (BJT) STUD JUNCTION BLOCKS (BJT)



Blocs de jonction de puissance qui se juxtaposent aux modules.
Pas de 13,2 et 31,2 mm

Power junction blocks which may be placed next to modules.
Pitch of .519 and 1.228 inch

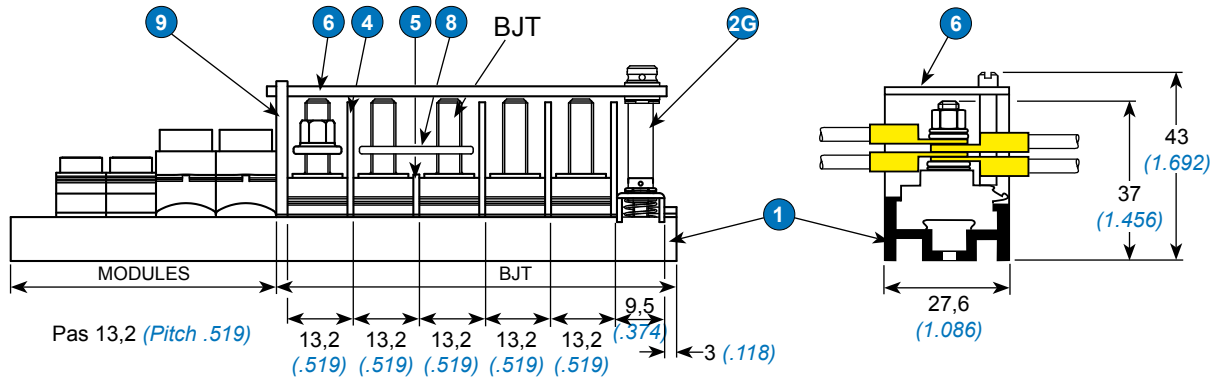

Matière isolante : EPOXY
(-55°C à + 175°C)

Insulation material : EPOXY
(-55°C to + 175°C)

Borne : acier inox
Terminal : Stainless steel

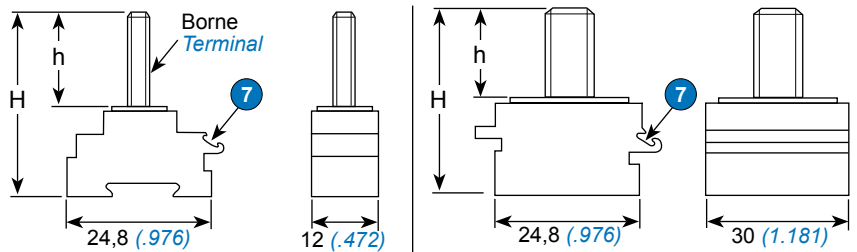

BJT	Borne Terminal		H		h		Ø 5	Ø 8
			mm	inch	mm	inch		
	M 5		28,2	1.110	12,0	.472	001152 932 37 (10,12 g.)	/
			31,2	1.228	15,0	.590	001152 935 37 (10,18 g.)	
	0.1900-32 UNF 3A		28,2	1.110	12,0	.472	001150 949 37 (10,6 g.)	
	0.1380-32 UNC 3A		28,2	1.110	12,7	.500	001150 943 37 (6,48 g.)	
	M 8		31,2	1.228	15	.590	/	
Erou Nut		M 5 + rondelle / washer					000842 050 60	/
		0.1900-32 UNF 3B					000863 190 99	
		0.1380-32 UNC 3B					000862 138 60	
		M 8 + rondelle / washer					/	
Couple de serrage mdaN Torque mdaN							0,25	1,34
CARACTERISTIQUES / DATA								
Section nominale / Nominal section							16 mm ²	70 mm ²
Tension / Voltage		V			500 V		500 V	/
Intensité A / Current A							60	125
MONTAGE / MOUNTING								
1	Rail						Page 98	
2	Butée d'arrêt End stop	gauche / left			G		001102 007 60	
		droite / right			D		001102 004 60	
4	Séparateur / Separator						001126 000 39	
5	Séparateur Sh / Sh separator						001123 000 39	
6	Capot / Cover						Page 40	
7	Repère BJT / BJT identification						Page 102	
8	Shunt			Ø 5		024055 005 04		/
				Ø 8		/		
9	Séparateur de capot / Cover separator						001121 000 37	

<p>2 BUTEE D'ARRET END STOP</p> <p>Acier inox <i>Inox steel</i></p> <p>G montée à gauche <i>left mounted</i></p> <p>D montée à droite <i>right mounted</i></p> <p>Largeur : 9 mm <i>Width : .354 inch</i></p> <p>Réf. : 001102 007 60 <i>P/N : NSA937901SD</i></p> <p>Masse / <i>Weight</i> 8,5 g</p>	<p>4 SEPARATEUR SEPARATOR</p> <p>PTFE <i>Epoxy</i></p> <p>Réf. : 001126 000 39 <i>P/N</i></p> <p>Masse / <i>Weight</i> 2,2 g</p>	<p>9 SEPARATEUR CAPOT COVER SEPARATOR</p> <p>Thermoplastique <i>Thermoplastic</i></p> <p>Réf. : 001121 000 37 <i>P/N</i></p> <p>Masse / <i>Weight</i> 5,1 g</p>
---	--	---

<p>8 SHUNT</p> <p>Laiton nickelé (5 trous) <i>Nickel plated brass (5 holes)</i></p> <p>Réf. : 024055 005 04 <i>P/N</i></p> <p>Masse / <i>Weight</i> 3,15 g</p>	<p>5 SEPARATEUR Sh Sh SEPARATOR</p> <p>PTFE <i>Epoxy</i></p> <p>Réf. : 001123 000 39 <i>P/N</i></p> <p>Masse / <i>Weight</i> 0,8 g</p>
---	--

<p>6 CAPOT COVER</p> <p>Téflon - Vis inox imperdable <i>Teflon - Captive stainless steel screw</i></p>	
<p>6¹ BARRETTE MODULES / BJT BJT / MODULE RAIL</p>	<p>6² BARRETTE BJT BJT RAIL</p>

Nbre BJT <i>BJT Nber</i>	6 ¹	Masse	6 ²	Masse
		<i>Weight</i>		<i>Weight</i>
		g		g
1	001129 101 39	4,90	001129 201 39	7,50
2	001129 102 39	6,40	001129 202 39	9,40
3	001129 103 39	8,40	001129 203 39	11,30
4	001129 104 39	10,00	001129 204 39	12,80
5	001129 105 39	11,90	001129 205 39	14,80
6	001129 106 39	13,40	001129 206 39	15,40

7, 8, 9, 10 etc...

BLOCS DE JONCTION PORTE-COMPOSANTS COMPONENT CARRIER JUNCTION BLOCKS



L : 42 mm - Pas de 7,25 et 9,25

- (A) Jonction rapide étanche munie d'un joint d'étanchéité amovible. Contact mâle (P) à sertir (page 97).
- (B) Variante BJT-M3 (écrou Nylstop + rondelle)

L : 1.653 in - Pitch of .285 and .364

- (A) Quick sealed junction provided with a removable grommet. Crimp male contact (P) (page 97).
- (B) BJT-M3 variant (Nylstop nut + washer).

FUSIBLE
FUSE
5 A
Ø 5 x 20
(.196 dia x .787)

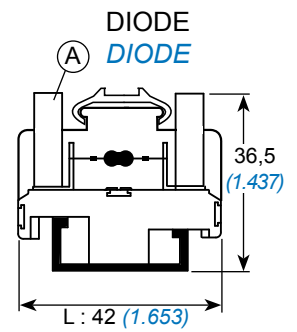
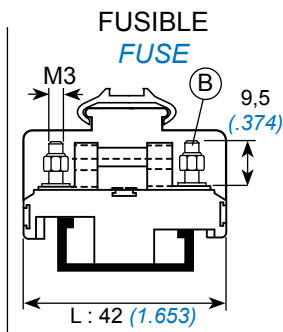
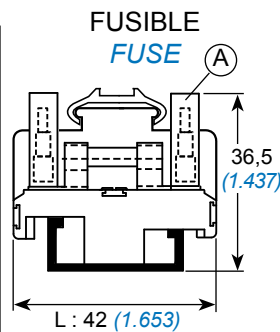
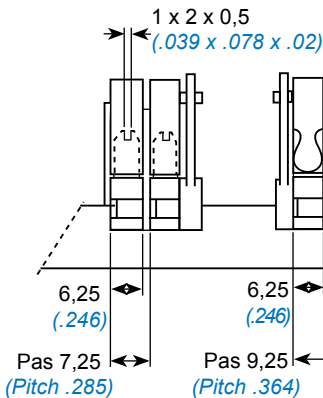
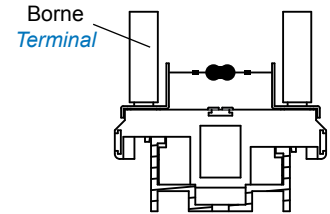
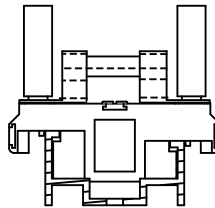

BLOC DE JONCTION / JUNCTION BLOCK		(A) Taille / Size 20	(B) M 3	(A) Taille / Size 20
BORNE / TERMINAL		001181 433 34	001181 533 34	001181 633 34
Masse / Weight		7,85 g		6,69 g
CARACTERISTIQUES / DATA				
Section nominale / Nominal section		0,6 mm ²	2,5 mm ²	0,6 mm ²
Intensité A / Current A		5	5	5
MONTAGE / MOUNTING		Pas 9,25 (Pitch .364)	Pas 9,25 (Pitch .364)	Pas 7,25 (Pitch .285)
1	Rail	001101 001 10		
2	Butée d'arrêt / End stop	001102 010 60		
4	Séparateur / Separator	001184 000 34		001182 000 34
5	Séparateur Sh Sh separator	Droit / Right	Page 43	001182 002 34
		Gauche / Left	Page 43	001182 001 34
6	Capot / Cover	022357 500 20		
	Repère capot / Cover identification	022358 100 98		
7	Repère BJ / BJ identification	122382 000 98		
8	Shunt	122375 010 02		122360 010 02
9	Séparateur de capot / Cover separator	001183 000 34		

8 SHUNT

Laiton doré - 10 trous
Gold plated brass - 10 holes

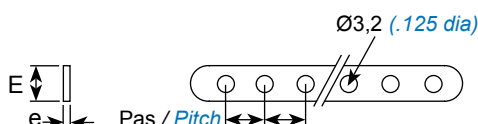

Pas Pitch		e		E		Référence Part number	Masse Weight
mm	inch	mm	inch	mm	inch		
7,25	.285	0,7	.027	6,0	.236	122360 010 02	1,98
9,25	.364	0,7	.027	7,0	.275	122375 010 02	3,08
11,0	.433	0,8	.031	7,0	.275	035127 010 02	4,35

Fractionnée de 02 à 08, consulter Amphenol Air LB
Available from 02 to 08, please consult Amphenol Air LB

L : 58,5 mm - Pas 11 mm

(A) Jonction rapide étanche munie d'un joint d'étanchéité amovible. Contact mâle (P) à sertir page 105.

L : 2.303 in - Pitch .433

(A) Quick seal junction provided with removable grommet. Crimp male contact (P) page 105.

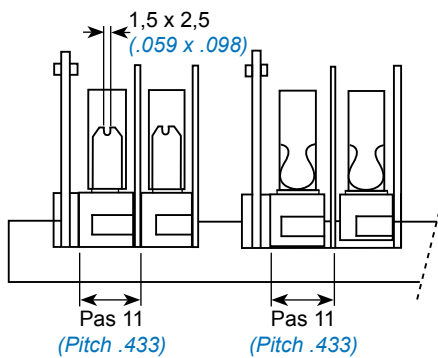

FUSIBLE / FUSE

Ø 6,35 x 31,5
(.25 dia x 1.240)

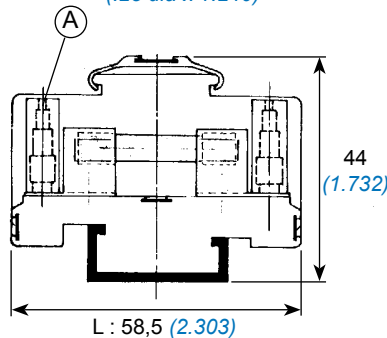

DIODE

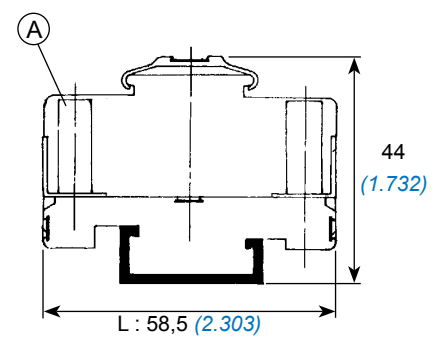

BLOC DE JONCTION / JUNCTION BLOCK		(A) Taille / Size 16	(B) Taille / Size 16
BORNE / TERMINAL		001181 635 34	001181 735 34
Masse / Weight		14,70 g	10,84 g
CARACTERISTIQUES / DATA			
Section nominale / Nominal section		0,93 mm ²	0,93 mm ²
Intensité A / Current A		15	13
MONTAGE / MOUNTING		Pas 9,25 (Pitch .364)	Pas 9,25 (Pitch .364)
1	Rail	001101 001 10	
2	Butée d'arrêt / End stop	001102 010 60	
4	Séparateur / Separator	001186 000 34	
5	Séparateur Sh Sh separator	Droit / Right	/
		Gauche / Left	001186 001 34
6	Capot / Cover	012439 500 20	
	Repère capot / Cover identification	022358 100 98	
7	Repère BJ / BJ identification	122382 000 98	
8	Shunt	/	035127 010 02
9	Séparateur de capot / Cover separator	001185 000 34	

**(R) RONDELLE FREIN
LOCKWASHER**

Acier cadmié bichromaté.
Toujours intercalée entre la borne (J) et la barrette de jonction (8)
Cadmium dichromate plated steel
Always inserted between the terminal (J) and the junction rail (8)

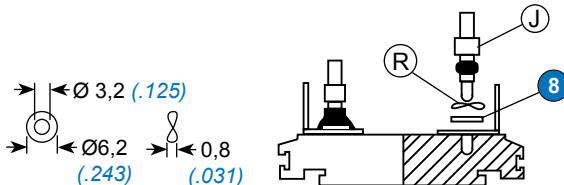

Réf. : **000570 304 07**
P/N :

**(7) REPERE DE BLOCS DE JONCTION
JUNCTION BLOCK IDENTIFICATION**

Étiquettes à fond blanc imprimées en rouge, livrées à la demande
White tags with red printing on request

(a) Vierge / Blank (b) Imprimée / Printed

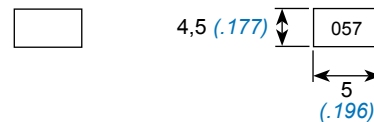

Rep. Ident.	Matière Material	Référence Part number	Masse Weight g
a	PVC	122382 000 98	0,02
b	(-40°C à +80°C)	122382 001 98	

4 SEPARATEURS SEPARATORS

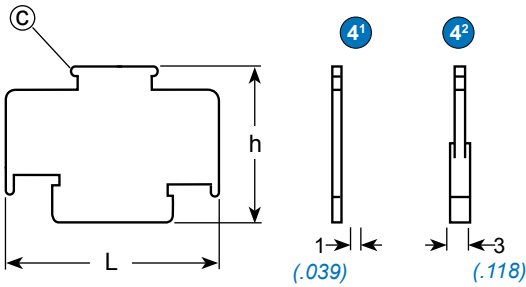

Thermoplastique noir *Black thermoplastic*

Séparateur <i>Separator</i>	Taille <i>Size</i>	L		h		Référence <i>Part number</i>	Masse <i>Weight</i> g
		mm	inch	mm	inch		
4 ¹	20	42,0	1.635	30,5	1.200	001182 000 34	1,18
	16	58,5	2.303	39,0	1.535	001186 000 34	2,08
4 ²	20	42,0	1.635	30,5	1.200	001184 000 34	2,20
	16	/					

5 SEPARATEUR Sh Sh SEPARATOR

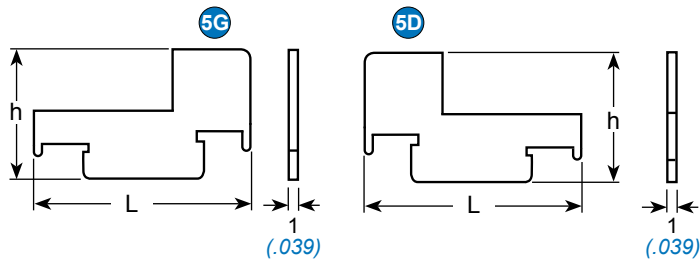

Pour shunter plusieurs bornes *To shunt many terminals*

Séparateur <i>Separator</i>	Taille <i>Size</i>	L		h		Référence <i>Part number</i>	Masse <i>Weight</i> g
		mm	inch	mm	inch		
5G <i>(gauche/left)</i>	20	42,0	1.635	26,2	1.031	001182 001 34	0,74
	16	58,5	2.303	39,0	1.535	001186 001 34	1,85
5D <i>(droite/right)</i>	20	42,0	1.635	26,2	1.031	001182 002 34	0,72
	16	/					

6 CAPOTS ENCLIQUETABLES SNAP-ON COVERS

S'encliquette sur les bossages © Nylon translucide (-40° à +80°C)

Snap-on on translucent nylon © bosses (-40°C to +80°C)

- 6¹ Blocs de jonction L 42 mm
- 6² Blocs de jonction L 58,5 mm

- 6¹ *Junction blocks L 1.653 inch*
- 6² *Junction blocks L 2.303 inch*

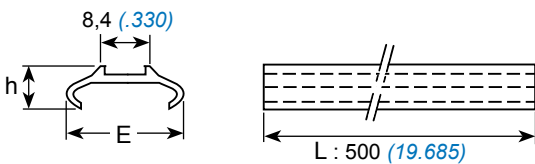

Capot <i>Cover</i>	h		E		Référence <i>Part number</i>	Masse <i>Weight</i> g
	mm	inch	mm	inch		
6 ¹	8,5	.334	21	.826	022357 500 34	20,40
6 ²	8,9	.350	30	1.181	012439 500 34	28,90

Bande repère capot / *Cover identification strip*

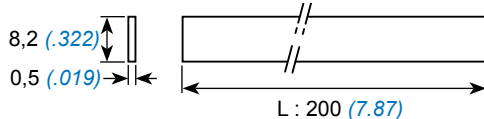

Réf. : 022358 200 98
P/N

Masse / *Weight*
1,28 g

9 SEPARATEUR CAPOT COVER SEPARATOR

Thermoplastique noir

Black thermoplastic

- 9¹ Blocs de jonction L 42 mm
- 9² Blocs de jonction L 58,5 mm

- 9¹ *Junction block L 1.653 inch*
- 9² *Junction block L 2.303 inch*

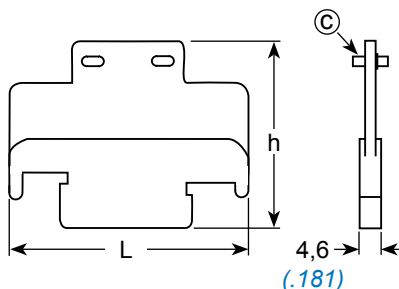

Séparateur <i>Separator</i>	Taille <i>Size</i>	L		h		Référence <i>Part number</i>	Masse <i>Weight</i> g
		mm	inch	mm	inch		
9 ¹	20	42	1.653	33	1.299	001183 000 34	3,50
9 ²	16	58,5	2.303	42	1.653	001185 000 34	4,65

REFERENTIEL

PART NUMBERING TABLE



Réf / P/N AALBF	Réf / P/N EN 3708-..	Réf / P/N OTAN	Réf / P/N NSA	Page
000570 304 07				42
000842 050 60		5310143250111		39
000842 080 60				39
000862 138 60				39
000863 190 99		5310144438139		39
001100 264 02				35
001100 267 02				35
001100 271 02				35
001100 272 02				35
001101 001 10	005A1000	9520143730917		41-42
001102 004 60		5940143460630	NSA937901SC	39-40
001102 007 60		5940143460631	NSA937901SD	39-40
001102 010 60				41-42
001107 200 60		5940143130033		36
001107 200 61		5940143008317	NSA93791520	36
001107 300 60		5940140417062		36
001107 300 61		5940143883538	NSA93791516	36
001115 101 02	003A01	5999144362736	NSA937901M2201	33
001115 101 02 Y				36
001115 102 02	003A02	5999144213957	NSA937901M2202	33
001115 103 02	003A03		NSA937901M2203	33
001115 104 02	003A04		NSA937901M2204	33
001115 104 02Y				36
001115 105 02	003A05		NSA937901M2205	33
001115 105 02Y				36
001115 106 02	003A06		NSA937901M2206	33
001115 150 02				35
001115 151 02				35
001115 201 02	003B01	5940143460632	NSA937901M2001	33
001115 201 02Y				36
001115 201 02Z				36
001115 202 02	003B02	5999143491790	NSA937901M2002	33
001115 202 02Y				36
001115 203 02	003B03	59401438599886	NSA937901M2003	33
001115 204 02	003B04	59991434600633	NSA937901M2004	33
001115 205 02	003B05	5999143741382	NSA937901M2005	33
001115 205 02Y				36
001115 206 02	003B06	5999143460634	NSA937901M2006	33
001115 207 02	003B07	5940143513933	NSA937901M2007	33
001115 208 02	003B08	5999143460635	NSA937901M2008	33-34
001115 209 02	003B09	5999143460636	NSA937901M2009	33
001115 209 02Y				36
001115 209 02Z				36
001115 210 02	003B10	5999143992019	NSA937901M2010	33
001115 211 02	003B11	5999143460637	NSA937901M2011	33
001115 211 02Y				36
001115 211 02Z				36
001115 301 01	003C01		NSA937901M1601	34
001115 301 02	003C02	5940143497421	NSA937901M1602	34
001115 303 02	003C03		NSA937901M1603	34
001115 304 02	003C04	5999143591486	NSA937901M1604	34
001115 305 02	003C05	5940143513932	NSA937901M1605	34
001115 306 02	003C06	5940143602055	NSA937901M1606	34
001115 308 02	003C08	5999144201076		34
001115 401 02	003D01		NSA937901M1203	34
001115 402 02	003D02	5999144362734	NSA937901M1204	34
001115 403 02	003D03		NSA937901M1205	34
001115 404 02	003D04	5999144362733	NSA937901M1206	34
001115 501 02	003C51	5940143589071	NSA937901M1202	33
001115 503 02			NSA937901M1207	33
001118 202 02			NSA937916-20	34
001118 202 02Y				36
001118 302 02			NSA937916-16	34
001118 302 02Y				36
001118 501 02				34

REFERENTIEL

PART NUMBERING TABLE



Réf / P/N AALBF	Réf / P/N EN 3708-..	Réf / P/N OTAN	Réf / P/N NSA	Page
001121 000 37		5970143637668	NSA937901P	39-40
001123 000 39		5970143755943	NSA937901IN	39-40
001126 000 39		5970143491815	NSA937901IS	39-40
001129 101 39				40
001129 102 39				40
001129 103 39				40
001129 104 39				40
001129 105 39				40
001129 106 39				40
001129 201 39				40
001129 202 39				40
001129 203 39				40
001129 204 39				40
001129 205 39				40
001129 206 39				40
001130 802 02				38
001130 805 02				38
001130 808 02				38
001130 809 02				38
001130 901 02				37
001130 902 02				37
001130 903 02				37
001130 904 02				37
001130 905 02				37
001130 906 02				37
001130 907 02				37
001130 908 02				37
001130 909 02				37
001130 910 02				37
001145 201 02Y				36
001145 201 02Z				36
001145 212 02Y				36
001145 212 02Z				36
001150 943 37				39
001150 949 37		5940143460648	NSA937901B	39
001152 932 37				39
001152 935 37		5940143755944		39
001152 938 37				39
001152 943 37				39
001152 949 37				39
001181 433 34		5940143256499		41
001181 533 34		5940143589073		41
001181 633 34				41
001181 635 34		5940143637220		42
001181 735 34				42
001182 000 34				41-43
001182 001 34				41-43
001182 002 34				41-43
001183 000 34		5940143637219		41-43
001184 000 34		5940143256510		41-43
001185 000 34		5940143589075		42-43
001186 000 34		5970143589075		42-43
001186 001 34				42-43
012439 500 20		5940143730924		42
012439 500 34				43
022357 500 20		5940142363420		41
022357 500 34				43
022358 100 98				41-42
022358 200 98		9905143540960		43
024055 005 04		6150143755945	NSA937901SH05	39-40
035127 010 02				42
122360 010 02		5940142147138		41
122375 010 02				41
122382 000 98		9905142631896		41-42
122382 001 98		9905143256604		42

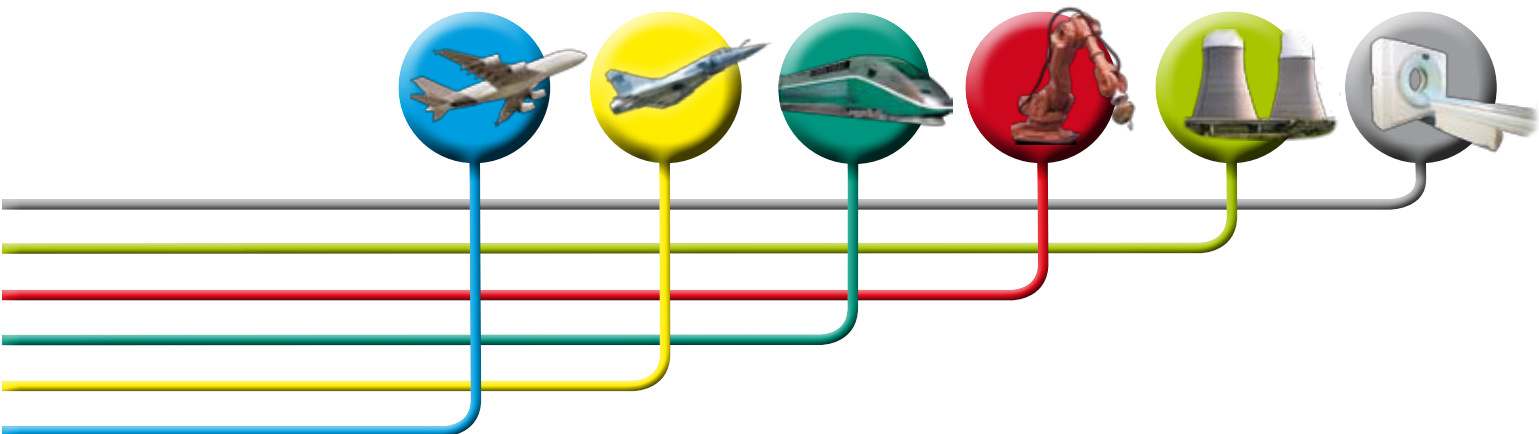

**Modules 1200
- Micro intensité -
ABS 1569**

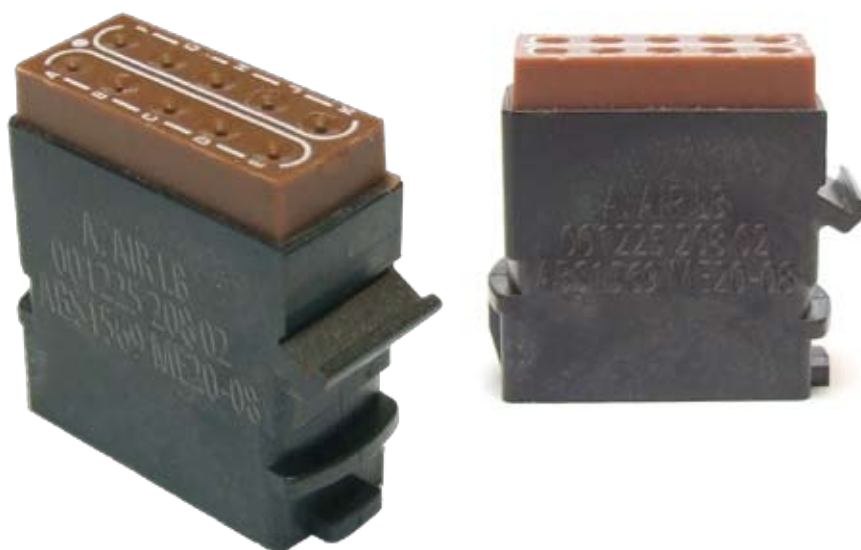

***1200 Modules
- Micro intensity -
ABS 1569***

Edition 05/12

Amphenol Air LB

SYSTEMES DE CONNEXIONS ELECTRIQUES ET ELECTRONIQUES
ELECTRIC AND ELECTRONIC CONNECTION SYSTEMS

PRESENTATION PRESENTATION



Type 1200 : Avec repérage alphabétique imprimé sur la face de jonction des modules.



Type 1200 : With alphabetical identification printed on module junction face.

Pour contacts femelles

Les modules de distribution amovibles **type 1200** sont montés en barrettes par encliquetage à l'intérieur d'un rail métallique ou composite dissymétrique. Ces modules sont destinés à l'utilisation de micro-intensité.

Ils conviennent à des contacts femelles à sertir (S) normalisés taille 20 pour des gauges 24 à 18 AWG qui correspondent à des sections de câbles de 0,25 à 1 mm².

- Modules conformes à la norme **ABS1569**
- Contacts femelles à sertir (S), conformes aux normes **EN 3155-015F2018** à montage et démontage rapides avec des outils normalisés
- Deux types de rails métalliques coupés à la demande
- 11 arrangements disponibles
- Montage des modules individuellement
- Juxtaposition possible avec les modules de type 1100

For Socket contacts

Removable distribution modules **type 1200** are mounted on rails by sliding them inside a metal dissymmetrical rail. This modules are recommended in case of micro-intensity use.

Modules are suitable for standard socket crimp contacts (S) size 20, gage 24 to 18 AWG corresponding to cable sections from 0.25 to 1 mm².

- Modules comply with **ABS1569** standard
- Crimp socket contacts (S) comply with **EN 3155-015F2018** standards. May be inserted or extracted with standard tools
- Two types of metal rails, cut to measure
- Large range of contact layouts
- Modules mounted individually
- Modules can be mounted with 1100 series

CARACTERISTIQUES TECHNIQUES TECHNICAL DATA

MECANIQUE

Module	Matière	: Thermoplastique
Joint	Matière	: Elastomère de silicone
Contact	Matière	: Alliage cuivreux
	Protection	: Or sur nickel
Endurance	Modules non étanches	: 50 cycles de montage/démontage du contact dans cavité
	Modules étanches	: 10 cycles de montage/démontage du contact dans cavité
Vibrations		: Sinusoïdales fréquence de 5 à 3000 Hz accélération 20 g. 4h/axe, discontinuité ≤ 1 µs
Chocs		: 100 g 1/2 sinus, 6 ms (3 chocs dans 3 directions)
Rétention contacts		: taille 20 : 6,7 daN

RESISTANCE AUX FLUIDES

Tenue : Conforme normes ABD 0100.1.2

CLIMATIQUE

Température d'utilisation	: -55°C à +175°C
Endurance	: 1000h à 175°C
Chaleur humide	: 21j à 40°C et 93% HR
Résistance au Brouillard Salin	: 48h

ELECTRIQUE

Tension de tenue :	
au niveau de la mer	: 1 500 V eff. 50 Hz
21 000 mètres	: 350 V rms
Résistance d'isolement	: ≥ à 5 000 MΩ
Résistance de contacts	: taille 20 : 4 mΩ
Intensité maxi du contact	: taille 20 : 7,5 A

MECHANICAL

Module	Material	: Thermoplastic
Grommet	Material	: Silicon elastomer
Contact	Material	: Copper alloy
Plating		: Gold on nickel
Endurance	Not sealed modules	: 50 complete mounting/unmounting cycles of contcats into the cavity
	Sealed modules	: 10 complete mounting/unmounting cycles of contcats into the cavity
Vibrations		: Sinusoidal frequency from 5 to 3000 Hz acceleration 20 g. 4h/axe, discontinuity ≤ 1 µs
Shocks		: 100 g 1/2 sinus, 6 ms (3 shocks in 3 directions)
Contact retention		: size 20 : 6,7 daN

RESISTANCE TO FLUIDS

Resistance : Complies with standards ABD 0100.1.2

ENVIRONMENT

Operating temperature	: -55° to +175°C
Endurance	: 1000h à 175°C
Damp heat	: 21j à 40°C et 93% HR
Salt spray resistance	: 48h

ELECTRICAL

Withstanding voltage :	
at sea level	: 1 500 V eff. 50 Hz
21 000 meters	: 350 rms
Insulation resistance	: ≥ at 5 000 MΩ
Contact resistance	: size 20 : 4 mΩ
Max. contact current rating	: size 20 : 7,5 A

SYSTEME DE REFERENCE PART NUMBERING SYSTEM



TYPE DE MODULE 1200 / TYPE OF 1200 MODULE

Non étanches / *Unsealed*
Etanches / *Sealed*

ARRANGEMENTS DES SHUNTS / SHUNTS LAYOUTS

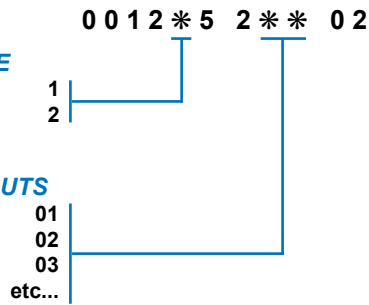

MODULES 1200 1200 MODULES

Taille 20
Size 20

10 Contacts
(7,5 A)

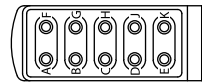
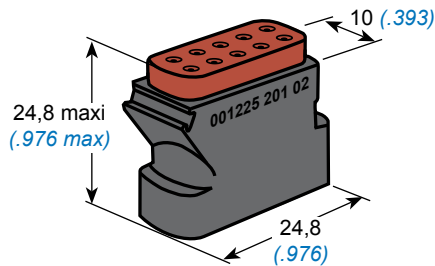

0012*5 201 02

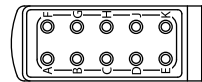

0012*5 202 02

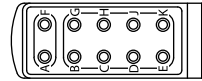

0012*5 203 02

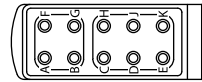

0012*5 204 02

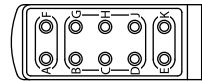

0012*5 205 02

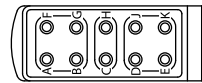

0012*5 206 02

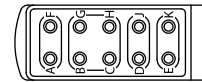

0012*5 207 02

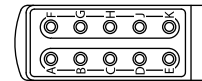

0012*5 208 02

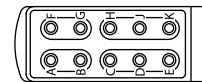

0012*5 209 02

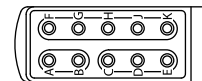

0012*5 210 02

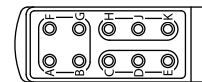

0012*5 211 02

Les contacts femelles (S) sont du type à sertir, en alliage de cuivre nickelé doré, normalisés EN 3155-015F2018

The crimp socket contacts (S), are made of copper-nickel alloy and are in compliance with EN 3155-015F2018 standard

DIMENSIONS BARETTES 1100 & 1200

1100 & 1200 RAIL DIMENSIONS

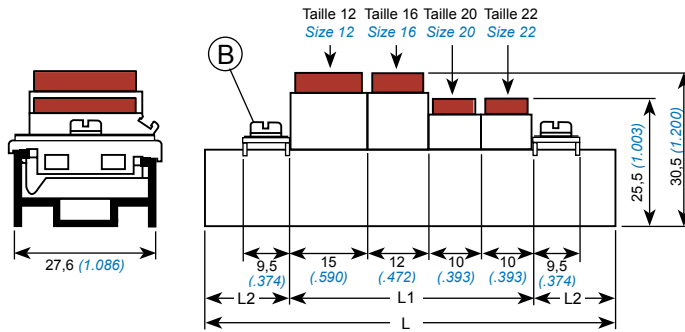

$L = L1 + (2 \times L2)$ arrondir à un multiple de 10
 L1 : Longueur des modules
 L2 : Butée d'arrêt (B) + 5 mm minimum

$L = L1 + (2 \times L2)$ rounded to a multiple of 10
 L1 : Length of the modules
 L2 : End stop (B) + .196 in minimum

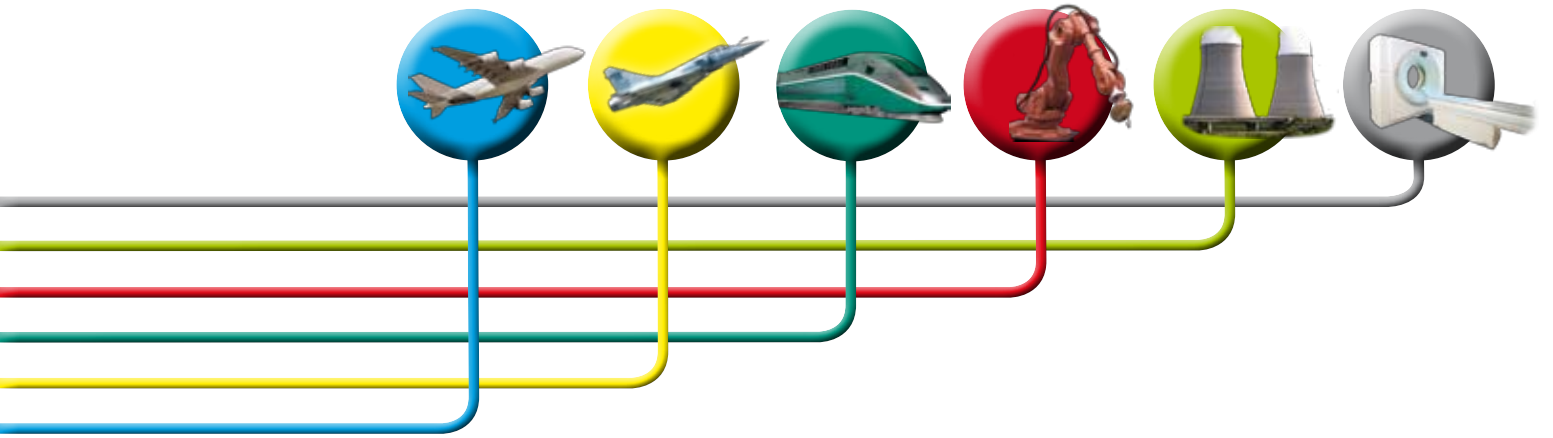

Modules aux Normes MIL



MIL Spec. Modules

Edition 05/12

Amphenol Air LB

SYSTEMES DE CONNEXIONS ELECTRIQUES ET ELECTRONIQUES
ELECTRIC AND ELECTRONIC CONNECTION SYSTEMS

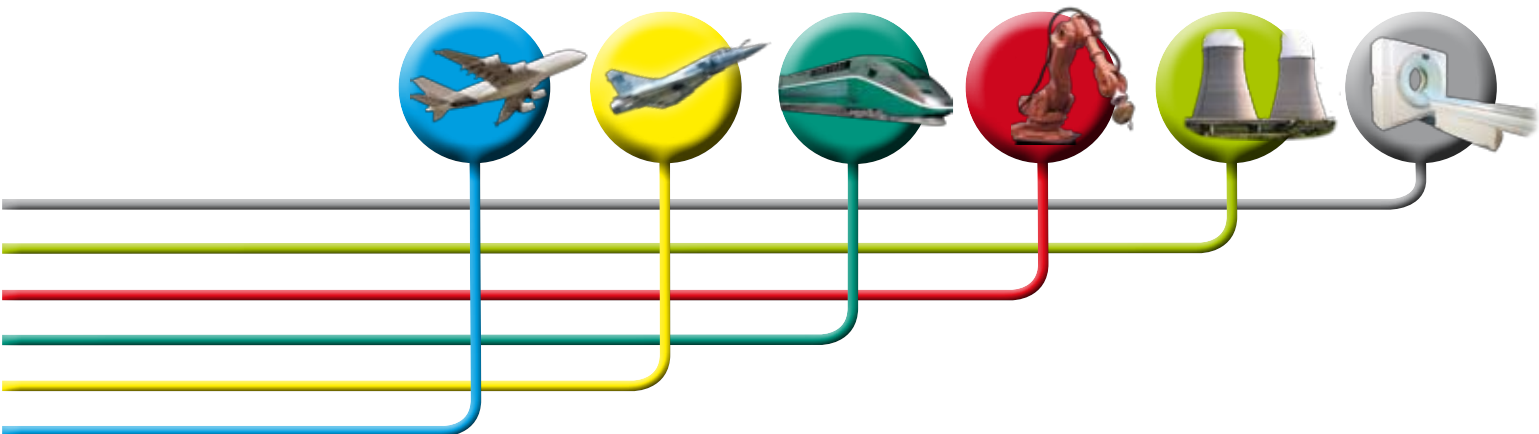

Modules MIL-T-81714 Série I



Serie I MIL-T-81714 Modules

Edition 05/12

Amphenol Air LB

SYSTEMES DE CONNEXIONS ELECTRIQUES ET ELECTRONIQUES
ELECTRIC AND ELECTRONIC CONNECTION SYSTEMS

PRESENTATION PRESENTATION



MODULES DE JONCTIONS SERIE I MIL-T-81714

Les modules certifiés QPL MIL-T-81714 sont disponibles en quatre tailles standards de la gauge 12 à la gauge 26 AWG, et déclinés en versions à retour ou de traversée dans une sélection complète d'arrangements.

L'assemblage breveté des conducteurs femelles internes au module présente des caractéristiques électriques élevées, et assure une intégrité mécanique sur toute la durée de vie du produit. Cette conception unique supprime l'utilisation de soudures de joints, technique qui pouvait causer des variations électriques et altérer les performances mécaniques.

Les contacts femelles présents dans le module n'ont pas de fonction mécanique, et bénéficient d'un alliage hautement conducteur.

SYSTEME DE MODULES CLASSE D

Amphenol fut le premier fournisseur à qualifier son système de modules et rails selon les exigences de classe D de la norme MIL-T-81714.

L'appartenance à cette classification confère aux modules la reconnaissance d'une haute tenue en température et aux fluides, précédemment divisée en trois catégories : A, B et C.

Tous nos modules se montent sur rail (voir page 99) et sont livrés avec le nombre de contacts correspondant à l'arrangement choisi, plus un, et avec un obturateur.

MIL-T-81714 SERIES I JUNCTION MODULES

QPL-approved MIL-T-81714 modules and MIL-C-39029/1 contacts are available in four standard sizes accommodating 12-26 AWG wires in both feedback and feedthru types with a full selection of bussing arrangements.

The patented integral socket/bus bar assembly provides superior electrical characteristics and ensures mechanical integrity over a long product life. This unique design totally eliminates all solder of welded joints which could cause variation in electrical and/or mechanical performance.

Integral female contacts and bus bar have no mechanical functions - only the electrical conductivity function and are highly conductive alloy for optimum electrical performance.

D CLASS MODULES SYSTEM

Amphenol was the first supplier to qualify module and track systems to high performance MIL-T-81714 Series I Class D requirements. Class D systems combine the maximum high temperature and high fluid resistance performance parameters previously divided into three module classes : A, B, and C.

Every module can be mounted on rail (see on page 99) and is supplied with contacts according to the chosen layout, with one more contact and one sealing plug in addition.

CARACTERISTIQUES TECHNIQUES TECHNICAL DATA

MECANIQUE

Boîtier Matière : Thermoplastique suivant ASTM-D5205
Joint Matière : Elastomère silicone suivant A-A-59588
Contact Matière : Alliage cuivreux
Protection : Or sur nickel selon MIL-G-45204
Chocs & Vibrations : MIL-T-81714 §3.5.5 & 3.5.8
Endurance : 500 cycles complets de verrouillage et déverrouillage

RESISTANCE AUX FLUIDES

Tenue : suivant MIL-STD-1344 méthode 1016

CLIMATIQUE

Température d'utilisation : -65° à +200° C

ELECTRIQUE

Résistance d'isolement : 5000 MΩ à 25°C
Tension de tenue : 1500 VRMS au niveau de la mer
200 VRMS à 30480 mètres
Tension de tenue module haute densité :
1000 VRMS au niveau de la mer
200 VRMS à 30480 mètres
Résistance de contacts :
taille 22D : 15 mΩ
taille 22 : 15 mΩ
taille 20 : 9 mΩ
taille 16 : 5 mΩ

MECHANICAL

Shell Material : Thermoplastic as per ASTM-D5205
Seal Material : Silicon Blend Elastomer per A-A-59588
Contact Material : Copper alloy
Plating : Gold on nickel per MIL-G-45204
Shocks & Vibrations : MIL-T-81714 §3.5.5 & 3.5.8
Endurance : 500 full mating/unmating cycles

RESISTANCE TO FLUIDS

High fluid resistance : as per MIL-STD 1344 method 1016

ENVIRONMENT

Operating temperature : -65° to +200° C

ELECTRICAL

Insulation resistance : 5000 MΩ at 25°C
Dielectric withstanding voltage : 1500 VRMS at sea level
200 VRMS at 100000 ft
High density modules dielectric withstanding voltage :
1500 VRMS at sea level
200 VRMS at 100000 ft
Contact resistance :
size 22D : 15 mΩ
size 22 : 15 mΩ
size 20 : 9 mΩ
size 16 : 5 mΩ

MODULES M81714/1 SERIE I - CLASS D

M81714/1 SERIE I - CLASS D



MODULE A RETOUR

FEEDBACK MODULE

Taille 16/22*
Size 16/22*

10 Contacts
(5 A)

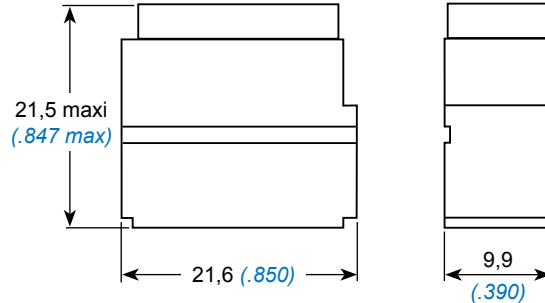

Module à retour / Feedback module		
Arrangement Layout	Référence MIL MIL Part number	Référence Amphenol Amphenol P/N
	M81714/1-DA1	TJM122701
	M81714/1-DB1	TJM122702
	M81714/1-DB2	TJM122703
	M81714/1-DB3	TJM122704
	M81714/1-DC1	TJM122705
	M81714/1-DC2	TJM122706
	M81714/1-DC3	TJM122710
	M81714/1-DC4	TJM122712
	M81714/1-DD1	TJM122707
	M81714/1-DD2	TJM122711
	M81714/1-DE1	TJM122708

Les contacts mâles (P) sont du type à sertir, en alliage de cuivre nickelé doré, normalisés M39029/1-100

The crimp pin contacts (P), are made of copper-nickel alloy and are in compliance with M39029/1-100 standard.

* taille interface / fût de sertissage

* mating end size / wire barrel size

MODULES M81714/2, /7 SERIE I - CLASS D

M81714/2, /7 SERIE I - CLASS D



Taille 16/20*
Size 16/20*

10 Contacts
(7,5 A)

MODULE A RETOUR / FEEDBACK MODULE

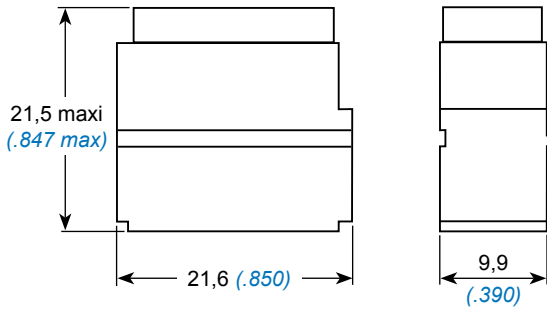

MODULE DE TRAVERSEE / FEEDTHROUGH MODULE

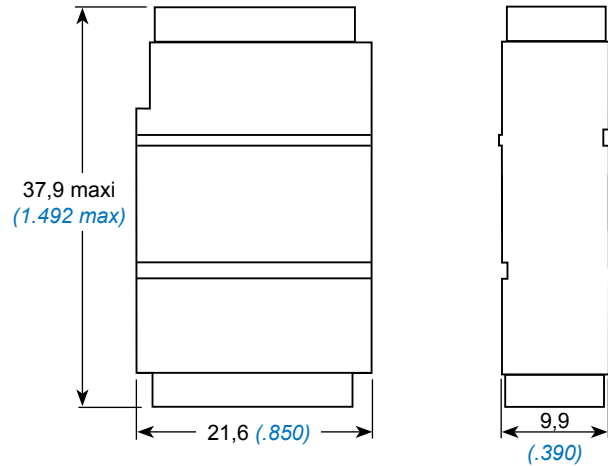

Arrangement Layout	Module à retour / Feedback module		Module de traversée / Feedthru module	
	Référence MIL MIL Part number	Référence Amphenol Amphenol P/N	Référence MIL MIL Part number	Référence Amphenol Amphenol P/N
	M81714/2-DA1	TJM120701	M81714/7-DA1	TJM220701
	M81714/2-DB1	TJM120702	M81714/7-DB1	TJM220702
	M81714/2-DB2	TJM120703	M81714/7-DB2	TJM220703
	M81714/2-DB3	TJM120704	M81714/7-DB3	TJM220704
	M81714/2-DC1	TJM120705	M81714/7-DC1	TJM220705
	M81714/2-DC2	TJM120706	M81714/7-DC2	TJM220706
	M81714/2-DC3	TJM120710		
	M81714/2-DC4	TJM120712		
	M81714/2-DD1	TJM120707	M81714/7-DD1	TJM220707
	M81714/2-DD2	TJM120711		
	M81714/2-DE1	TJM120708	M81714/7-DE1	TJM220708
			M81714/7-DJ1	TJM220709

Les contacts mâles (P) sont du type à sertir, en alliage de cuivre nickelé doré, normalisés M39029/1-101

The crimp pin contacts (P), are made of copper-nickel alloy and are in compliance with M39029/1-101 standard.

* taille interface / fût de sertissage

* mating end size / wire barrel size

MODULES M81714/3 SERIE I - CLASS D

M81714/3 SERIE I - CLASS D



Taille 14/16*
Size 14/16*

8 Contacts
(13A)

MODULE A RETOUR

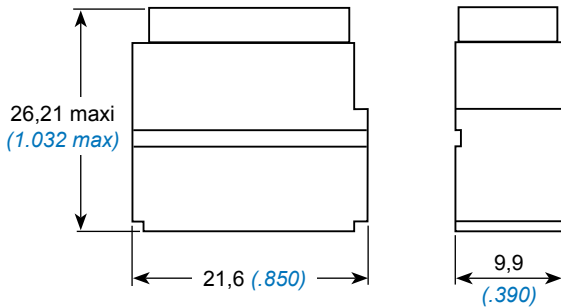

FEEDBACK MODULE

Module à retour / Feedback module		
Arrangement Layout	Référence MIL MIL Part number	Référence Amphenol Amphenol P/N
	M81714/3-DA1	TJM116701
	M81714/3-DB1	TJM116702
	M81714/3-DB2	TJM116703
	M81714/3-DC1	TJM116705
	M81714/3-DC2	TJM116706
	M81714/3-DD1	TJM116707

Les contacts mâles (P) sont du type à sertir, en alliage de cuivre nickelé doré, normalisés M39029/1-102

The crimp pin contacts (P), are made of copper-nickel alloy and are in compliance with M39029/1-102 standard.

MODULES M81714/4 SERIE I - CLASS D

M81714/4 SERIE I - CLASS D

Taille 12/12*
Size 12/12*

8 Contacts
(23 A)

MODULE A RETOUR

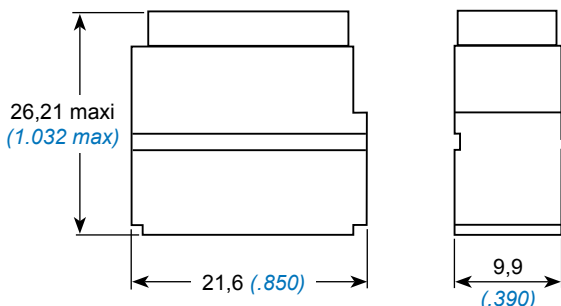

FEEDBACK MODULE

Module à retour / Feedback module		
Arrangement Layout	Référence MIL MIL Part number	Référence Amphenol Amphenol P/N
	M81714/4-DA1	TJM112701
	M81714/4-DB1	TJM112702
	M81714/4-DB2	TJM112703
	M81714/4-DC1	TJM112705
	M81714/4-DC2	TJM112706
	M81714/4-DD1	TJM112707

Les contacts mâles (P) sont du type à sertir, en alliage de cuivre nickelé doré, normalisés M39029/1-103

The crimp pin contacts (P), are made of copper-nickel alloy and are in compliance with M39029/1-103 standard.

* taille interface / fût de sertissage

* mating end size / wire barrel size

MODULES M81714/17 SERIE I - HAUTE DENSITE

M81714/17 SERIE I - HIGH DENSITY



Taille 20/22D*
Size 20/22D*

21 Contacts
(5 A)

MODULE A RETOUR

FEEDBACK MODULE

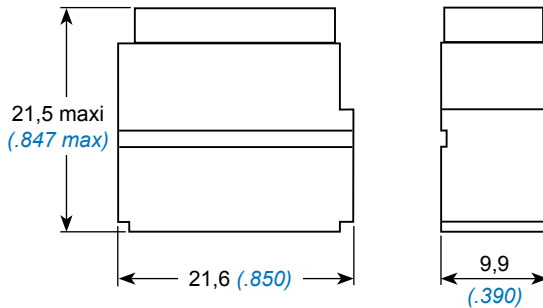

Arrangement <i>Bussing configuration</i>	Module à retour / <i>Feedback module</i>		Arrangement <i>Layouts</i>	Module à retour / <i>Feedback module</i>	
	Référence MIL <i>MIL Part number</i>	Référence Amphenol <i>Amphenol P/N</i>		Référence MIL <i>MIL Part number</i>	Référence Amphenol <i>Amphenol P/N</i>
	M81714/17-D30	TJHD22700		M81714/17-D38	TJHD22708
	M81714/17-D31	TJHD22701		M81714/17-D39	TJHD22709
	M81714/17-D32	TJHD22702		M81714/17-D40	TJHD22710
	M81714/17-D33	TJHD22703		M81714/17-D42	TJHD22712
	M81714/17-D34	TJHD22704		M81714/17-D43	TJHD22713
	M81714/17-D35	TJHD22705		M81714/17-D44	TJHD22714
	M81714/17-D36	TJHD22706		M81714/17-D45	TJHD22715
	M81714/17-D37	TJHD22707			

Les contacts mâles (P) sont du type à sertir, en alliage de cuivre nickelé doré, normalisés M39029/1-507

The crimp pin contacts (P), are made of copper-nickel alloy and are in compliance with M39029/1-507 standard.

* taille interface / fût de sertissage

* mating end size / wire barrel size

REFERENTIEL

PART NUMBERING TABLE



Réf / P/N AALBF	Norme / Standard M81714/..	Page
TJHD22700	17-D30	57
TJHD22701	17-D31	57
TJHD22702	17-D32	57
TJHD22703	17-D33	57
TJHD22704	17-D34	57
TJHD22705	17-D35	57
TJHD22706	17-D36	57
TJHD22707	17-D37	57
TJM112701	4-DA1	56
TJM112702	4-DB1	56
TJM112703	4-DB2	56
TJM112705	4-DC1	56
TJM112706	4-DC2	56
TJM112707	4-DD1	56
TJM116701	3-DA1	56
TJM116702	3-DB1	56
TJM116703	3-DB2	56
TJM116705	3-DC1	56
TJM116706	3-DC2	56
TJM116707	3-DD1	56
TJM120701	2-DA1	55
TJM120702	2-DB1	55
TJM120703	2-DB2	55
TJM120704	2-DB3	55
TJM120705	2-DC1	55
TJM120706	2-DC2	55
TJM120707	2-DD1	55
TJM120708	2-DE1	55
TJM120710	2-DC3	55
TJM120711	2-DD2	55
TJM120712	2-DC4	55
TJM122701	1-DA1	54
TJM122702	1-DB1	54
TJM122703	1-DB2	54
TJM122704	1-DB3	54
TJM122705	1-DC1	54
TJM122706	1-DC2	54
TJM122707	1-DD1	54
TJM122708	1-DE1	54
TJM122710	1-DC3	54
TJM122711	1-DD2	54
TJM122712	1-DC4	54
TJM220701	7-DA1	55
TJM220702	7-DB1	55
TJM220703	7-DB2	55
TJM220704	7-DB3	55
TJM220705	7-DC1	55
TJM220706	7-DC2	55
TJM220707	7-DD1	55
TJM220708	7-DE1	55
TJM220709	7-DJ1	55

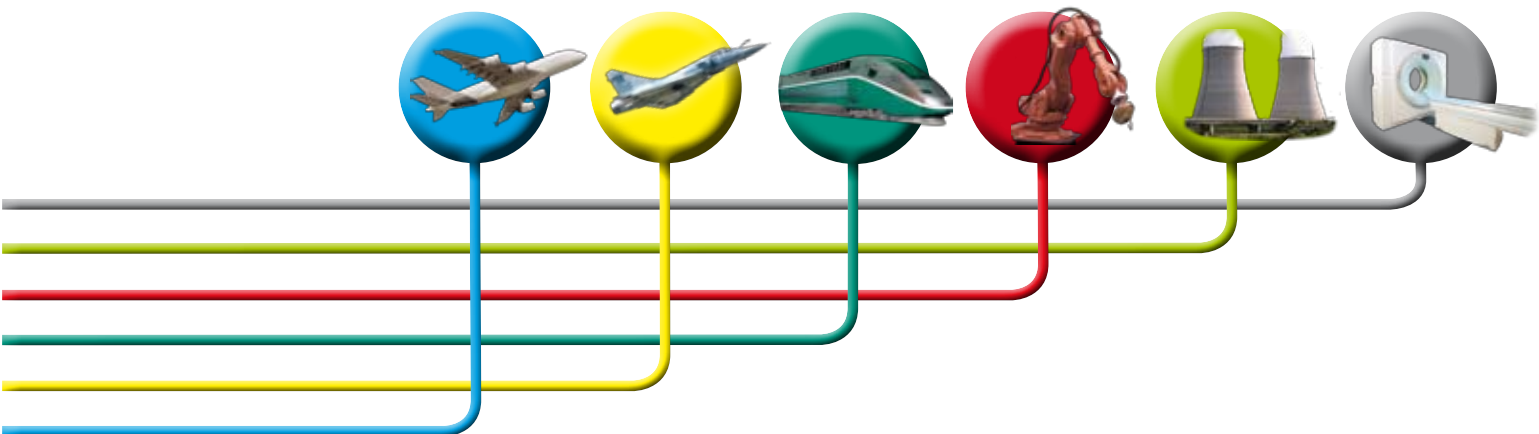

Modules MIL-T-81714 Série II

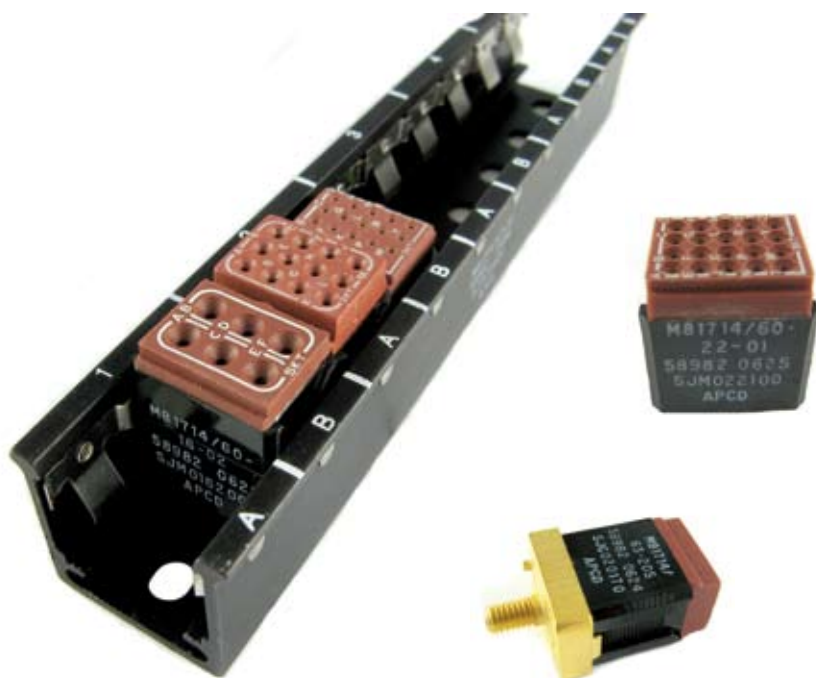

Serie II MIL-T-81714 Modules

Edition 05/12

Amphenol Air LB

SYSTEMES DE CONNEXIONS ELECTRIQUES ET ELECTRONIQUES
ELECTRIC AND ELECTRONIC CONNECTION SYSTEMS

PRESENTATION PRESENTATION



MODULES DE JONCTIONS SERIE II MIL-T-81714

Le système de modules de jonctions MIL-T-81714 Serie II est décliné pour quatre tailles de contacts femelles, de la gauge 12 à la gauge 26 AWG, dans une large variété d'arrangements. Les modules sont livrés avec les contacts femelles correspondants, normalisés MIL-C-39029/22

PERFORMANCES ACCRUES

La conception innovante des modules de la Serie II assure des performances supérieures à la moyenne en termes d'étanchéité, d'alignement et de rétention des contacts, ainsi que dans l'extraction des modules.

Tous nos modules se montent sur rail (voir page 99) et sont livrés avec le nombre de contacts correspondants à l'arrangement choisi, plus un, et avec un obturateur.

MIL-T-81714 SERIES II JUNCTION MODULES

The high pin count, low weight MIL-T-81714 Series II Socket Junction Module System is available in four basic module sizes, accomodating 12-26 AWG wire in a broad selection of bussing arrangements.

Modules are supplied with the appropriate and specified MIL-C-39029/22 socket contacts

IMPROVED PERFORMANCE

Significant Amphenol design innovations over conventional Series II systems ensure superior performance in wire sealing, contact alignment and retention, and module extraction.

Every module can be mounted on rail (see on page 99) and is supplied with contacts according to the choosen layout, with one more contact and one sealing plug in addition.

CARACTERISTIQUES TECHNIQUES TECHNICAL DATA

MECANIQUE

Boîtier Matière : Thermoplastique suivant ASTM-D5205
Joint Matière : Elastomère silicone suivant A-A-59588
Contact Matière : Alliage cuivreux
Protection : Or sur nickel selon MIL-G-45204
Chocs & Vibrations : MIL-T-81714 §3.5.5 & 3.5.8
Endurance : 500 cycles complets de verrouillage et déverrouillage

RESISTANCE AUX FLUIDES

Tenue : suivant MIL-STD-1344 méthode 1016

CLIMATIQUE

Température d'utilisation : -65° à +200° C

ELECTRIQUE (sauf modules de masse)

Résistance d'isolement : 5000 MΩ à 25°C
Tension de tenue : 1500 VRMS au niveau de la mer
200 VRMS à 30480 mètres
Résistance de contacts
taille 22D : 15 mΩ
taille 22 : 15 mΩ
taille 20 : 9 mΩ
taille 16 : 5 mΩ

MECHANICAL

Shell Material : Thermoplastic as per ASTM-D5205
Seal Material : Silicon Blend Elastomer per A-A-59588
Contact Material : Copper alloy
Plating : Gold on nickel per MIL-G-45204
Shocks & Vibrations : MIL-T-81714 §3.5.5 & 3.5.8
Endurance : 500 full mating/unmating cycles

RESISTANCE TO FLUIDS

High fluid resistance : as per MIL-STD 1344 method 1016

ENVIRONMENT

Operating temperature : -65° to +200° C

ELECTRICAL (all but ground modules)

Insulation resistance : 5000 MΩ at 25°C
Dielectric withstanding voltage : 1500 VRMS at sea level
200 VRMS at 100000 ft
Contact resistance
size 22D : 15 mΩ
size 22 : 15 mΩ
size 20 : 9 mΩ
size 16 : 5 mΩ

MODULES M81714/60-22 SERIE II

M81714/60-22 SERIE II



Taille 22/22* 20 Contacts
Size 22/22* (5 A)

MODULE A RETOUR

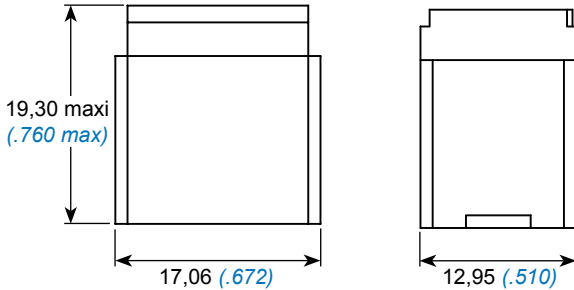

* taille interface / fût de sertissage
* mating end size / wire barrel size

Les contacts femelles (S) sont du type à sertir, en alliage de cuivre nickelé doré, normalisés M39029/22-191 (p.106)

FEEDBACK MODULE

Arrangement Layout	Référence MIL MIL Part number	Référence Amphenol Amphenol P/N
	M81714/60-22-01	SJM022100
	M81714/60-22-02	SJM022200
	M81714/60-22-04	SJM022400
	M81714/60-22-05	SJM022500
	M81714/60-22-06	SJM022600
	M81714/60-22-10	SJM022700

The crimp sockets contacts (S), are made of copper-nickel alloy and are in compliance with M39029/22-191 standard (p.106)

MODULES M81714/60-20 SERIE II

M81714/60-20 SERIE II

Taille 20/20* 12 Contacts
Size 20/20* (7,5 A)

MODULE A RETOUR

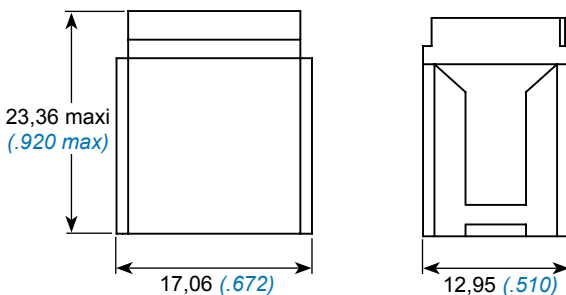

* taille interface / fût de sertissage
* mating end size / wire barrel size

Les contacts femelles (S) sont du type à sertir, en alliage de cuivre nickelé doré, normalisés M39029/22-192 (p.106)

FEEDBACK MODULE

Arrangement Layout	Référence MIL MIL Part number	Référence Amphenol Amphenol P/N
	M81714/60-20-01	SJM020100
	M81714/60-20-02	SJM020200
	M81714/60-20-03	SJM020300
	M81714/60-20-04	SJM020400
	M81714/60-20-06	SJM020500

The crimp sockets contacts (S), are made of copper-nickel alloy and are in compliance with M39029/22-192 standard (p.106)

MODULES M81714/60-16 SERIE II

M81714/60-16 SERIE II



Taille 16/16*
Size 16/16*

6 Contacts
(13 A)

MODULE A RETOUR

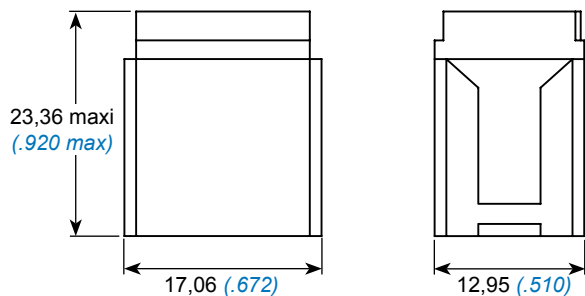

* taille interface / fût de sertissage
* mating end size / wire barrel size

Les contacts femelles (S) sont du type à sertir, en alliage de cuivre nickelé doré, normalisés M39029/22-193 (p.106)

FEEDBACK MODULE

Arrangement Layout	Référence MIL MIL Part number	Référence Amphenol Amphenol P/N
	M81714/60-16-01	SJM016100
	M81714/60-16-02	SJM016200
	M81714/60-16-03	SJM016300

The crimp sockets contacts (S), are made of copper-nickel alloy and are in compliance with M39029/22-193 standard (p.106)

MODULES M81714/60-12 SERIE II

M81714/60-12 SERIE II

Taille 12/12*
Size 12/12*

6 Contacts
(23 A)

MODULE A RETOUR

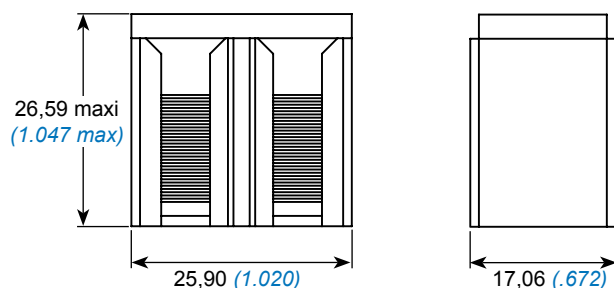

* taille interface / fût de sertissage
* mating end size / wire barrel size

Les contacts femelles (S) sont du type à sertir, en alliage de cuivre nickelé doré, normalisés M39029/22-605 (p.106)

FEEDBACK MODULE

Arrangement Layout	Référence MIL MIL Part number	Référence Amphenol Amphenol P/N
	M81714/60-12-01	SJM012100
	M81714/60-12-02	SJM012200
	M81714/60-12-03	SJM012300

The crimp sockets contacts (S), are made of copper-nickel alloy and are in compliance with M39029/22-605 standard (p.106)

MODULES DE MASSE M81714/63 SERIE II - A TIGE

M81714/63 SERIE II GROUND MODULES - STUD MOUNT

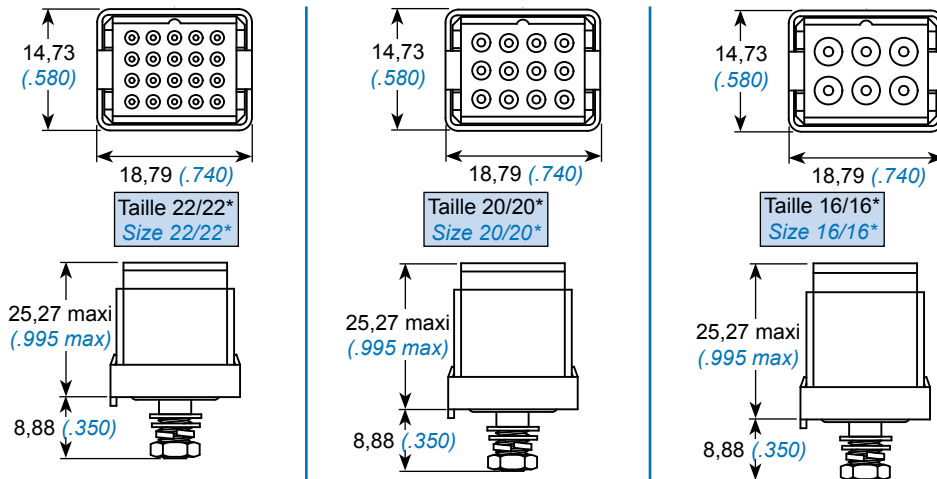

Contacts*		Revêtement Tige <i>Stud plating</i>	Référence MIL <i>MIL P/N</i>	Référence Amphenol <i>Amphenol P/N</i>
Taille* <i>Size*</i>	MIL-C-39029/..			
22/22	22-191	Or / <i>Gold</i>	M81714/63-22S	SJG022170
		Etain / <i>Tin</i>	/	SJG022100
20/20	22-192	Or / <i>Gold</i>	M81714/63-20S	SJG020170
		Etain / <i>Tin</i>	/	SJG020100
16/16	22-193	Or / <i>Gold</i>	M81714/63-16S	SJG016170
		Etain / <i>Tin</i>	/	SJG016100

* taille interface / fût de sertissage

* mating end size / wire barrel size

MODULES DE MASSE M81714/63 SERIE II A COLLERETTE

FLANGED M81714/63 SERIE II GROUND MODULES

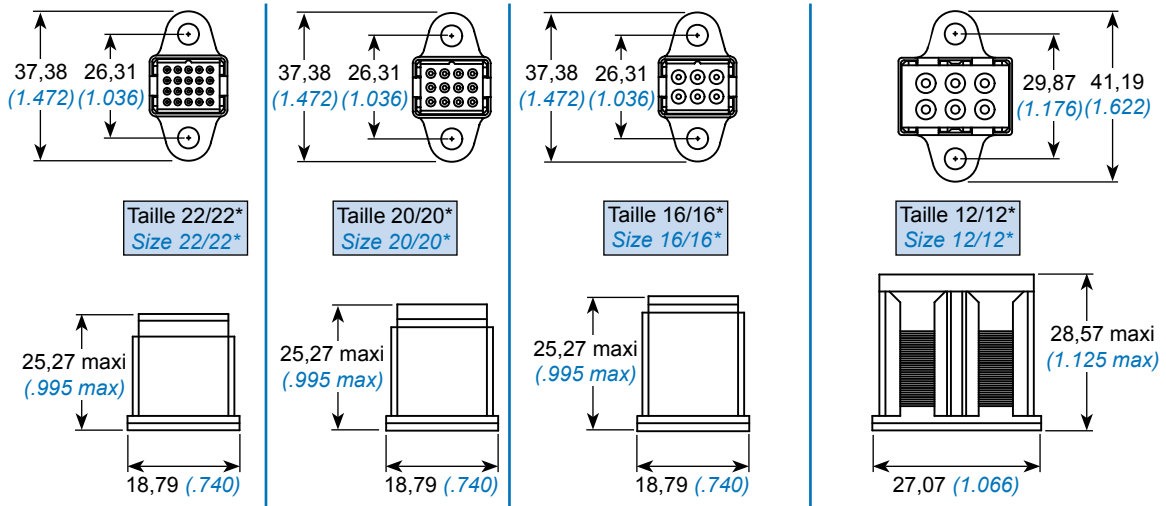

Contacts*		Revêtement Colletterte <i>Flange plating</i>	Référence MIL <i>MIL Part number</i>	Référence Amphenol <i>Amphenol P/N</i>
Taille* <i>Size*</i>	MIL-C-39029/..			
22/22	22-191	Or / <i>Gold</i>	M81714/63-22F	SJG022270
		Etain / <i>Tin</i>	/	SJG022200
20/20	22-192	Or / <i>Gold</i>	M81714/63-20F	SJG020270
		Etain / <i>Tin</i>	/	SJG020200
16/16	22-193	Or / <i>Gold</i>	M81714/63-16F	SJG016270
		Etain / <i>Tin</i>	/	SJG016200
12/12	22-605	Or / <i>Gold</i>	M81714/63-12F	SJG012270
		Etain / <i>Tin</i>	/	SJG012200

* taille interface / fût de sertissage

* mating end size / wire barrel size

REFERENTIEL

PART NUMBERING TABLE



Réf / P/N AALBF	Norme / Standard M81714/..	Page
SJG012200		64
SJG012270	63-12F	64
SJG016100		64
SJG016170	63-16S	64
SJG016200		64
SJG016270	63-16F	64
SJG020100		64
SJG020170	63-20S	64
SJG020200		64
SJG020270	63-20F	64
SJG022100		64
SJG022170	63-22S	64
SJG022200		64
SJG022270	63-22F	64
SJM012100	60-12-01	63
SJM012200	60-12-02	63
SJM012300	60-12-03	63
SJM016100	60-16-01	63
SJM016200	60-16-02	63
SJM016300	60-16-03	63
SJM020100	60-20-01	62
SJM020200	60-20-02	62
SJM020300	60-20-03	62
SJM020400	60-20-04	62
SJM020500	60-20-06	62
SJM022100	60-22-01	62
SJM022200	60-22-02	62
SJM022400	60-22-04	62
SJM022500	60-22-05	62
SJM022600	60-22-06	62
SJM022700	60-22-10	62

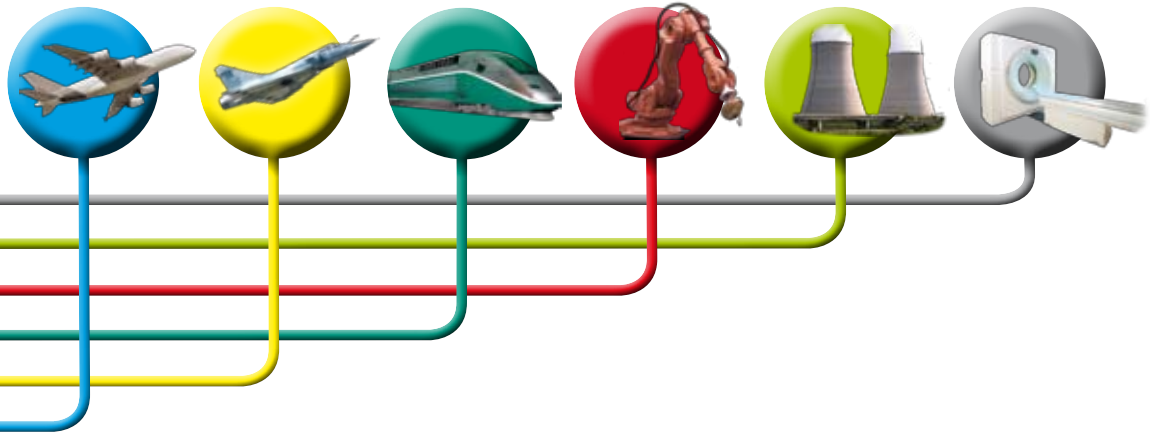

Modules Circulaires et Prolongateurs



Circular Modules and Splices

Edition 05/12

Amphenol Air LB

SYSTEMES DE CONNEXIONS ELECTRIQUES ET ELECTRONIQUES
ELECTRIC AND ELECTRONIC CONNECTION SYSTEMS

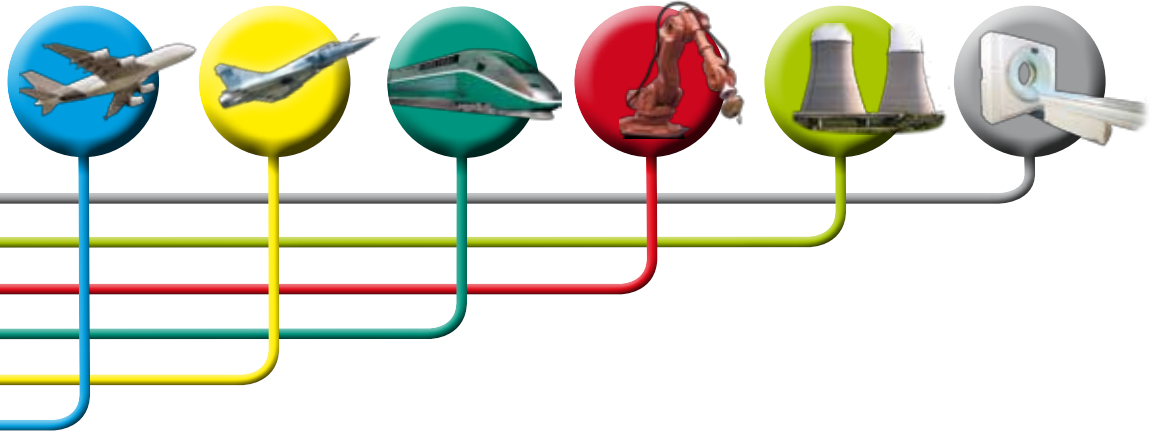

Modules Circulaires de Masse



Circular Grounding Modules

Edition 05/12

Amphenol Air LB

SYSTEMES DE CONNEXIONS ELECTRIQUES ET ELECTRONIQUES
ELECTRIC AND ELECTRONIC CONNECTION SYSTEMS

PRESENTATION PRESENTATION

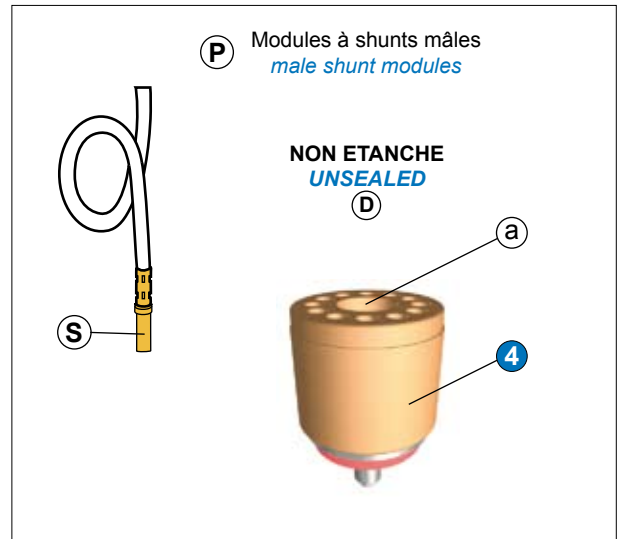
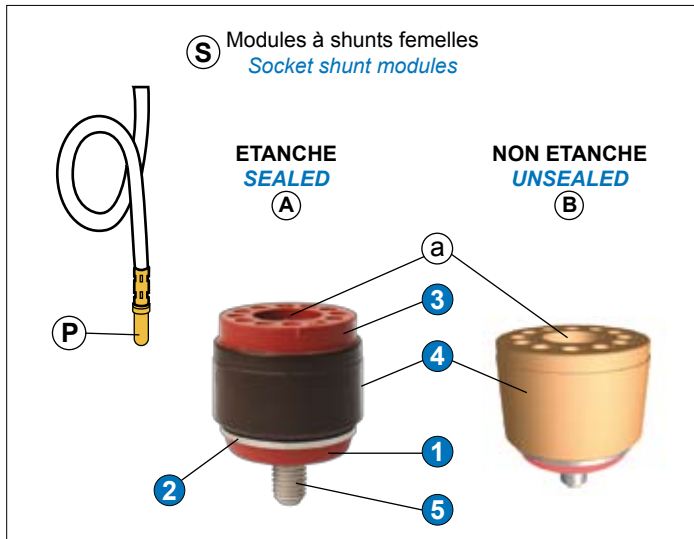

Les modules de masse circulaires sont constitués d'un shunt inséré à l'intérieur d'un boîtier isolant, monté sur une platine métallique munie d'une fixation imperdable M5 en acier cadmié bichromaté. Ils bénéficient de la même technologie et composants que les modules en barrette.
Ils sont disponibles en 2 versions : étanche et non étanche

Circular grounding modules consist of an inserted shunt in an insulating shell, mounted on a metallic plate with M5 captive fixation in cadmium dichromated plated steel. The same technology and components as for the rail modules is used.
Two versions are available : sealed and unsealed.

(A) et (B) Shunts femelles (S) à l'intérieur du boîtier pour contacts mâles à sertir (P), conformes à la normes **NF L53-105, NAS 1749 et EN 3155-016**.

(A) and (B) socket shunts (S) inside the shell for pin crimp contacts (P) comply with **NF L53-105, NAS 1749 and EN 3155-016 standards**.

(C) et (D) Shunts mâles (P) à l'intérieur du boîtier pour contacts femelles à sertir (S), conformes aux normes, **EN 3155-015, MIL-C-39029/63-368**.

(C) and (D) pin shunts (P) within the shell for crimp socket contacts (S) comply with **MIL-C-39029/63-368, and EN3155-015 standards**.

- (a) Entrée pour la vis CHc à tête cylindrique hexagonale
- 1 Joint torique d'étanchéité en silicone fluoré
- 2 Platine en laiton nickelé
- 3 Joint d'étanchéité en silicone
- 4 Boîtier isolant en résine thermoplastique
- 5 Vis M5

- (a) Hole for hexagonal fillister head screw accross 4 mm flat
- 1 Fluorinated silicone O-ring
- 2 Nickel cadmium plated brass plate
- 3 Silicone seal
- 4 Insulating shell in thermoplastic resin
- 5 M5 screw



CARACTERISTIQUES TECHNIQUES

TECHNICAL DATA



MECANIQUE

Boîtier	Matière	: Thermoplastique
	Protection	: Embase nickelée
Joint	Matière	: Elastomère silicone
Contact	Matière	: Alliage cuivreux
Protection		: Or
Endurance	Modules non étanches	: 50 cycles de montage/démontage du contact dans cavité
	Modules étanches	: 10 cycles de montage/démontage du contact dans cavité
Vibrations		: Sinusoïdales fréquence de 10 à 2000 Hz accélération 10 g. 3h/axe, discontinuité $\leq 1 \mu s$
Chocs		: 100 g, 6 ms (3 chocs dans 3 directions)
Rétention contacts		: 6,7 daN

RESISTANCE AUX FLUIDES

(uniquement ASNE 0425 ABS 1599)

Tenue	: Conforme EN3708
Étanchéité traversée	: EN2591 test 314

CLIMATIQUE

Température d'utilisation	: -55°C à +125°C
Endurance	: 1000h à 125°C
Résistance Brouillard salin	: 96h

ELECTRIQUE

Tension de tenue :	
- au niveau de la mer	: 1500 V eff. 50 Hz
- 14 000 mètres	: 350 V rms
Résistance d'isolement	: \geq à 5 000 M Ω à 25°C
Intensité maxi du contact	: 7,5 A
Résistance de contact	: \leq 4 m Ω

MECHANICAL

Shell	Material	: Thermoplastic
	Plating	: Nickel plated recept.
Seal	Material	: Silicon elastomer
Contact	Material	: Copper alloy
	Plating	: Gold
Endurance	Not sealed modules	: 50 complete mounting/unmounting cycles of contacts into the cavity
	Sealed modules	: 10 complete mounting/unmounting cycles of contacts into the cavity
Vibrations		: Sinusoidal frequency from 10 to 2000 Hz acceleration 10 g. 3h/axe, discontinuity $\leq 1 \mu s$
Shocks		: 100 g, 6 ms (3 shocks in 3 directions)
Contact retention	: size 20	: 6,7 daN

RESISTANCE TO FLUIDS

(only ASNE 0425 ABS 1599)

Fluid resistance	: as per EN3708
Feedthru sealing	: EN2591 test 314

ENVIRONMENT

Operating temperature	: -55°C to +125°C
Endurance	: 1000h à 125°C
Salt spray resistance	: 96h

ELECTRICAL

Dielectric withstanding voltage :	
- at sea level	: 1500 VRMS
- 14 000 meters	: 350 V rms
Insulation resistance	: \geq at 5000 M Ω at 25°C
Maximum contact current rating	: 7,5 A
Contact resistance	: \leq 4 m Ω

MODULES CIRCULAIRES POUR CONTACTS MALES CIRCULAR MODULES FOR PIN CONTACTS



Contacts mâles à sertir (P)

Suivant Normes : NF L 53-105, NAS 1749, EN 3155-016

Pin crimp contacts (P)

As per NF L 53-105, NAS 1749, EN 3155-016 standards

NON ETANCHE

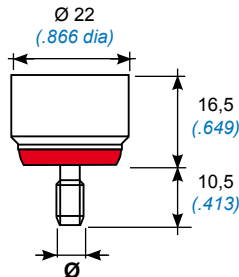

Taille 20
Size 20

12 Contacts
(7,5 A)

UNSEALED

MODULE	Ø	OUTIL / TOOL	CONTACT
001174 240 00	M5	002014 000 61 ⁽¹⁾	001104 200 02
001174 230 00	10.32 UNF 2A	002015 000 61 ⁽²⁾	

Couple de serrage / Torque : 0,25 mdaN
Masse / Weight : 16 g

ETANCHE

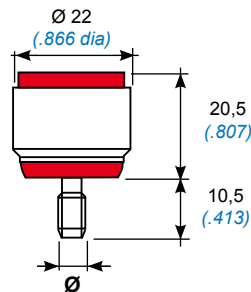

SEALED

MODULE	Ø	OUTIL / TOOL	CONTACT
001174 260 00	M5	002014 000 61 ⁽¹⁾	001104 200 02
001174 250 00	10.32 UNF 2A	002015 000 61 ⁽²⁾	

Couple de serrage - Torque : 0,25 mdaN
Masse / Weight : 17,2 g

MODULES CIRCULAIRES POUR CONTACTS FEMELLES CIRCULAR MODULES FOR SOCKET CONTACTS

Contacts femelles à sertir (S)

Suivant Normes : ASNE 0396, EN 3155-015, MIL-C-39029/63-368

Socket crimp contacts (S)

As per ASNE 0396, EN 3155-015, MIL-C-39029/63-368 standards

NON ETANCHE

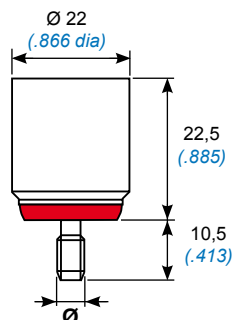

Taille 20
Size 20

12 Contacts
(7,5 A)
ASNE 0425-A-2001

UNSEALED

MODULE	Ø	OUTIL / TOOL	CONTACT
001174 200 00	.1900-32 UNF 2A	002015 000 61 ⁽²⁾	001704 201 02 001704 202 02

Couple de serrage - Torque : 0,4 à 0,5 mdaN
Masse / Weight : 17,5 g

MODULES CIRCULAIRES A RESISTANCE - CONTACTS FEMELLES

CIRCULAR MODULES WITH RESISTORS - SOCKET CONTACTS

Contacts femelles à sertir (S)

Suivant Normes : ASNE 0396, EN 3155-015, MIL-C-39029/63-368

Socket crimp contacts (S)

As per ASNE 0396, EN 3155-015, MIL-C-39029/63-368 standards

NON ETANCHE

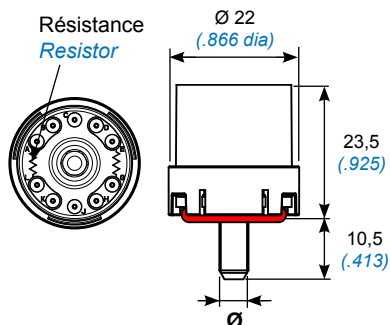

Taille 20
Size 20

10 Contacts
(7,5 A)

ABS1599 A 20 D

UNSEALED

MODULE	Ø	OUTIL / TOOL	CONTACT
3108 8003 502	.1900-32 UNF 2A	002015 000 61 ⁽²⁾	001704 201 02 001704 202 02

Masse / Weight : 16,5 g

Résistance / Resistor : 120 Ω 0,5 W +/- 5%

ETANCHE

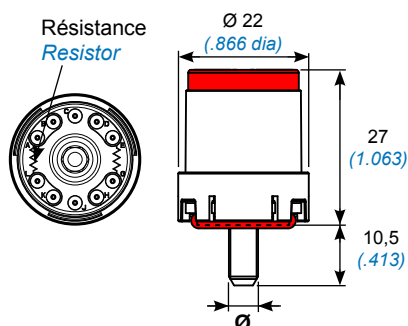

Taille 20
Size 20

10 Contacts
(7,5 A)

ABS1599 A 20 E

SEALED

MODULE MODULE	Ø	OUTIL TOOL	CONTACT
3108 8002 502	.1900-32 UNF 2A	002015 000 61 ⁽²⁾	001704 201 02 001704 202 02

Masse / Weight : 17,5 g

Résistance / Resistor : 120 Ω 0,5 W +/- 5%

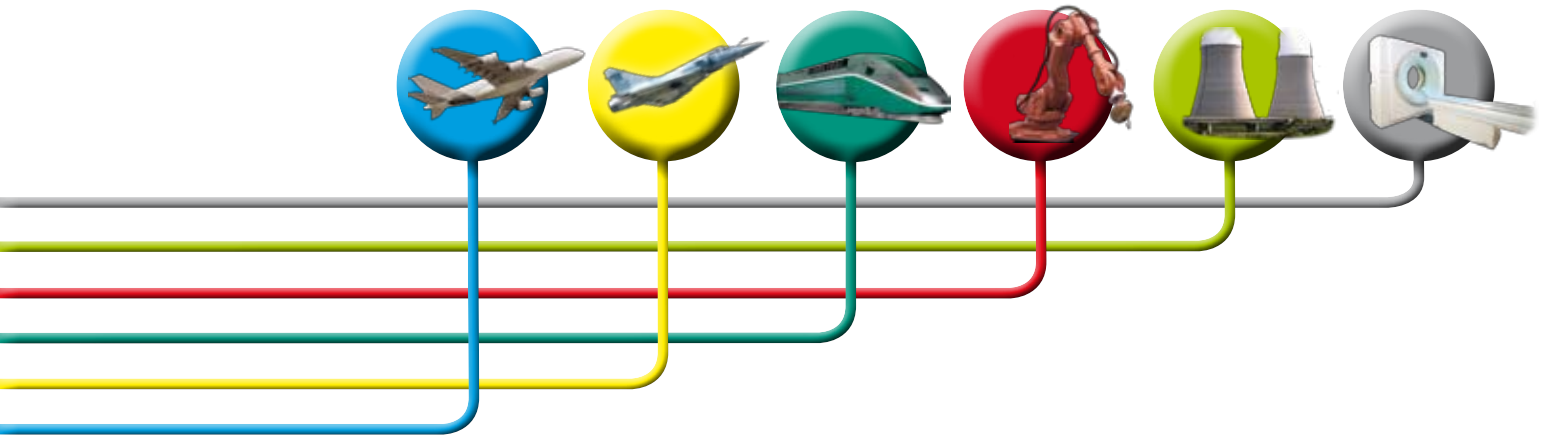

Modules Circulaires de Traversée - Fûts à souder



***Grounding - Solder Cup
Circular Modules***

Edition 05/12

Amphenol Air LB

SYSTEMES DE CONNEXIONS ELECTRIQUES ET ELECTRONIQUES
ELECTRIC AND ELECTRONIC CONNECTION SYSTEMS

PRESENTATION PRESENTATION



MODULES CIRCULAIRES DE TRAVERSEE

Les modules circulaires de traversée sont une évolution des modules équipés de fûts à souder. Ils bénéficient de la même technologie de surmoulage.

Ces modules sont une alternative offrant l'avantage de recevoir des contacts amovibles (P) et (S) :
48 contacts à sertir - 24 mâles taille 20 normalisés EN3155-016M2018 (côté surmoulage) et 24 femelles spécifiques (côté face dure).



CIRCULAR FEEDTHRU MODULE

Circular feedthru modules are an evolution of the solder cup circular modules. They are made with the same Amphenol Air LB overmoulding technology.

They have been designed to receive 48 removable crimp contacts, 24 pin (P) contacts standardized EN3155-016M2018 to be mounted into the grommet side, and 24 specific socket contacts (S) to be inserted on the opposite side.

MODULES CIRCULAIRES - FUTS A SOUDER

Les modules circulaires avec fûts à souder bénéficient de la technologie de surmoulage Amphenol Air LB, assurant une étanchéité parfaite sur toutes les cavités de contact.

Ils reçoivent 20 ou 40 contacts mâles à sertir (P) taille 22 normalisés NFL 53105-1, EN3155-016M2222 et sont équipés de contacts femelles (S) intégrés avec fûts à souder.

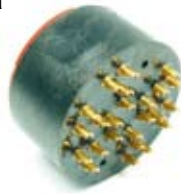

SOLDER CUP CIRCULAR MODULES

Circular feedthru module has been designed with the best know-how of Amphenol Air LB overmoulding technology, ensuring a perfect sealing on the contact cavities.

They have been designed to receive 20 or 40 pin contacts (P) size 22, standardized NFL 53105-1, EN3155-016M2222, and are equipped with socket contacts (S) with solder cups.

CARACTERISTIQUES TECHNIQUES TECHNICAL DATA

MECANIQUE

Boîtier	Matière	: Thermoplastique
	Protection	: Embase nickelée
Joint	Matière	: Elastomère silicone
Contact	Matière	: Alliage cuivreux
Protection		: Or
Vibrations		: Sinusoïdales fréquence de 5 à 2000 Hz accélération 10 g. 3h/axe, discontinuité $\leq 1 \mu s$
Chocs		: 100 g, 6 ms (3 chocs dans 3 directions)
Rétention contacts	taille 22	: 4 daN
	taille 20	: 6,7 daN

RESISTANCE AUX FLUIDES

(uniquement ASNE 0425 ABS 1599)

Tenue	: Conforme EN3708
Etanchéité traversée	: EN2591 test 314

CLIMATIQUE

Température d'utilisation	: -55°C à +175°C
Endurance	: 1000h à 175°C
Chaleur humide	: 21j à 40°C, 93% HR
Résistance Brouillard salin	: 96h

ELECTRIQUE

Tension de tenue :	
- au niveau de la mer	: 1500 V rms
- sous 1 mètre	: 350 V rms
Résistance d'isolement	: \geq à 5 000 M Ω
Intensité maxi du contact	: 7,5 A
Résistance de contact	: \leq 4 m Ω

MECHANICAL

Shell	Material	: Thermoplastic
	Plating	: Nickel plated recept.
Seal	Material	: Silicon elastomer
Contact	Material	: Copper alloy
	Plating	: Gold
Vibrations		: Sinusoidal frequency from 5 to 2000 Hz acceleration 10 g. 3h/axe, discontinuity $\leq 1 \mu s$
Shocks		: 100 g, 6 ms (3 shocks in 3 directions)
Contact retention	size 22	: 4 daN
	size 20	: 6,7 daN

RESISTANCE TO FLUIDS

(only ASNE 0425 ABS 1599)

Fluid resistance	: as per EN3708
Feedthru sealing	: EN2591 test 314

ENVIRONMENT

Operating temperature	: -55°C to +175°C
Endurance	: 1000h à 175°C
Damp heat	: 21j to 40°C, 93% HR
Salt spray resistance	: 96h

ELECTRICAL

Dielectric withstanding voltage :	
- at sea level	: 1500 V rms
- under 1 meter	: 350 V rms
Insulation resistance	: \geq at 5000 M Ω
Maximum contact current rating	: 7,5 A
Contact resistance	: \leq 4 m Ω

MODULE CIRCULAIRE DE TRAVERSEE FEEDTHRU CIRCULAR MODULE



Taille 20
Size 20

24 Contacts
(7,5 A)

vue face grommet
grommet side view

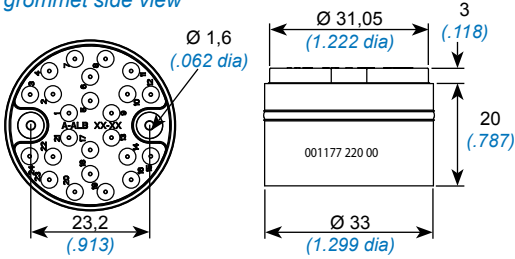

MODULE	CONTACTS	
	face grommet grommet side	face dure / hard side
001177 220 00	Ⓟ 001104 200 02	Ⓢ 001704 220 02

Exemple d'application du module
Module application example

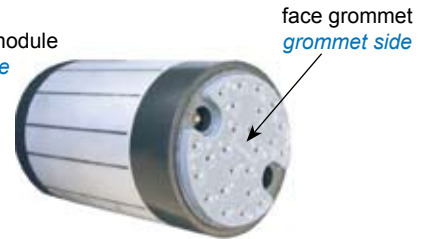

MODULE CIRCULAIRE - CONTACTS FUT A SOUDER CIRCULAR MODULE - SOLDER CUP CONTACTS

Contacts mâles à sertir Ⓟ

Référence : 001104 100 02

Suivant Normes : NF L 53105-1, EN3155-016M2222
et NSA 937910 EA 2200

Pin crimp contacts Ⓟ

P/N : 001104 100 02

As per NF L 53105-1, EN3155-016M2222 and
NSA 937910 EA 2200 standards

Taille 22
Size 22

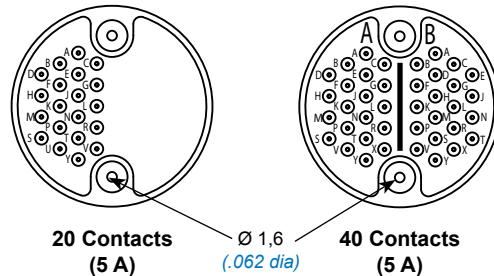
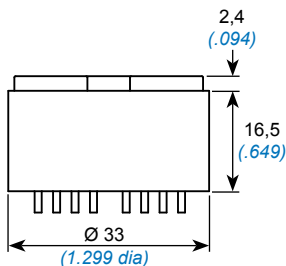

ARRANGEMENT / LAYOUT	
20 contacts	40 contacts
001177 110 00	001177 100 00

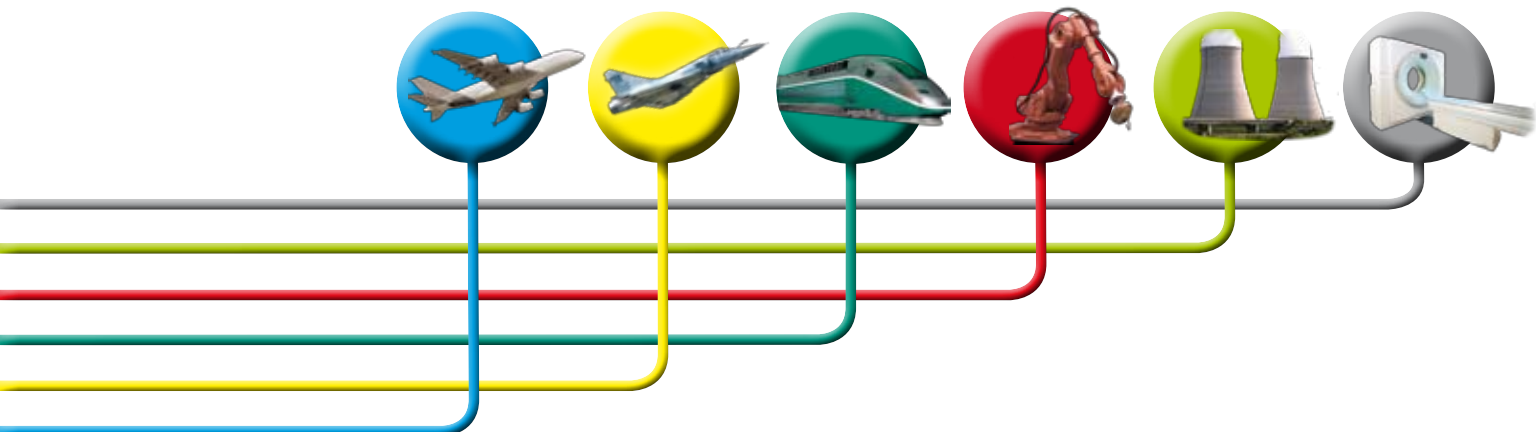

Prolongateurs et bornes ABS & NSA



ABS & NSA Terminal blocks & Splices

Edition 05/12

Amphenol Air LB

SYSTEMES DE CONNEXIONS ELECTRIQUES ET ELECTRONIQUES
ELECTRIC AND ELECTRONIC CONNECTION SYSTEMS

CARACTERISTIQUES TECHNIQUES TECHNICAL DATA



MECANIQUE

Module	Matière	: Thermoplastique
Joint	Matière	: Elastomère silicone
Contact	Matière	: Alliage de cuivre
	Protection	: Or sur nickel
Endurance		: 10 cycles de montage/démontage du contact dans cavité
Rétention contacts		: taille 22 : 5,4 daN taille 20 : 9 daN taille 16 : 11,4 daN

CLIMATIQUE

Température d'utilisation : -55°C à +175°C

ELECTRIQUE

Tension de tenue :		
au niveau de la mer	: tailles 22, 20 et 16 :	1 500 V rms
altitude 12 000 m	: tailles 22, 20 et 16 :	500 V rms
Résistance d'isolement	: \geq à	5 000 M Ω
Intensité maxi du contact	: taille 22 :	5 A
	taille 20 :	7,5 A
	taille 16 :	13 A
Résistance de contact	: taille 22 :	\leq 5 m Ω
Résistance de contact	: taille 20 :	\leq 4 m Ω
Résistance de contact	: taille 16 :	\leq 3 m Ω

MECHANICAL

Module	Material	: Thermoplastic
Grommet	Material	: Silicon Elastomer
Contact	Material	: Copper alloy
	Plating	: Gold on nickel
Endurance		: 10 complete mounting/unmounting cycles of contacts into the cavity
Contact retention		: size 22 : 5,4 daN size 20 : 9 daN size 16 : 11,4 daN

ENVIRONMENT

Operating temperature : -55°C to +175°C

ELECTRICAL

Dielectric withstanding voltage :		
at sea level	: sizes 22, 20 and 16 :	1 500 V rms
12 000 meters	: sizes 22, 20 and 16 :	1 000 V rms
Insulation resistance	: \geq at	5 000 M Ω
Max contact current rating	: size 22 :	5 A
	size 20 :	7,5 A
	size 16 :	13 A
Contact resistance	: size 22 :	\leq 5 m Ω
Contact resistance	: size 22 :	\leq 4 m Ω
Contact resistance	: size 22 :	\leq 3 m Ω

PRESENTATION DES PROLONGATEURS PRESENTATION OF SPLICES

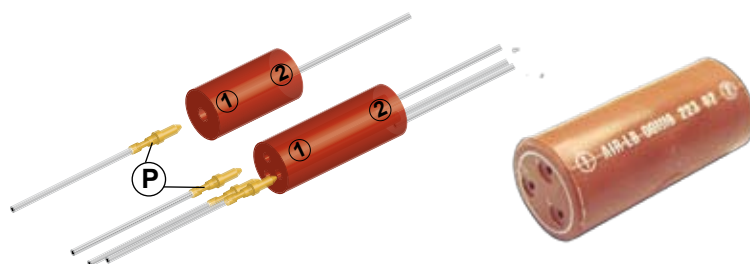

Contacts - tailles 22, 20 et 16
Contacts - sizes 22, 20 and 16

AIR LB REF.00111

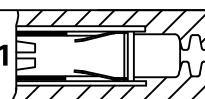

Les prolongateurs **Amphenol Air LB** sont constitués de contacts femelles (S) insérés à l'intérieur d'un manchon en alliage cuivreux et d'un surmoulage en élastomère silicone fluoré. Ils bénéficient de la même technologie que les modules. Ils sont étanches et existent en 1, 2, 3, 4 circuits.

Amphenol Air LB splices consist of female contacts (S) inserted in a thermosetting resin and fluorinated silicone elastomer sleeve. The technology used is the same as for modules. They are sealed and are available in 1, 2, 3, 4 circuits.

Ces prolongateurs reçoivent des contacts mâles à sertir (P), conformes aux normes NF L53-105, NAS 1749 et EN 3155-016 (page 105).

These in-line junctions are suitable for male crimp contacts (P) which comply with NF L53-105, NAS 1749, and EN 3155-016 standards (page 105).

Pour toute demande de prolongateurs constitués de contacts mâles (P) insérés à l'intérieur du manchon et pouvant recevoir des contacts femelles à sertir (S) : merci de nous consulter.

For Splices with pin contacts (P) inserted in the sleeve and suitable for female crimp contacts (S) : please consult us.













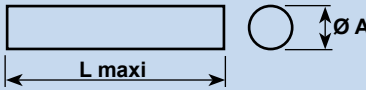
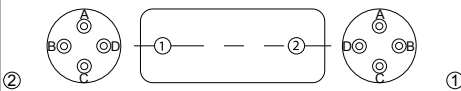
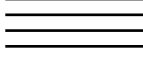

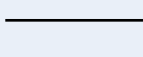
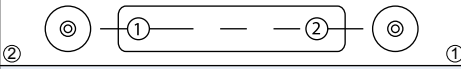
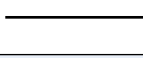

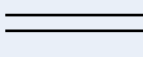
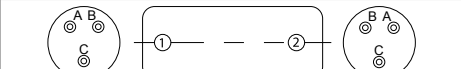
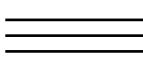

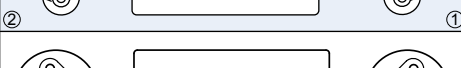
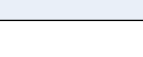
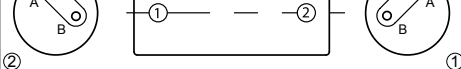
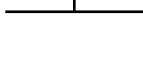
PROLONGATEURS POUR CONTACTS CABLE CUIVRE

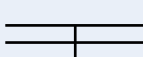
SPLICES FOR COPPER CABLE CONTACTS

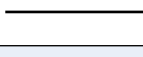

Système de Projection Européen

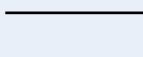
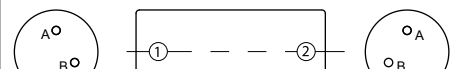
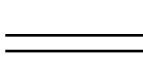
European Projection System

PROLONGATEUR <i>SPLICE</i> 	Circuit	CONTACT Taille Size		L maxi	Ø A	REFERENCE PART NUMBER	Masse Weight
		①	②				g
		22	22	29 (.141)	13 (.511)	001119 108 02	10
		20	20	29 (.141)	6 (.236)	001119 201 02	1,7
		20	20	29 (.141)	6 (.236)	001119 201 30**	/
		20	20	29 (.141)	12,7 (.500)	001119 202 02	6,1
		20	20	29 (.141)	12,7 (.500)	001119 203 02	6,8
		20	20	29 (.141)	6 (.236)	001119 204 02	/
		20	20	29 (.141)	12,7 (.500)	001119 222 02	6,4
		20	20	29 (.141)	12,7 (.500)	001119 223 02	6,9
		20	20	29 (.141)	12,7 (.500)	001119 224 02	6,9
		16	16	37 (.1456)	7,2 (.283)	001119 301 02	2,9
		16	16	37 (.1456)	15 (.589)	001119 302 02	11,7
		16	16	37 (.1456)	15 (.589)	001119 322 02	11,7
		16	20	33,5 (.1320)	12,7 (.500)	001119 501 02	7,7
		22	20	29 (.141)	6 (.236)	001119 503 02	2,15

** prolongateur avec silicone fluoré

** Splice with fluorinated silicon

PROLONGATEURS POUR CONTACTS CÂBLE ALUMINIUM

SPLICES FOR ALUMINUM CABLE CONTACTS



Prolongateurs pour contacts câble aluminium selon ABS 1380

Splices designed for ABS 1380 aluminum cable contacts

Système de Projection Européen

European Projection System

PROLONGATEUR SPLICE	CIRCUIT CIRCUIT	CONTACT Taille Size		L maxi	Ø A	REFERENCE PART NUMBER	Masse Weight
		①	②				g
		22	22	35 (.1377)	13 (.511)	001119 168 02	10
		22	22	35 (.1377)	13 (.511)	001119 158 02	10
		20	20	35 (.1377)	13 (.511)	001119 252 02	10
		20	20	35 (.1377)	12,7 (.500)	001119 282 02	8

PROLONGATEURS A COMPOSANTS

SPLICES WITH COMPONENTS

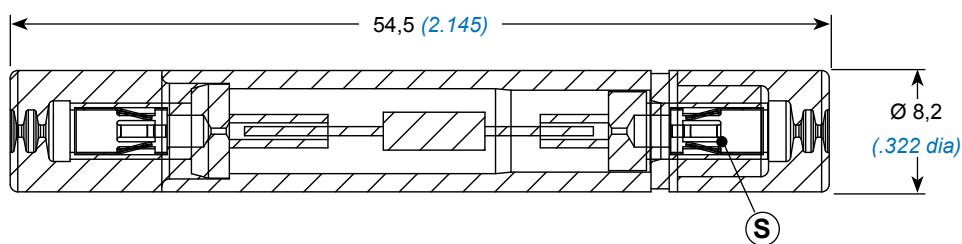

Taille / Size 20

Section 0,21 à 0,93 mm² - Gauges 18-20-22-24 AWG

Les prolongateurs à composants **Amphenol Air LB** sont constitués de 2 contacts femelles (S) insérés à l'intérieur d'un manchon en résine thermodurcissable et en élastomère de silicone fluoré. Ils bénéficient de la même technologie que les modules. Ils sont étanches et existent en plusieurs modèles équipés de composants (diode, fusible, résistance ...)

Amphenol Air LB splices with integrated components consist of 2 female contacts (S) inserted in a thermosetting resin and fluorinated silicon elastomer sleeve. The technology used is the same as for modules. They are sealed and are available in several models with components (diode, fuse, resistor ...).

Ils reçoivent des contacts mâles à sertir (P), conformes aux normes NF L53-105, NAS 1749 et EN 3155-016 (page 105).

They are suitable for crimp male contacts (P) which comply with NF L53-105, NAS 1749 et EN 3155-016 standards (page 105).

PROLONGATEURS A DIODES INSEREES

SPLICES WITH INSERTED DIODES



Caractéristiques DIODE <i>DIODE data</i>		REFERENCE <i>PART NUMBER</i>	
Courant maximum à l'état passant I_o <i>Maximum transitional current I_o</i>	Tension inversée VRM <i>Reverse voltage VRM</i>	DIODE	PROLONGATEUR diode insérée <i>SPLICE with inserted diode</i>
$I_o = 2 \text{ A}$ à $t_o 25^\circ$	VRM = 200 Volts	1 N 5551	001119 702 02
$I_o = 1 \text{ A}$ à $t_o 140^\circ\text{C}$	VRM = 600 Volts	1 N 5619	001119 703 02
-	-	1 N 5207	001119 705 02
$I_o = 1 \text{ A}$ à $t_o 75^\circ\text{C}$	VRM = 1000 Volts	1 N 4007	001119 711 02
$I_o = 5 \text{ A}$	VRM = 1000 Volts	1N5554	001119 731 02
$I_o = 1 \text{ A}$ à $t_o 75^\circ\text{C}$	VRM = 50 Volts	1 N 4001	001119 741 02
$I_o = 3 \text{ A}$ à $t_o 50^\circ\text{C}$	VRM = 400 Volts	BY 252	001119 746 02
$I_o = 5 \text{ A}$ à $t_o 60^\circ\text{C}$	VRM = 800 Volts	BY550	001119 751 02
$I_o = 1 \text{ A}$	VRM = 600 Volts	1N4005	001119 765 02
$I_o = 2 \text{ A}$	VRM = 1000 Volts	BYW56	001119 768 02
$I_o = 3 \text{ A}$	VRM = 1300 Volts	BY255	001119 779 02
$I_o = 8,4 \text{ A}$	VRM = 111 Volts	Transil 1,5 KE 130 CA	001119 788 02
$I_o = 8,4 \text{ A}$	VRM = 111 Volts	Transil 1,5 KE 180 CA	001119 790 02

* Diodes fournies par le client
Autres diodes, merci de nous consulter

* Diodes supplied by the customer
For other diodes, please consult us



PROLONGATEURS A FUSIBLES INSEREES

SPLICES WITH INSERTED FUSES

Caractéristique FUSIBLE <i>FUSE data</i>		REFERENCE <i>PART NUMBER</i>	
Courant maximal à l'état passant I_o <i>Maximum transitional current I_o</i>	Tension inversée VRM <i>Reverse voltage VRM</i>	FUSIBLE <i>FUSE</i>	PROLONGATEUR fusible inséré <i>IN-LINE JUNCTION with inserted fuse</i>
$I_o = 0,6 \text{ A}$	VRM = 125 Volts	Mini-Fuse DMP IN	001119 745 02
$I_o = 1 \text{ A}$	VRM = 125 Volts	PICOFUSE Serie 255	001119 801 02
$I_o = 2 \text{ A}$	VRM = 125 Volts	PICOFUSE Serie 255	001119 802 02
$I_o = 3 \text{ A}$	VRM = 125 Volts	Little Fuse temporisé	001119 810 02

Autres fusibles, merci de nous consulter

For other fuses, please consult us

PROLONGATEURS A RESISTANCES INSERES

SPLICES WITH INSERTED RESISTANCES



Caractéristique Résistance <i>Resistor data</i>	REFERENCE <i>PART NUMBER</i>	
	Résistance <i>Resistor</i>	PROLONGATEUR résistance insérée <i>SPLICE WITH inserted resistor</i>
620 Ω 0,5W ±5%	SFR25	001119 732 02
39 KΩ 0,5 W ±5%	rcmm 05 k	001119 754 02
100 KΩ 0,5 W ±5%	rcmm 05 k2	001119 755 02
75 Ω 0,5 W ±5%	rcmm 05 k2	001119 756 02
470 Ω 0,5 W ± 5%	rcmm 02	001119 762 02
510 Ω 1/2 W ±2%	NK4	001119 763 02
2,2 KΩ 0,5 W	rcmm 02	001119 764 02
680 Ω 2,5W	w21	001119 769 02
10 KΩ 0,5W	10KΩ 0,5W	001119 773 02
2,2 KΩ 0,25W ±5%	-	001119 774 02
150 Ω 0,25 W ±5%	-	001119 775 02
150 KΩ 0,25W ±5%	-	001119 776 02
5.5 KΩ 0,25 W ±0,5%	Sfernice NT4S	001119 777 02
100 KΩ 0,25 W ± 1 %	Sfernice NT4S	001119 778 02
1 KΩ 0,25 W 5%	VR25 série E12	001119 780 02
5,6 KΩ 0,5W ±1%	5,6KΩ 0,5W	001119 782 02*
1 KΩ 5 W	1KΩ 0,5W	001119 784 02*
560 Ω 0,5 W ±1%	560Ω 0,5W	001119 785 02
511 Ω 2W ±5%	RLP2	001119 792 02
20 KΩ 0,25 W ±1%	série MFR4	001119 812 02
10 KΩ ±5% R5	Vishay / BCcomponent serie PR02	001119 814 02
47 KΩ ±5% R5	Vishay / BCcomponent serie PR02	001119 815 02
1 MΩ ±5% R5	Vishay / BCcomponent serie PR01	001119 816 02

Autres résistances, merci de nous consulter

For other resistors, please consult us

PRESENTATION DES BORNES

PRESENTATION OF TERMINALS

(NF L53-105)
(NAS 1749)
EN 3155-016
Tailles 20-16-12
Sizes 20-16-12

Ces bornes à jonction individuelle sont constituées d'un contact femelle (S) protégé par un joint en élastomère de silicone amovible. Elles sont disponibles pour être vissées ou serties sur une platine, en une seule version de contact : Contact femelle (S) pour contact mâle à sertir (P) conforme aux normes NF L53-105, NAS 1749 et EN 3155-016 (page 105).

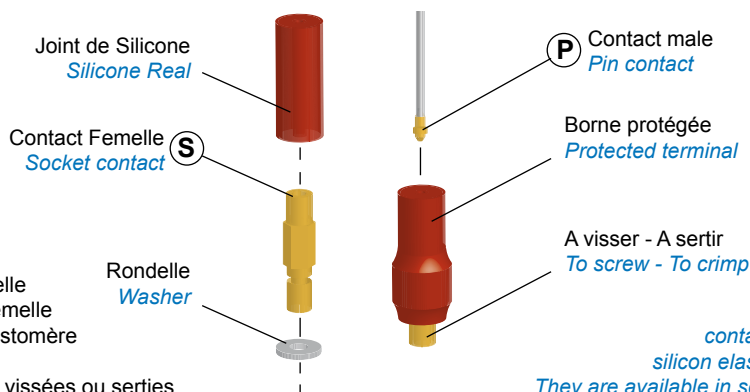

A visser - A sertir
To screw - To crimp

These individual junction terminals consist of one socket contact (S) protected by a removable silicon elastomer seal. They are available in screw or crimp type on a plate in only one contact version : Socket contact (S) for crimp pin contact (P) complies with NF L53-105, NAS 1749 and EN 3155-016 standards (page 105).

BORNES A VISSER SCREW MOUNTING TERMINALS



Taille 20
Size 20

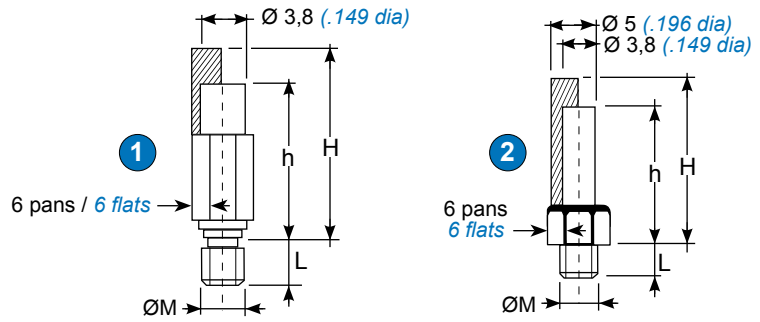

Rep. Ident.	Ø M	6 pans de x sur plat x across 6 flats	L		Sans joint Without seal	h		Avec joint With seal	H		Rondelle Washer	Joint Seal
			mm	inch		mm	inch		mm	inch		
1	M 3	4	4,5	.177	001120 203 02	12,5	.492	001120 209 02	16,5	.649	-	001100 281 81
2	0.1380-32 UNC	5	3	.118	001120 601 02	12	.472	001120 205 02	16	.630	-	
	0.1640-32 UNC		10,3	.405	001120 603 02			001120 223 02			001120 610 02	
	0.1640-32 UNC		3,43	.135	001120 604 02			001120 215 02			001120 610 02	
2*	0.1380-32 UNC	5	3	.118	001120 601 04	12	.472	001120 205 04	16	.630	-	
	0.1640-32 UNC		3,43	.135	001120 604 04			001120 215 04			001120 610 04	

* Borne laiton nickelé - Contact femelle cupro-béryllium

* Nickel plated brass terminal - Cupro-beryllium female contact

Taille 16
Size 16

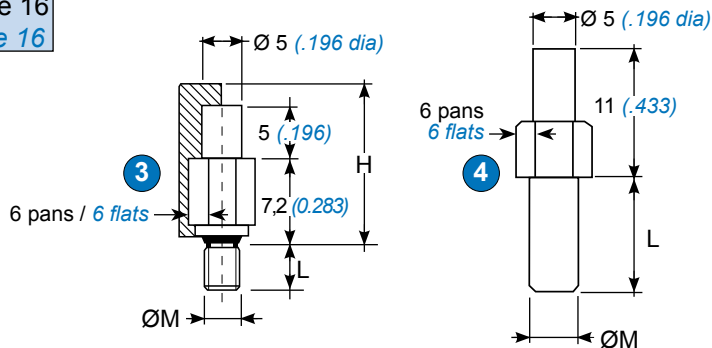

Rep. Ident.	Ø M	6 pans de x sur plat x across 6 flats	L		Sans joint Without seal	h		Avec joint With seal	H		Joint Seal
			mm	inch		mm	inch		mm	inch	
3	M 3	5,5	4,5	.177	001120 304 02	12,2	.480	001120 314 02	18,2	.716	001100 388 81
4	0.1640-32 UNC	6	10,6	.417	001120 305 02						

Taille 12
Size 12

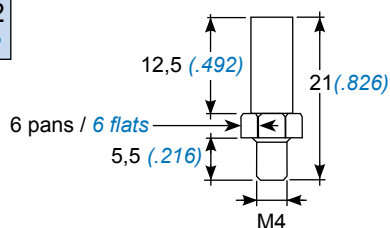

Réf. : 001120 402 02
P/N

BORNES A SERTIR

CRIMP TERMINALS



Taille 20
Size 20

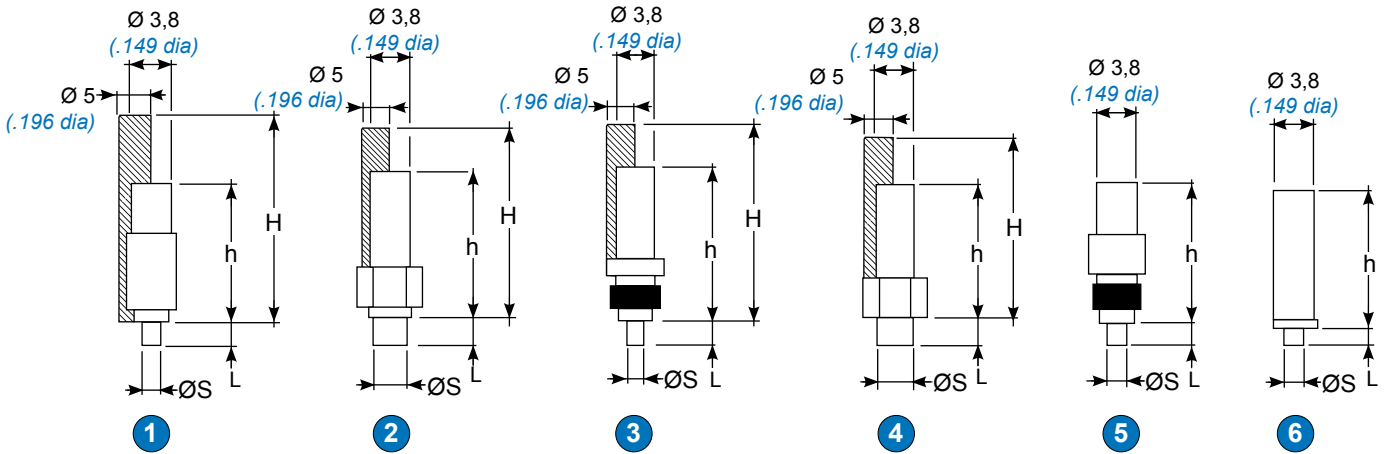

Rep. Ident.	Ø S	L		Sans joint Without seal		Avec joint With seal		H		Rondelle Washer	Joint Seal
		mm	inch	mm	inch	mm	inch	mm	inch		
1	1,5	2	.078	001120 201 02	12,5	.492	001120 217 02	18,5	.728	-	001100 279 81
2	3	2,53	.100	001120 606 02	13	.511	001120 226 02	17	.669	001120 610 02	001100 280 81
3	1,5	2	.078	001120 612 02	13,8	.543	001120 212 02	17,5	.688		
4	3	2,6	.102	001120 614 02	12	.472	001120 214 02	16	.630		
	3	3	.118	001120 618 04	12	.472					
5	1,5	2	.078	001120 230 02	12,5	.492					
6	1,5	1,3	.051	001120 216 04	12,5	.492					

* Borne laiton nickelé
Contact femelle cupro-béryllium

* Nickel plated brass terminal
Cupro-beryllium female contact

Taille 16
Size 16

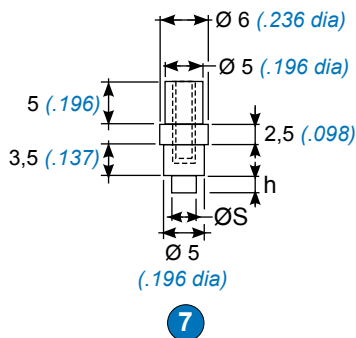

Rep. Ident.	Ø S		h		Sans joint Without seal
	mm	inch	mm	inch	
7	1,5	.059	2,0	.078	001120 321 02
	2,0	.078	1,8	.070	001120 324 02
	3,0	.118	2,0	.078	001120 325 02

Rondelle / Washer

Dorée / Gold plated
001120 610 02
Nickelée / Nickel plated
001120 610 04

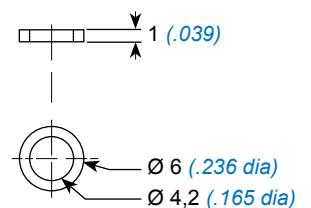

REFERENTIEL

PART NUMBERING TABLE



Réf / P/N AALBF	Page
001100 279 81	85
001100 280 81	85
001100 281 81	84
001100 388 81	84
001119 108 02	80
001119 158 02	80
001119 168 02	80
001119 201 02	80
001119 201 30	80
001119 202 02	80
001119 203 02	80
001119 204 02	80
001119 222 02	81
001119 223 02	81
001119 224 02	81
001119 252 02	81
001119 282 02	81
001119 301 02	81
001119 302 02	81
001119 322 02	81
001119 501 02	81
001119 503 02	81
001119 702 02	82
001119 703 02	82
001119 705 02	82
001119 711 02	82
001119 731 02	82
001119 732 02	83
001119 741 02	82
001119 745 02	82
001119 746 02	82
001119 751 02	82
001119 754 02	83
001119 755 02	83
001119 756 02	83
001119 762 02	83
001119 763 02	83
001119 764 02	83
001119 765 02	82
001119 768 02	82
001119 769 02	83
001119 773 02	83
001119 774 02	83
001119 775 02	83
001119 776 02	83
001119 777 02	83
001119 778 02	83

Réf / P/N AALBF	Page
001119 779 02	82
001119 780 02	83
001119 782 02	83
001119 784 02	83
001119 785 02	83
001119 788 02	82
001119 790 02	82
001119 792 02	83
001119 801 02	83
001119 802 02	83
001119 810 02	83
001119 812 02	83
001119 814 02	83
001119 815 02	83
001119 816 02	83
001120 201 02	85
001120 203 02	84
001120 205 02	84
001120 205 04	84
001120 209 02	84
001120 212 02	85
001120 214 02	85
001120 215 02	84
001120 215 04	84
001120 216 02	85
001120 217 02	85
001120 223 02	84
001120 226 02	85
001120 230 02	85
001120 304 02	84
001120 305 02	84
001120 314 02	84
001120 321 02	85
001120 324 02	85
001120 325 02	85
001120 601 02	84
001120 601 04	84
001120 603 02	84
001120 604 02	84
001120 604 04	84
001120 606 02	85
001120 610 02	84 - 85
001120 610 04	84
001120 612 02	85
001120 614 02	85
001120 618 02	85

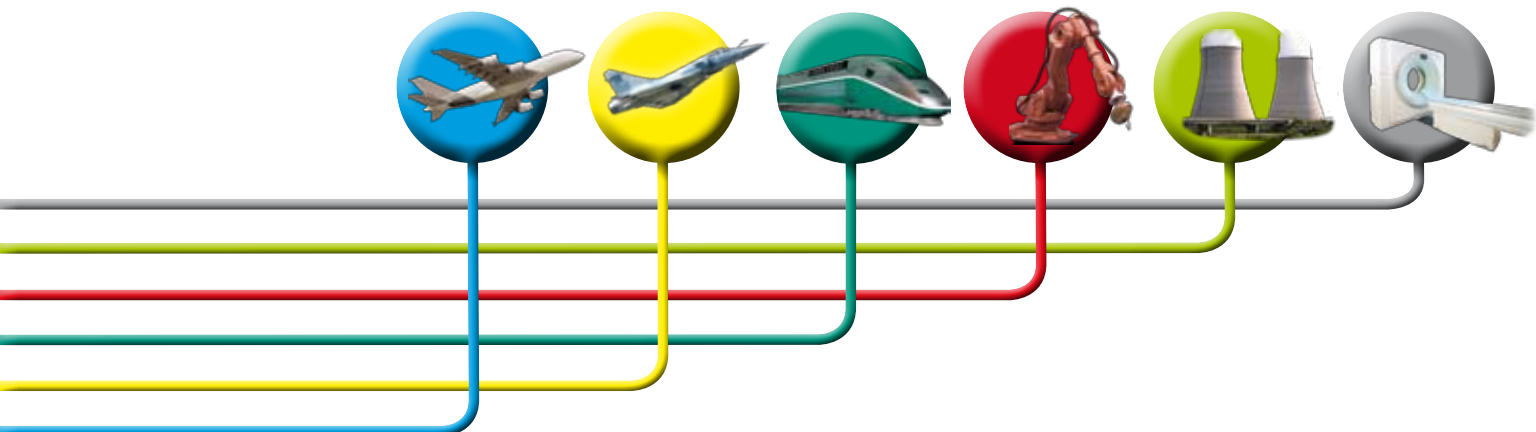

Prolongateurs MIL-81714 & dérivés



MIL-81714 & derived Splices

Edition 05/12

Amphenol Air LB

SYSTEMES DE CONNEXIONS ELECTRIQUES ET ELECTRONIQUES
ELECTRIC AND ELECTRONIC CONNECTION SYSTEMS

PRESENTATION

PRESENTATION



Les prolongateurs simples, doubles ou électroniques ont été conçus pour permettre des interventions rapides et efficaces.

Les versions simples et doubles sont normalisées MIL-T-81714/11&12, hautement résistantes aux fluides et aux températures.

Les versions électroniques (à composants intégrés) sont disponibles avec une large gamme de fusibles, diodes, résistances et autres condensateurs...et bénéficient également d'une normalisation : MIL-T-81714/24. Ces prolongateurs vous permettent de modifier vos caractéristiques électriques sur un faisceau sans qu'il vous soit nécessaire de passer par vos ateliers.

Les modèles les plus courants vous sont présentés dans les pages qui suivent, mais nous répondrons à toute demande spécifique.

Single and dual splices and electronic splices are designed to provide a quick and efficient solution to customer wiring requirements.

Single and dual splices meet MIL-T-81714/11&12 requirements and are highly resistant to temperature and fluids.

TJSE electronic modules can be supplied with a wide variety of diodes, resistors, capacitors, and fuses within the splice itself. TJSE electronic splices meet the electronic parameters of MIL-T-81714/24 and allow customers to incorporate system modifications into a wire bundle, avoiding changes in panels on board.

Typical examples are represented on the following pages, but customer specific designs are possible.

CARACTERISTIQUES TECHNIQUES

TECHNICAL DATA

MECANIQUE

Module Matière : Thermoplastique
Grommet Matière : Bande silicone
Contact Matière : Alliage cuivreux
Protection : Or selon MIL-G-45204
Vibrations : Taille 20 et 16 : EIA-364-28D, condition de test V, E
Taille 12 : EIA-364-D, méthode 28, condition de test V

RESISTANCE AUX FLUIDES

Tenue : suivant MIL-T-81714/11 & 12

CLIMATIQUE

Température d'utilisation : -65°C à +125°C

ELECTRIQUE

Tension de tenue au niveau de la mer : 1 500 V.R.M.S.
Résistance d'isolement : > 5000 mΩ
Résistance de contacts :
taille 20 : 9 mΩ
taille 16 : 5 mΩ
Intensité maxi du contact :
taille 20 : 7,5 A
taille 16 : 13 A
taille 12 : 23 A

MECHANICAL

Module Material : Thermoplastic
Grommet Material : Silicon rubber
Contact Material : Copper alloy
Plating : Gold plated as per MIL-G-45204
Vibrations : Size 20 and 16 : EIA-364D-028D, test condition V, E
Size 12 : EIA-364-D, Method 28, test condition V

RESISTANCE TO FLUIDS

Resistance : as per MIL-T-81714/11 & 12

ENVIRONMENT

Operating temperature : -65°C to +125°C

ELECTRICAL

Dielectric withstanding voltage at sea level : 1 500 V.R.M.S.
Insulation resistance : > 5000 mΩ
Contact resistance :
size 20 : 9 mΩ
size 16 : 5 mΩ
Maximum contact current rating :
size 20 : 7,5 A
size 16 : 13 A
size 12 : 23 A

PROLONGATEURS M81714 SERIE I

SERIE I M81714 SPLICES



Pour Contacts Mâles

For Pin Contacts

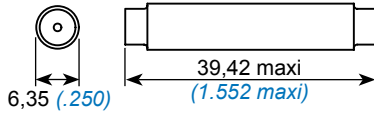

Contacts* Contacts*	Référence MIL MIL Part number	Référence Amphenol Amphenol P/N
16/22	M81714/11-22D	TJS322700
16/20	M81714/11-20D	TJS320700
14/16	M81714/11-16D	TJS316700
12/12	M81714/11-12D	TJS312700

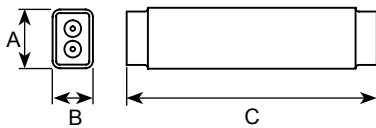

Arrangement* Layout*	Référence MIL MIL Part number	Référence Amphenol Amphenol P/N	A	B	C	
	16/22	M81714/12-22D1	TJS322701	10,16 .400	6,98 .275	39,42 1.552
	16/20	M81714/12-20D1	TJS320701			
	14/16	M81714/12-16D1	TJS316701	12,7 .500	7,61 .300	50,59 1.922
	16/22	M81714/12-22D2	TJS322702	10,16 .400	6,98 .275	39,42 1.552
	16/20	M81714/12-20D2	TJS320702			
	14/16	M81714/12-16D2	TJS316702	12,7 .500	7,61 .300	50,59 1.922

* Voir Contacts page 106

* See Contacts on page 106

PROLONGATEURS M81714 SERIE II

SERIE II M81714 SPLICES

Pour Contacts Femelles

For Socket Contacts

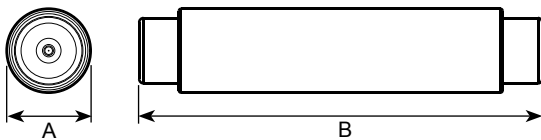

Référence MIL MIL Part number	Référence Amphenol Amphenol P/N	A max	B max
M81714/65-16-1	SJS316700	8,22 .324	36,88 1.452
M81714/65-20-1	SJS320700	7,36 .290	36,42 1.434
M81714/65-22-1	SJS322700	5,84 .230	33,27 1.310

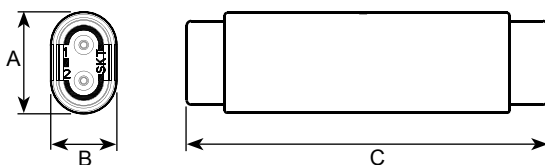

Référence MIL MIL Part number	Référence Amphenol Amphenol P/N	A max	B max	C max
M81714/65-16-2	SJS316701	13,91 .548	7,72 .304	36,27 1.428
M81714/65-20-2	SJS320701	12,21 .481	6,88 .271	
M81714/65-22-2	SJS322701	9,75 .384	5,18 .204	33,57 1.322

PROLONGATEURS PUSH & PULL 1 CONTACT

1 CONTACT PUSH & PULL SPLICES



FICHE

PLUG

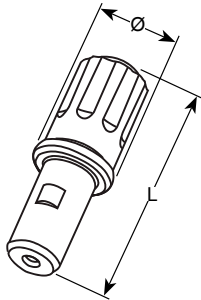

Taille Size	Contact M39029/...	Couleur Color	Référence Amphenol avec contact Amphenol P/N with contact	Référence Amphenol sans contact Amphenol P/N without contact	Ø	L	L accouplé mated	Masse Weight g
12	56-353	Bleu / Blue	SJS512101	SJS512100	11,4 .449	30,71 1.209	45,22 1.78	2,18
		Rouge / Red	SJS512111	SJS512110				
16	56-352	Bleu / Blue	SJS716101	SJS716100	9,9 .39	28,19 1.11	43,2 1.701	1,39
		Rouge / Red	SJS716111	SJS716110				
20	56-351	Vert / Green	SJS720101	SJS720100	17,8 .701	27,41 1.079	42,7 1.681	4,31
		Jaune / Yellow	SJS720111	SJS720110				

Les contacts femelles (S) sont du type à sertir, en alliage de cuivre nickelé doré, normalisés M39029 (p.106)

The crimp socket contacts (S), are made of copper nickel alloy and are in compliance with M39029 standard (p.106)

EMBASE

RECEPTACLE

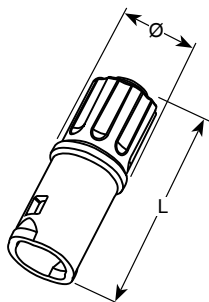

Taille Size	Contact M39029/...	Couleur Color	Référence Amphenol avec contact Amphenol P/N with contact	Référence Amphenol sans contact Amphenol P/N without contact	Ø	L	L accouplé mated	Masse Weight g
12	58-365	Bleu / Blue	SJS512201	SJS512200	12,40 .488	28,40 1.118	45,22 1.78	1,79
		Rouge / Red	SJS512211	SJS512210				
16	58-364	Bleu / Blue	SJS716201	SJS716200	10,90 .429	26,90 1.059	42,01 1.654	1,50
		Rouge / Red	SJS716211	SJS716210				
20	58-363	Vert / Green	SJS720201	SJS720200	9,90 .390	26,11 1.028	43,21 1.701	1,19
		Jaune / Yellow	SJS720211	SJS720210				

Les contacts mâles (P) sont du type à sertir, en alliage de cuivre nickelé doré, normalisés M39029 (p.106)

The crimp pin contacts (P), are made of copper nickel alloy and are in compliance with M39029 standard (p.106)

PROLONGATEURS PUSH & PULL 3 CONTACTS

3 CONTACTS PUSH & PULL SPLICES

FICHE

PLUG

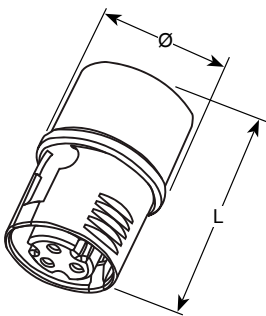

Taille Size	Contact M39029/...	Couleur Color	Clé* Key*	Référence Amphenol avec contact Amphenol P/N with contact	Référence Amphenol sans contact Amphenol P/N without contact	Ø	L	L accouplé mated	Masse Weight g
16	56-352	Rouge / Red	A	SJS816101	SJS816100	17,8 .701	28,4 1.118	41 1.614	5,3
		Blanc / White	B	SJS816111	SJS816110				
		Bleu / Blue	C	SJS816121	SJS816120				
20	56-351	Rouge / Red	A	SJS820101	SJS820100	17,8 .701	27,41 1.079	42,7 1.681	4,31
		Blanc / White	B	SJS820111	SJS820110				
		Bleu / Blue	C	SJS820121	SJS820120				

Les contacts femelles (S) sont du type à sertir, en alliage de cuivre nickelé doré, normalisés M39029 (p.106)

The crimp socket contacts (S), are made of copper nickel alloy and are in compliance with M39029 standard (p.106)

* Pour détrompage à l'accouplement

* For Polarizing mating

EMBASE

RECEPTACLE

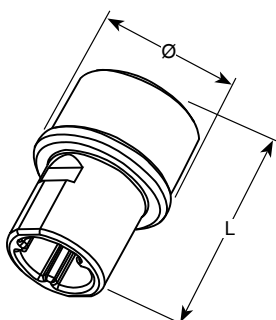

Taille Size	Contact M39029/...	Couleur Color	Clé* Key*	Référence Amphenol avec contact Amphenol P/N with contact	Référence Amphenol sans contact Amphenol P/N without contact	Ø	L	L accouplé mated	Masse Weight g
16	58-364	Rouge / Red	A	SJS816201	SJS816200	17,8 .701	26,11 1.028	41 1.614	4,59
		Blanc / White	B	SJS816211	SJS816210				
		Bleu / Blue	C	SJS816221	SJS816220				
20	58-363	Rouge / Red	A	SJS820201	SJS820200	17,8 .701	25,1 .988	42,7 1.681	3,71
		Blanc / White	B	SJS820211	SJS820210				
		Bleu / Blue	C	SJS820221	SJS820220				

Les contacts mâles (P) sont du type à sertir, en alliage de cuivre nickelé doré, normalisés M39029 (p.106)

The crimp pin contacts (P), are made of copper nickel alloy and are in compliance with M39029 standard (p.106)

* Pour détrompage à l'accouplement

* For Polarizing mating

PROLONGATEURS TWIST & LOCK 2 CONTACTS

2 CONTACTS TWIST & LOCK SPLICES



FICHE

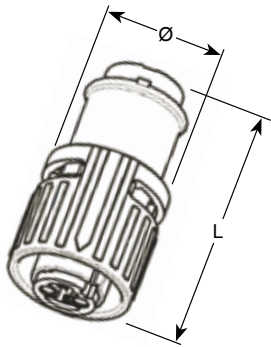

PLUG

Taille Size	Contact M39029/...	Couleur Color	Référence Amphenol avec contact <i>Amphenol P/N with contact</i>	Référence Amphenol sans contact <i>Amphenol P/N without contact</i>	Ø	L	L accouplé mated	Masse Weight g	Support Cradle
22D	57-354	Noir / <i>Black</i>	SJS830251	SJS830250	9,96 .392	19,48 .767	32 1.26	1,50	-

Les contacts femelles (S) sont du type à sertir, en alliage de cuivre nickelé doré, normalisés M39029 (p.106)

The crimp socket contacts (S), are made of copper nickel alloy and are in compliance with M39029 standard (p.106)

EMBASE

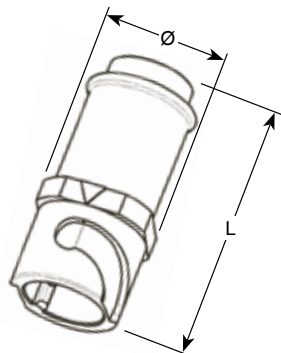

RECEPTACLE

Taille Size	Contact M39029/...	Couleur Color	Référence Amphenol avec contact <i>Amphenol P/N with contact</i>	Référence Amphenol sans contact <i>Amphenol P/N without contact</i>	Ø	L	L accouplé mated	Masse Weight g	Support Cradle
22D	58-360	Noir / <i>Black</i>	SJS830271	SJS830270	8,08 .318	18,8 .740	32 1.26	1,11	-

Les contacts mâles (P) sont du type à sertir, en alliage de cuivre nickelé doré, normalisés M39029 (p.106)

The crimp pin contacts (P), are made of copper nickel alloy and are in compliance with M39029 standard (p.106)

PROLONGATEURS TWIST & LOCK 3 CONTACTS

3 CONTACTS TWIST & LOCK SPLICES

FICHE

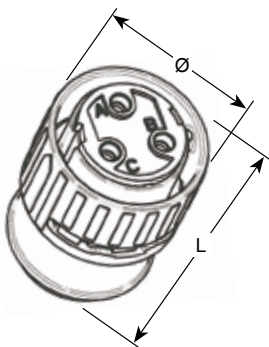

PLUG

Taille Size	Contact M39029/...	Couleur Color	Clé* Key*	Référence Amphenol avec contact <i>Amphenol P/N with contact</i>	Référence Amphenol sans contact <i>Amphenol P/N without contact</i>	Ø	L	L accouplé mated	Masse Weight g	Support Cradle
16	57-358	Blanc <i>White</i>	-	SJS840311	SJS840310	15,29 .602	19,91 .784	32,26 1.27	2,61	SJS445000
		Noir <i>Black</i>	ALT**	SJS840341	SJS840340			32 1.26		
22D	57-354	Noir <i>Black</i>	-	SJS830211	SJS830210	9,96 .392	19,79 .779	32,26 1.27	1,50	-

Les contacts femelles (S) sont du type à sertir, en alliage de cuivre nickelé doré, normalisés M39029 (p.106)

The crimp socket contacts (S), are made of copper nickel alloy and are in compliance with M39029 standard (p.106)

* Pour détrompage à l'accouplement

* For Polarizing mating

** Détrompage Universel acceptant les clés A, B et C

** Universal polarizing, compatible with A, B and C keys

EMBASE

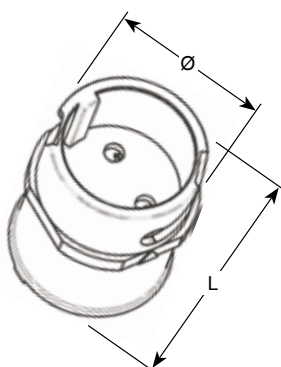

RECEPTACLE

Taille Size	Contact M39029/...	Couleur Color	Clé* Key*	Référence Amphenol avec contact <i>Amphenol P/N with contact</i>	Référence Amphenol sans contact <i>Amphenol P/N without contact</i>	Ø	L	L accouplé mated	Masse Weight g	Support Cradle
16	58-364	Blanc <i>White</i>	-	SJS840301	SJS840300	13,21 .520	19,18 .755	32,26 1.270	1,90	SJS445000
		Noir <i>Black</i>	ALT**	SJS840351	SJS840350				3,29	
		Blanc <i>White</i>	-	SJS840321 (structure / panel)	SJS840320 (structure / panel)					-
		Noir <i>Black</i>	ALT**	SJS840331 (structure / panel)	SJS840330 (structure / panel)					
22D	58-360	Noir <i>Black</i>	-	SJS830231	SJS830230	8,01 .318		32 1.2760	1,11	-

Les contacts mâles (P) sont du type à sertir, en alliage de cuivre nickelé doré, normalisés M39029 (p.106)

The crimp pin contacts (P), are made of copper nickel alloy and are in compliance with M39029 standard (p.106)

* Pour détrompage à l'accouplement

* For Polarizing mating

** Détrompage Universel acceptant les clés A, B et C

** Universal polarizing, compatible with A, B and C keys

PROLONGATEURS TWIST & LOCK 4 CONTACTS

4 CONTACTS TWIST & LOCK SPLICES



FICHE

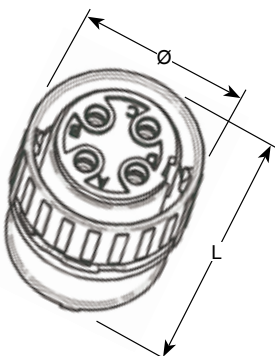

PLUG

Taille Size	Contact M39029/...	Couleur Color	Référence Amphenol avec contact <i>Amphenol P/N with contact</i>	Référence Amphenol sans contact <i>Amphenol P/N without contact</i>	Ø	L	L accouplé mated	Masse Weight g	Support Cradle
16	57-358	Blanc / <i>White</i>	SJS840411	SJS840410	15,29 .602	19,91 .784	32,26 1.27	2,69	SJS445000

Les contacts femelles (S) sont du type à sertir, en alliage de cuivre nickelé doré, normalisés M39029 (p.106)

The crimp socket contacts (S), are made of copper nickel alloy and are in compliance with M39029 standard (p.106)

EMBASE

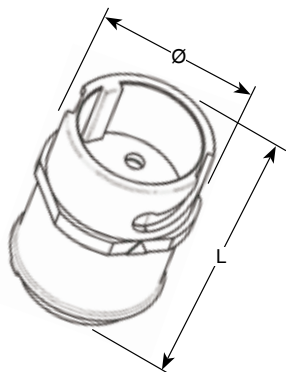

RECEPTACLE

Taille Size	Contact M39029/...	Couleur Color	Référence Amphenol avec contact <i>Amphenol P/N with contact</i>	Référence Amphenol sans contact <i>Amphenol P/N without contact</i>	Ø	L	L accouplé mated	Masse Weight g	Support Cradle
16	57-364	Blanc / <i>White</i>	SJS840401	SJS840400	13,97 .550	19,18 .755	32,26 1.27	1,90	SJS445000

Les contacts mâles (P) sont du type à sertir, en alliage de cuivre nickelé doré, normalisés M39029 (p.106)

The crimp pin contacts (P), are made of copper nickel alloy and are in compliance with M39029 standard (p.106)

PROLONGATEURS TWIST & LOCK 5 CONTACTS

5 CONTACTS TWIST & LOCK SPLICES

FICHE

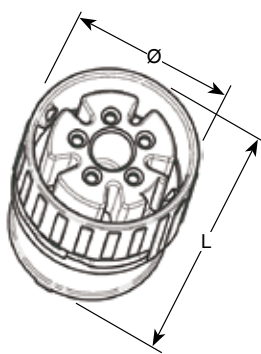

PLUG

Taille Size	Contact M39029/...	Couleur Color	Référence Amphenol avec contact <i>Amphenol P/N with contact</i>	Référence Amphenol sans contact <i>Amphenol P/N without contact</i>	Ø	L	L accouplé mated	Masse Weight g	Support Cradle
22D	57-354 femelle socket	Blanc / <i>White</i>	SJS860511	SJS860510	15,29 .602	18,85 .742	32,26 1.27	2,61	SJS445000
	58-360 mâle / pin		SJS870511	SJS870510				2,49	-

Les contacts mâles sont du type à sertir, en alliage de cuivre nickelé doré, normalisés M39029 (p.106)

The crimp pin contacts are made of copper nickel alloy and are in compliance with M39029 standard (p.106)

EMBASE

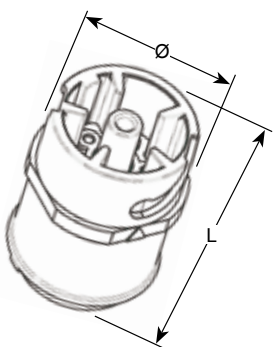

RECEPTACLE

Taille Size	Contact M39029/...	Couleur Color	Référence Amphenol avec contact <i>Amphenol P/N with contact</i>	Référence Amphenol sans contact <i>Amphenol P/N without contact</i>	Ø	L	L accouplé mated	Masse Weight g	Support Cradle
22D	58-360 mâle / pin	Blanc / <i>White</i>	SJS860501	SJS860500	13,97 .550	19,18 .755	32,26 1.27	2,49	SJS445000
			SJS860521 (structure / panel)	SJS860520 (structure / panel)	13,21 .520			3,60	-
	57-354 femelle socket		SJS870521	SJS870520	13,41 .528	18,90 .744	3,80	-	

Les contacts mâles sont du type à sertir, en alliage de cuivre nickelé doré, normalisés M39029 (p.106)

The crimp pin contacts are made of copper nickel alloy and are in compliance with M39029 standard (p.106)

PROLONGATEURS TWIST & LOCK 8 CONTACTS

8 CONTACTS TWIST & LOCK SPLICES



FICHE

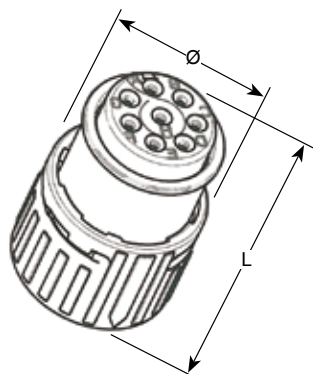

PLUG

Taille Size	Contact M39029/...	Couleur Color	Clé* Key*	Référence Amphenol avec contact Amphenol P/N with contact	Référence Amphenol sans contact Amphenol P/N without contact	Ø	L	L accouplé mated	Masse Weight g	Support Cradle
22D	57-354	Noir / Black	A	SJS831100	SJS830100	13,31 .524	19,23 .757	32 1.26	1,73	SJS883000
		Vert / Green	B	SJS831101	SJS830101					
		Jaune / Yellow	C	SJS831102	SJS830102					

Les contacts femelles (S) sont du type à sertir, en alliage de cuivre nickelé doré, normalisés M39029 (p.106)

* Pour détrompage à l'accouplement

The crimp socket contacts (S), are made of copper nickel alloy and are in compliance with M39029 standard (p.106)

* For Polarizing mating

EMBASE

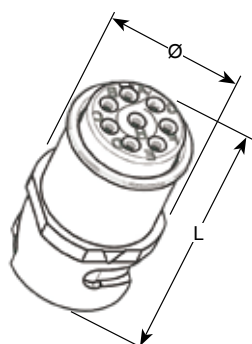

RECEPTACLE

Taille Size	Contact M39029/...	Couleur Color	Clé* Key*	Référence Amphenol avec contact Amphenol P/N with contact	Référence Amphenol sans contact Amphenol P/N without contact	Ø	L	L accouplé mated	Masse Weight g	Support Cradle
22D	58-360	Noir / Black	A	SJS831200	SJS830200	11,38 .448	19,51 .768	32 1.26	1,36	SJS883000
		Vert / Green	B	SJS831201	SJS830201					
		Jaune / Yellow	C	SJS831202	SJS830202					
		Noir / Black	A	SJS831220 (structure / panel)	SJS830220 (structure / panel)			32,26 1.27	2,52	-
		Vert / Green	B	SJS831221 (structure / panel)	SJS830221 (structure / panel)					
		Jaune / Yellow	C	SJS831222 (structure / panel)	SJS830222 (structure / panel)					

Les contacts mâles (P) sont du type à sertir, en alliage de cuivre nickelé doré, normalisés M39029 (p.106)

* Pour détrompage à l'accouplement

The crimp pin contacts (P), are made of copper nickel alloy and are in compliance with M39029 standard (p.106)

* For Polarizing mating

PROLONGATEURS TWIST & LOCK 9 CONTACTS

9 CONTACTS TWIST & LOCK SPLICES

FICHE

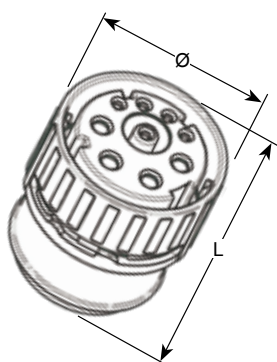

PLUG

Taille Size	Contact M39029/...	Couleur Color	Référence Amphenol avec contact Amphenol P/N with contact	Référence Amphenol sans contact Amphenol P/N without contact	Ø	L	L accouplé mated	Masse Weight g	Support Cradle
4x16 5x22D	57-354 57-258	Blanc / White	SJS860911	SJS860910	20,24 .714	21 .741	32,26 1.27	3,29	SJS991000

Les contacts femelles (S) sont du type à sertir, en alliage de cuivre nickelé doré, normalisés M39029 (p.106)

The crimp socket contacts (S), are made of copper nickel alloy and are in compliance with M39029 standard (p.106)

EMBASE

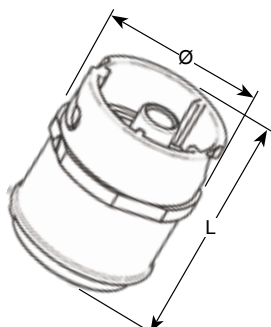

RECEPTACLE

Taille Size	Contact M39029/...	Couleur Color	Référence Amphenol avec contact Amphenol P/N with contact	Référence Amphenol sans contact Amphenol P/N without contact	Ø	L	L accouplé mated	Masse Weight g	Support Cradle
4x16 5x22D	58-360 58-364	Blanc / White	SJS860901	SJS860900	16,54 .651	19,17 .755	32,26 1.27	3,20	SJS991000

Les contacts mâles (P) sont du type à sertir, en alliage de cuivre nickelé doré, normalisés M39029 (p.106)

The crimp pin contacts (P), are made of copper nickel alloy and are in compliance with M39029 standard (p.106)

SUPPORTS CRADLES

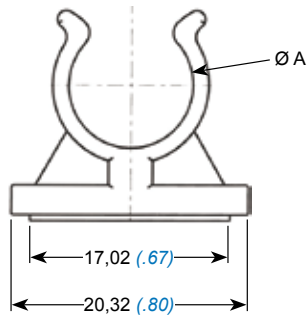
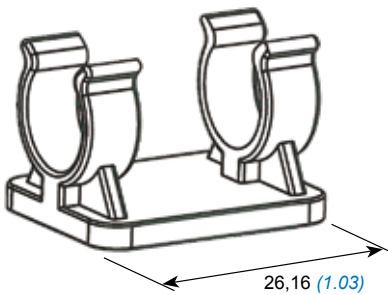

Référence P/N	Couleur Color	Ø A	Masse Weight g
SJS445000	Blanc White	12,57 (.495)	2,69
SJS883000	Noir Black	10,67 (.420)	2,80
SJS991000	Blanc White	15,11 (.595)	

REFERENTIEL PART NUMBERING TABLE

Réf / P/N AALBF	Réf / P/N M81714/..	Page
SJS316700	65-16-1	90
SJS316701	65-16-2	90
SJS320700	65-20-1	90
SJS320701	65-20-2	90
SJS322700	65-22-1	90
SJS322701	65-22-2	90
SJS445000		92-93-95
SJS512100		91
SJS512101		91
SJS512110		91
SJS512111		91
SJS512200		91
SJS512201		91
SJS512210		91
SJS512211		91
SJS716100		91
SJS716101		91
SJS716110		91
SJS716111		91
SJS716200		91
SJS716201		91
SJS716210		91
SJS716211		91
SJS720100		91
SJS720101		91
SJS720110		91
SJS720111		91
SJS720200		91
SJS720201		91
SJS720210		91
SJS720211		91
SJS816100		91
SJS816101		91
SJS816110		91
SJS816111		91
SJS816120		91
SJS816121		91
SJS816200		91
SJS816201		91
SJS816210		91
SJS816211		91

Réf / P/N AALBF	Réf / P/N M81714/..	Page
SJS816220		91
SJS816221		91
SJS820100		91
SJS820101		91
SJS820110		91
SJS820111		91
SJS820120		91
SJS820121		91
SJS820200		91
SJS820201		91
SJS820210		91
SJS820211		91
SJS820220		91
SJS820221		91
SJS830100		94
SJS830101		94
SJS830102		94
SJS830200		94
SJS830201		94
SJS830202		94
SJS830210		92
SJS830211		92
SJS830220		94
SJS830221		94
SJS830222		94
SJS830230		92
SJS830231		92
SJS830250		92
SJS830251		92
SJS830270		92
SJS830271		92
SJS831100		94
SJS831101		94
SJS831102		94
SJS831200		94
SJS831201		94
SJS831202		94
SJS831220		94
SJS831221		94
SJS831222		94
SJS840300		92

Réf / P/N AALBF	Réf / P/N M81714/..	Page
SJS840301		92
SJS840310		92
SJS840311		92
SJS840320		92
SJS840321		92
SJS840330		92
SJS840331		92
SJS840340		92
SJS840341		92
SJS840350		92
SJS840351		92
SJS840400		93
SJS840401		93
SJS840410		93
SJS840411		93
SJS860500		93
SJS860501		93
SJS860510		93
SJS860511		93
SJS860520		93
SJS860521		93
SJS860900		100
SJS860901		100
SJS860910		100
SJS860911		100
SJS870510		93
SJS870511		93
SJS870520		93
SJS870521		93
SJS883000		94-95
SJS991000		94-95
TJS312700	11-12D	90
TJS316700	11-16D	90
TJS316701	12-16D1	90
TJS316702	12-16D2	90
TJS320700	11-20D	90
TJS320701	12-20D1	90
TJS320702	12-20D2	90
TJS322700	11-22D	90
TJS322701	12-22D1	90
TJS322702	12-22D2	90

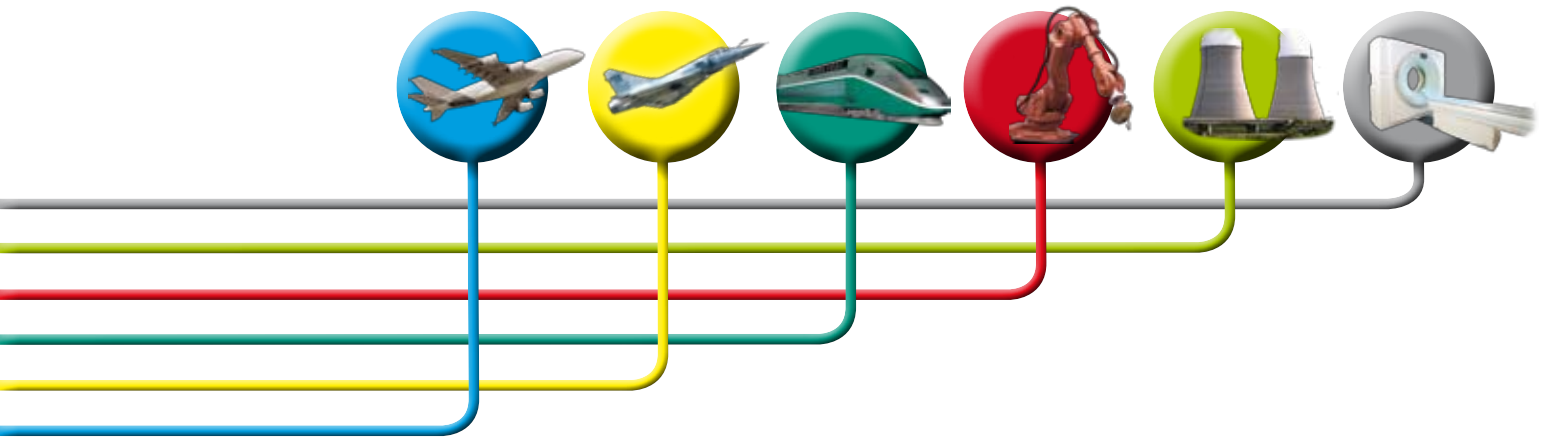

Accessoires

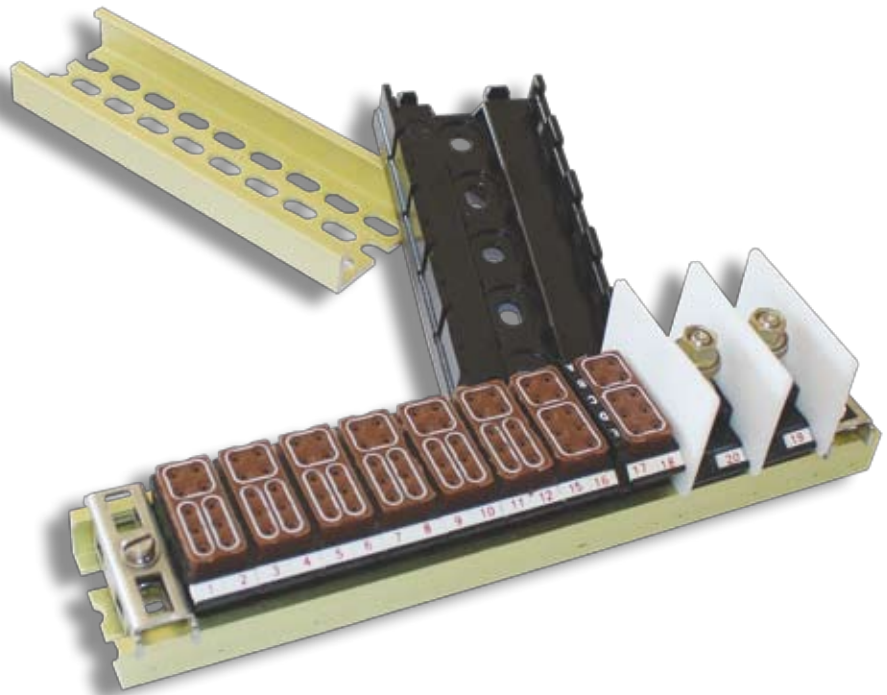

Accessories

Edition 05/12

Amphenol Air LB

SYSTEMES DE CONNEXIONS ELECTRIQUES ET ELECTRONIQUES
ELECTRIC AND ELECTRONIC CONNECTION SYSTEMS

RAILS METALLIQUES METALLIC RAILS



Pour Modules 1750, 1765 & 1767PA

Ce rail est muni d'un ressort pour clipsage/extraction des modules

For 1750, 1765 & 1767PA Modules

This rail has a spring to clip on/extract modules

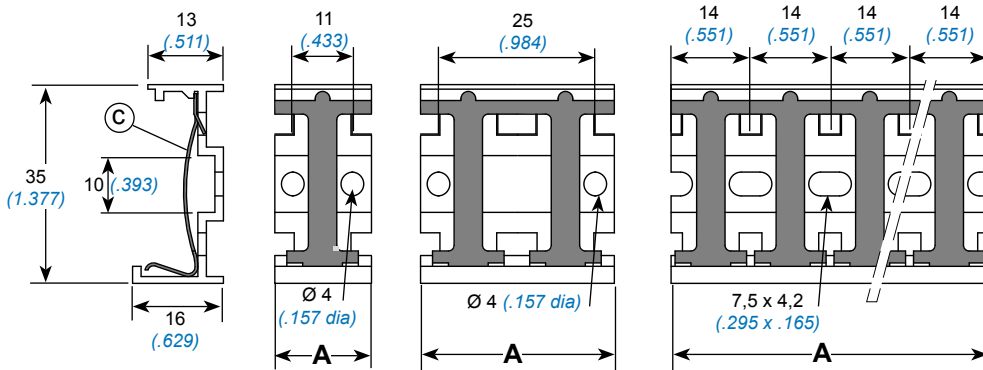

Nb de modules Nb of modules	A		Masse Weight g
	mm	inch	
1	18	.708	5
2	32	1.620	10,2
3	42	1.653	14
4	56	2.204	19
5	70	2.755	23,3
6	84	3.307	28
7	98	3.858	33
8	112	4.409	38
9	126	4.960	42

et plus, jusqu'à 1,66 mètres
and more, up to 1,66 meters

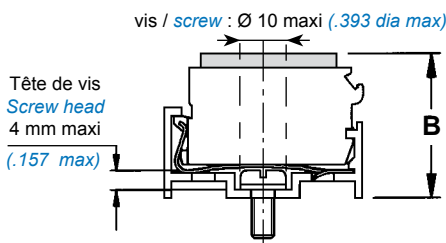

Taille modules Modules	B	
	mm	inch
22	27	1.062
20	27	1.062
20 + 12	32	1.259
12	32	1.259

Référence / PN : **001751 1** ****

Nb de modules / Nb of modules : 01 - 02 - 03 - etc...

Oxydation anodique / Anodization : **00**
Cadmium bichromaté / Cadmium bichromate plating : **07**

Spécifique pour Module de Masse 1767PA

Ce rail métallique à revêtement nickelé est strictement dédié au Module de Masse 1767PA - 18 contacts taille 20 (page 25)

Specific for 1767PA grounding module

This metallic nickel plated rail is for a strict 1767PA grounding module mounting - 18 contacts size 20 (page 25)

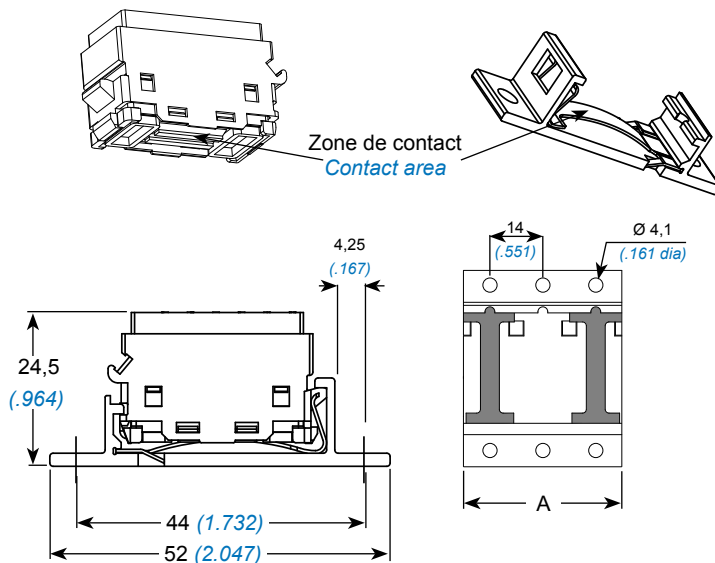

Référence / PN : **001761 PA 1** 04**

Nombre de pas de modules
Number of pitch of modules
01 - 03 - 05 - etc...

Nb de modules Nb of modules	A		** Nombre de pas number of pitches	Masse Weight g
	mm	inch		
1	11,5	.453	01	5,1
2	42	1.653	03	17,1
3	70	2.755	05	27,9
4	98	3.858	07	38,8
5	126	4.960	09	49,7

ATTENTION

- Monter le module en vis-à-vis de la fixation
- Ne pas juxtaposer ce module, laisser 1 pas de module mini
- Utiliser une tête de vis < 8,5 mm de diamètre

ATTENTION

- Insert the module facing the insert module locking device
- Do not mount modules side by side, leave at least a space for 1 module between two grounding modules
- Use a screw head < .335 in diameter

Rail Type I - Pour Modules 1100 & 1200

Rail en Alliage d'Aluminium, série 6000, anodisé bichromaté

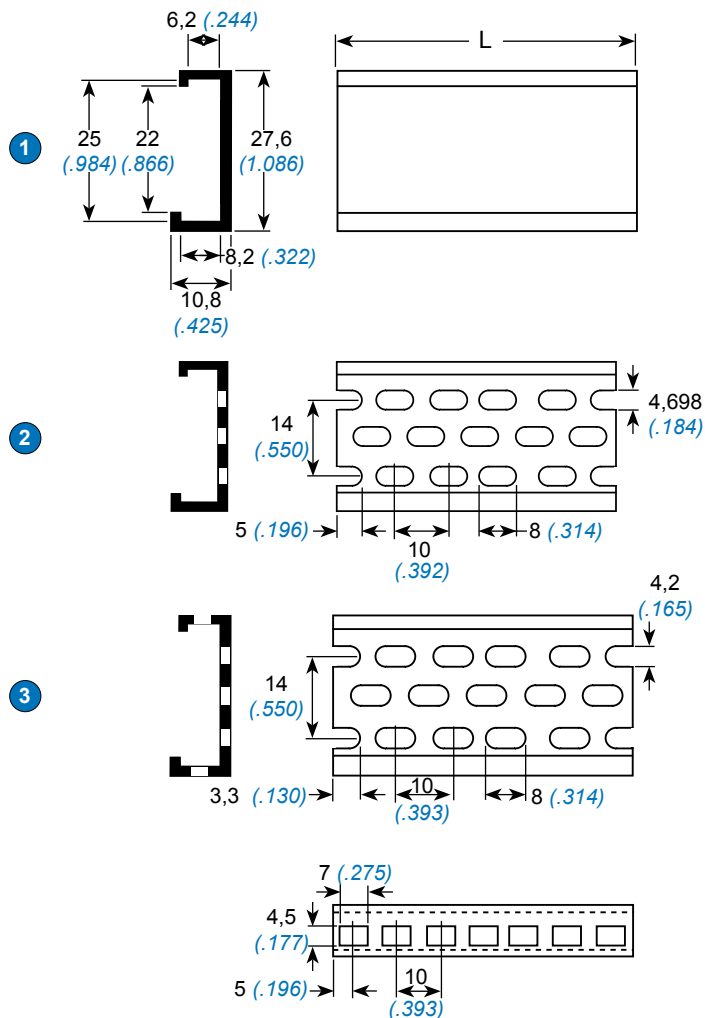

Rail type I - for 1100 & 1200 Modules

Anodized dichromated 6000 series Aluminium alloy rail



Type Type	Rep. Ident.	L		Référence Part number	Masse Weight
		mm	inch		g
1	1	1000	39.37	001101 001 10	177,5
		2000	78.74	001101 012 10	355,0
	2	1000	39.37	001101 002 10	142,0
		2000	78.74	001101 022 10	284,0
	3	1000	39.37	001101 102 10	122,0
		2000	78.74	001101 122 10	244,0

Rail Type II - Pour Modules 1100 & 1200

Rail en Alliage d'Aluminium, série 6000, anodisé bichromaté

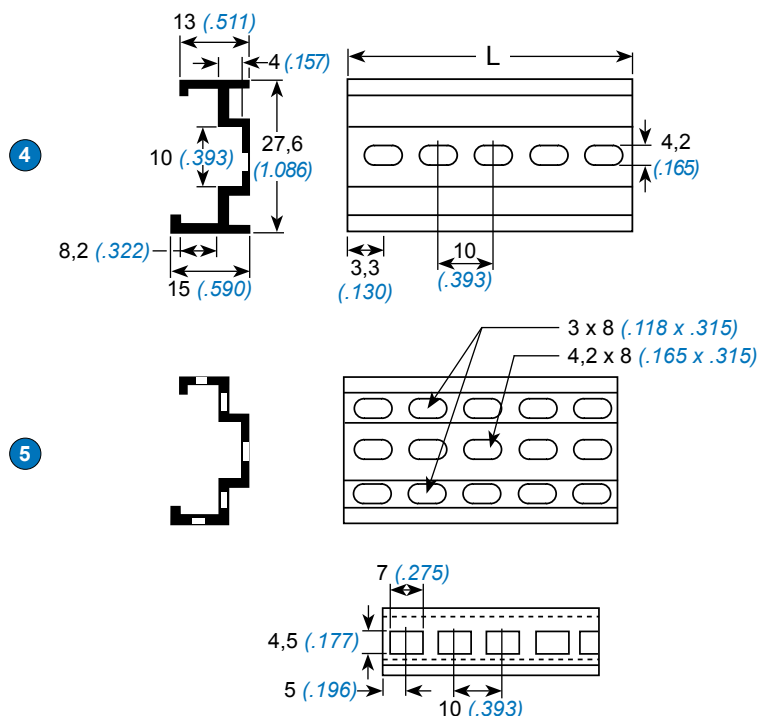

Rail type II - for 1100 & 1200 Modules

Anodized dichromated 6000 series Aluminium alloy rail

Type Type	Rep. Ident.	L		Référence Part number	Masse Weight
		mm	inch		g
2	4	1000	39.37	001101 004 10	227,0
		2000	78.74	001101 042 10	454,0
	5	1000	39.37	001101 202 10	156,0
		2000	78.74	001101 222 10	312,0

Versions 3 et 5 = Rails Allégés

3 and 5 versions = Lightweight Rails

Pour Modules MIL-T-81714 série I

Rail en Alliage d'Aluminium, anodisé noir suivant MIL-A-8625

For MIL-T-81714 series I Modules

Aluminum alloy, black anodized finish per MIL-A-8625

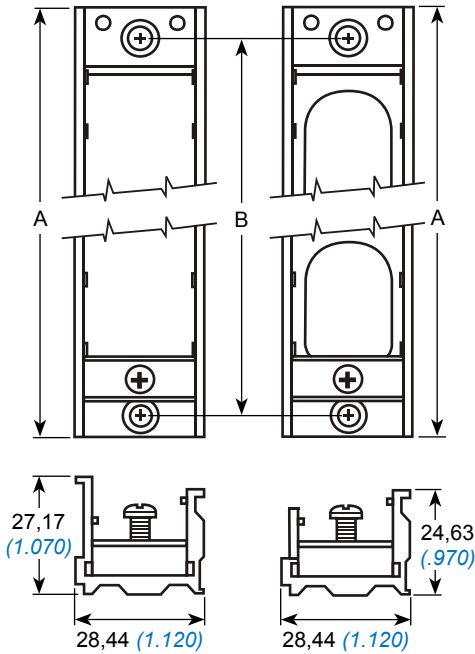

Standard		Allégé - Lightweight		Modules*	Dimensions			
MIL	Amphenol	MIL	Amphenol		A		B	
M81714/5-1	TJT701010	M81714/16-1	TJT703010	10	134,36	5.29	121,66	4.79
	TJT701002		TJT703002	2	55,11	2.17	42,41	1.67
M81714/5-2	TJT701003	M81714/16-2	TJT703003	3	65,02	2.56	52,32	2.06
M81714/5-3	TJT701004	M81714/16-3	TJT703004	4	74,93	2.95	62,23	2.45
M81714/5-4	TJT701005	M81714/16-4	TJT703005	5	84,83	3.34	72,13	2.84
M81714/5-5	TJT701006	M81714/16-5	TJT703006	6	94,74	3.73	82,04	3.23
M81714/5-6	TJT701007	M81714/16-6	TJT703007	7	104,64	4.12	91,94	3.62
M81714/5-7	TJT701008	M81714/16-7	TJT703008	8	114,55	4.51	101,85	4.01
M81714/5-8	TJT701009	M81714/16-8	TJT703009	9	124,46	4.90	111,76	4.40
M81714/5-9	TJT701011	M81714/16-9	TJT703011	11	144,27	5.68	131,57	5.18
M81714/5-10	TJT701012	M81714/16-10	TJT703012	12	154,17	6.07	141,47	5.57
M81714/5-11	TJT701013	M81714/16-11	TJT703013	13	164,08	6.46	151,38	5.96
M81714/5-12	TJT701014	M81714/16-12	TJT703014	14	173,98	6.85	161,29	6.35
M81714/5-13	TJT701015	M81714/16-13	TJT703015	15	183,89	7.24	171,19	6.74
			TJT703016	16	193,80	7.63	181,10	7.13
			TJT703017	17	203,7	8.02	191	7.52
			TJT703018	18	213,61	8.41	200,91	7.91
			TJT703019	19	223,52	8.80	210,82	8.30
			TJT703020	20	233,42	9.19	220,72	8.69

*A diviser par 3 dans le cas de modules taille 12

* To be divided by 3 for size 12 module mounting

Pour Modules MIL-T-81714 série II

Rail en Alliage d'Aluminium, anodisé noir

For MIL-T-81714 series II Modules

Aluminum alloy, black anodized

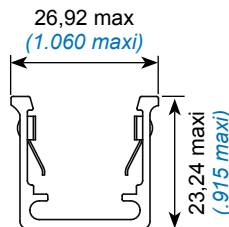
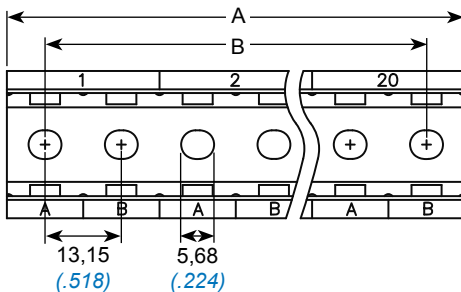

Norme Standard	Amphenol	Nb de modules* Nb of modules*	Dimensions			
			A		B	
MIL			mm	inch	mm	inch
M81714/67-2	SJT502404	2	26,31	1.036	12,15	.518
M81714/67-3	SJT503404	3	39,47	1.554	26,31	1.036
M81714/67-4	SJT504404	4	52,62	2.072	39,47	1.554
M81714/67-5	SJT505404	5	65,78	2.590	52,62	2.072
M81714/67-6	SJT506404	6	78,94	3.108	65,78	2.590
M81714/67-7	SJT507404	7	92,1	3.626	78,94	3.108
M81714/67-8	SJT508404	8	105,25	4.144	92,1	3.626
M81714/67-9	SJT509404	9	118,41	4.662	105,25	4.144
M81714/67-10	SJT510404	10	131,57	5.180	118,41	4.662
M81714/67-12	SJT512404	12	157,88	6.216	144,72	5.698
M81714/67-13	SJT513404	13	171,04	6.734	157,88	6.216
M81714/67-14	SJT514404	14	184,2	7.252	171,04	6.734
M81714/67-15	SJT515404	15	197,35	7.770	184,2	7.252
M81714/67-16	SJT516404	16	210,51	8.288	197,35	7.770
M81714/67-18	SJT518404	18	236,82	9.324	223,67	8.806
M81714/67-19	SJT519404	19	249,98	9.842	236,82	9.324
M81714/67-20	SJT520404	20	263,14	10.360	249,98	9.842
M81714/67-21	SJT521404	21	276,30	10.878	263,14	10.360
M81714/67-25	SJT525404	25	328,92	12.950	315,77	12.432
M81714/67-30	SJT530404	30	394,71	15.540	381,55	15.022
M81714/67-32	SJT532404	32	421,03	16.576	407,87	16.058
M81714/67-40	SJT540404	40	526,28	20.720	513,13	20.202

BUTEE D'ARRET END STOP



Pour Rails Métalliques Type I & II - Modules 1100&1200

For Type I & II Metallic Rails - 1100&1200 Modules

Couple de serrage : mini 0,07 mdaN - maxi 0,1 mdaN

Torque : mini 0,07 mdaN - maxi 0,1 mdaN

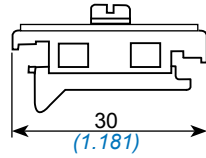

Référence / PN
001102 010 60

Masse / Weight
5,6 g

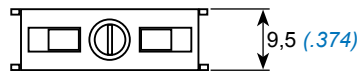

RAILS COMPOSITES COMPOSITE RAILS

Pour Modules 1750, 1765 & 1767PA

For 1750, 1765 & 1767PA Modules

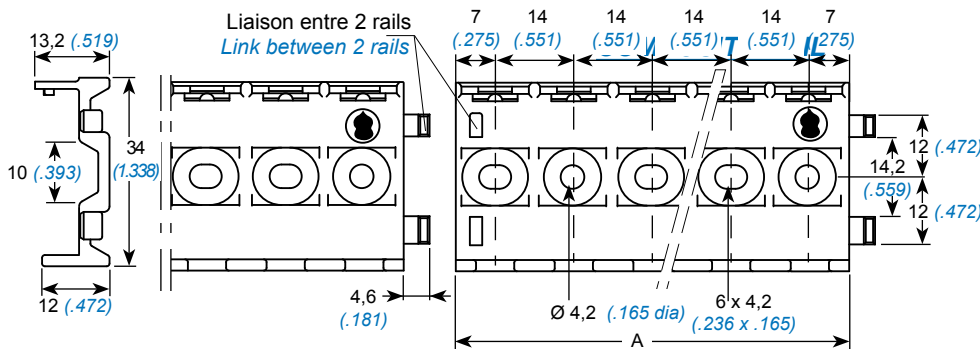

Nb de modules Nb of modules	A		Masse Weight g
	mm	inch	
05	70	2.756	9,5
10	140	5.511	19
15	210	8.267	28,5
20	280	11.023	38

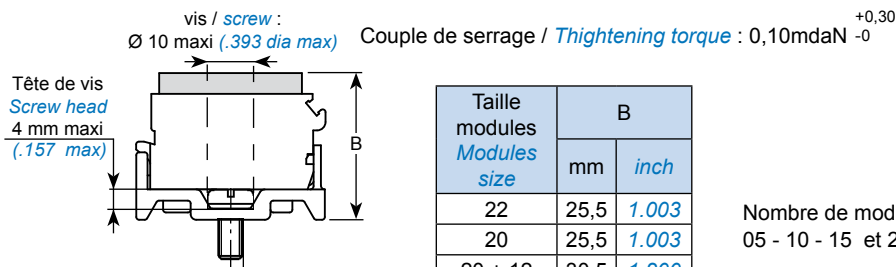

Taille modules Modules size	B	
	mm	inch
22	25,5	1.003
20	25,5	1.003
20 + 12	30,5	1.200
12	30,5	1.200

001751 6 00**

Nombre de modules / Number of modules
05 - 10 - 15 et 20 (Fractionné sur demande / Divided on request)

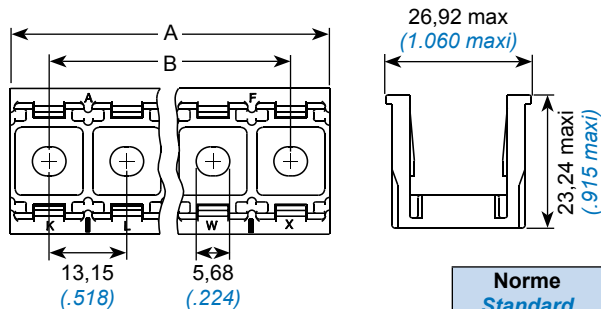

Norme Standard	MIL	Composite	Nombre de modules* Number of modules*	Dimensions			
				A		B	
				mm	inch	mm	inch
M81714/10-2	SJTC02000		2	26,31	1.036	12,15	.518
M81714/10-3	SJTC03000		3	39,47	1.554	26,31	1.036
M81714/10-4	SJTC04000		4	52,62	2.072	39,47	1.554
M81714/10-5	SJTC05000		5	65,78	2.590	52,62	2.072
M81714/10-6	SJTC06000		6	78,94	3.108	65,78	2.590
M81714/10-7	SJTC07000		7	92,1	3.626	78,94	3.108
M81714/10-8	SJTC08000		8	105,25	4.144	92,1	3.626
M81714/10-9	SJTC09000		9	118,41	4.662	105,25	4.144
M81714/10-10	SJTC10000		10	131,57	5.180	118,41	4.662
/	SJTC11000		11	144,72	5.698	131,57	5.180
M81714/10-12	SJTC12000		12	157,88	6.216	144,72	5.698
M81714/10-13	SJTC13000		13	171,04	6.734	157,88	6.216
M81714/10-14	SJTC14000		14	184,2	7.252	171,04	6.734
M81714/10-15	SJTC15000		15	197,35	7.770	184,2	7.252
M81714/10-16	SJTC16000		16	210,51	8.288	197,35	7.770
/	SJTC17000		17	223,67	8.806	210,51	8.288
M81714/10-18	SJTC18000		18	236,82	9.324	223,67	8.806
M81714/10-19	SJTC19000		19	249,98	9.842	236,82	9.324
M81714/10-20	SJTC20000		20	263,14	10.360	249,98	9.842

ETIQUETTES POUR MODULES MARKING TAGS FOR MODULES



Les étiquettes sont livrées prédécoupées en plaques, avec ou sans impression rouge sur fond blanc.

Elles sont disponibles en 2 matières :

- P.V.C. : tenue en température de -40°C à +80°C
- P.T.F.E. : tenue en température de -40°C à +200°C

Module identifications are supplied in precut blank sheets or printed red on white.

They are available in two materials :

- P.V.C. : climatic resistance from -40°C to +80°C
- P.T.F.E. : climatic resistance from -40°C to +200°C

Pour Modules 1750, 1765 & 1767PA

For 1750, 1765 & 1767PA Modules

PLANCHE DE 720 REPERES / SHEET OF 720 IDENTIFICATIONS

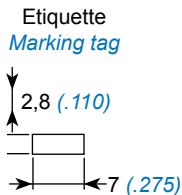

Amphenol Air LB																			
1	2	3	4	5	6	7	8	9	10	1	2	3	4	5	6	7	8	9	10
1	2	3	4	5	6	7	8	9	10	1	2	3	4	5	6	7	8	9	10
1	2	3	4	5	6	7	8	9	10	1	2	3	4	5	6	7	8	9	10
1	2	3	4	5	6	7	8	9	10	1	2	3	4	5	6	7	8	9	10
1	2	3	4	5	6	7	8	9	10	1	2	3	4	5	6	7	8	9	10
1	2	3	4	5	6	7	8	9	10	1	2	3	4	5	6	7	8	9	10
1	2	3	4	5	6	7	8	9	10	1	2	3	4	5	6	7	8	9	10

PLANCHE / SHEET		REFERENCE / PN	
Série disponible Available series	Nbre de repères Number of idents	P.V.C	P.T.F.E.
720 vierge/ blank	720	001752 100 98	001752 500 98
1 à 10	36	001752 600 02	001752 004 21
11 à 20	36	001752 700 02	001752 004 22
21 à 60	9	001752 600 41	001752 600 03
61 à 100	9	001752 700 42	001752 700 03
TB	360	001752 005 17	001752 005 25

Exemples détaillés par planche / Detailed example per sheet :

→ 36 n°1, 36 n°2, 36 n°3, jusqu'au n°10 (up to n°10)

→ 9 n°21, 9 n°22, 9 n°23, jusqu'au n°60 (up to n°60)

Autres impressions, merci de nous consulter.

For other prints, please consult us.

PLANCHE / SHEET		REFERENCE / PN	
Série disponible <i>Available series</i>	Nbre de repères <i>Number of idents</i>	P.V.C.	P.T.F.E.
vierge	600	130382 100 98	130382 500 98
1 à/to 5	120	130382 002 17	130382 002 25
6 à/to 10	120	130382 003 17	130382 003 25
11 à/to 15	120	130382 004 17	130382 004 25
16 à/to 20	120	130382 005 17	130382 005 25
21 à/to 25	120	130382 026 17	130382 026 25
26 à/to 30	120	130382 043 17	130382 043 25
31 à/to 40	60	130382 007 17	130382 007 25
41 à/to 50	60	130382 008 17	130382 008 25
51 à/to 70	30	130382 009 17	130382 009 25
71 à/to 100	20	130382 010 17	130382 010 25

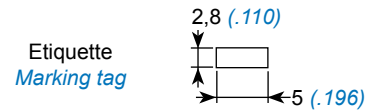

Exemples détaillés par planche / *Detailed example per sheet* :

- 120 n°11, 120 n°12, 120 n°13, jusqu'au n°15 (*up to n°15*)
- 60 n°31, 60 n°32, 60 n°33, jusqu'au n°40 (*up to n°40*)
- 30 n°51, 30 n°52, 30 n°53 jusqu'au n°70 (*up to n°70*)
- 20 n°71, 20 n°72, 20 n°73 jusqu'au n°100 (*up to n°100*)

Autres impressions, merci de nous consulter.

For other prints, please consult us.

REFERENTIEL PART NUMBERING TABLE



Réf / P/N AALBF	Réf / P/N M81714/..	Page
001101 001 10		98
001101 002 10		98
001101 004 10		98
001101 012 10		98
001101 022 10		98
001101 042 10		98
001101 102 10		98
001101 122 10		98
001101 202 10		98
001101 222 10		98
001102 010 60		100
001751 1** 00		97
001751 1** 07		97
001751 6** 00		100
001752 004 21		101
001752 004 22		101
001752 005 17		101
001752 005 25		101
001752 100 98		101
001752 500 98		101
001752 600 02		101
001752 600 03		101
001752 600 41		101
001752 700 02		101
001752 700 03		101
001752 700 42		101

Réf / P/N AALBF	Réf / P/N M81714/..	Page
130382 002 17		102
130382 002 25		102
130382 003 17		102
130382 003 25		102
130382 004 17		102
130382 004 25		102
130382 005 17		102
130382 005 25		102
130382 007 17		102
130382 007 25		102
130382 008 17		102
130382 008 25		102
130382 009 17		102
130382 009 25		102
130382 010 17		102
130382 010 25		102
130382 026 17		102
130382 026 25		102
130382 043 17		102
130382 043 25		102
130382 100 98		102
130382 500 98		102
SJT502404	67-2	99
SJT503404	67-3	99
SJT504404	67-4	99
SJT505404	67-5	99



Réf / P/N AALBF	Réf / P/N M81714/..	Page
SJT506404	67-6	99
SJT507404	67-7	99
SJT508404	67-8	99
SJT509404	67-9	99
SJT510404	67-10	99
SJT512404	67-12	99
SJT513404	67-13	99
SJT514404	67-14	99
SJT515404	67-15	99
SJT516404	67-16	99
SJT518404	67-18	99
SJT519404	67-19	99
SJT520404	67-20	99
SJT521404	67-21	99
SJT525404	67-25	99
SJT530404	67-30	99
SJT532404	67-32	99
SJT540404	67-40	99
SJTC02000	10-2	101
SJTC03000	10-3	101
SJTC04000	10-4	101
SJTC05000	10-5	101
SJTC06000	10-6	101
SJTC07000	10-7	101
SJTC08000	10-8	101
SJTC09000	10-9	101
SJTC10000	10-10	101
SJTC11000		101
SJTC12000	10-12	101
SJTC13000	10-13	101
SJTC14000	10-14	101
SJTC15000	10-15	101
SJTC16000	10-16	101
SJTC17000		101
SJTC18000	10-18	101
SJTC19000	10-19	101
SJTC20000	10-20	101
TJT701002		99

Réf / P/N AALBF	Réf / P/N M81714/..	Page
TJT701003	5-2	99
TJT701004	5-3	99
TJT701005	5-4	99
TJT701006	5-5	99
TJT701007	5-6	99
TJT701008	5-7	99
TJT701009	5-8	99
TJT701010	5-1	99
TJT701011	5-9	99
TJT701012	5-10	99
TJT701013	5-11	99
TJT701014	5-12	99
TJT701015	5-13	99
TJT703002		99
TJT703003	16-2	99
TJT703004	16-3	99
TJT703005	16-4	99
TJT703006	16-5	99
TJT703007	16-6	99
TJT703008	16-7	99
TJT703009	16-8	99
TJT703010	16-1	99
TJT703011	16-9	99
TJT703012	16-10	99
TJT703013	16-11	99
TJT703014	16-12	99
TJT703015	16-13	99
TJT703016		99
TJT703017		99
TJT703018		99
TJT703019		99
TJT703020		99

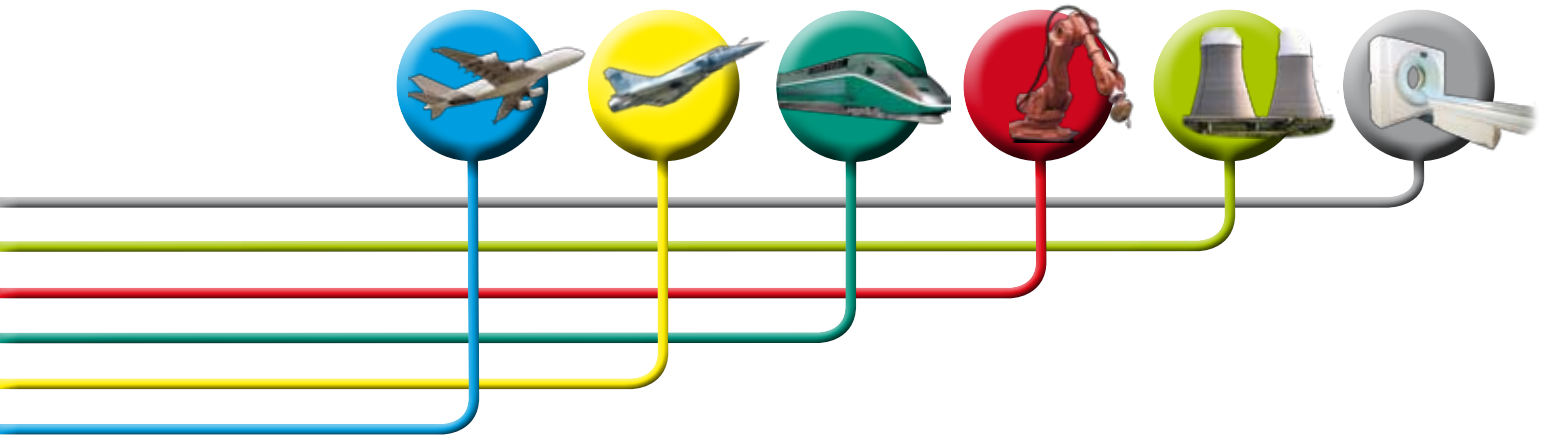

Contacts & Outillages

Contacts & Tooling

Edition 05/12

Amphenol Air LB

SYSTEMES DE CONNEXIONS ELECTRIQUES ET ELECTRONIQUES
ELECTRIC AND ELECTRONIC CONNECTION SYSTEMS

CONTACTS



MODULES & SPLICES / <i>MODULES & SPLICES</i> 1750 - 1765 - 1767 PA - 1100 - 1119 - 1177									
CONTACT				CABLE			OUTIL DE SERTISSAGE <i>CRIMPING TOOL</i>		OUTIL - <i>TOOL</i> INSERTION EXTRACTION
Taille <i>Size</i>	Genre <i>Gender</i>	Norme <i>Standard</i>	Référence <i>P/N</i>	Section mm ²	(Gauge) AWG	Ø / gaine (mm) <i>dia / seath (inch)</i>	Pince <i>Pliers</i>	Positionneur <i>Locator</i>	
22		EN3155-016M2222 NF L 53105/1 NSA 937910EA2200	001104 100 02	0,15 - 0,40	22 - 24 26	0,74 - 1,37 <i>.029 - .054</i>	M22520/2-01	AIR LB K 673	MIL I 81969/14-01 001112 100 25
20		EN3155-016M2018 NF L 53105/2 NSA 937910EA2000	001104 200 02	0,25 - 1,00	18 - 20 22 - 24	0,95 - 2,10 <i>.037 - .082</i>	M22520/1-01 M22520/2-01 M22520/7-01	M22520/1-02 M22520/2-02 M22520/7-02	MIL I 81969/14-11 NAS 1664-20 NF L 54131/20 001112 200 25
		-	001104 202 02*	0,15 - 0,40	22 - 24 26	0,95 - 2,10 <i>.037 - .082</i>	M22520/2-01	M22520/2-02	
		EN3155-016M2020 NAS 1748/1749	001104 203 02	0,25 - 0,60	20 - 22 24	0,95 - 2,10 <i>.037 - .082</i>	M22520/1-01 M22520/2-01 M22520/7-01	M22520/1-02 M22520/2-02 M22520/7-02	
		EN3155-015S2020 MIL C 39029/63-368	001704 201 02	0,25 - 0,60	20 - 22 24	0,85 - 1,73 <i>.068 - .033</i>	M22520/2-01	M22520/2-08	MIL I 81969/39-01 001112 210 25
		EN3155-015F2018	001704 202 02	0,25 - 1,00	18 - 20 22 - 24	0,85 - 1,73 <i>.068 - .033</i>	M22520/2-01	M22520/2-08	MIL I 81969/39-01 001112 211 25
16	P	EN3155-016M1616 NF L 53105/3 NSA 937910EA1600	001104 300 02	0,60 - 1,20	16 - 18 20	1,34 - 2,62 <i>0.52 - .103</i>	M22520/1-01 M22520/7-01	M22520/1-02 M22520/7-03	MIL I 81969/14-03 NAS 1664-16 NF L 54131/16 001112 300 25
		-	001104 301 02	1,00 - 2,00	14 - 16 18	1,34 - 2,62 <i>0.52 - .103</i>			
		PAN 6450 L 16/22	001104 304 02	0,25 - 0,40	22 - 24	1,34 - 2,62 <i>0.52 - .103</i>			
12		EN3155-016M1212 NF L 53105/4 NSA 937910 EA 1200	001104 400 02	2,00 - 3,00	12 - 14	2,20 - 4,01 <i>.086 - .157</i>	M22520/1-01	M22520/1-02	MIL I 81969/14-04 NAS 1664-12 NF L 54131/12 001112 400 25
			001104 403 02	0,60 - 1,20	16 - 18 20	2,20 - 4,01 <i>.086 - .157</i>			M 81969/14-04 001112 400 25
			001104 403 04	0,60 - 1,20	16 - 18 20	2,20 - 4,01 <i>.086 - .157</i>			
10			001104 620 02*	5,15 - 8,98	8 - 10	4,00 - 5,50 <i>.157 - .216</i>	M 300 BT	TP 986	MIL I 81969/14-05 001112 600 25
			001104 630 02*	5,15 - 3,00	10 - 12	2,40 - 5,20 <i>.094 - .204</i>			

* Contacts spéciaux

* *Specific contacts*

MODULES CIRCULAIRES - <i>CIRCULAR MODULES</i>									
CONTACT				CABLE			OUTIL DE SERTISSAGE <i>CRIMPING TOOL</i>		OUTIL - <i>TOOL</i> INSERTION EXTRACTION
Taille <i>Size</i>	Genre <i>Gender</i>	Norme <i>Standard</i>	Référence <i>P/N</i>	Section mm ²	(Gauge) AWG	Ø / gaine (mm) <i>dia / seath (inch)</i>	Pince <i>Pliers</i>	Positionneur <i>Locator</i>	
20	P	EN3155-016M2018 NF L 531105-2 NSA 937910EA2000	001104 200 02	0,25 - 1,00	18 - 20 22 - 24	0,95 - 2,10 <i>.037 - .082</i>	M22520/1-01 M22520/2-01 M22520/7-01	M22520/1-02 M22520/2-02 M22520/7-02	M 81969/14-11 NAS 1664-20 NF L 54131-20 001112 200 25
	S	EN3155-015S2020 MIL C 39029/63-368	001704 201 02	0,25 - 0,60	20 - 22 24	0,85 - 1,73 <i>.068 - .033</i>			M 81969/39-01 001112 210 25
	S	EN3155-015F2018	001704 202 02	0,25 - 1,00	18 - 20 22 - 24	0,85 - 1,73 <i>.068 - .033</i>	M22520/2-01	M22520/2-08	Plastique M 81969/39-01 001112 210 25 Métallique M 81969/1-02 001112 220 25

MODULES MIL-C-81714 SERIE 1



CONTACT					SERTISSAGE / <i>CRIMPING</i>		OUTIL / <i>TOOL</i>	
Taille Size	Genre Type	Référence Part Number MIL-C-39029/..	Code couleur Colour Code 1-2-3	Référence Amphenol Amphenol Part Number	Outil Tool	Positionneur Locator	Insertion Insertion	Extraction Extraction
16/22	P	1-100	Marron - Noir - Noir <i>Brown - Black - Black</i>	CNS068000	M22520/2-01	M22520/2-11	M81969/14-02	M81969/14-02
16/20		1-101	Marron - Noir - Marron <i>Brown - Black - Brown</i>	CNS060000	M22520/1-01 M22520/2-01	M22520/1-02 Red M22520/2-11	M81969/2-11	M81969/14-02
14/16		1-102	Marron - Noir - Rouge <i>Brown - Black - Red</i>	CNS037000	M22520/1-01	M22520/1-02 Blue	M81969/14-03	M81969/14-03
12/12		1-103	Marron - Noir - Orange <i>Brown - Black - Orange</i>	CNS072000	M22520/1-01	M22520/1-02 yellow	M81969/14-04	M81969/14-04
20/22D		1-507	Vert - Noir - Violet <i>Green - Black - Purple</i>	CNS022507	M22520/2-01	M22520/2-32	M81969/14-01, /1-04, /8-01, /8-02	M81969/14-01, /1-04, /8-01, /8-02

MODULES MIL-C-81714 SERIE 2

CONTACT					SERTISSAGE / <i>CRIMPING</i>		OUTIL / <i>TOOL</i>	
Taille Size	Genre Type	Référence Part Number MIL-C-39029/..	Code couleur Colour Code 1-2-3	Référence Amphenol Amphenol Part Number	Outil Tool	Positionneur Locator	Insertion Insertion	Extraction Extraction
22/22	S	22-191	Marron - Blanc - Marron <i>Brown - White - Brown</i>	CNS113900	M22520/7-01	M22520/7-11	M81969/14-01	M81969/14-01
20/20	S	22-192	Marron - Blanc - Rouge <i>Brown - White - Red</i>	CNS070900	M22520/7-01	M22520/7-12	M81969/14-10	M81969/14-10
16/16	S	22-193	Marron - Blanc - Orange <i>Brown - White - Orange</i>	CNS072900	M22520/7-01	M22520/7-13	M81969/14-03	M81969/14-03
12/12	S	22-605	Bleu - Noir - Vert <i>Blue - Black - Green</i>	CNS123900	M22520/1-01	Daniels, TH343, TP405	M81969/16-03	M81969/16-03

PROLONGATEURS SJS - *SJS SPLICES*

CONTACT					SERTISSAGE / <i>CRIMPING</i>		OUTIL / <i>TOOL</i>	
Taille Size	Genre Type	Référence Part Number MIL-C-39029/..	Code couleur Colour Code 1-2-3	Référence Amphenol Amphenol Part Number	Outil Tool	Positionneur Locator	Insertion Insertion	Extraction Extraction
20/20	P	58-363	Orange - Vert - Orange <i>Orange - Green - Orange</i>	001714 203 02	M22520/1-01	M22520/1-04 Red	M81969/14-02	M81969/14-02
20/20	S	56-351	Orange - Vert - Marron <i>Orange - Green - Brown</i>	001734 203 02	M22520/1-01	M22520/1-04 Red	M81969/14-02	M81969/14-02
16/16	P	58-364	Orange - Vert - Jaune <i>Orange - Green - Yellow</i>	001714 301 02	M22520/1-01	M22520/1-04 Blue	M81969/14-03	M81969/14-03
16/16	S	56-352	Orange - Vert - Rouge <i>Orange - Green - Red</i>	001734 301 02	M22520/1-01	M22520/1-04 Blue	M81969/14-03	M81969/14-03
12/12	P	58-365	Orange - Bleu - Vert <i>Orange - Blue - Green</i>	001714 400 02	M22520/1-01	M22520/1-04 Yellow	M81969/14-04	M81969/14-04
12/12	S	56-353	Orange - Vert - Orange <i>Orange - Green - Orange</i>	001734 400 02	M22520/1-01	M22520/1-04 Yellow	M81969/14-04	M81969/14-04

OBTURATEURS D'ETANCHEITE *SEALING PLUGS*

Ils assurent l'étanchéité dans le cas de non utilisation de cavités de jonction (conditionnés par 100 et 500)

They ensure the sealing of the junction cavities which are not used (supplied in bags of 100 or 500)

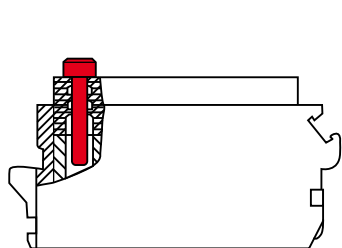

Taille Size	Couleur Colour	Référence Part Number	Masse / Weight (g) (pour / for 100 pcs)
22	Vert / <i>Green</i>	001109 190 38	4
20	Rouge / <i>Red</i>	001109 200 42	5
16	Bleu / <i>Blue</i>	001109 300 40	12
12	Jaune / <i>Yellow</i>	001109 400 41	28
10	Vert / <i>Green</i>	001109 600 00	57

OUTILS POUR CONTACTS TOOLS FOR CONTACTS



OUTILS PLASTIQUES



Insertion couleur
Insertion colour

Extraction blanc
Extraction white

PLASTIC TOOLS

Taille / Size	Insertion	Extraction	Référence / PN
22	Vert / <i>Green</i>	Blanc <i>White</i>	001112 100 25
20	Rouge / <i>Red</i>		001112 200 25
20 (pour modules 1200 for 1200 modules)	Vert / <i>Green</i>		001112 210 25
	Vert / <i>Green</i>		001112 211 25
16	Bleu / <i>Blue</i>		001112 300 25
12	Jaune / <i>Yellow</i>		001112 400 25
10	Vert / <i>Green</i>		001112 600 25

OUTILS METALLIQUES

D1

D Pinces droites
Straight pliers



Repère couleur
Colour identification

D2

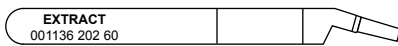

Repère blanc
White identification

METALLIC TOOLS

C Pinces coudées
Angled pliers



Repère couleur
Colour identification

C1

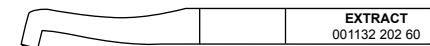

Repère blanc
White identification

C2

Taille Size	Outil Tool	Couleur Colour	D	Outil unitaire / <i>Unit tool</i>		Pochette / <i>Pocket</i>	
				Droit / <i>Straight</i>	Coudé / <i>Angled</i>	D1 + D2	C1 + C2
20	Insertion	Rouge / <i>Red</i>	1	001136 201 60	001131 201 60	001100 232 00	001100 230 00
	Extraction	Blanc / <i>White</i>	2	001136 202 60	001132 202 60		
16	Insertion	Bleu / <i>Blue</i>	1	001136 301 60	001131 301 60	001100 332 00	001100 330 00
	Extraction	Blanc / <i>White</i>	2	001136 302 60	001132 302 60		
12	Insertion	Jaune / <i>Yellow</i>	1	001136 401 60	001131 401 60	001100 432 00	001100 430 00
	Extraction	Blanc / <i>White</i>	2	001136 402 60	001132 402 60		

PRISE DE TEST

Nylon et laiton doré
Nylon and gold plated brass

Outil obligatoire pour garantir le test sans destruction.
Mandatory tool to guarantee non-destructive test.

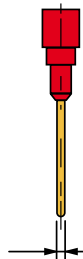

TEST PLUG

Taille Size	Ø mm	Couleur Colour	Référence Part Number
22	1,15	Vert / <i>Green</i>	001111 100 02
20	1,95	Rouge / <i>Red</i>	001111 200 02
16	2,60	Bleu / <i>Blue</i>	001111 300 02
12	3,85	Jaune / <i>Yellow</i>	001111 400 02

OUTILS POUR MODULES TOOLS FOR MODULES



OUTIL DE DECLIPSAGE DE VERROUILLAGE

Outil facultatif pour déclipser le système de verrouillage des modules 1767 PA



UNCLIPPING LOCKING-SYSTEM TOOL

Optional tool to unclip the locking-system of 1767 PA modules

Couleur / Colour	Référence / PN
Bleu / Blue	001767 PA 702 02

OUTIL HEXAGONAL pour MODULES CIRCULAIRES

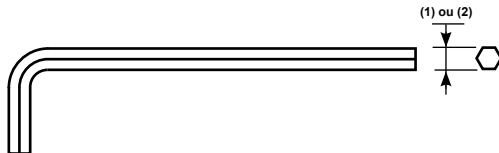

HEXAGONAL TOOL for CIRCULAR MODULES

Designation Outil / Tool description		Référence / PN
(1) Métrique Metric	4 mm sur plats .157 inch across flats	002014 000 61
(2) 5-32 inches	3,97 mm sur plats .156 inch across flats	002015 000 61

OUTIL D'EXTRACTION pour MODULES MIL série I et II

TOOL for I and II MIL MODULES series

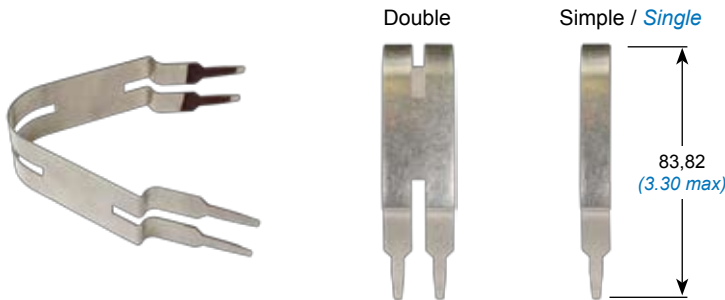

Description	Réf / PN MIL	Réf / PN Amphenol
Simple Single	M81714/69-01	CNA051300
Double	M81714/69-02	CNA052300

REFERENTIEL PART NUMBERING TABLE

Réf / P/N AALBF	Page
001100 230 00	107
001100 232 00	107
001100 330 00	107
001100 332 00	107
001100 430 00	107
001100 432 00	107
001104 100 02	105
001104 200 02	105
001104 201 02	105
001104 202 02	105
001104 203 02	105
001104 300 02	105
001104 301 02	105
001104 304 02	105
001104 400 02	105
001104 403 02	105
001104 403 04	105
001104 620 02	105

Réf / P/N AALBF	Page
001104 630 02	105
001109 190 38	106
001109 200 42	106
001109 300 40	106
001109 400 41	106
001109 600 00	106
001111 100 02	107
001111 200 02	107
001111 300 02	107
001111 400 02	107
001112 100 25	105-107
001112 200 25	105-107
001112 210 25	105
001112 220 25	105
001112 300 25	105-107
001112 400 25	105-107
001112 600 25	105-107
001131 201 60	107

Réf / P/N AALBF	Page
001131 301 60	107
001131 401 60	107
001132 202 60	107
001132 302 60	107
001132 402 60	107
001136 201 60	107
001136 202 60	107
001136 301 60	107
001136 302 60	107
001136 401 60	107
001136 402 60	107
001704 201 02	105
001704 202 02	105
001704 301 02	106
001714 203 02	106
001714 400 02	106
001734 203 02	106
001734 301 02	106

Réf / P/N AALBF	Page
001734 400 02	106
001767 PA 702 02	108
002014 000 61	108
002015 000 61	108
CNA051300	108
CNA052300	108
CNS022507	106
CNS037000	106
CNS060000	106
CNS068000	106
CNS070900	106
CNS070900	106
CNS072000	106
CNS072900	106
CNS113900	106
CNS123900	106

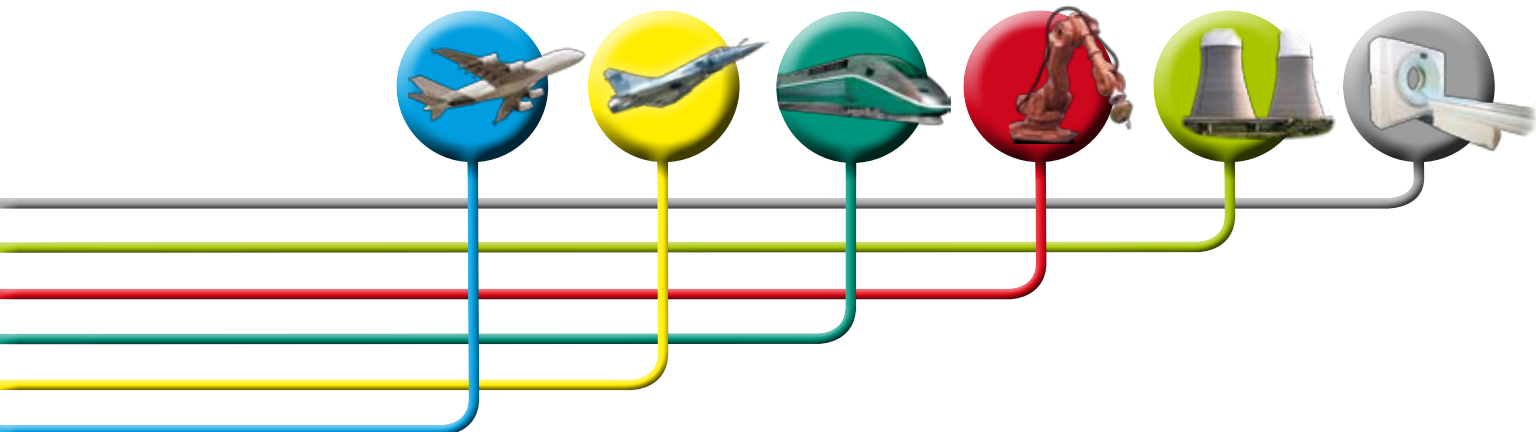

Procédures



Instructions

Edition 05/12

Amphenol Air LB

SYSTEMES DE CONNEXIONS ELECTRIQUES ET ELECTRONIQUES
ELECTRIC AND ELECTRONIC CONNECTION SYSTEMS

PROCEDURE DE CABLAGE DES CONTACTS ELECTRIQUES

WIRING INSTRUCTIONS FOR ELECTRICAL CONTACTS



Les outils de mise en oeuvre ont un rôle prépondérant dans la phase de câblage. Il est impératif qu'ils soient en excellent état. Un outil ébréché, mal réglé, nuira à la qualité ainsi qu'aux caractéristiques des produits Amphenol Air LB.

L'insertion et l'extraction des contacts s'effectuent avec des outils plastiques ou métalliques.

Wiring tools are very important. It is mandatory that they are in good condition. A chipped or badly adjusted tool will affect the quality as well as the characteristics of Amphenol Air LB products. Insertion and extraction of contacts are done with plastic or metallic tools.

SERTISSAGE

- ① Les câbles doivent être dénudés au moyen d'un outil approprié pour éviter de blesser l'âme et la gaine isolante
Dénuder le câble sur une longueur correspondant à la cote de perçage du fût de contact
- ② Le sertissage des contacts sur le câble s'effectue avec un outil de sertissage complété d'un positionneur réglé pour la taille du contact. L'outil doit être conforme à la norme MIL C 22520

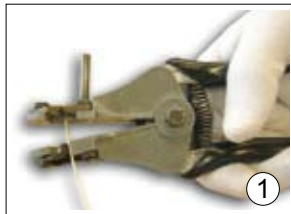

- ③ En fonction du jeu entre le diamètre de l'âme du câble et le diamètre du fût du contact, deux possibilités se présentent :
 - 1 - jeu important : mettre le contact dans les mors de l'outil, le fût étant placé vers l'opérateur, insérer le câble dénudé dans le fût du contact
 - 2 - jeu faible : placer le câble dans le fût du contact et insérer l'ensemble dans les mors de l'outil
- ④ La pince ne libérera le contact que lorsque le cycle de sertissage complet aura été effectué
 - ⓐ - Le câble doit apparaître dans le trou de regard du contact, il indique que le câble est correctement présenté au sertissage

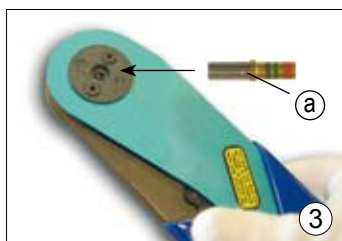

CRIMPING

- ① The cables must be stripped with a suitable tool to avoid damaging the core and the insulating sheath.
Strip the cable over a length corresponding to the drilling dimension of the cup
- ② Contacts crimping on the cable is done with a crimping tool completed with a locator corresponding to the contact size. The tool must comply with MIL C 22520 standard

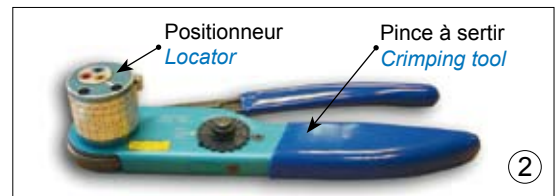

- ③ According to the space between the cable diameter and the cup diameter, one of two ways of crimping must be chosen :
 - 1 - important space : place the contact in the jaws of the tool with the cup toward the operator. Insert the stripped cable in the contact cup
 - 2 - low space : place the cable in the contact cup and insert the group in the jaws of the tool
- ④ The tool will not release the contact until the crimping process is fully completed
 - ⓐ - The cable must be visible through the peep hole thus ensuring that it is correctly crimped



INSERTION DU CONTACT

L'insertion des contacts s'effectue avec l'outil côté COULEUR qui correspond à la taille des contacts

- ① Tenir l'outil et insérer le câble dans la gorge longitudinale de l'outil
- ② Tirer le fil vers l'arrière à travers l'outil jusqu'à ce que l'extrémité de l'outil repose sur l'épaulement de la collerette du contact

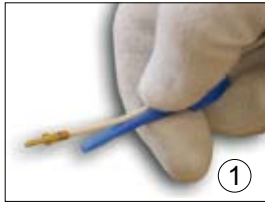

- ③ Présenter le contact dans la cavité choisie pour le raccordement
- ④ Pousser lentement le contact dans la cavité du module à l'aide de l'outil. Une butée franche sera rencontrée lorsque le contact aura pris sa place dans la cavité
- ⑤ Relâcher le câble et retirer l'outil. Effectuer une légère traction sur le câble pour être sûr que le contact est correctement verrouillé



EXTRACTION DU CONTACT

L'extraction des contacts s'effectue avec l'outil côté BLANC qui correspond à la taille des contacts.

- ① Placer le câble du contact à démonter dans la gorge longitudinale de l'outil
- ② Glisser lentement l'outil le long du câble dans la cavité jusqu'à ce qu'il rencontre une butée mécanique. A cet instant, les clips de rétention du contact se trouvent déverrouillés
- ③ Comprimer le câble du contact à démonter contre les stries de l'outil et tirer simultanément, sans tourner, le câble et l'outil hors de la cavité du module



CONTACT INSERTION

The contact insertion is made with the tool COLOUR side, the tool depending on the contact size



- ① Hold the tool and insert the cable into the longitudinal groove
- ② Pull the cable to the rear of the tool until the end of the tool is in contact with the contact flange

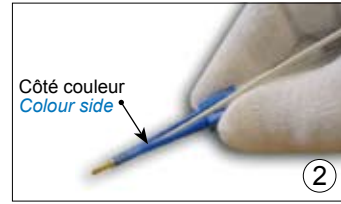

- ③ Place the contact in the cavity of the module
- ④ With the tool, slowly push the contact in the cavity. You will feel a clear stop once the contact is in position in the cavity
- ⑤ Release the cable and pull out the tool. Proceed to a gentle pull on the cable to ensure that the contact is properly locked in

CONTACT EXTRACTION

The contact extraction is made with the tool WHITE side, the tool depending on the contact size.

- ① Put the contact cable to be extracted in the longitudinal groove of the tool.
- ② Gently slide the tool down along the cable in the cavity until a mechanical stop is reached. At this point, the contact retention clip is unlocked.
- ③ Press the cable to be extracted against the grooves of the tool and pull straight out. The contact is extracted

MODULES 1767PA - PROCEDURE DE CABLAGE

1767PA MODULES - WIRING INSTRUCTIONS



Inutile d'effectuer une légère traction sur le câble pour s'assurer que le contact est correctement verrouillé car le Module 1767PA est conçu avec un dispositif de verrouillage auditif, sensitif et visuel sécurisant la conformité du câblage

Don't pull on the cable to ensure that the contact is properly locked in. 1767PA modules are equipped with a system for locking contacts security

LE MODULE SE VERRUILLE
MODULE IS LOCKING

+

TEST DE CONTINUITÉ ELECTRIQUE CORRECT
ELECTRICAL TEST OK

=

CONTACTS BIEN MONTES
CONTACTS PROPERLY LOCKED

INSERTION DES CONTACTS **(module 1767 PA déverrouillé)**

L'insertion des contacts s'effectue avec l'outil côté COULEUR qui correspond à la taille des contacts et uniquement sur module en position déverrouillée : repères blancs du module visibles



CONTACT INSERTION **(1767 PA being unlocked)**

The contact insertion is made with the tool COLOUR side according to the contact sizes and only on unlocked modules : white markers of modules appearing

- ① Tenir l'outil et insérer le câble dans la gorge longitudinale de l'outil
- ② Tirer le fil vers l'arrière à travers l'outil jusqu'à ce que l'extrémité de l'outil repose sur l'épaulement de la collerette du contact
- ③ Présenter le contact dans la cavité choisie du module (position déverrouillée), sans exercer de pression sur le fond amovible du boîtier

- ① *Hold the tool and insert the cable into the longitudinal groove*
- ② *Pull the cable to the rear of the tool until the end of the tool is resting on the contact flange*
- ③ *Take the unlocked module by the shell, and present the contact in the chosen cavity, without pressing too much on the sliding bottom*

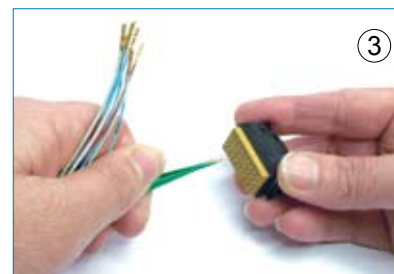
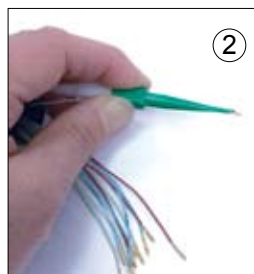
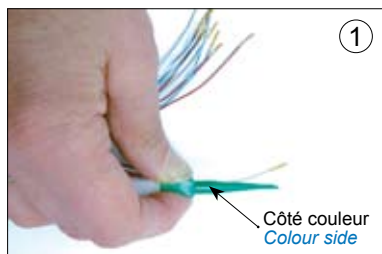

- ④ Pousser lentement le contact dans la cavité du module à l'aide de l'outil pour passer les barrières d'étanchéité, puis les clips de rétention. Une butée franche sera rencontrée lorsque le contact aura pris sa position maximum dans la zone de connexion
- ⑤ Relâcher le câble et retirer l'outil. Il n'est pas nécessaire d'effectuer une légère traction sur le câble pour s'assurer que le contact est correctement verrouillé

- ④ *Gently push the contact in the module cavity thanks to the tool to go through the sealing barriers first, then through the retention clips. An end stop will be felt once the contact is in place in its connection area*
- ⑤ *Release the cable and pull off the tool. No traction is needed to check that the contact is locked*

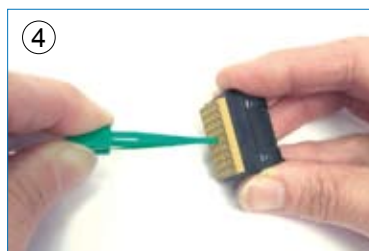

VERROUILLAGE DU MODULE 1767 PA

Pousser le fond amovible du module en butée afin d'assurer la mise en pression du joint d'étanchéité intérieur. Un double "clac" de contrôle se fait alors entendre

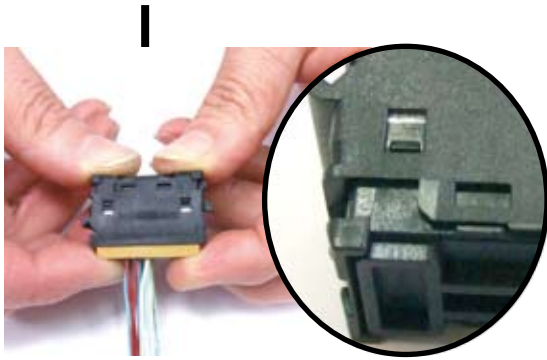

Si en début de course de verrouillage, l'effort de mise en oeuvre augmente considérablement sans translation du fond du module, cela signifie qu'un ou plusieurs contacts se situent hors de la zone de connexion. Dans ce cas, stopper la phase de verrouillage pour ne pas casser les clips de rétention et rechercher les contacts qui ne sont pas correctement insérés suivant la phase d'insertion des contacts

1767 PA MODULE LOCKING

Press on the bottom part of the module until a Double Click is heard this ensures the locking of the contacts as well as the compression of the internal sealing joint

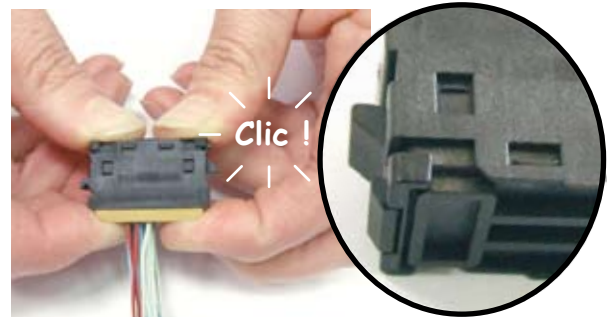

If during locking, the pressure exerted to clip the locking system is too high while the bottom does not slide, it means that one or more contact are not in their connection area. Just stop the procedure not to break the retention clips, and find the badly inserted contacts to re-insert them correctly according to the insertion procedure

DEVERROUILLAGE DU MODULE 1767 PA

- ① Maintenir le boîtier par le grommet et les flancs. Ecarter légèrement les flancs de déclipsage du verrouillage uniquement pour libérer les clips de mise en pression d'étanchéité (effet sonore de déclipsage)
- ① Possibilité d'utiliser un outil de déclipsage : placer les deux ergots de l'outil entre les deux flancs de déclipsage du déverrouillage et les quatre clips de mise en pression. Glisser lentement l'outil le long des parois jusqu'à ce qu'il rencontre une butée mécanique. A cet instant, les clips de mise en pression se trouvent déverrouillés. Retirer l'outil du fond du module
- ② Maintenir le boîtier par le porte-étiquette et le guide

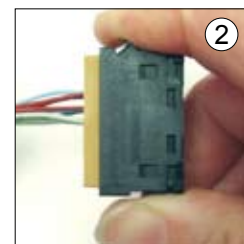
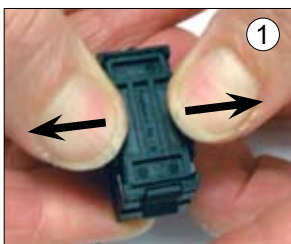

- ③ Pousser le faisceau de câbles jusqu'en butée de course de déverrouillage, les repères blancs de déverrouillage deviendront visibles
- ③ Dans le cas d'un module non câblé : Tirer le fond du module de 2 mm jusqu'aux butées de course de déverrouillage en l'extrayant par deux des quatre coins inférieurs en diagonale (les repères blancs de déverrouillage deviendront visibles)

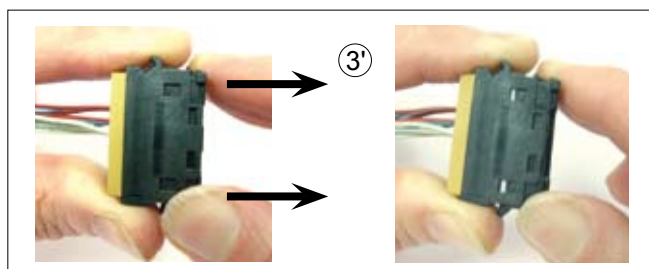
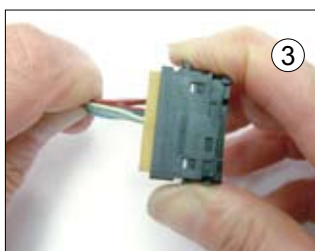

MODULE UNLOCKING

- ① Hold the shell by the clipping-sides and the grommet. Open gently the clipping-sides to free the sealing retention clips (unclipping sound)
- ① If using an unclipping tool : place the two legs of the tool between the two clipping-sides and the four retention clips. Gently slide the tool far as it stops. At this moment, the retention clips are unlocked. Pull-off the tool from the module
- ② Hold the shell by the label-holder and the guide module

- ③ Push the cables as far as the unlocking end stops, the white markers will appear
- ③ If the module is not cabled : Pull off the sliding bottom of the modules, as far as the unlocking end stops, by taking it with 2 of the 4 bottom corners transversaly (white markers will appear)

EXTRACTION DES CONTACTS **(module 1767 PA déverrouillé)**

L'extraction des contacts s'effectue avec l'outil côté BLANC qui correspond à la taille des contacts

- ① Placer le câble du contact à démonter dans la gorge longitudinale de l'outil
- ② Glisser lentement l'outil le long du câble dans la cavité jusqu'à ce qu'il rencontre une butée mécanique. A cet instant, les clips de rétention du contact se trouvent déverrouillés
- ③ Comprimer le câble du contact à démonter contre les stries de l'outil et tirer simultanément sur le câble et l'outil hors de la cavité de raccordement

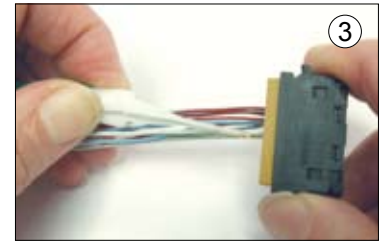
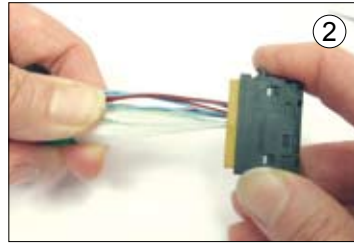
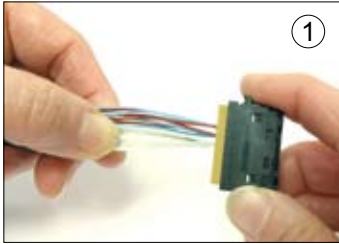

CONTACTS EXTRACTION **(1767 PA being unlocked)**

Contact extraction is made with the WHITE side of the tool, corresponding to the contact size

- ① Place the cable to be extracted in the longitudinal groove of the tool
- ② Slide gently the tool along the cable in the cavity, until it stops. At this moment, the contact retention clips are freed
- ③ Press the cable against the tool and pull both the cable and the tool out of the cavity

MODULES 1767PA

MONTAGE/DEMONTAGE SUR RAIL METALLIQUE

1767PA MODULES

MOUNTING/UNMOUNTING ON METALLIC RAIL



① **MONTAGE** : Engager le bossage (a) du module face à l'empreinte (a1) du rail. Exercer une pression sur le module jusqu'au déclic de verrouillage provoqué par le ressort (c) du support

② **DEMONTAGE** : Côté repère module, positionner une lame de tournevis (5 mm maxi) entre la partie saillante du support et le module, puis exercer une légère pression jusqu'au désencliquetage du module

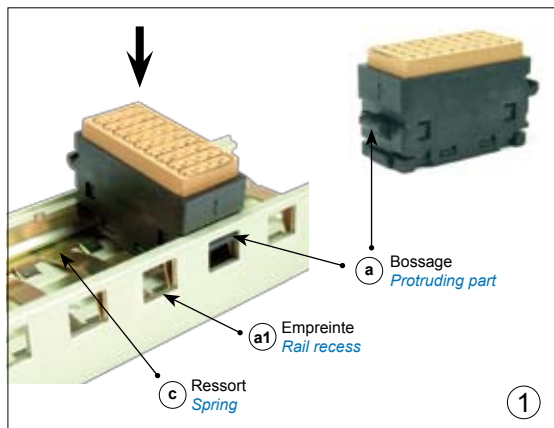

① **MOUNTING** : Insert the protruding part (a) of the module, facing the rail recess (a1). Exert sufficient pressure on the module to click the locking spring (c) mechanism

② **UNMOUNTING** : Place the screwdriver blade (.197 inch maxi) between the protruding part of the support and the module on the identification side, then exert a light pressure until the release of the module

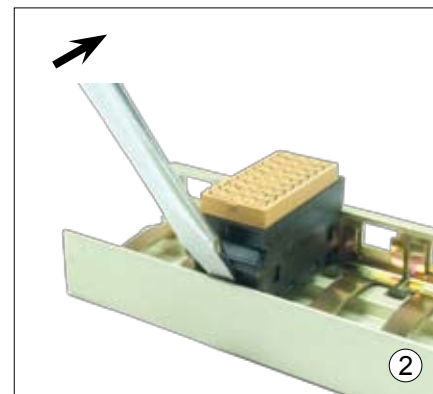

MODULES 1767PA

MONTAGE/DEMONTAGE SUR RAIL COMPOSITE

1767PA MODULES

MOUNTING/UNMOUNTING ON COMPOSITE RAIL



① **MONTAGE** : Engager les bossages (a) et (b) du module face aux empreintes (a1) et (b1) du rail. Face au guide (c) exercer une pression sur le module jusqu'au déclic de verrouillage

② **DEMONTAGE** : Côté repère module, positionner une lame de tournevis (5 mm maxi) entre la languette du rail (f) et le module, puis exercer une légère pression jusqu'au désencliquetage du module

① **MOUNTING** : Insert the protruding parts (a) and (b) of the module, facing the rail recess (a1) and (b1). Face the guide (c) and exert pressure on the module until the lock is triggered

② **UNMOUNTING** : On the module identification side, place a screwdriver blade (.197 inch maxi) between the rail tong (f) and the module, then exert a light pressure until the release of the module

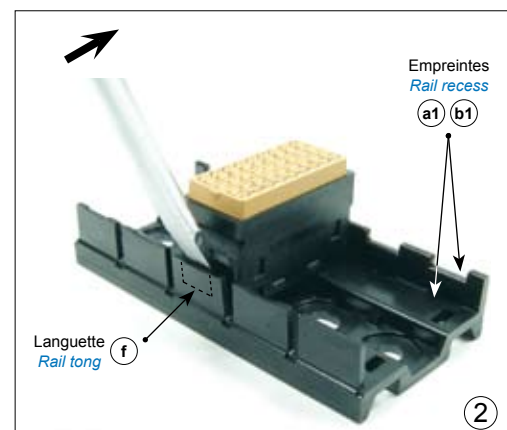
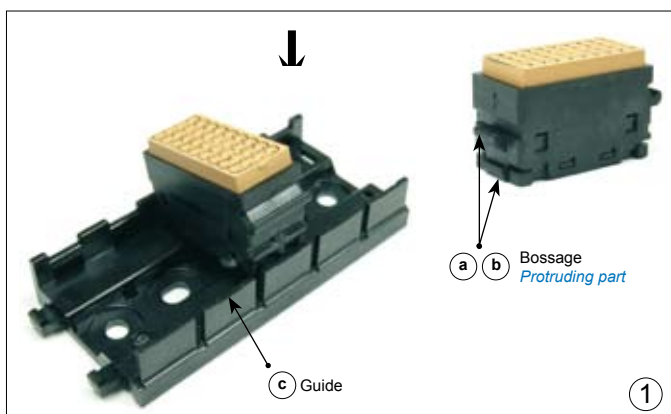

MODULES 1100 & 1200

MONTAGE/DEMONTAGE SUR RAIL METALLIQUE

1100 & 1200 MODULES

MOUNTING/UNMOUNTING ON METALLIC RAIL



MONTAGE

- ① Fixer la butée (b1)
- ② Par rotation, placer les modules dans le rail (a)
- ③ Fixer la butée (b2)

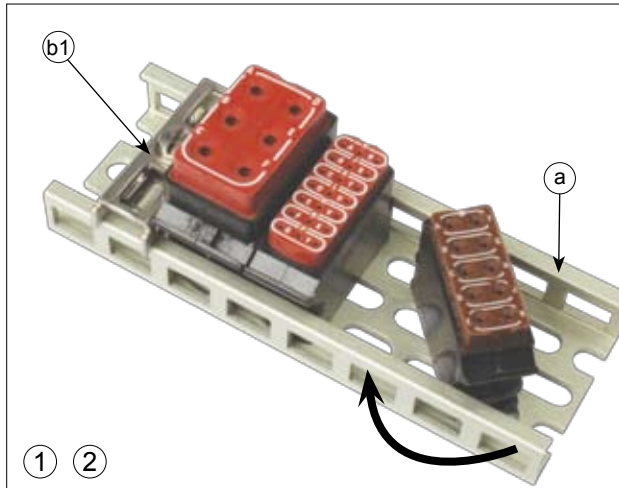

MOUNTING

- ① Set end stop (b1)
- ② Rotate module into the rail (a)
- ③ Set end stop (b2)

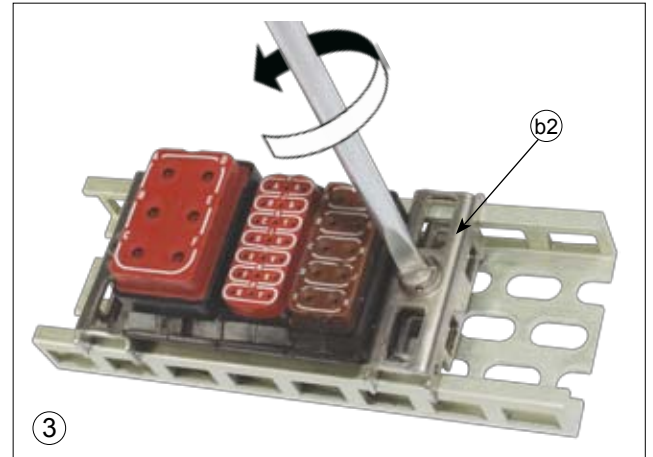

DEMONTAGE

- ① A l'aide d'un tournevis, desserrer la vis (b3) et déplacer la butée d'extrémité (b2) de 17mm minimum
- ② Tourner le module d'un quart de tour jusqu'à dégager le rebord (c) de chaque côté
- ③ Extraire la module

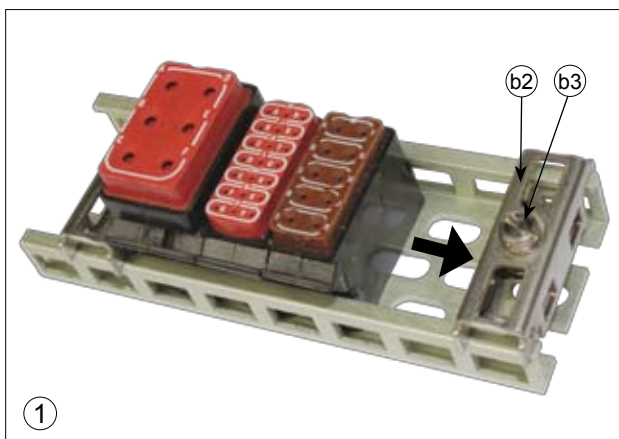

UNMOUNTING

- ① With a screwdriver, loosen end stop screw (b3)
- ② Move end stop (b2) a minimum of .669 inch
- ③ Turn module a quarter of a turn until the flange on each side (c) is free
- ④ Extract the module

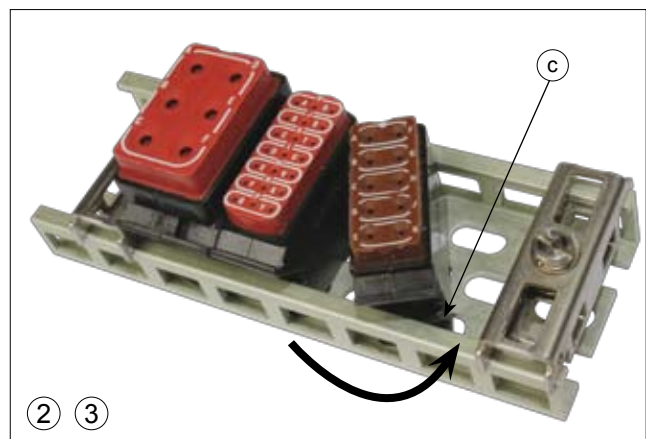

REFERENTIEL GENERAL

GENERAL PART NUMBERING TABLE



Réf /P/N AALBF	Réf /P/N EN 3708-	Réf /P/N OTAN	Réf / P/N M81714/..	Réf /P/N NSA	Page
3108 8002 502					72
3108 8003 502					72
000570 304 07					42
000842 030 60					13
000842 050 60		5310143250111			13-39
000842 080 60					39
000862 138 60					39
000863 190 99		5310144438139			39
001100 230 00					107
001100 232 00					107
001100 264 02					35
001100 267 02					35
001100 271 02					35
001100 272 02					35
001100 279 81					85
001100 280 81					85
001100 281 81					84
001100 330 00					107
001100 332 00					107
001100 388 81					84
001100 430 00					107
001100 432 00					107
001101 001 10	005A1000	9520143730917			41-42-98
001101 002 10					98
001101 004 10					98
001101 012 10					98
001101 022 10					98
001101 042 10					98
001101 102 10					98
001101 122 10					98
001101 202 10					98
001101 222 10					98
001102 004 60		5940143460630		NSA937901SC	39-40
001102 007 60		5940143460631		NSA937901SD	39-40
001102 010 60					41-42-100
001104 100 02					76
001104 100 02					105
001104 200 02					71-76
001104 200 02					105
001104 201 02					105
001104 202 02					105
001104 203 02					105
001104 220 02					76
001104 300 02					105
001104 301 02					105
001104 304 02					105
001104 400 02					105
001104 403 02					105
001104 403 04					105
001104 620 02					105
001104 630 02					105
001107 200 60		5940143130033			36
001107 200 61		5940143008317		NSA93791520	36
001107 300 60		5940140417062			36
001107 300 61		5940143883538		NSA93791516	36
001109 190 38					106
001109 200 42					106
001109 300 40					106
001109 400 41					106



Réf /P/N AALBF	Réf /P/N EN 3708-	Réf /P/N OTAN	Réf / P/N M81714/..	Réf /P/N NSA	Page
001109 600 00					106
001111 100 02					107
001111 200 02					107
001111 300 02					107
001111 400 02					107
001112 100 25					105-107
001112 200 25					105-107
001112 210 25					105
001112 220 25					105
001112 300 25					105-107
001112 400 25					105-107
001112 600 25					105-107
001115 101 02	003A01	5999144362736		NSA937901M2201	33
001115 101 02 Y					36
001115 102 02	003A02	5999144213957		NSA937901M2202	33
001115 103 02	003A03			NSA937901M2203	33
001115 104 02	003A04			NSA937901M2204	33
001115 104 02Y					36
001115 105 02	003A05			NSA937901M2205	33
001115 105 02Y					36
001115 106 02	003A06			NSA937901M2206	33
001115 150 02					35
001115 151 02					35
001115 201 02	003B01	5940143460632		NSA937901M2001	33
001115 201 02Y					36
001115 201 02Z					36
001115 202 02	003B02	5999143491790		NSA937901M2002	33
001115 202 02Y					36
001115 203 02	003B03	59401438599886		NSA937901M2003	33
001115 204 02	003B04	59991434600633		NSA937901M2004	33
001115 205 02	003B05	5999143741382		NSA937901M2005	33
001115 205 02Y					36
001115 206 02	003B06	5999143460634		NSA937901M2006	33
001115 207 02	003B07	5940143513933		NSA937901M2007	33
001115 208 02	003B08	5999143460635		NSA937901M2008	33-34
001115 209 02	003B09	5999143460636		NSA937901M2009	33
001115 209 02Y					36
001115 209 02Z					36
001115 210 02	003B10	5999143992019		NSA937901M2010	33
001115 211 02	003B11	5999143460637		NSA937901M2011	33
001115 211 02Y					36
001115 211 02Z					36
001115 301 01	003C01			NSA937901M1601	34
001115 301 02	003C02	5940143497421		NSA937901M1602	34
001115 303 02	003C03			NSA937901M1603	34
001115 304 02	003C04	5999143591486		NSA937901M1604	34
001115 305 02	003C05	5940143513932		NSA937901M1605	34
001115 306 02	003C06	5940143602055		NSA937901M1606	34
001115 308 02	003C08	5999144201076			34
001115 401 02	003D01			NSA937901M1203	34
001115 402 02	003D02	5999144362734		NSA937901M1204	34
001115 403 02	003D03			NSA937901M1205	34
001115 404 02	003D04	5999144362733		NSA937901M1206	34
001115 501 02	003C51	5940143589071		NSA937901M1202	33
001115 503 02				NSA937901M1207	33
001118 202 02				NSA937916-20	34
001118 202 02Y					36
001118 302 02				NSA937916-16	34
001118 302 02Y					36
001118 501 02					34
001119 108 02					80
001119 158 02					81
001119 168 02					81
001119 201 02					80
001119 201 30					80



Réf /P/N AALBF	Réf /P/N EN 3708-	Réf /P/N OTAN	Réf / P/N M81714/..	Réf /P/N NSA	Page
001119 202 02					80
001119 203 02					80
001119 204 02					80
001119 222 02					80
001119 223 02					80
001119 224 02					80
001119 252 02					81
001119 282 02					81
001119 301 02					80
001119 302 02					80
001119 322 02					80
001119 501 02					80
001119 503 02					80
001119 702 02					82
001119 703 02					82
001119 705 02					82
001119 711 02					82
001119 731 02					82
001119 732 02					83
001119 741 02					82
001119 745 02					82
001119 746 02					82
001119 751 02					82
001119 754 02					83
001119 755 02					83
001119 756 02					83
001119 762 02					83
001119 763 02					83
001119 764 02					83
001119 765 02					82
001119 768 02					82
001119 769 02					83
001119 773 02					83
001119 774 02					83
001119 775 02					83
001119 776 02					83
001119 777 02					83
001119 778 02					83
001119 779 02					82
001119 780 02					83
001119 782 02					83
001119 784 02					83
001119 785 02					83
001119 788 02					82
001119 790 02					82
001119 792 02					83
001119 801 02					82
001119 802 02					82
001119 810 02					82
001119 812 02					83
001119 814 02					83
001119 815 02					83
001119 816 02					83
001120 201 02					85
001120 203 02					84
001120 205 02					84
001120 205 04					84
001120 209 02					84
001120 212 02					85
001120 214 02					85
001120 215 02					84
001120 215 04					84
001120 216 02					85
001120 217 02					85
001120 223 02					84



Réf /P/N AALBF	Réf /P/N EN 3708-	Réf /P/N OTAN	Réf / P/N M81714/..	Réf /P/N NSA	Page
001120 226 02					85
001120 230 02					85
001120 304 02					84
001120 305 02					84
001120 314 02					84
001120 321 02					85
001120 324 02					85
001120 325 02					85
001120 601 02					84
001120 601 04					84
001120 603 02					84
001120 604 02					84
001120 604 04					84
001120 606 02					85
001120 610 02					84-85
001120 610 04					84
001120 612 02					85
001120 614 02					85
001120 618 02					85
001121 000 37		5970143637668		NSA937901P	39-40
001123 000 39		5970143755943		NSA937901IN	39-40
001126 000 39		5970143491815		NSA937901IS	39-40
001129 101 39					40
001129 102 39					40
001129 103 39					40
001129 104 39					40
001129 105 39					40
001129 106 39					40
001129 201 39					40
001129 202 39					40
001129 203 39					40
001129 204 39					40
001129 205 39					40
001129 206 39					40
001130 802 02					38
001130 805 02					38
001130 808 02					38
001130 809 02					38
001130 901 02					37
001130 902 02					37
001130 903 02					37
001130 904 02					37
001130 905 02					37
001130 906 02					37
001130 907 02					37
001130 908 02					37
001130 909 02					37
001130 910 02					37
001131 201 60					107
001131 301 60					107
001131 401 60					107
001132 202 60					107
001132 302 60					107
001132 402 60					107
001136 201 60					107
001136 202 60					107
001136 301 60					107
001136 302 60					107
001136 401 60					107
001136 402 60					107
001145 201 02Y					36
001145 201 02Z					36
001145 212 02Y					36
001145 212 02Z					36
001150 943 37					39



Réf /P/N AALBF	Réf /P/N EN 3708-	Réf /P/N OTAN	Réf / P/N M81714/..	Réf /P/N NSA	Page
001150 949 37		5940143460648		NSA937901B	39
001152 932 37					39
001152 935 37		5940143755944			39
001152 938 37					39
001152 943 37					39
001152 949 37					39
001174 230 00					71
001174 240 00					71
001174 250 00					71
001174 260 00					71
001177 100 00					76
001177 110 00					76
001177 220 00					76
001181 433 34		5940143256499			41
001181 533 34		5940143589073			41
001181 633 34					41
001181 635 34		5940143637220			42
001181 735 34					42
001182 000 34					41-43
001182 001 34					41-43
001182 002 34					41-43
001183 000 34		5940143637219			41-43
001184 000 34		5940143256510			41-43
001185 000 34		5940143589075			42-43
001186 000 34		5970143589075			42-43
001186 001 34					42-43
0012*5 201 02					48
0012*5 202 02					48
0012*5 203 02					48
0012*5 204 02					48
0012*5 205 02					48
0012*5 206 02					48
0012*5 207 02					48
0012*5 208 02					48
0012*5 209 02					48
0012*5 210 02					48
0012*5 211 02					48
001704 201 02					72
001704 201 02					105
001704 202 02					72
001704 202 02					105
001704 301 02					106
001714 203 02					106
001714 400 02					106
001734 203 02					106
001734 301 02					106
001734 400 02					106
001750 271 02					12
001751 1** 00					97
001751 1** 07					97
001751 6** 00					100
001752 004 21					101
001752 004 22					101
001752 005 17					101
001752 005 25					101
001752 100 98					101
001752 500 98					101
001752 600 02					101
001752 600 03					101
001752 600 41					101
001752 700 02					101
001752 700 03					101
001752 700 42					101
001755 101 02		5940144088803			9
001755 102 02		5940144088804			9



Réf /P/N AALBF	Réf /P/N EN 3708-	Réf /P/N OTAN	Réf / P/N M81714/..	Réf /P/N NSA	Page
001755 103 02		5940144088805			9
001755 104 02		5940144088806			9
001755 105 02		5940144088807			9
001755 106 02					9
001755 107 02					9
001755 201 02		5940144088825			9
001755 202 02		5940144088808			9
001755 203 02		5940144088809			9
001755 204 02		5940144088810			9
001755 205 02		5940144088811			9
001755 206 02		5940144088812			9
001755 207 02		5940144088813			9
001755 208 02					9
001755 209 02					9
001755 211 02					9
001755 212 02		5940144088814			9
001755 301 02		5940144088815			10
001755 302 02		5940144088816			10
001755 303 02		5940144088817			10
001755 304 02		5940144088818			10
001755 305 02		5940144088819			10
001755 306 02		5940144088820			10
001755 307 02					10
001755 401 02		5940144088821			10
001755 402 02		5940144088822			10
001755 403 02		5940144088823			10
001755 501 02		5940144088829			10
001755 502 02		5940144088830			10
001755 503 02		5940144088831			10
001755 504 02					10
001755 601 02					10
001758 101 02					11
001758 120 02					11
001758 201 02		5940144088834			11
001758 202 02		5940144088835			11
001758 212 02					11
001758 213 02					11
001758 220 02					11
001758 301 02					11
001758 401 02					11
001758 501 02					11
001760 933 56					13
001760 935 56		5940144088836			13
001761 000 56					13
001761 1** 39		59401440888**			13
001762 00* 04					13
001765 012 99				ASNE 0598	18
001765 016 99				ASNE 0598	18
001765 017 99				ASNE 0598	18
001765 019 99				ASNE 0598	18
001765 201 02		59401440301332		ASNE 0598	19
001765 202 02		59401440301333		ASNE 0598	19
001765 203 03				ASNE 0598	19
001765 204 02		59401440301337		ASNE 0598	18
001765 205 99				ASNE 0598	18
001765 206 02				ASNE 0598	19
001765 207 02				ASNE 0598	18
001765 901 02		5940144088844			12
001765 902 02					12
001765 903 02					12
001765 904 02					12
001765 905 02					12
001765 906 02					12
001765 907 02					12
001765 909 02					12



Réf /P/N AALBF	Réf /P/N EN 3708-	Réf /P/N OTAN	Réf / P/N M81714/..	Réf /P/N NSA	Page
001765 916 02					12
001767 PA 101 02					25
001767 PA 102 02					25
001767 PA 103 02					25
001767 PA 104 02					25
001767 PA 105 02					25
001767 PA 106 02					25
001767 PA 107 02					25
001767 PA 201 02					25
001767 PA 202 02					25
001767 PA 203 02					25
001767 PA 204 02					25
001767 PA 205 02					25
001767 PA 206 02					25
001767 PA 207 02					25
001767 PA 208 02					25
001767 PA 220 02					25
001767 PA 401 02					25
001767 PA 502 02					25
001767 PA 503 02					25
001767 PA 702 02					108
002014 000 61					71
002014 000 61					108
002015 000 61					71-72
002015 000 61					108
012439 500 20		5940143730924			42
012439 500 34					43
022357 500 20		5940142363420			41
022357 500 34					43
022358 100 98					41-42
022358 200 98		9905143540960			43
024055 005 04		6150143755945		NSA937901SH05	39-40
035127 010 02					42
122360 010 02		5940142147138			41
122375 010 02					41
122382 000 98		9905142631896			41-42
122382 001 98		9905143256604			42
130382 002 17					102
130382 002 25					102
130382 003 17					102
130382 003 25					102
130382 004 17					102
130382 004 25					102
130382 005 17					102
130382 005 25					102
130382 007 17					102
130382 007 25					102
130382 008 17					102
130382 008 25					102
130382 009 17					102
130382 009 25					102
130382 010 17					102
130382 010 25					102
130382 026 17					102
130382 026 25					102
130382 043 17					102
130382 043 25					102
130382 100 98					102
130382 500 98					102
CNA051300					108
CNA052300					108
CNS022507					106
CNS037000					106
CNS060000					106
CNS068000					106



Réf /P/N AALBF	Réf /P/N EN 3708-	Réf /P/N OTAN	Réf / P/N M81714/..	Réf /P/N NSA	Page
CNS070900					106
CNS072000					106
CNS072900					106
CNS113900					106
CNS123900					106
CNS123900					106
SJG012200					64
SJG012270			63-12F		64
SJG016100					64
SJG016170			63-16S		64
SJG016200					64
SJG016270			63-16F		64
SJG020100					64
SJG020170			63-20S		64
SJG020200					64
SJG020270			63-20F		64
SJG022100					64
SJG022170			63-22S		64
SJG022200					64
SJG022270			63-22F		64
SJM012100			60-12-01		63
SJM012200			60-12-02		63
SJM012300			60-12-03		63
SJM016100			60-16-01		63
SJM016200			60-16-02		63
SJM016300			60-16-03		63
SJM020100			60-20-01		62
SJM020200			60-20-02		62
SJM020300			60-20-03		62
SJM020400			60-20-04		62
SJM020500			60-20-06		62
SJM022100			60-22-01		62
SJM022200			60-22-02		62
SJM022400			60-22-04		62
SJM022500			60-22-05		62
SJM022600			60-22-06		62
SJM022700			60-22-10		62
SJS316700			65-16-1		90
SJS316701			65-16-2		90
SJS320700			65-20-1		90
SJS320701			65-20-2		90
SJS322701			65-22-1		90
SJS322701			65-22-2		90
SJS445000					92-95
SJS512100					91
SJS512101					91
SJS512110					91
SJS512111					91
SJS512200					91
SJS512201					91
SJS512210					91
SJS512211					91
SJS716100					91
SJS716101					91
SJS716110					91
SJS716111					91
SJS716200					91
SJS716201					91
SJS716210					91
SJS716211					91
SJS720100					91
SJS720101					91
SJS720110					91
SJS720111					91
SJS720200					91



Réf /P/N AALBF	Réf /P/N EN 3708-	Réf /P/N OTAN	Réf / P/N M81714/..	Réf /P/N NSA	Page
SJS720201					91
SJS720210					91
SJS720211					91
SJS816100					91
SJS816101					91
SJS816110					91
SJS816111					91
SJS816120					91
SJS816121					91
SJS816200					91
SJS816201					91
SJS816210					91
SJS816211					91
SJS816220					91
SJS816221					91
SJS820100					91
SJS820101					91
SJS820110					91
SJS820111					91
SJS820120					91
SJS820121					91
SJS820200					91
SJS820201					91
SJS820210					91
SJS820211					91
SJS820220					91
SJS820221					91
SJS830100					94
SJS830101					94
SJS830102					94
SJS830200					94
SJS830201					94
SJS830202					94
SJS830210					92
SJS830211					92
SJS830220					94
SJS830221					94
SJS830222					94
SJS830230					92
SJS830231					92
SJS830250					92
SJS830251					92
SJS830270					92
SJS830271					92
SJS831100					94
SJS831101					94
SJS831102					94
SJS831200					94
SJS831201					94
SJS831202					94
SJS831220					94
SJS831221					94
SJS831222					94
SJS840300					92
SJS840301					92
SJS840310					92
SJS840311					92
SJS840320					92
SJS840321					92
SJS840330					92
SJS840331					92
SJS840340					92
SJS840341					92
SJS840350					92
SJS840351					92



Réf /P/N AALBF	Réf /P/N EN 3708-	Réf /P/N OTAN	Réf / P/N M81714/..	Réf /P/N NSA	Page
SJS840400					93
SJS840401					93
SJS840410					93
SJS840411					93
SJS845000					93
SJS860500					93
SJS860501					93
SJS860510					93
SJS860511					93
SJS860520					93
SJS860521					93
SJS860900					94
SJS860901					94
SJS860910					94
SJS860911					94
SJS870510					93
SJS870511					93
SJS870520					93
SJS870521					93
SJS883000					94-95
SJS991000					94-95
SJT502404			67-2		99
SJT503404			67-3		99
SJT504404			67-4		99
SJT505404			67-5		99
SJT506404			67-6		99
SJT507404			67-7		99
SJT508404			67-8		99
SJT509404			67-9		99
SJT510404			67-10		99
SJT512404			67-12		99
SJT513404			67-13		99
SJT514404			67-14		99
SJT515404			67-15		99
SJT516404			67-16		99
SJT518404			67-18		99
SJT519404			67-19		99
SJT520404			67-20		99
SJT521404			67-21		99
SJT525404			67-25		99
SJT530404			67-30		99
SJT532404			67-32		99
SJT540404			67-40		99
SJTC02000			10-2		101
SJTC03000			10-3		101
SJTC04000			10-4		101
SJTC05000			10-5		101
SJTC06000			10-6		101
SJTC07000			10-7		101
SJTC08000			10-8		101
SJTC09000			10-9		101
SJTC10000			10-10		101
SJTC11000					101
SJTC12000			10-12		101
SJTC13000			10-13		101
SJTC14000			10-14		101
SJTC15000			10-15		101
SJTC16000			10-16		101
SJTC17000					101
SJTC18000			10-18		101
SJTC19000			10-19		101
SJTC20000			10-20		101
TJHD22700			17-D30		57
TJHD22701			17-D31		57
TJHD22702			17-D32		57



Réf /P/N AALBF	Réf /P/N EN 3708-	Réf /P/N OTAN	Réf / P/N M81714/..	Réf /P/N NSA	Page
TJHD22703			17-D33		57
TJHD22704			17-D34		57
TJHD22705			17-D35		57
TJHD22706			17-D36		57
TJHD22707			17-D37		57
TJM112701			4-DA1		56
TJM112702			4-DB1		56
TJM112703			4-DB2		56
TJM112705			4-DC1		56
TJM112706			4-DC2		56
TJM112707			4-DD1		56
TJM116701			3-DA1		56
TJM116702			3-DB1		56
TJM116703			3-DB2		56
TJM116705			3-DC1		56
TJM116706			3-DC2		56
TJM116707			3-DD1		56
TJM120701			2-DA1		55
TJM120702			2-DB1		55
TJM120703			2-DB2		55
TJM120704			2-DB3		55
TJM120705			2-DC1		55
TJM120706			2-DC2		55
TJM120707			2-DD1		55
TJM120708			2-DE1		55
TJM120710			2-DC3		55
TJM120711			2-DD2		55
TJM120712			2-DC4		55
TJM122701			1-DA1		54
TJM122702			1-DB1		54
TJM122703			1-DB2		54
TJM122704			1-DB3		54
TJM122705			1-DC1		54
TJM122706			1-DC2		54
TJM122707			1-DD1		54
TJM122708			1-DE1		54
TJM122710			1-DC3		54
TJM122711			1-DD2		54
TJM122712			1-DC4		54
TJM220701			7-DA1		55
TJM220702			7-DB1		55
TJM220703			7-DB2		55
TJM220704			7-DB3		55
TJM220705			7-DC1		55
TJM220706			7-DC2		55
TJM220707			7-DD1		55
TJM220708			7-DE1		55
TJM220709			7-DJ1		55
TJS312700			11-12D		90
TJS316700			11-16D		90
TJS316701			12-16D1		90
TJS316702			12-16D2		90
TJS320700			11-20D		90
TJS320701			12-20D1		90
TJS320702			12-20D2		90
TJS322700			11-22D		90
TJS322701			12-22D1		90
TJS322702			12-22D2		90
TJT701002					99
TJT701003			5-2		99
TJT701004			5-3		99
TJT701005			5-4		99
TJT701006			5-5		99
TJT701007			5-6		99
TJT701008			5-7		99

Réf /P/N AALBF	Réf /P/N EN 3708-	Réf /P/N OTAN	Réf / P/N M81714/..	Réf /P/N NSA	Page
TJT701009			5-8		99
TJT701010			5-1		99
TJT701011			5-9		99
TJT701012			5-10		99
TJT701013			5-11		99
TJT701014			5-12		99
TJT701015			5-13		99
TJT703002					99
TJT703003			16-2		99
TJT703004			16-3		99
TJT703005			16-4		99
TJT703006			16-5		99
TJT703007			16-6		99
TJT703008			16-7		99
TJT703009			16-8		99
TJT703010			16-1		99
TJT703011			16-9		99
TJT703012			16-10		99
TJT703013			16-11		99
TJT703014			16-12		99
TJT703015			16-13		99
TJT703016					99
TJT703017					99
TJT703018					99
TJT703019					99
TJT703020					99



Amphenol

Amphenol Air LB

Direction des Ventes / Sales office

Immeuble le Doublon - 11, Avenue Dubonnet
92407 COURBEVOIE Cedex - France

Tél. : (33) 01 49 05 30 00 - Fax : (33) 01 49 05 30 10

dircial@amphenol-airlb.fr

www.amphenol-airlb.fr

Siège social, Finances, R & D
Head Office, Finances, R & D



29, Voie d'Yvois
08110 BLAGNY - FRANCE

Centre de Production
Production Center



10, Rue Champ Raymond
08110 CARIGNAN - FRANCE

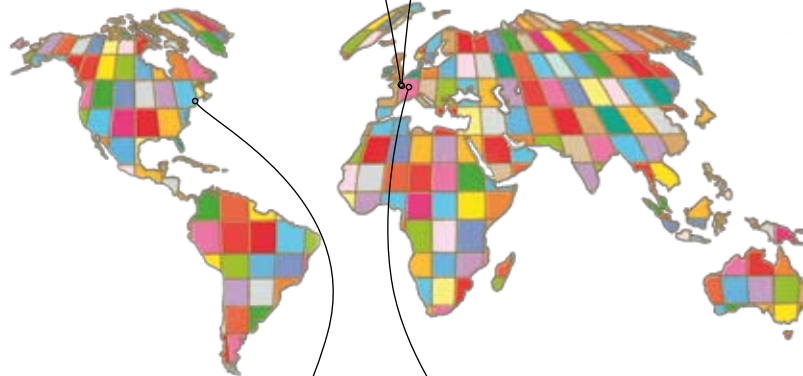

Amphenol Pcd



72 Cherry Hill Drive - Beverly, MA 01915 USA
Tel : (+1) 978 624.3400 - Fax: (+1) 978 927.1513
www.amphenolpcd.com
info@amphenolpcd.com

Amphenol Air LB GmbH



Am Kleinbahnhof 4 - D-66740 SAARLOUIS
Tél. : (49) 68 31 98 10 18 - Fax : (49) 68 31 98 10 30
www.amphenol-airlb.de
info@amphenol-airlb.de

Autres divisions Amphenol

More divisions on

www.amphenol.com

Ce document n'est pas contractuel. Les informations contenues dans ce catalogue sont susceptibles d'évolution.

Amphenol-Air LB se réserve le droit de procéder à des modifications sans préavis. Pour tout renseignement complémentaire, nous consulter.

This document is not a contractual document. The information included in this catalogue is subject to changes.

Amphenol-Air LB reserves the right to proceed with modifications without prior notice. For any additional information, do not hesitate to contact us.

X-ON Electronics

Largest Supplier of Electrical and Electronic Components

Click to view similar products for [Mounting Fixings](#) category:

Click to view products by [Amphenol](#) manufacturer:

Other Similar products are found below :

[5912235-1 REV](#) - [5912235-2](#) [007541](#) [627](#) [M3783-7001](#) [71-074914-006](#) [71-441549-19S](#) [75-69211-3P](#) [75-69214-6P](#) [75-69224-28P](#) [75-69224-5S](#) [75-69232-17S](#) [7717-8DAP](#) [85047GULPT](#) [85054GBEPR](#) [FPK-02-R10](#) [PMS27488-001-01](#) [1-18023-0](#) [H-118-2](#) [D83999/20WC8SN](#)
[DB1](#) [1302030464](#) [DC31-14W19PN](#) [DC31-14W19PW](#) [DC31E14-19PX](#) [DC31E14-19PY](#) [DC32-18W32SN](#) [DC36-18-32SW](#) [DC36-18-32SX](#)
[DC37-14-19PW](#) [DC37-22-21PX](#) [DC37E14-19PN](#) [DC37E14-19PX](#) [DC37E14-19PY](#) [1302010957](#) [1302263564](#) [1302340393](#) [1404-0016-78](#)
[14540](#) [149331-9811](#) [1561-60](#) [1566](#) [1566](#) [17542](#) [HS5659MB98PN](#) [NT20SATT01](#) [201C5058-01-201 REV E](#) [22594-8](#) [KBB-141](#) [915060](#)