

REV.	DATE	DESCRIPTION
A	10/12/03	MODIFY DRAWING FORMAT

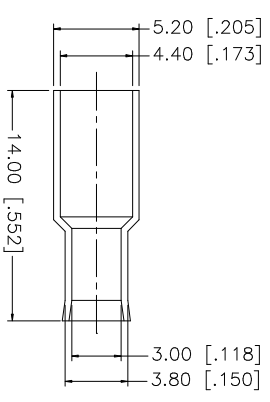
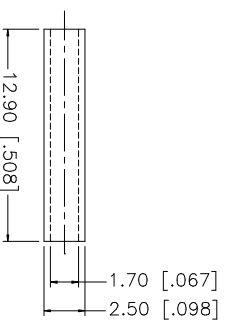
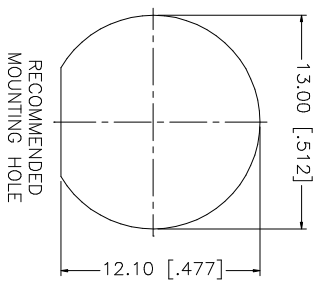
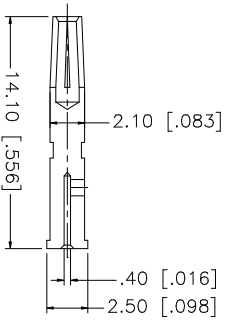
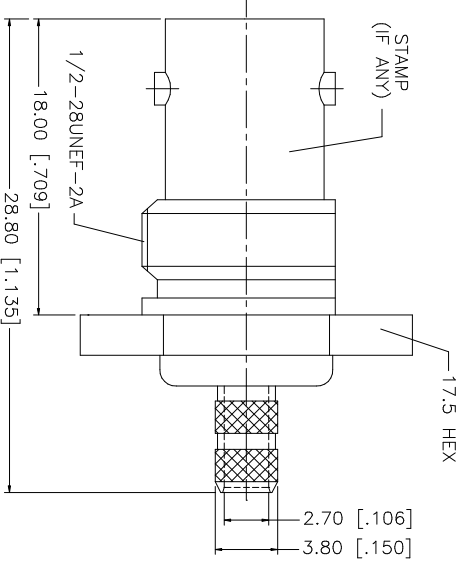
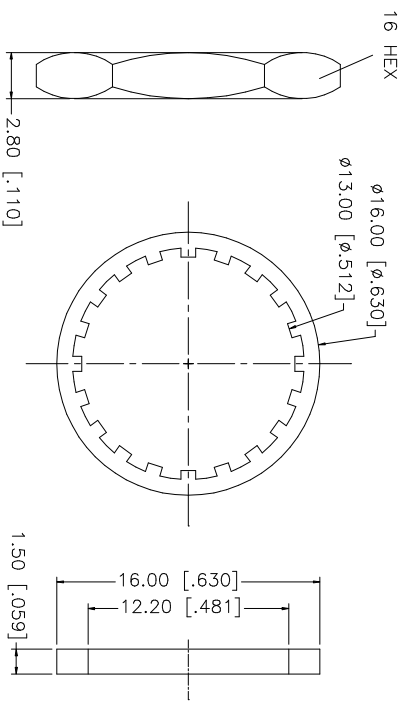
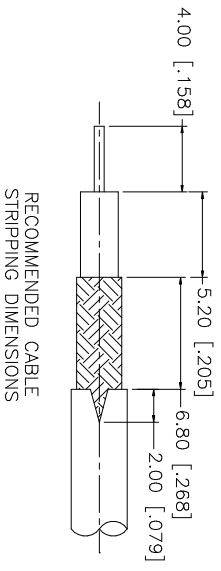

- NOTE:
1. CRIMPED FERRULE HEX CRIMP SIZE .178"
 2. CRIMPED CONTACT PIN HEX CRIMP SIZE .068"

QTY	DESCRIPTION	MATERIAL	FINISH
1	FERRULE	COPPER	NICKEL
1	SLEEVE	DELRIIN	NATURAL
1	HEX NUT	BRASS	NICKEL
1	LOCK WASHER	BRASS	NICKEL
1	GASKET	RUBBER	RED
1	CONTACT PIN	PHOS. BRONZE	GOLD
1	INSULATOR BODY	DELRIIN BRASS	NATURAL NICKEL

APPROVALS	DATE
G.R.S.	10/12/03

UNLESS OTHERWISE SPECIFIED DIMENSIONS ARE IN MILLIMETERS. DIMENSIONS IN [] ARE IN INCHES AND FOR CUSTOMER REFERENCE ONLY.
TOLERANCES FOR MILLIMETERS ARE: 0.5 - 8mm ± 0.20mm 8 - 30mm ± 0.40mm 30 - 120mm ± 0.50mm
TOLERANCES FOR INCHES ARE: .020 - .315 = ± 0.007" .315 - 1.180 = ± 0.015" 1.180 - 4.724 = ± 0.020"

DO NOT SCALE DRAWING
CAD FILE C:/112/112235.DWG

PART DESCRIPTION	PART NO.
BNC BULKHEAD CRIMP JACK (FOR RG-179/U, 187A/U)	112235

DWG. NO.	REV.	SIZE	SCALE
112235.DWG	A	A	NA

Amphenol Connex

X-ON Electronics

Largest Supplier of Electrical and Electronic Components

Click to view similar products for [RF Connectors / Coaxial Connectors](#) category:

Click to view products by [Amphenol](#) manufacturer:

Other Similar products are found below :

[8915-1511-000](#) [89674-0827](#) [6001-7071-019](#) [6002-7051-003](#) [6002-7551-202](#) [6059674-1](#) [619550-1](#) [630059-000](#) [M39030/3-01N](#) [M3933/25-36N](#) [6500-7071-046](#) [6769](#) [CX050L2AQ](#) [7002-1542-011](#) [7004-1512-000](#) [7009-1511-004](#) [7010-1511-000](#) [7029-1511-060](#) [7101-1541-010](#) [7101-1571-002](#) [7105-1521-002](#) [7145-1521-002](#) [7203-1571-003](#) [7209-1511-011](#) [7210-1511-015](#) [7210-1511-019](#) [73137-5015](#) [73216-2241](#) [7325-1512-000](#) [73404-2300](#) [7405-1521-005](#) [7405-1521-802](#) [7406-1521-005](#) [8527](#) [8547](#) [FS11V](#) [8808-1511-001](#) [9049-9513-000](#) [9074-9513-000](#) [9101-9573-002](#) [910A205F](#) [9130-9573-002](#) [PL11SC-026](#) [PL375-33](#) [PL40-5](#) [PL71-9](#) [PL74C-221](#) [PL75MC-217](#) [PL803-7](#) [980-8666-005](#)