

REV.	DATE	DESCRIPTION
NC	12/10/97	INITIAL RELEASE

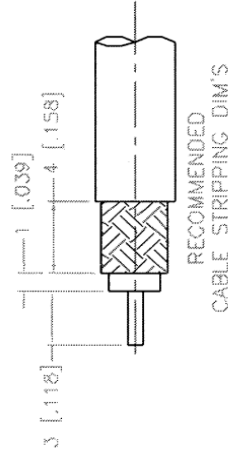

DESCRIPTION	MATERIAL	FINISH	UNLESS OTHERWISE SPECIFIED DIMENSIONS ARE IN MILLIMETERS DIMENSIONS IN [] ARE IN INCHES FOR CUSTOMER REFERENCE ONLY	APPROVALS	DATE
1 BODY	BRASS	NICKEL	UNLESS OTHERWISE SPECIFIED TOLERANCES FOR MILLIMETERS ARE: 0.5-6 = ± 0.2 6-30 = ± 0.4 30-120 = ± 0.6 120-315 = ± 1 315-1000 = ± 1.6 1000-2000 = ± 2.4	DRAWN	12/10/97
2 INSULATOR	DELTRIN	NATURAL		CHECKED	
3 TOP HAT	BRASS	NICKEL		ISSUED	
4 GASKET	SILICONE	RED			
5 WASHER	BRASS	NICKEL			
6 HEX NUT	BRASS	NICKEL			
7 CONTACT PIN	BRASS	GOLD			
8				DO NOT SCALE DRAWING	

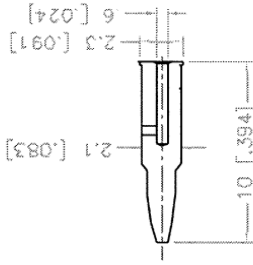
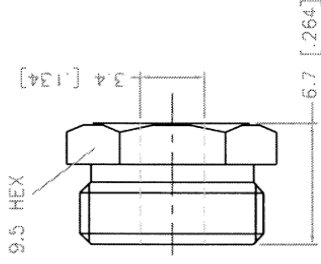
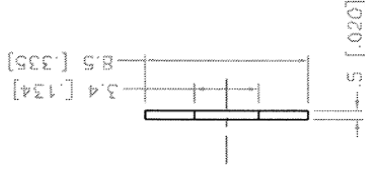
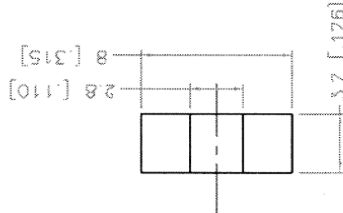
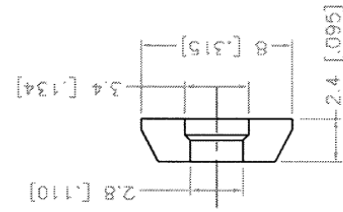
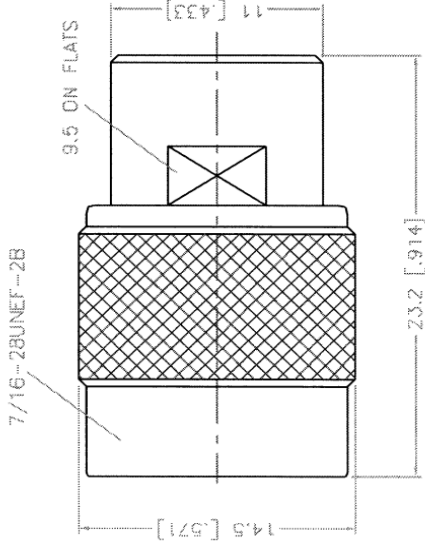

TITLE		TNC CLAMP PLUG
DWG. NO.		RG174, 316 CABLE
SIZE	FSCM NO.	REV.
A	99001	NC
SCALE	PART NO.	DWG. NO.
NA	122402	122402.DWG
SHEET	1 OF 1	

X-ON Electronics

Largest Supplier of Electrical and Electronic Components

Click to view similar products for [RF Connectors / Coaxial Connectors](#) category:

Click to view products by [Amphenol](#) manufacturer:

Other Similar products are found below :

[8915-1511-000](#) [89674-0827](#) [6001-7071-019](#) [6002-7051-003](#) [6002-7551-202](#) [6059674-1](#) [619550-1](#) [630059-000](#) [M39030/3-01N](#) [M3933/25-36N](#) [6500-7071-046](#) [6769](#) [CX050L2AQ](#) [7002-1542-011](#) [7004-1512-000](#) [7009-1511-004](#) [7010-1511-000](#) [7029-1511-060](#) [7101-1541-010](#) [7101-1571-002](#) [7105-1521-002](#) [7145-1521-002](#) [7203-1571-003](#) [7209-1511-011](#) [7210-1511-015](#) [7210-1511-019](#) [73137-5015](#) [73216-2241](#) [7325-1512-000](#) [73404-2300](#) [7405-1521-005](#) [7405-1521-802](#) [7406-1521-005](#) [8527](#) [8547](#) [FS11V](#) [8808-1511-001](#) [9049-9513-000](#) [9074-9513-000](#) [9101-9573-002](#) [910A205F](#) [9130-9573-002](#) [PL11SC-026](#) [PL375-33](#) [PL40-5](#) [PL71-9](#) [PL74C-221](#) [PL75MC-217](#) [PL803-7](#) [980-8666-005](#)