

This document is the property of Amphenol Corporation and is delivered on the express condition that it is not to be disclosed, reproduced or used, in whole or in part, for manufacture or sale by anyone other than Amphenol Corporation without its prior consent, & that no right is granted to disclose or to use any information in this document.

# REFERENCE DRAWING

REVISIONS				
SYM	ECN	DESCRIPTION	DATE	APPROVED
A2	1602****	CHANGE THE STRUCTURE	02/23/16	Tom

Pin	Signal Name	Mating Sequence	Pin	Signal Name	Mating Sequence
A1	GND	First	B12	GND	First
A2	TX1+	Second	B11	RX1+	Second
A3	TX1-	Second	B10	RX1-	Second
A4	V <sub>BUS</sub>	First	B9	V <sub>BUS</sub>	First
A5	CC1	Second	B8	SBU2	Second
A6	D+	Second	B7		
A7	D-	Second	B6		
A8	SBU1	Second	B5	V <sub>conn</sub>	Second
A9	V <sub>BUS</sub>	First	B4	V <sub>BUS</sub>	First
A10	RX2-	Second	B3	TX2-	Second
A11	RX2+	Second	B2	TX2+	Second
A12	GND	First	B1	GND	First
SHELL		GND	SHELL		GND

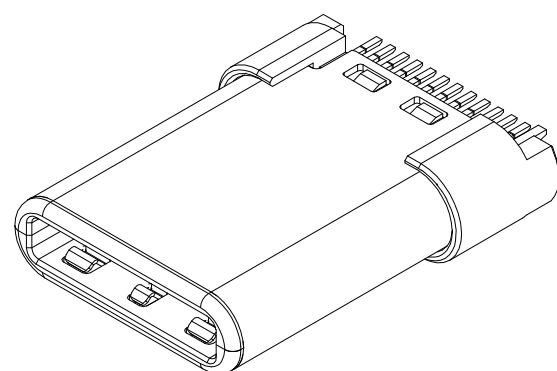
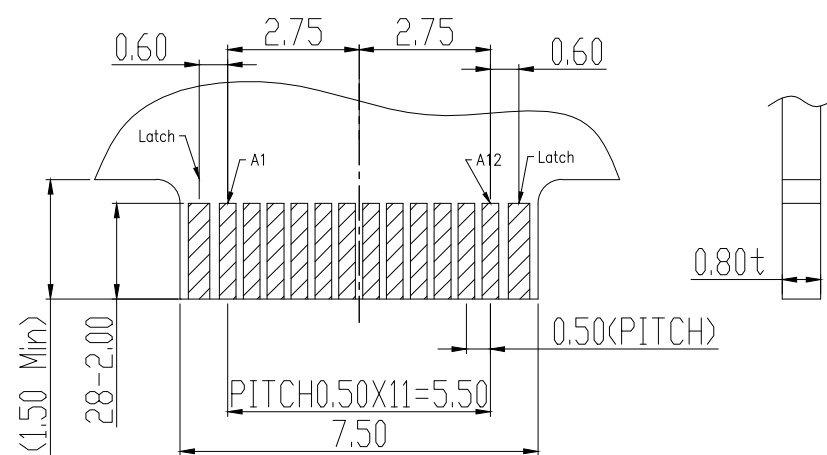
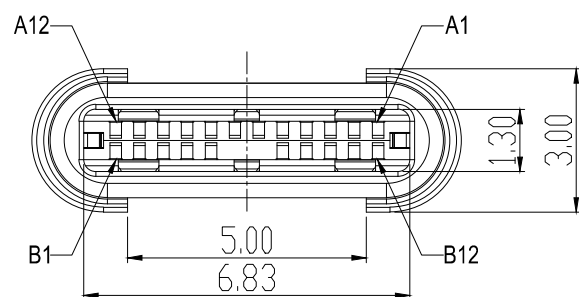
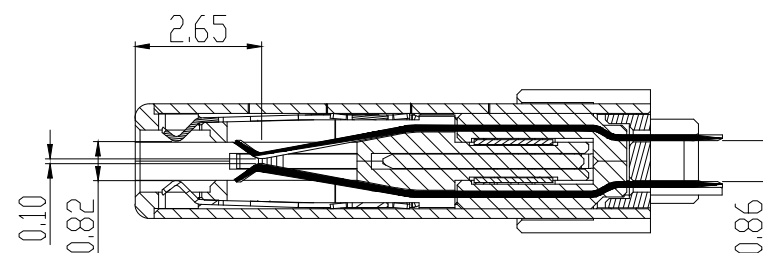
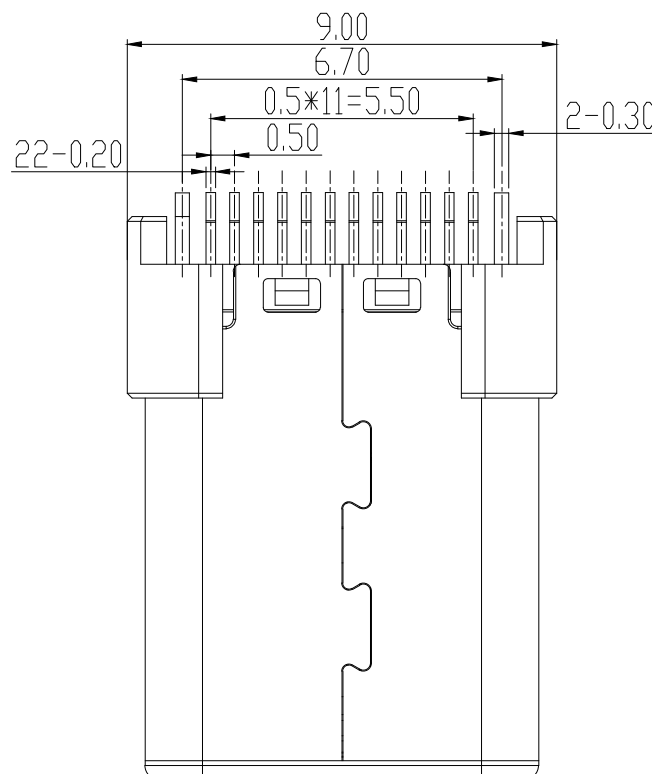
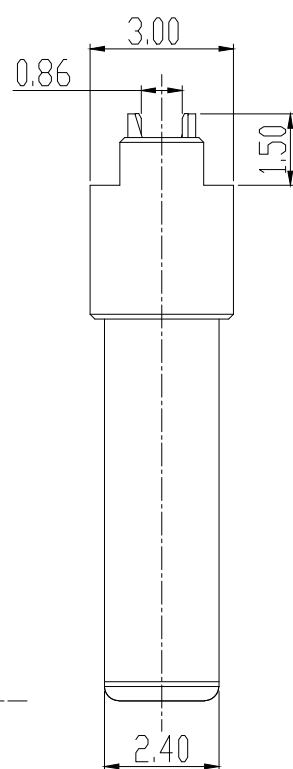
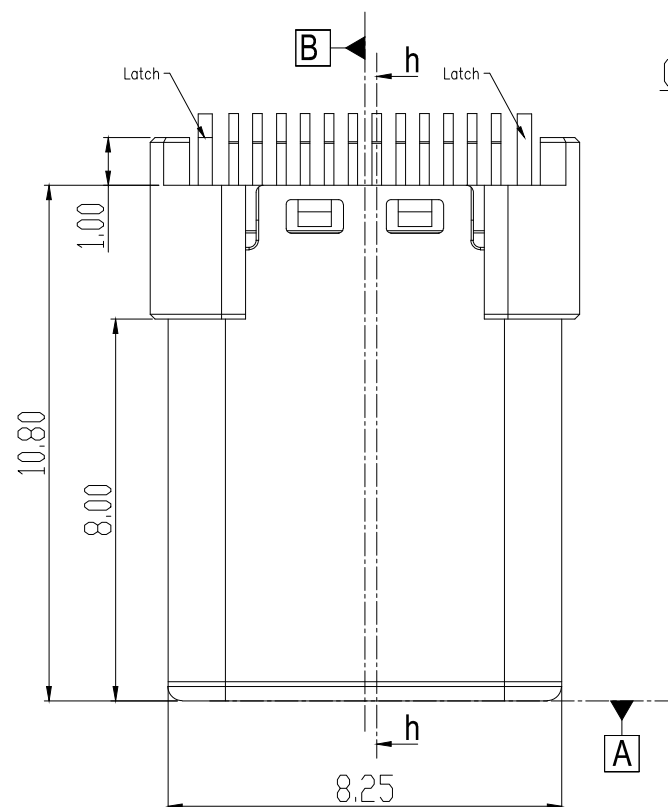
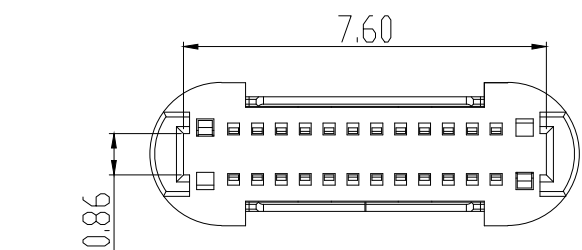

Notes:

- Material :
  - Contacts : copper alloy
  - Shell : stainless steel
  - Housing : High-temperature polymer UL94V-0, black.
- Plating :
  - Contacts : contact area 30u" Au, solder tail 100u" Matte Tin. all area 50u" Nickel plating.
  - Shell : Nickel Plating
- Coplanarity : 0.08Max.
- P/N : 12401562E4#2A.
- Packaging type: carrier tape.
- Material should be fulfilled Amphenol spec# SSN002 AND Customer Requirements, for halogen free products, also need to meet SSN004

UNLESS OTHERWISE SPECIFIED TOLERANCES U.S. METRIC .X +/- / ±0.30 .XX +/- / ±0.25 .XXX +/- / ±0.20 FRACTIONS +/- / ANGLES +/- /	APPROVAL	DATE	TITLE USB TYPE C PLUG STRADDLE MOUNT
	DRAWN Michael.Qin	02/23/16	
	CHECKED Weison.Lu	02/23/16	
	CHECKED		
FOR MATERIALS AND FINISHES SEE NOTES	DRAWING FILE :		SIZE
REMOVE SHARP EDGES	ANGLE OF PROJECTION		DRAWING NO.
DIMENSIONS			REV.
U.S. INCHES-			A3 12401562E4#2A
(METRIC) (MM)			SCALE NONE SHEET 1 OF 1

## X-ON Electronics

Largest Supplier of Electrical and Electronic Components

*Click to view similar products for [USB Connectors](#) category:*

*Click to view products by [Amphenol](#) manufacturer:*

Other Similar products are found below :

[65-647-8-BK-BU](#) [950](#) [952](#) [E8144-B01021-L](#) [A-USB A-LP-SMT-C](#) [A-USB B-TOP-C](#) [MUSBA511N5](#) [MUSBD11135](#) [217450-1](#) [CA 6 W LD](#)  
[KMBVX-TH-5S-B30](#) [896-30-004-00-000000](#) [KUSBVX-BS1N-W30](#) [KUSBX-AP-KIT-SCBLK](#) [KUSBX-AS2N-W](#) [KUSBX-SMT2AP1S-W](#)  
[KUSBX-SMT2AP1S-W30](#) [935](#) [957](#) [30-498-6](#) [17-210051](#) [1734082-1](#) [30-1574](#) [30-470](#) [30-489](#) [30-541](#) [30-572-3](#) [MAB 8 SN V](#) [A-USB A-](#)  
[2P-C](#) [MIKROE-1451](#) [USBFTV2PEM2G](#) [USBFTVC6ZN](#) [KUSBX-AS2N-W30](#) [KUSBX-SLAS1N-W](#) [KUSBX-SMT-AS1N-W30](#) [4689-1](#) [1-](#)  
[1734084-2](#) [E8110-001-01](#) [MUSBA81130](#) [33UBARS1-04SW11](#) [33UBAR-04SW11](#) [USBF21ZNSCC](#) [USBBFTV6ZC](#) [10135326-001LF](#)  
[M9177/3-1](#) [USB-A-S-F-B-VT](#) [925](#) [4198](#) [690-024-633-031](#) [KUSBEX-BSFS1N-W](#)