

REV.	DATE	ECR NO.	DESCRIPTION
NC	06/21/99	-	INITIAL RELEASE
A	08/22/08	-	UPDATE DRAWING FORMAT

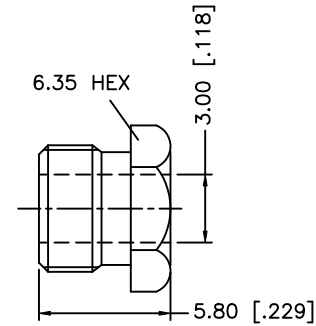
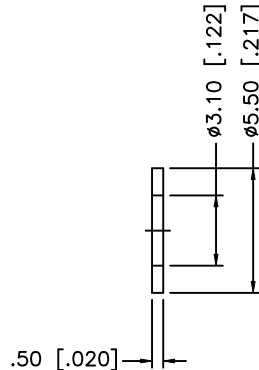
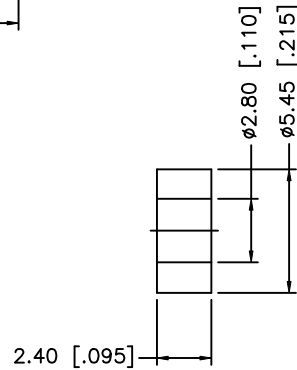
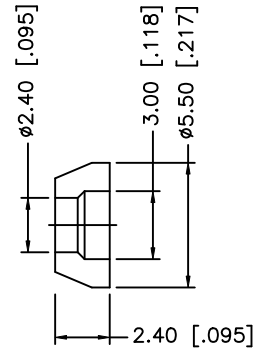
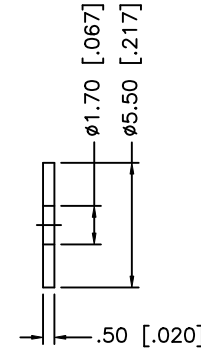
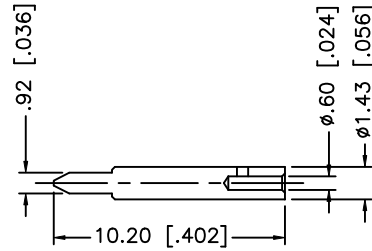
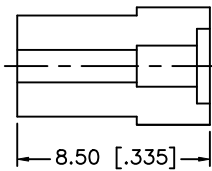
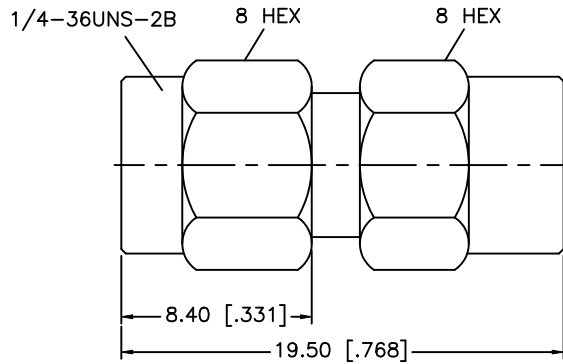
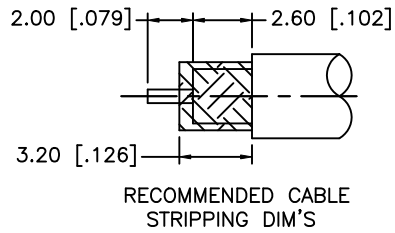

9	HEX NUT	BRASS	GOLD	1
8	WASHER	BRASS	GOLD	1
7	GASKET	SILICONE	RED	1
6	TOP HAT	BRASS	GOLD	1
5	WASHER	BRASS	GOLD	1
4	CONTACT PIN	BRASS	GOLD	1
3	INSULATOR	PTFE	NATURAL	1
2	BODY	BRASS	GOLD	1
1	SHELL	BRASS	GOLD	1
	DESCRIPTION	MATERIAL	FINISH	QTY

UNLESS OTHERWISE SPECIFIED DIMENSIONS ARE IN MILLIMETERS. DIMENSIONS IN [ ] ARE IN INCHES AND FOR CUSTOMER REFERENCE ONLY.

UNLESS OTHERWISE SPECIFIED TOLERANCES FOR MILLIMETERS ARE:  
0.5 - 8mm ± 0.20mm  
8 - 30mm ± 0.40mm  
30 - 120mm ± 0.50mm

UNLESS OTHERWISE SPECIFIED TOLERANCES FOR INCHES ARE:  
.020 - .315 ± 0.007"  
.315 - 1.180 ± 0.015"  
1.180 - 4.724 ± 0.020"

DO NOT SCALE DRAWING

APPROVALS	DATE
DRAWN GRS	08/22/08
CHECKED	
ISSUED	
SHEET 1 OF 1	
CAD FILE	C:/132/132124.DWG

<h1>Amphenol Connex</h1>			
PART DESCRIPTION <b>SMA CLAMP PLUG</b> (RG-174/U, 188A/U, 316/U CABLE)			
PART NO. <b>132124</b>			
DWG. NO.	132124.DWG	REV.	A
SIZE	A	SCALE	NA

## X-ON Electronics

Largest Supplier of Electrical and Electronic Components

*Click to view similar products for [RF Connectors / Coaxial Connectors](#) category:*

*Click to view products by [Amphenol](#) manufacturer:*

Other Similar products are found below :

[8915-1511-000](#) [89674-0827](#) [6001-7071-019](#) [6002-7051-003](#) [6002-7551-202](#) [6059674-1](#) [619550-1](#) [630059-000](#) [M39030/3-01N](#) [M3933/25-36N](#) [6500-7071-046](#) [6769](#) [CX050L2AQ](#) [7002-1542-011](#) [7004-1512-000](#) [7009-1511-004](#) [7010-1511-000](#) [7029-1511-060](#) [7101-1541-010](#) [7101-1571-002](#) [7105-1521-002](#) [7145-1521-002](#) [7203-1571-003](#) [7209-1511-011](#) [7210-1511-015](#) [7210-1511-019](#) [73137-5015](#) [73216-2241](#) [7325-1512-000](#) [73404-2300](#) [7405-1521-005](#) [7405-1521-802](#) [7406-1521-005](#) [8527](#) [8547](#) [FS11V](#) [8808-1511-001](#) [9049-9513-000](#) [9074-9513-000](#) [9101-9573-002](#) [910A205F](#) [9130-9573-002](#) [PL11SC-026](#) [PL375-33](#) [PL40-5](#) [PL71-9](#) [PL74C-221](#) [PL75MC-217](#) [PL803-7](#) [980-8666-005](#)