

- NOTES:
- MATERIAL AND FINISH (PLATING THICKNESS IN MICRO-INCHES):
 BODY - BRASS, GOLD PLATING
 CONTACT - BRASS, GOLD PLATING
 INSULATOR - PTFE, NATURAL
 - ELECTRICAL:
 A. IMPEDANCE: 50 OHM
 B. FREQUENCY RANGE: DC 0-12.4 GHz
 C. DIELECTRIC WITHSTANDING VOLTAGE: 1000 VRMS. MIN.
 - MECHANICAL:
 A. DURABILITY: 500 CYCLES MIN.
 B. TEMPERATURE RANGE: -65°C to + 165°C
 - MAX. PANEL THICKNESS 2.4mm

THIRD ANGLE PROJ.

REVISIONS

REV	DESCRIPTION	DATE	ECO	APPR
A	RELEASE TO MFG.	07-Feb-12		MZ
C	HOUSING WITH BODY WAS CHANGED; SYNC UP THE REVISION WITH CONNEX/RD-DMI5031001S2	4/2/15	50459	

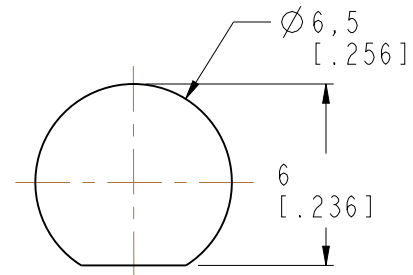

RECOMMENDED MOUNTING HOLE

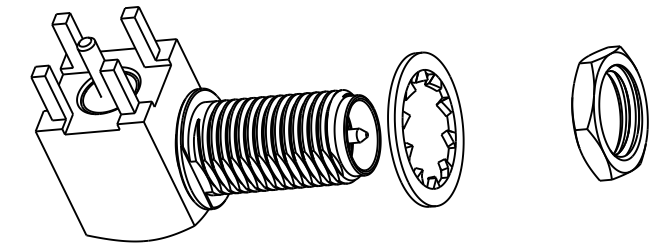
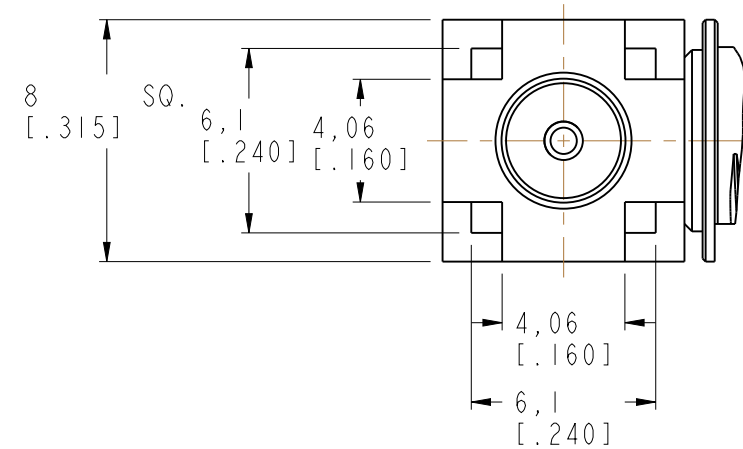

SCALE 2.000

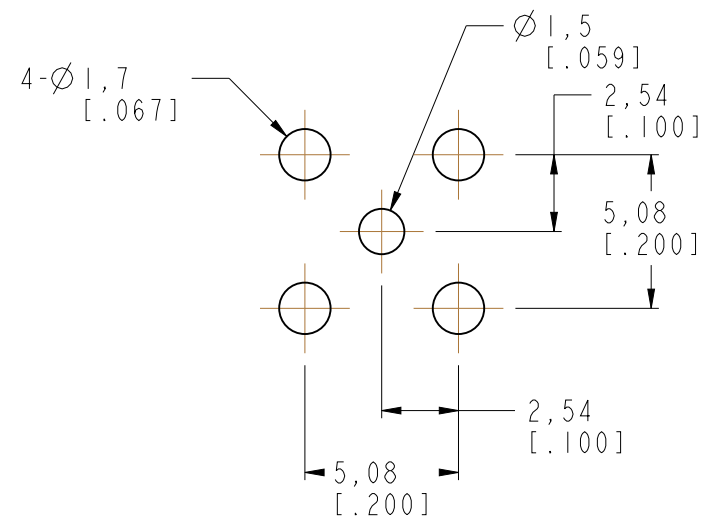

PCB MOUNTING HOLES

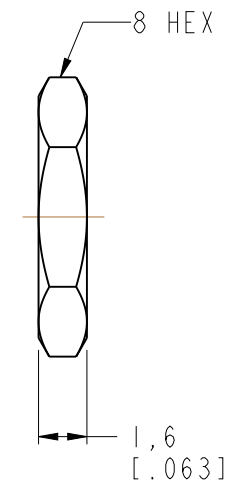
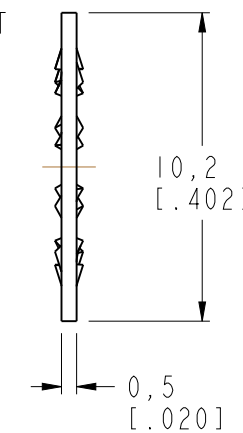
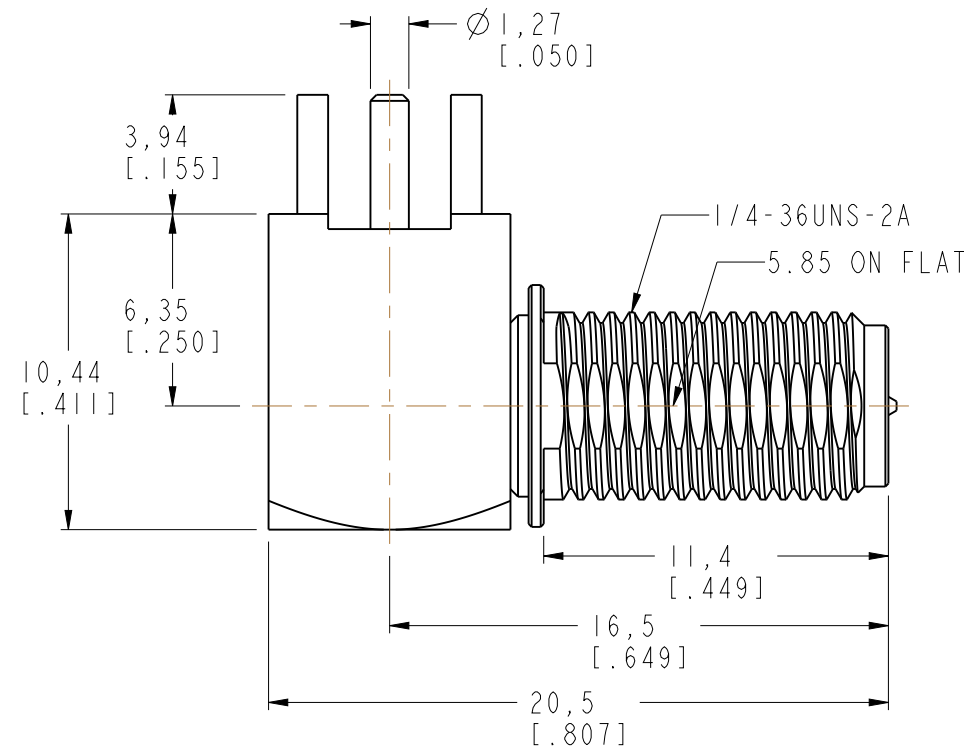

CUSTOMER OUTLINE DRAWING

ALL OTHER SHEETS ARE FOR INTERNAL USE ONLY

UNLESS OTHERWISE SPECIFIED, DIMENSIONS ARE IN METRIC AND TOLERANCES ARE:
 <0.5mm ±0.05mm 0.5 - 6mm ±0.1mm 6 - 30mm ±0.2mm 30 - 120mm ±0.3mm ANGLES ±1°

NOTICE - These drawings, specifications, or other data (1) are, and remain the property of Amphenol corp. (2) must be returned upon request; and (3) are confidential and not to be disclosed to any person other than those to whom they are given by Amphenol Corp. the furnishing of these drawings, specifications, or other data by Amphenol Corp., or to any other person to anyone for any purpose is not to be regarded by implication or otherwise in any manner licensing, granting rights to permitting such holder or any other person to manufacture, use or sell any product, process or design, patented or otherwise, that may in any way be related to or disclosed by said drawings, specifications, or other data.

MATERIAL	DRAWN STAR	DATE 01-Apr-15	TITLE SMA REVERSE POLARITY R/A BULKHEAD P.C. MOUNT JACK	Amphenol Connex
REFERENCE RSMA6252A9-3GT5GP-50	ENGINEER S.LI	DATE 07-Feb-12	SCALE: 4.0:1.0 SHEET 3 OF 3	
FINISH	APPROVED S.HSIEH	DATE 01-Apr-15	DWG SIZE B	DRAWING NO.
	CAD FILE I:\RSMA\RSMA6252A9-3GT5GP-50		REV C	ITEM NO.
				PART NO. 132203RP

X-ON Electronics

Largest Supplier of Electrical and Electronic Components

Click to view similar products for [RF Connectors / Coaxial Connectors](#) category:

Click to view products by [Amphenol](#) manufacturer:

Other Similar products are found below :

[8915-1511-000](#) [89674-0827](#) [6001-7071-019](#) [6002-7051-003](#) [6002-7551-202](#) [6059674-1](#) [619550-1](#) [630059-000](#) [M39030/3-01N](#) [M3933/25-36N](#) [6500-7071-046](#) [6769](#) [CX050L2AQ](#) [7002-1542-011](#) [7004-1512-000](#) [7009-1511-004](#) [7010-1511-000](#) [7029-1511-060](#) [7101-1541-010](#) [7101-1571-002](#) [7105-1521-002](#) [7145-1521-002](#) [7203-1571-003](#) [7209-1511-011](#) [7210-1511-015](#) [7210-1511-019](#) [73137-5015](#) [73216-2241](#) [7325-1512-000](#) [73404-2300](#) [7405-1521-005](#) [7405-1521-802](#) [7406-1521-005](#) [8527](#) [8547](#) [FS11V](#) [8808-1511-001](#) [9049-9513-000](#) [9074-9513-000](#) [9101-9573-002](#) [910A205F](#) [9130-9573-002](#) [PL11SC-026](#) [PL375-33](#) [PL40-5](#) [PL71-9](#) [PL74C-221](#) [PL75MC-217](#) [PL803-7](#) [980-8666-005](#)