

REV.	DATE	DESCRIPTION
NC	12/13/00	INITIAL RELEASE
A	05/06/07	REVISE BARREL/FERRULE DIMENSIONS/UPDATE DRAWING FORMAT
B	01/06/08	ADD CABLE CALL OUT IN DESCRIPTION. REMOVE NOTE 2

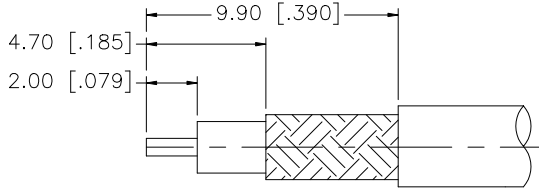

RECOMMENDED CABLE STRIPPING DIM'S

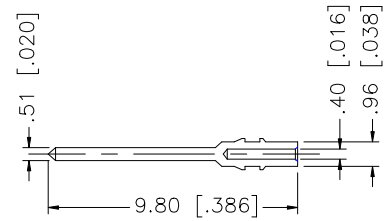
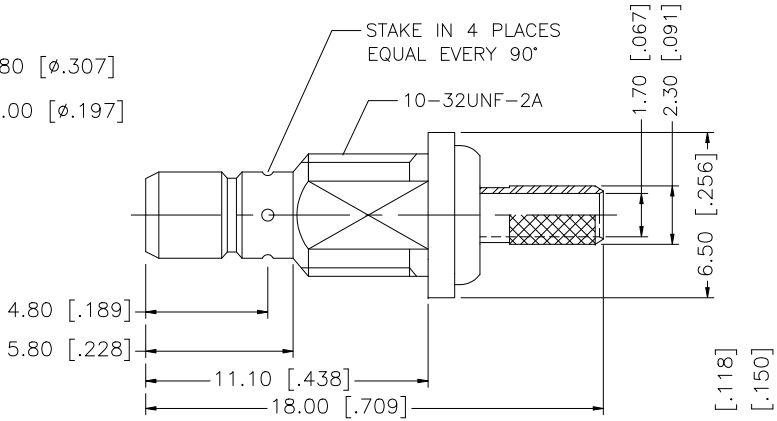
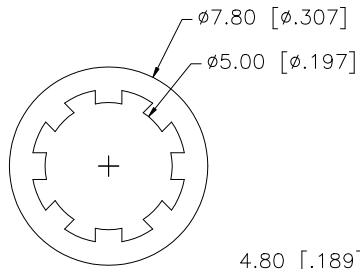
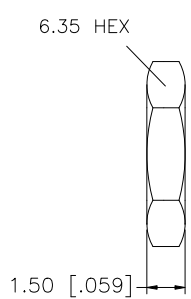
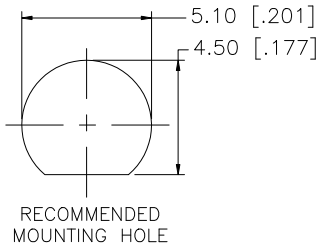
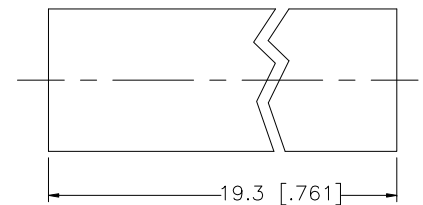
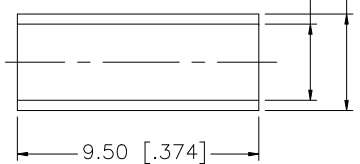

NOTE:
1. CRIMPED FERRULE HEX CRIMP SIZE .128"

QTY	DESCRIPTION	MATERIAL	FINISH
1	HEAT SHRINK TUBE	BLACK	
1	HEX NUT	BRASS	NICKEL
1	LOCK WASHER	BRASS	NICKEL
1	FERRULE	COPPER	NICKEL
1	CONTACT PIN	BRASS	GOLD
1	INSULATOR	TEFLON	NATURAL
1	BODY	BRASS	NICKEL

UNLESS OTHERWISE SPECIFIED DIMENSIONS ARE IN MILLIMETERS. DIMENSIONS IN [] ARE IN INCHES AND FOR CUSTOMER REFERENCE ONLY.

UNLESS OTHERWISE SPECIFIED TOLERANCES FOR MILLIMETERS ARE:
0.5 - 8mm ± 0.20mm
8 - 30mm ± 0.40mm
30 - 120mm ± 0.50mm

UNLESS OTHERWISE SPECIFIED TOLERANCES FOR INCHES ARE:
.020 - .315 = ± 0.007"
.315 - 1.180 = ± 0.015"
1.180 - 4.724 = ± 0.020"

DO NOT SCALE DRAWING

APPROVALS	DATE
DRAWN G.R.S.	01/06/08
CHECKED	
ISSUED	
SHEET 1 OF 1	
CAD FILE C:/142/142179-75.DWG	

Amphenol Connex

PART DESCRIPTION
**MINI SMB BULKHEAD CRIMP JACK
(FOR RG-179/U, 187/U CABLE)**

PART NO.
142179-75

DWG. NO.	142179-75.DWG	REV.	B	SIZE	A	SCALE	NA
----------	---------------	------	---	------	---	-------	----

X-ON Electronics

Largest Supplier of Electrical and Electronic Components

Click to view similar products for [RF Connectors / Coaxial Connectors](#) category:

Click to view products by [Amphenol](#) manufacturer:

Other Similar products are found below :

[8915-1511-000](#) [89674-0827](#) [6001-7071-019](#) [6002-7051-003](#) [6002-7551-202](#) [6059674-1](#) [619550-1](#) [630059-000](#) [M39030/3-01N](#) [M3933/25-36N](#) [6500-7071-046](#) [6769](#) [CX050L2AQ](#) [7002-1542-011](#) [7004-1512-000](#) [7009-1511-004](#) [7010-1511-000](#) [7029-1511-060](#) [7101-1541-010](#) [7101-1571-002](#) [7105-1521-002](#) [7145-1521-002](#) [7203-1571-003](#) [7209-1511-011](#) [7210-1511-015](#) [7210-1511-019](#) [73137-5015](#) [73216-2241](#) [7325-1512-000](#) [73404-2300](#) [7405-1521-005](#) [7405-1521-802](#) [7406-1521-005](#) [8527](#) [8547](#) [FS11V](#) [8808-1511-001](#) [9049-9513-000](#) [9074-9513-000](#) [9101-9573-002](#) [910A205F](#) [9130-9573-002](#) [PL11SC-026](#) [PL375-33](#) [PL40-5](#) [PL71-9](#) [PL74C-221](#) [PL75MC-217](#) [PL803-7](#) [980-8666-005](#)