

REV.	DATE	DESCRIPTION
NC	09/07/99	INITIAL RELEASE
A	07/21/05	UPDATE DRAWING FORMAT

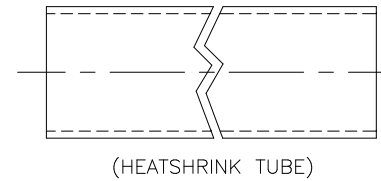
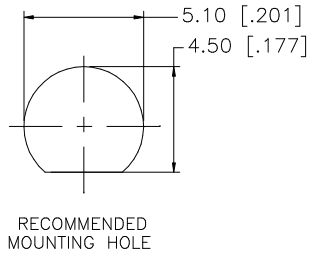
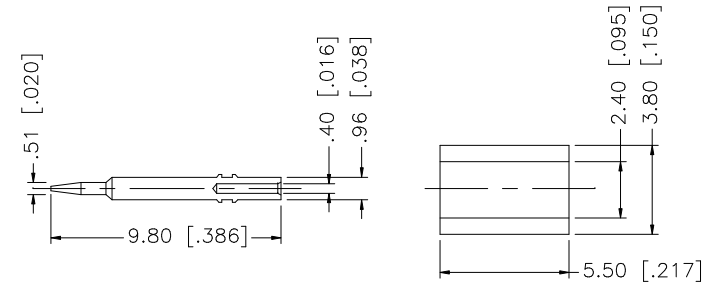
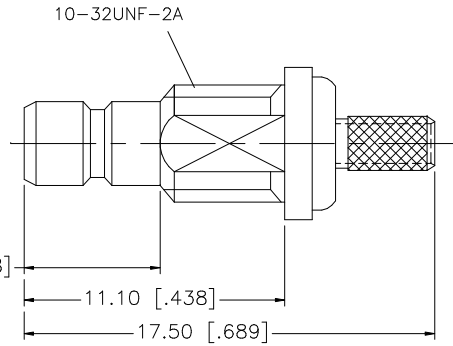
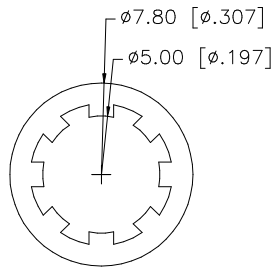
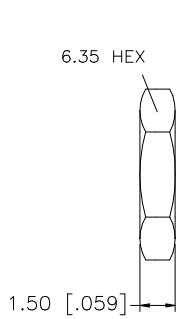
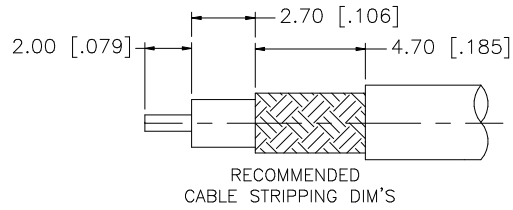

QTY	DESCRIPTION	MATERIAL	FINISH	QTY	DO NOT SCALE DRAWING	APPROVALS	DATE	Amphenol Connex								
1	HEAT SHRINK TUBE			1	<small>UNLESS OTHERWISE SPECIFIED DIMENSIONS ARE IN MILLIMETERS. DIMENSIONS IN [] ARE IN INCHES AND FOR CUSTOMER REFERENCE ONLY.</small> <small>UNLESS OTHERWISE SPECIFIED TOLERANCES FOR MILLIMETERS ARE:</small> 0.5 - 8mm ± 0.20mm 8 - 30mm ± 0.40mm 30 - 120mm ± 0.50mm <small>UNLESS OTHERWISE SPECIFIED TOLERANCES FOR INCHES ARE:</small> .020 - .315 = ± 0.007" .315 - 1.180 = ± 0.015" 1.180 - 4.724 = ± 0.020"	DRAWN	G.R.S.	07/21/05	SMB BULKHEAD CRIMP JACK (FOR RG-178B/U, 196A/U CABLE)							
1	FERRULE	COPPER	GOLD	1		CHECKED							PART DESCRIPTION			
1	HEX NUT	BRASS	GOLD	1		ISSUED							PART NO.			
1	LOCK WASHER	BRASS	GOLD	1					142231							
1	CONTACT PIN	BRASS	GOLD	1					DWG. NO. 1421231.DWG							
1	INSULATOR	TEFLON	NATURAL	1					REV. A							
1	BODY	BRASS	GOLD	1					SIZE A							
									SCALE NA							
								CAD FILE C:/142/142231.DWG								

X-ON Electronics

Largest Supplier of Electrical and Electronic Components

Click to view similar products for [RF Connectors / Coaxial Connectors](#) category:

Click to view products by [Amphenol](#) manufacturer:

Other Similar products are found below :

[8915-1511-000](#) [89674-0827](#) [6001-7071-019](#) [6002-7051-003](#) [6002-7551-202](#) [6059674-1](#) [619550-1](#) [630059-000](#) [M39030/3-01N](#) [M3933/25-36N](#) [6500-7071-046](#) [6769](#) [CX050L2AQ](#) [7002-1542-011](#) [7004-1512-000](#) [7009-1511-004](#) [7010-1511-000](#) [7029-1511-060](#) [7101-1541-010](#) [7101-1571-002](#) [7105-1521-002](#) [7145-1521-002](#) [7203-1571-003](#) [7209-1511-011](#) [7210-1511-015](#) [7210-1511-019](#) [73137-5015](#) [73216-2241](#) [7325-1512-000](#) [73404-2300](#) [7405-1521-005](#) [7405-1521-802](#) [7406-1521-005](#) [8527](#) [8547](#) [FS11V](#) [8808-1511-001](#) [9049-9513-000](#) [9074-9513-000](#) [9101-9573-002](#) [910A205F](#) [9130-9573-002](#) [PL11SC-026](#) [PL375-33](#) [PL40-5](#) [PL71-9](#) [PL74C-221](#) [PL75MC-217](#) [PL803-7](#) [980-8666-005](#)