

REV.	DATE	DESCRIPTION
NC	03/06/00	INITIAL RELEASE

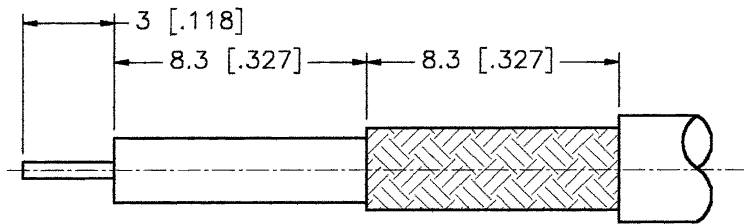

RECOMMENDED
CABLE STRIPPING DIM'S

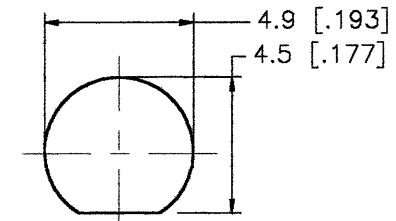

RECOMMENDED
MOUNTING HOLE

6 HEX NUT

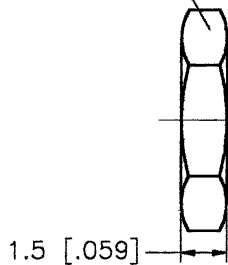

$\phi 7.8$ [$\phi .307$]
 $\phi 5$ [$\phi .197$]

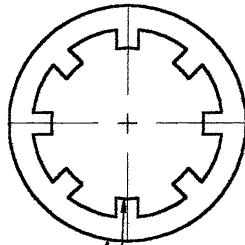

10-32UNF-2A

8 HEX

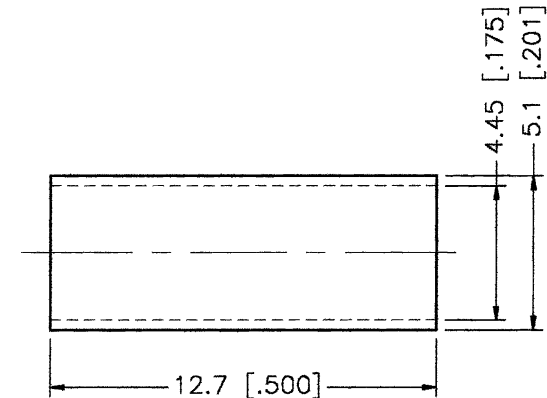
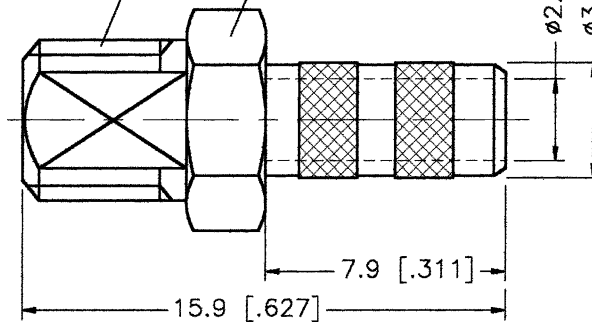

CRIMP NOTES:

1. CRIMPED FERRULE
HEX CRIMP SIZE .178"

DESCRIPTION	MATERIAL	FINISH	UNLESS OTHERWISE SPECIFIED DIMENSIONS ARE IN MILLIMETERS	APPROVALS	DATE	 Connex Connector Corporation						
1	BODY	BRASS	NICKEL	DRAWN	G.R.S.					03/06/00	TITLE BULKHEAD CABLE TERMINATION (FOR RG-180B/U, 195/U CABLE)	
2	FERRULE	COPPER	NICKEL	CHECKED			SIZE A					
3	LOCK WASHER	BRASS	NICKEL	ISSUED							FSCM NO.	DWG. NO.
4	HEX NUT	BRASS	NICKEL				99001	142276.DWG	NC			
5												
6												
7												
8			DO NOT SCALE DRAWING				SCALE	NA	PART NO.	142276	SHEET	1 OF 1

UNLESS OTHERWISE SPECIFIED
TOLERANCES FOR MILLIMETERS ARE:
 0.5-6 = ± 0.2
 6-30 = ± 0.4
 30-120 = ± 0.6
 120-315 = ± 1
 315-1000 = ± 1.6
 1000-2000 = ± 2.4

DIMENSIONS IN [] ARE IN INCHES
FOR CUSTOMER REFERENCE ONLY

X-ON Electronics

Largest Supplier of Electrical and Electronic Components

Click to view similar products for [RF Terminators](#) category:

Click to view products by [Amphenol](#) manufacturer:

Other Similar products are found below :

[M390303-02N](#) [M39030/3-04S](#) [M39030/3-09S](#) [TNG1-9-78-D3](#) [TNA2-50](#) [TNG1-6-78](#) [TNH1-1-50](#) [R404280000](#) [TNGFL1-1-78](#) [R4042N5000](#)
[R404518000](#) [53S1RR-001N3](#) [142275](#) [56S1RR-001N4](#) [18S15R-0.5E3](#) [65_BNC-50-0-7/133_NE](#) [71S1RR-001N4](#) [02S17R-001D3](#)
[R404240120](#) [R404260000](#) [HT-10-2](#) [M39030/3-04N](#) [TNA1-6-50](#) [131-3801-811](#) [TNA1-1-50](#) [65_N-50-0-51/113_NE](#) [65_N-50-0-1/133_NE](#)
[65002_N-50-1/122_NE](#) [65_MMCX-50-0-31/111_OE](#) [18K15R-0.5E3](#) [2702702](#) [TRM-2161-M0-35M-02](#) [53S17R-001N3](#) [18S24H-40ML5](#)
[TRM-2053-M0-NNN-02](#) [R404759000](#) [M39030/6-02N](#) [TRM-2080-M0-NNN-07](#) [TRM-2053-MC-NNN-02](#) [M39030/3-03S](#) [SF8012-6009](#)
[6701.01.A](#) [65_716-50-0-2/003_-E](#) [65_SMB-50-0-1/111_NE](#) [M39030/3-12N](#) [M39030/5-06N](#) [82-5722-RFX](#) [8018-6174](#) [SF8018-6005](#) [000-46650-51RFX](#)