

| REV. | DATE     | DESCRIPTION           |
|------|----------|-----------------------|
| A    | 08/28/00 | REVISE OLD PRINT      |
| B    | 05/30/04 | UPDATE DRAWING FORMAT |

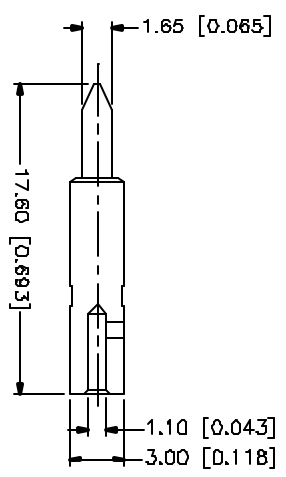
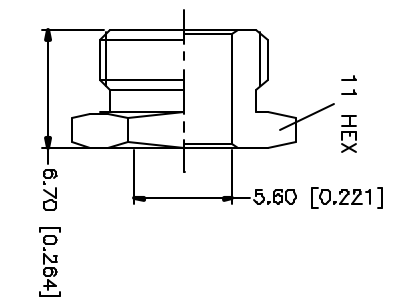
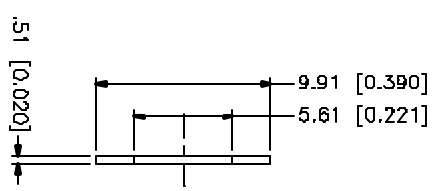
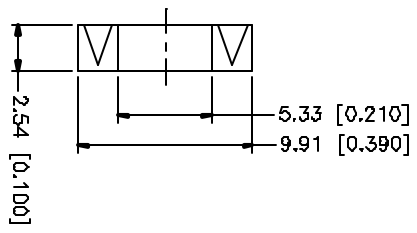
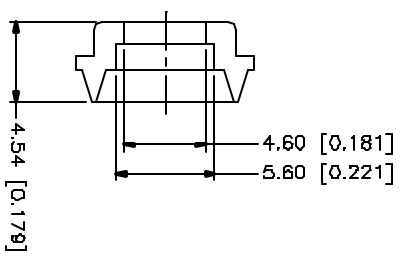
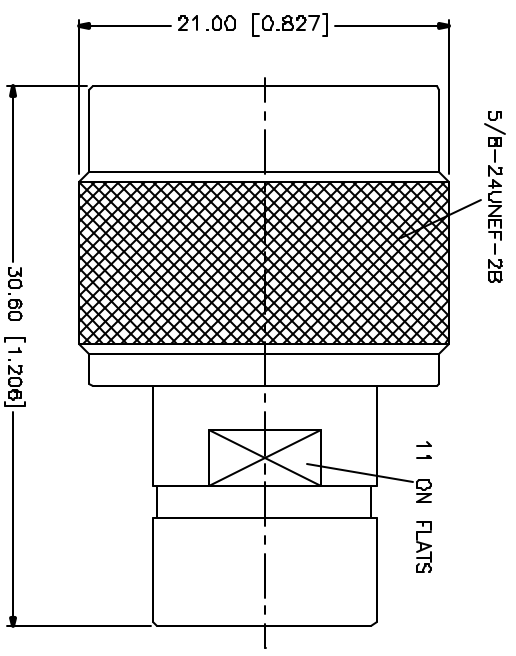
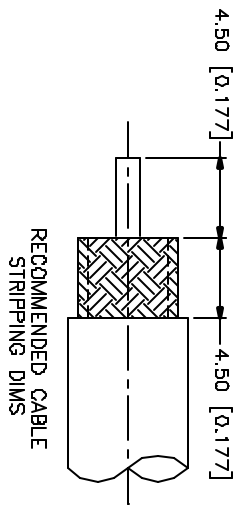

NOTE:  
1. CRIMPED CONTACT PIN\*  
HEX CRIMP SIZE .100\*  
OR SOLDER.

| QTY | FINISH  | MATERIAL | DESCRIPTION |
|-----|---------|----------|-------------|
| 1   | NEXCOTE | BRASS    | HEX NUT     |
| 1   | NEXCOTE | BRASS    | WASHER      |
| 1   | RED     | SILKZONE | GASKET      |
| 1   | NEXCOTE | BRASS    | BRAD CLAMP  |
| 1   | NATURAL | TEFLON   | INSULATOR   |
| 1   | NEXCOTE | BRASS    | BODY/SHELL  |

| APPROVALS    | DATE     | PART DESCRIPTION  |
|--------------|----------|---|
| DRAWN G.R.S. | 05/30/04 | N CLAMP PLUG<br>(FOR RG-58C/U, 58/U, 142A/U, 223/U CABLE) |
| CHECKED      |          |   |
| ISSUED       |          |   |
| SHEET 1 OF 1 |          |   |

| CU FILE           | DWG. NO.   | REV. | SIZE | SCALE |
|-------------------|------------|------|------|-------|
| C:/172/172111.DWG | 172111.DWG | B    | A    | NA    |

**Amphenol Connex**

## X-ON Electronics

Largest Supplier of Electrical and Electronic Components

*Click to view similar products for [RF Connectors / Coaxial Connectors](#) category:*

*Click to view products by [Amphenol](#) manufacturer:*

Other Similar products are found below :

[8915-1511-000](#) [89674-0827](#) [6001-7071-019](#) [6002-7051-003](#) [6002-7551-202](#) [6059674-1](#) [619550-1](#) [630059-000](#) [M39030/3-01N](#) [M3933/25-36N](#) [6500-7071-046](#) [6769](#) [CX050L2AQ](#) [7002-1542-011](#) [7004-1512-000](#) [7009-1511-004](#) [7010-1511-000](#) [7029-1511-060](#) [7101-1541-010](#) [7101-1571-002](#) [7105-1521-002](#) [7145-1521-002](#) [7203-1571-003](#) [7209-1511-011](#) [7210-1511-015](#) [7210-1511-019](#) [73137-5015](#) [73216-2241](#) [7325-1512-000](#) [73404-2300](#) [7405-1521-005](#) [7405-1521-802](#) [7406-1521-005](#) [8527](#) [8547](#) [FS11V](#) [8808-1511-001](#) [9049-9513-000](#) [9074-9513-000](#) [9101-9573-002](#) [910A205F](#) [9130-9573-002](#) [PL11SC-026](#) [PL375-33](#) [PL40-5](#) [PL71-9](#) [PL74C-221](#) [PL75MC-217](#) [PL803-7](#) [980-8666-005](#)