

REVISIONS			
REV	ECN, ERN NO.	DATE	APPRD.
A	PRODUCT DRAWING (EAR 13158)	OCT23/07	K.L.

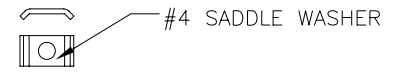

NOTES:

- 1.EACH BACKSHELL KIT CONTAINS 2 SHELL HALVES, 1 COMPRESSION INSERT TREE AND 2 OF EACH HARDWARE ITEM SHOWN.
- 2.BACKSHELL IS SUITABLE FOR SUBMINIATURE D CONNECTOR, E SIZE SHELL (9 POSITION STANDARD CONTACTS OR 15 POSITION HIGH DENSITY CONTACTS).
- 3.COMPRESSION JACKET INSERTS ARE DESIGNED FOR A CABLE DIAMETER RANGE OF .210 [5.33] TO .320 [8.13].
- 4.MATERIALS - ALL MATERIALS ARE RoHS COMPLIANT
SHELL - ZINC ALLOY, ZINC PLATED, HEXAVALENT CHROMIUM FREE FINISH.
INSERT TREE - BLACK THERMOPLASTIC, 75 DUROMETER
HARDWARE - STEEL, ZINC PLATED, HEXAVALENT CHROMIUM FREE FINISH

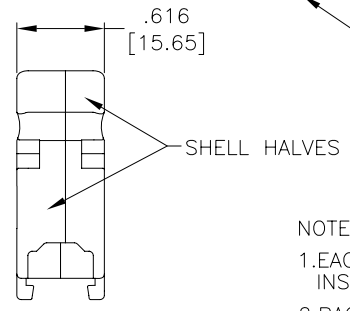
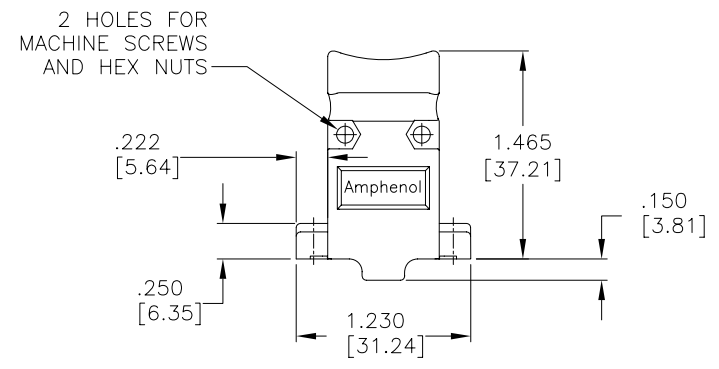
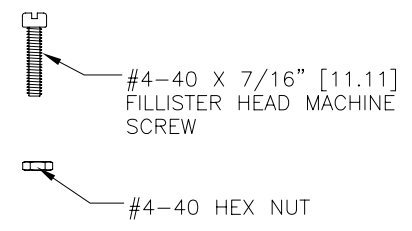
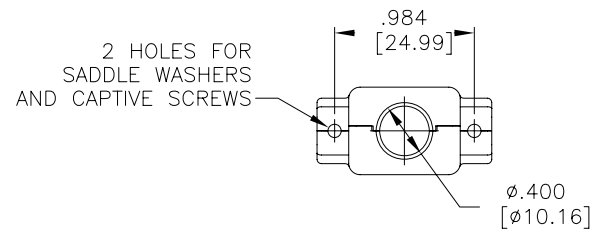
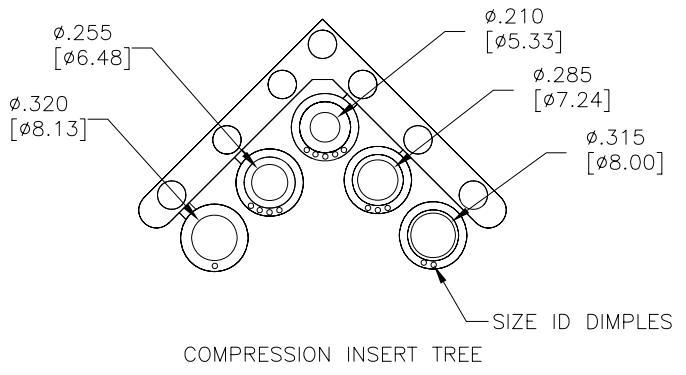

ASSEMBLY INSTRUCTIONS:

- 1.SELECT THE TIGHTEST INSERT THAT WILL FIT OVER THE CABLE, AND FEED THE CABLE THROUGH IT, PLACING THE END WITH THE SMALLER OD (THE END WITHOUT THE WASHER) TOWARDS THE CONNECTOR.
- 2.TERMINATE THE CABLE WIRES TO THE CONNECTOR.
- 3.CUT THE JACKET, FOLD THE SHIELDING BACK OVER THE OUTSIDE OF THE INSERT AND CUT IT JUST SHORT OF THE WASHER.
- 4.INSTALL SADDLE WASHERS, CAPTIVE SCREWS AND CONNECTOR.
- 5.PLACE THE WASHER IN OUTERMOST DEPRESSION IN CABLE EXIT AREA OF THE BACKSHELL AND SCREW SHELL HALVES CLOSED.

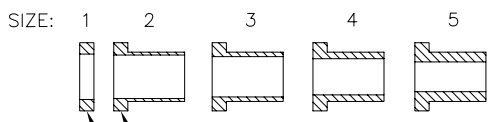

WASHER OR WASHER PORTION OF INSERT



AMPHENOL PART NUMBER 17E-1657-09

DRAWN J. WOOD		DATE SEP14/07		Amphenol Canada Corp.			
DESIGNED							
CHECKED K. LAMBIE		DATE OCT23/07		17E SERIES METAL BACKSHELL FOR D-SUB CONNECTOR WITH E SIZE SHELL (9 STD OR 15 HD CONTACTS), STRAIGHT EXIT, #4-40 THREAD, RoHS COMPLIANT			
I. E. APPRD.							
Q. A. APPRD.							
DWG. APPRD.							
ENG. REL. NO. EAR 13158		DWG. B		DRAWING NO. P-17E-1657-09		REV. A	
REF.		DIMENSIONS ARE IN INCHES [mm]		CODE ID. NO. 03554		SCALE 1.25/1	
				WT. -----		SURF. -----	
						SHEET 1 OF 1	

THIS DOCUMENT CONTAINS PROPRIETARY INFORMATION AND SUCH INFORMATION MAY NOT BE DISCLOSED TO OTHERS FOR ANY PURPOSE OR USED FOR MANUFACTURING PURPOSES WITHOUT WRITTEN PERMISSION FROM AMPHENOL CANADA CORP.

X-ON Electronics

Largest Supplier of Electrical and Electronic Components

Click to view similar products for [D-Sub Backshells](#) category:

Click to view products by [Amphenol](#) manufacturer:

Other Similar products are found below :

[600X51137X](#) [600X54009X](#) [66241-12A](#) [M85049/6-38N](#) [M85049/86-12N03](#) [M85049/90-13P03](#) [70.350.0636.4](#) [70.350.2435.1](#) [72.350.1035.2](#)
[72.352.2435.1](#) [73.359.4035.3](#) [829472-1](#) [PCS-E20W](#) [970-015-040R011](#) [971-009-030R121](#) [971-009-040R011](#) [971-015-040R011](#) [DPH-B-003](#)
[1437013-9](#) [1484402-8](#) [156-3025-EX](#) [16-500800](#) [165X02659X](#) [165X03399A](#) [165X10259X](#) [165X11359X](#) [165X11689X](#) [165X11759X](#)
[165X11889X](#) [165X11899X](#) [165X13019X](#) [165X13029X](#) [165X13169X](#) [165X13199X](#) [165X13239X](#) [165X13389X](#) [165X13489X](#)
[165X14219X](#) [165X14429X](#) [165X14449X](#) [165X17409X](#) [165X17439X](#) [165X17569X](#) [165X17599X](#) [165X17609X](#) [165X17979X](#) [L171373](#)
[971-025-030R121](#) [300X10989X](#) [165X02609X](#)