

# μCom-10Gb +

Harsh Environment 10Gb  
Ethernet Micro Connectors



μCom-Series is a new range of connectors designed to address the latest trends of the industry : **miniaturization** and **high speed**, with the highest resistance for use in the **harshest environments**.

## MAIN FEATURES

- 10Gb+: exceeds 10Gb/s Ethernet following IEEE 802.3an-2006 : **10GBase-T**
- Cat.6A connector according to TIA568C.2 and ISO/IEC11801 standard
- Environmental testing based on **MIL-DTL-38999 series III** military specifications (Thread version)
- Environmental testing based on **MIL-DTL-26482** military specifications (Push Pull version)
- Miniature : **15 mm(.59") max** external diameter
- Receptacle and in-line receptacle compatible with both thread and Push Pull plugs

## FEATURES AND BENEFITS

- 4 pairs totally insulated throughout the connector
  - ➔ minimum cross-talk between the four pairs
- Patented special interfacial shapes
  - ➔ minimum perturbation at the interface of each pair
- Thread and Push Pull coupling mechanisms
  - ➔ 2000 mating cycles & high vibration resistance
- Machined Brass shells
  - ➔ Plating available:
    - Olive Drab Cadmium → not ROHS compliant
    - Black Nickel, and unplated brass → ROHS compliant
  - ➔ shell to shell continuity and 500h salt spray resistance
- Machined & gold plated Solder and Crimp contacts
  - ➔ design & performance according to the innercontact of M39029/77-429#16 M39029/76-425#16 38999 contact
  - ➔ contacts are crimped with standard crimping tool M22520/2-01 + Amphenol μCom positioner
- Solder contact : max AWG24
- Crimp contact : AWG 24 to 28
- IP68 sealing mated and unmated for PCB receptacles
- 1500 Vrms Dielectric Withstanding Voltage
- Temperature range : - 55°C / + 125°C

## MARKETS & APPLICATIONS

- **MILITARY:** C4ISR, Battlefield Communications, Shipboard, Ground Vehicles Vetronics.
- **AEROSPACE :** In Flight Entertainment\*, Avionics\*, Communication Systems.

\*μCom approved by GORE



TRANSMISSION DATA

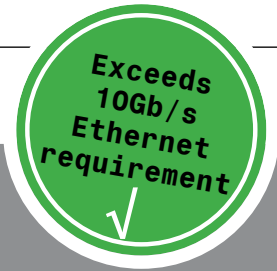

Insertion Loss (IL) :

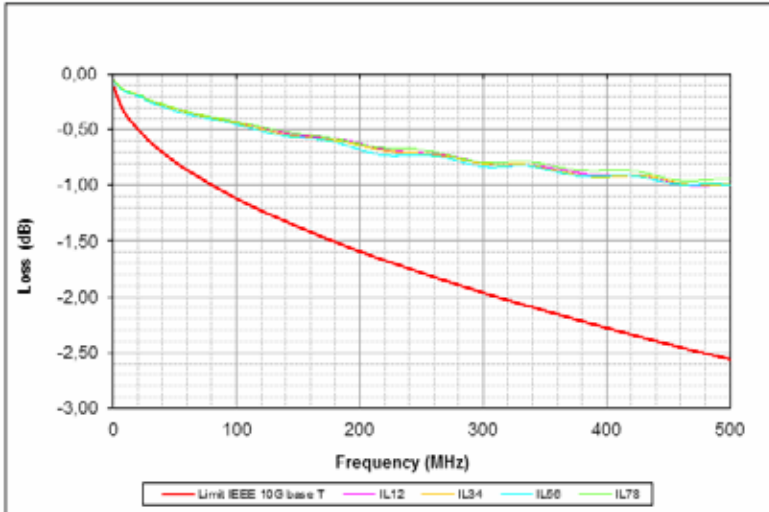

← Amphenol performance

← IEEE 802.3an Standard requirement

Near End crosstalk (NEXT) :

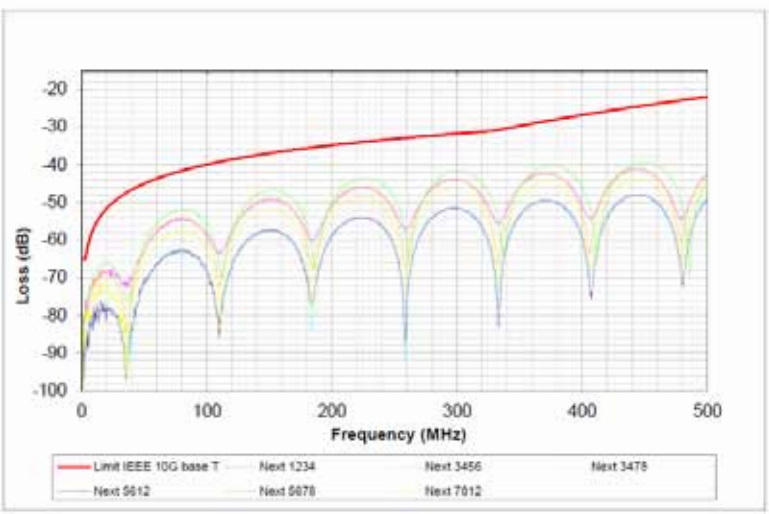

← IEEE 802.3an Standard requirement

← Amphenol performance

Return Loss (RL) :

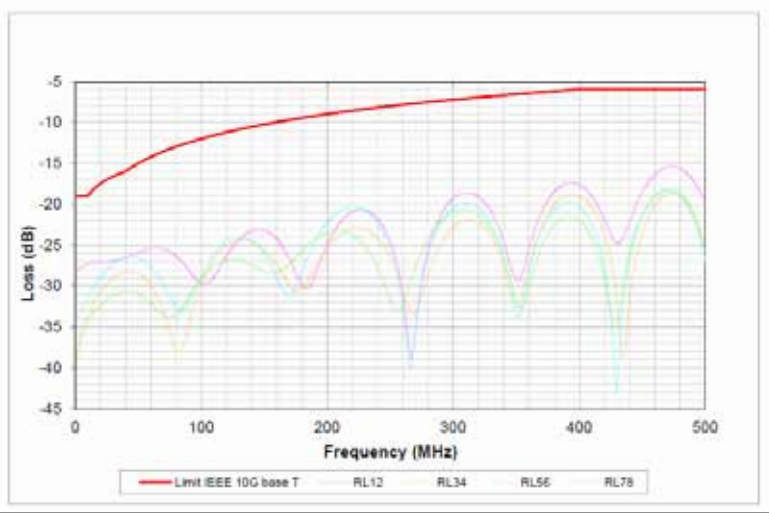

← IEEE 802.3an Standard requirement

← Amphenol performance

FEMALE RECEPTACLES



**Female receptacle for printed circuit board**

Compatible with both thread & push pull plugs

Part number: UCOM-10G+ R P X

X: see the 'How to order' below to complete your part number

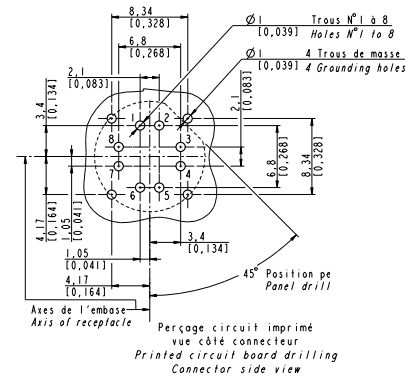
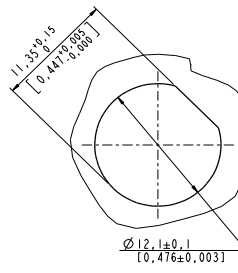
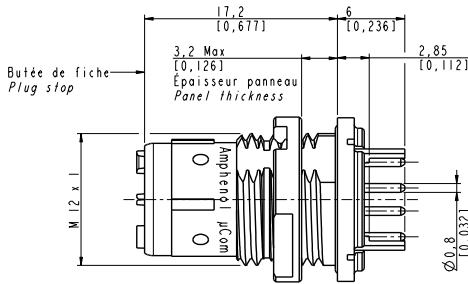

**Panel mount female receptacle with metallic band backshell**

Compatible with both thread & push pull plugs

Part number: UCOM-10G+ R X X

X: see the 'How to order' below to complete your part number

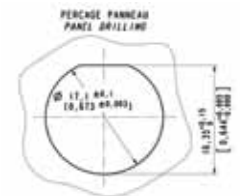
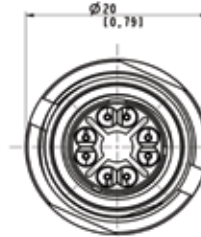
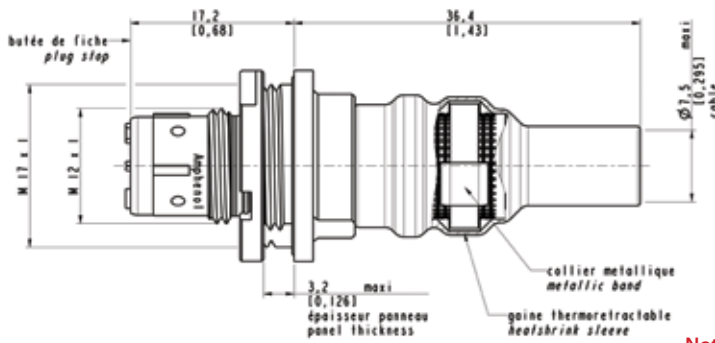

Nota: metallic band and heatshrink sleeve are provided with the connector

HOW TO ORDER Female receptacles

UCOM - 10G+ R P B

**Shell**

R: receptacle (push pull or thread)

**Contacts termination**

P: PCB

S: solder

C: crimp

**Shell plating**

B: black nickel

G: olive drab cadmium

U: unplated brass

**NOTA:**

- UCOM for order designation
- µCom for marking on connectors

MALE PLUGS



Plug with cable gland backshell

Part number: UCOM-10G+ P T x x G x  
 x: see the 'How to order' below to complete your part number

Part number: UCOM-10G+ P P x x G x  
 x: see the 'How to order' below to complete your part number

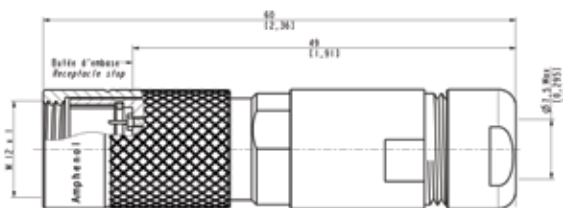

Thread version

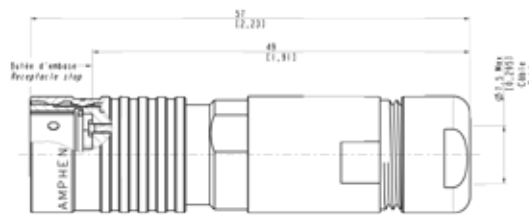
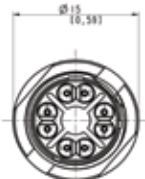

Push Pull version



Plug with metallic band backshell

Part number: UCOM-10G+ P T x x B  
 x: see the 'How to order' below to complete your part number

Part number: UCOM-10G+ P P x x B  
 x: see the 'How to order' below to complete your part number

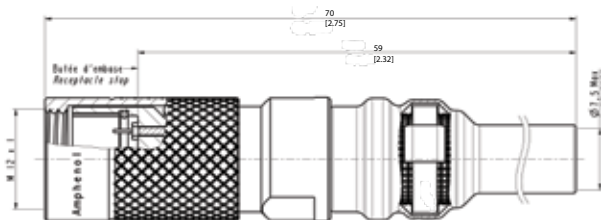

Thread version

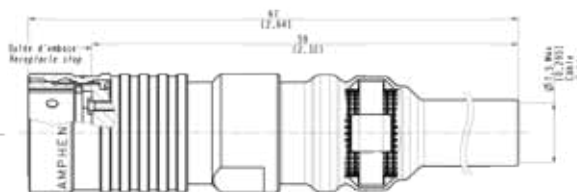
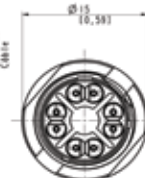

Push Pull version

**Nota:** Metallic band and heatshrink sleeve are provided with the connector

HOW TO ORDER Male plugs

	UCOM - 10G+	P	T	C	B	G	A
<b>Shell</b> P: plug							
<b>Mating (for plugs only)</b> T: thread P: push-pull							
<b>Contacts termination</b> C: crimp S: solder							
<b>Shell plating</b> B: black nickel G: olive drab cadmium U: unplated brass							
<b>Backshell type</b> G: gland B: band							
<b>Cable diameter (for gland backshell only)</b> A: for cable diam 7.5mm							

**NOTA:**

- UCOM for order designation
- μCom for marking on connectors

For other cable diameter, please consult us

FEMALE IN-LINE RECEPTACLES

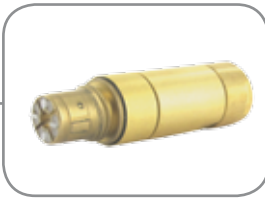

**Female in-line receptacle with cable gland backshell**

Compatible with both thread & push pull plugs

Part number: UCOM-10G+ L x x G x  
 x: see the 'How to order' below to complete your part number

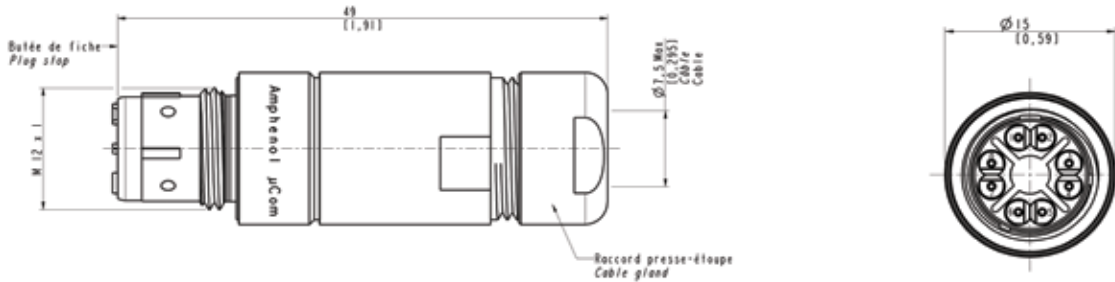

**Female in-line receptacle with metallic band backshell**

Compatible with both thread & push pull plugs

Part number: UCOM-10G+ L x x B  
 x: see the 'How to order' below to complete your part number

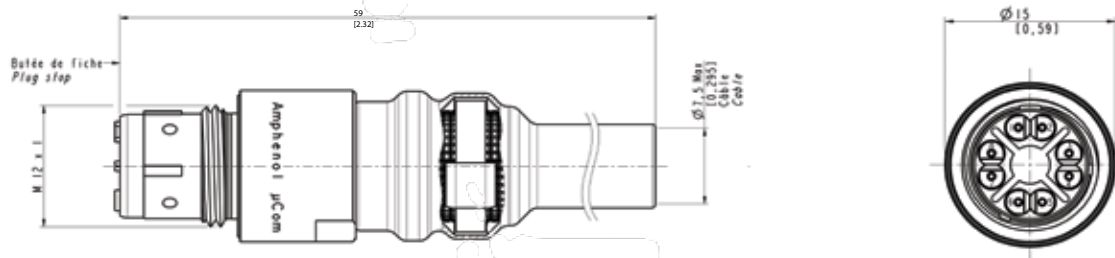

**Nota:** Metallic band and heatshrink sleeve are provided with the connector

HOW TO ORDER Female in-line receptacles

UCOM - 10G+	L	S	B	G	A
<b>Shell</b>					
L: in line receptacle (push pull or thread)					
<b>Contacts termination</b>					
C: crimp					
S: solder					
<b>Shell plating</b>					
B: black nickel					
G: olive drab cadmium					
U: unplated brass					
<b>Backshell type</b>					
G: gland					
B: band					
<b>Cable diameter (for gland backshell only)</b>					
A: for cable diam 7.5mm					

- NOTA:**
- UCOM for order designation
  - μCom for marking on connectors

For other cable diameter, please consult us

CORDSETS



New cabling configuration		
Cable number		Connector number
1	White / Orange	1
2	Orange	2
3	White / green	3
6	Green	4
5	White / Blue	5
4	Blue	6
7	White / Brown	7
8	Brown	8

μCom plug - μCom plug cordset

Part number:  
UCOM-10G+ C x x x xxx

x: see the 'How to order' on the next page to complete your part number

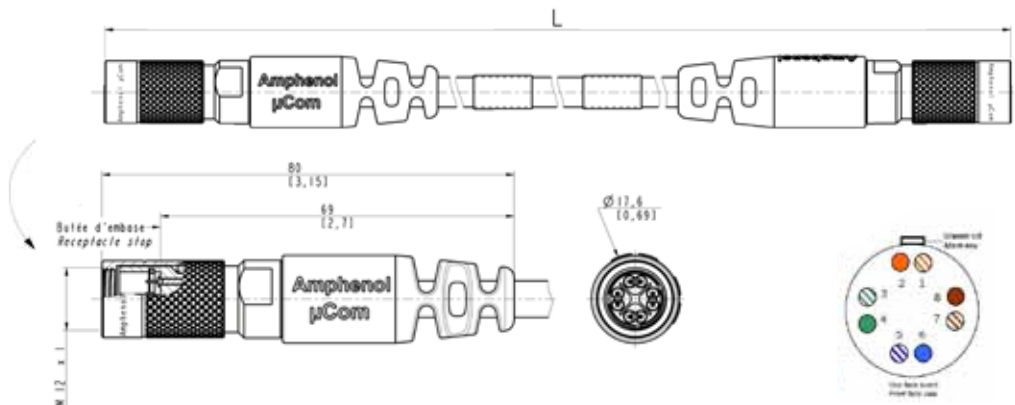

μCom plug - RJ45 Cat6A plug cordset

Part number:  
UCOM-10G+ D x x x xxx

x: see the 'How to order' on the next page to complete your part number

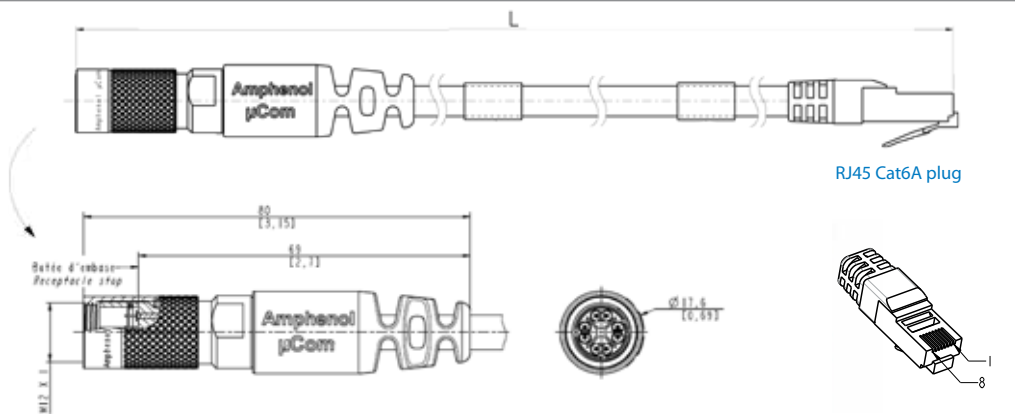

μCom panel mount receptacle - RJ45 Cat6A plug

Part number:  
UCOM-10G+ E x x x xxx

x: see the 'How to order' on the next page to complete your part number

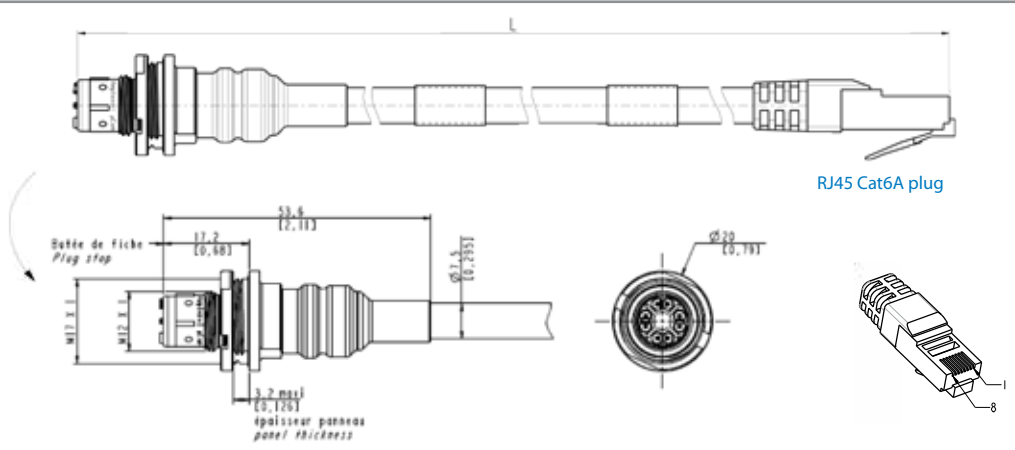

μCom plug - μCom inline receptacle

Part number:

UCOM-10G+ F x x x xxx

x: see the 'How to order' below to complete your part number

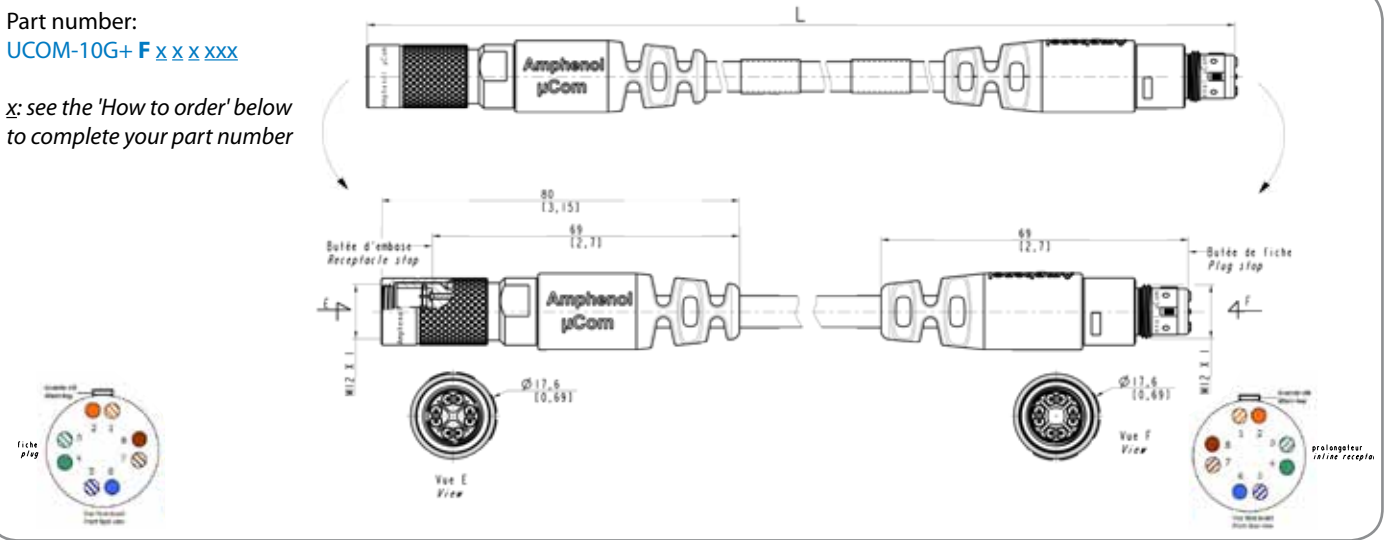

Type of cable used: CAT 7 HFFR - According to EN 50288-4-2



- Stranded bare copper wire (26 AWG)
- 4 screened twisted pairs: 2 wires twisted to a pair, Alulamine foil overlapped
- Shield braiding of tinned copper wires, about 80% coverage
- Strain member of Kevlar
- Jacket in black Polyurethane (PUR), glossy finish, acc to DIN VDE 0282
- External diameter 7.0 +/-0.3 mm
- UV & Hydrolysis resistant, Halogen free, RoHS compliant
- Max Pull force: 800 N, Weight : about 54 kg/km
- Temperature : - 40°C / + 85°C
- Min. bending radius allowed: repeated 8 x Ø, single 4 x Ø

GORE® has approved μCom assembled onto their cat6A cable P/N : RCN9034-24. Information available on GORE® website.

HOW TO ORDER Cordsets

UCOM - 10G+ C T C B 015

Shell

- C: μCom plug - μCom plug cordset
  - D: μCom plug - RJ45 Cat6A plug cordset
  - E: μCom panel mount receptacle - RJ45 Cat6A plug cordset
  - F: μCom plug - μCom inline receptacle cordset
- Open versions:
- G: μCom plug - no connector at the end
  - H: μCom panel mount receptacle - no connector at the end
  - J: μCom inline receptacle - no connector at the end

Mating (for plugs only)

T: thread

Contacts termination

- C: crimp
- S: solder

Shell plating

- B: black nickel
- G: olive drab cadmium
- U: unplated brass

Total length - For other lengths, please consult us.

- 002: 20 cm [7.87]
- 005: 50 cm [19.68]
- 010: 1.0 m [39.37]
- 015: 1.5 m [59.05]
- 020: 2.0 m [78.74]
- 050: 5.0 m [196.85]
- 100: 10.0 m [393.70]

NOTA:

- UCOM for order designation
- μCom for marking on connectors

ACCESSORIES

CAPS for receptacles

IP68 metallic cap

**X** to be replaced by  
**B** for Black electrophoresis plating  
**G** for Olive drab cadmium plating  
**U** for Unplated brass

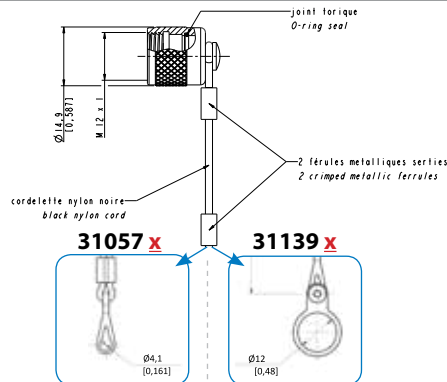

IP68 metallic cap with metallic tie on panel Or IP68 metallic cap with a Ø12 fixation ring  
 Nota: plan a hole on the panel

IP68 neoprene cap - Part number: **31091**  
 Nota: plan a type M3 hole on the panel



CAPS for plugs

Cap in neoprene  
 Part number: **31092**



CAPS for in line receptacles

Cap in neoprene  
 Part number: **31093**



Dummy female receptacle

Part number: **31131 X**

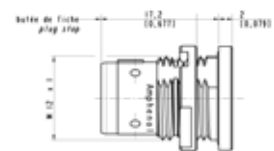

**X** to be replaced by  
**B** for Black nickel plating  
**G** for Olive drab cadmium plating  
**U** for Unplated brass

SPARES

Crimp Pin  
 Part number: **31073**



Crimp Socket  
 Part number: **31074**



TOOLS



- Nut clamping tool for receptacle  
 Part number: **31055**  
 Only for RPx receptacles



- Insertion tool for crimp contacts  
 Part number: **31056**



- Contact positioner for M22520/2-01 crimping tool  
 Part number: **31095**

Other tools:

- Brazing tool for receptacle & in-line receptacle  
 Part number: **31132**
- Brazing tool for plug  
 Part number: **31133**

Nota: the cabling instructions are available upon demand (ref. N00-040190-00).



## X-ON Electronics

Largest Supplier of Electrical and Electronic Components

*Click to view similar products for [Modular Connectors](#) / [Ethernet Connectors](#) category:*

*Click to view products by [Amphenol](#) manufacturer:*

Other Similar products are found below :

[8949-H88/06BLKA/SN](#) [74441-0010/BKN](#) [MP1010RX-1000](#) [MP44RX-1000](#) [PHJ-4P4C-1-V-4](#) [PHP-6P6C-5](#) [GAX-3-66](#) [GAX-8-62](#) [GDCX-PA-66-50](#) [GDCX-PN-64](#) [GDCX-PN-66](#) [GDCX-PN-66-50](#) [GDLX-A-66](#) [GDLX-N-66](#) [GDLX-S-66](#) [GDLX-S-88K](#) [GDTX-S-88-50](#) [GDX-PA-1010](#) [GLX-N-1010M-BLK](#) [GLX-S-88M-BLK](#) [GMX-N-1010](#) [GMX-S-1010](#) [GMX-S-66](#) [GMX-SMT4-N-88](#) [GPX-2-64](#) [GSGX-N-2-88](#) [GSGX-N-4-88](#) [GSX-NS2-88-3.05](#) [GSX-NS2-88-3.05-50](#) [GSX-NS-88-3.68](#) [PT-108A-8C-UL](#) [PT-J951-8C](#) [PTS-J531-8CS-50UL](#) [1-1775629-2](#) [A-2014-0-4](#) [GWLX-S-88-GR](#) [GWLX-S9-88-YG](#) [DC-1021-8-WH-6](#) [1300530003](#) [1324640-4](#) [RJ11FTVC2G](#) [RJ11FTVC2N](#) [RJFTVX2SA1G](#) [132764-001](#) [1413235](#) [MP88X-1000](#) [MPS88RX-5000](#) [MRJR-5481-0F2](#) [E5288-S000K3-L](#) [E5908-15A242-L](#)