

NOTES:

1. MATERIALS AND FINISHES(PLATING THICKNESS IN MICRO-INCHES):
 BODY - BRASS, NICKEL PLATING
 CONTACT - BRASS, SILVER PLATING
 INSULATOR - PTFE, NATURAL
2. ELECTRICAL:
 A. IMPEDANCE: 50 OHM
 B. FREQUENCY RANGE: DC 0-4 GHz
 C. DIELECTRIC WITHSTANDING VOLTAGE: 1500 VRMS, MIN.
3. MECHANICAL:
 A. DURABILITY: 500 CYCLES MIN.
 B. TEMPERATURE RANGE: - 65°C to +165°C

THIRD ANGLE PROJ.

REVISIONS

REV	DESCRIPTION	DATE	ECO	APPR
B	SEE SHEET 1	17-Oct-06	--	AW
C	SEE SHEET 1	06-Mar-08	--	AW
AA	SEE SHEET 1	18-Dec-09	47888	SH
AB	STAMP "AMPHENOL" WAS "74868"\RD-DM11120601R3	26-Dec-11	48843	SH

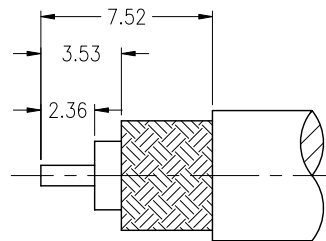

RECOMMENDED
CABLE STRIPPING DIM'S

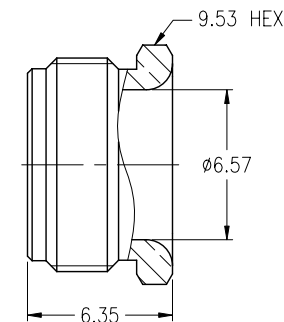
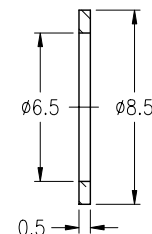
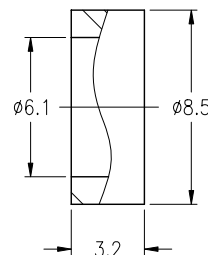
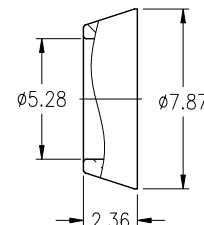
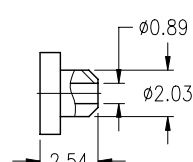
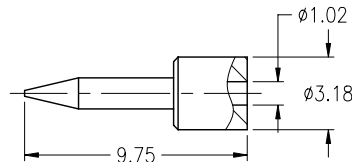
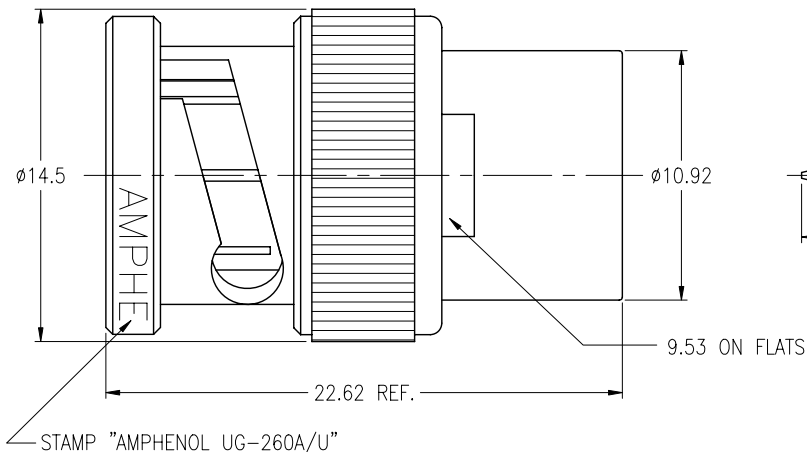

CUSTOMER OUTLINE DRAWING
ALL OTHER SHEETS ARE FOR INTERNAL USE ONLY

UNLESS OTHERWISE SPECIFIED, DIMENSIONS ARE IN METRIC AND TOLERANCES ARE:
 <0.5mm ±0.05mm 0.5 - 6mm ±0.1mm 6 - 30mm ±0.2mm 30 - 120mm ±0.3mm ANGLES ±1°

NOTICE - These drawings, specifications, or other data (1) are, and remain the property of Amphenol Corp. (2) must be returned upon request; and (3) are confidential and not to be disclosed to any person other than those to whom they are given by Amphenol Corp. The furnishing of these drawings, specifications, or other data by Amphenol Corp., or to any other person to anyone for any purpose is not to be regarded by implication or otherwise in any manner licensing, granting rights or permitting such holder or any other person to manufacture, use or sell any product, process or design, patented or otherwise, that may in any way be related to or disclosed by said drawings, specifications, or other data.

MATERIAL	DRAWN R.MAO	DATE 12-Dec-11	TITLE BNC CLAMP PLUG (FOR UG-260A/U)			Amphenol RF Danbury CT USA, Tainan Taiwan, Shenzhen China www.amphenolrf.com	
REFERENCE	ENGINEER C.WANG	DATE 16-Dec-09	SCALE: 3/1	SHEET 2 OF 2	DRAWING NO. 31-21		
FINISH	APPROVED S.HSIEH	DATE 12-Dec-11			DWG SIZE B	CODE ID 74868	REV AB
	F:\DWG\CNPD\31\21-ABSZ					PART NO. 31-21	

X-ON Electronics

Largest Supplier of Electrical and Electronic Components

Click to view similar products for [RF Connectors / Coaxial Connectors](#) category:

Click to view products by [Amphenol](#) manufacturer:

Other Similar products are found below :

[8915-1511-000](#) [89674-0827](#) [6001-7071-019](#) [6002-7051-003](#) [6002-7551-202](#) [6059674-1](#) [619550-1](#) [630059-000](#) [M39030/3-01N](#) [M3933/25-36N](#) [6500-7071-046](#) [6769](#) [CX050L2AQ](#) [7002-1542-011](#) [7004-1512-000](#) [7009-1511-004](#) [7010-1511-000](#) [7029-1511-060](#) [7101-1541-010](#) [7101-1571-002](#) [7105-1521-002](#) [7145-1521-002](#) [7203-1571-003](#) [7209-1511-011](#) [7210-1511-015](#) [7210-1511-019](#) [73137-5015](#) [73216-2241](#) [7325-1512-000](#) [73404-2300](#) [7405-1521-005](#) [7405-1521-802](#) [7406-1521-005](#) [8527](#) [8547](#) [FS11V](#) [8808-1511-001](#) [9049-9513-000](#) [9074-9513-000](#) [9101-9573-002](#) [910A205F](#) [9130-9573-002](#) [PL11SC-026](#) [PL375-33](#) [PL40-5](#) [PL71-9](#) [PL74C-221](#) [PL75MC-217](#) [PL803-7](#) [980-8666-005](#)