

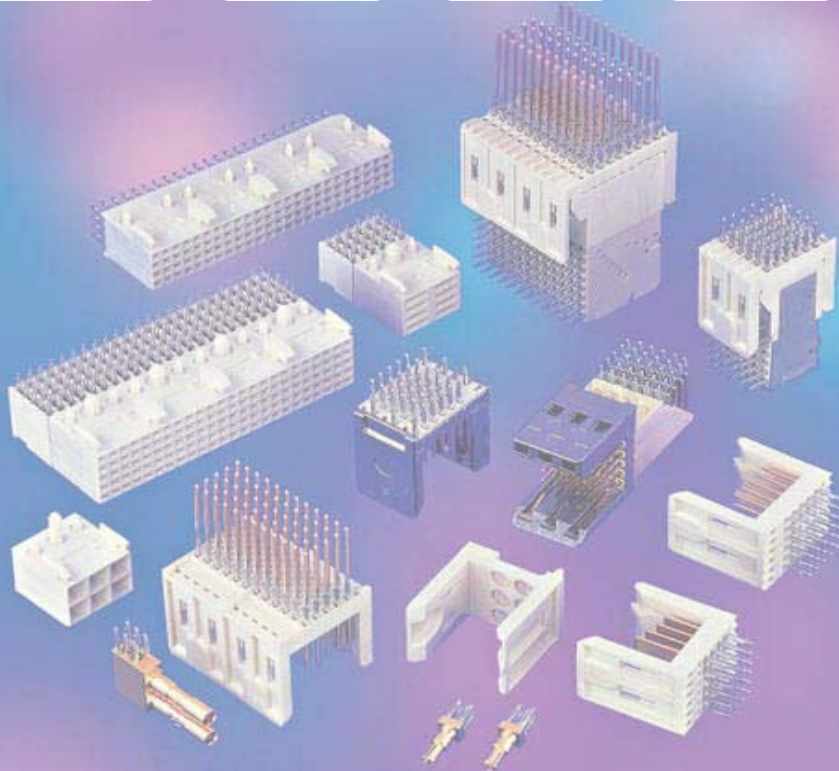

APPLICATIONS & SPECIFICATIONS



 ELECTRONICS

METRAL[®]

2 mm Modular Interconnect System

METRAL® 4 row assemblies

UNMATED

MATED

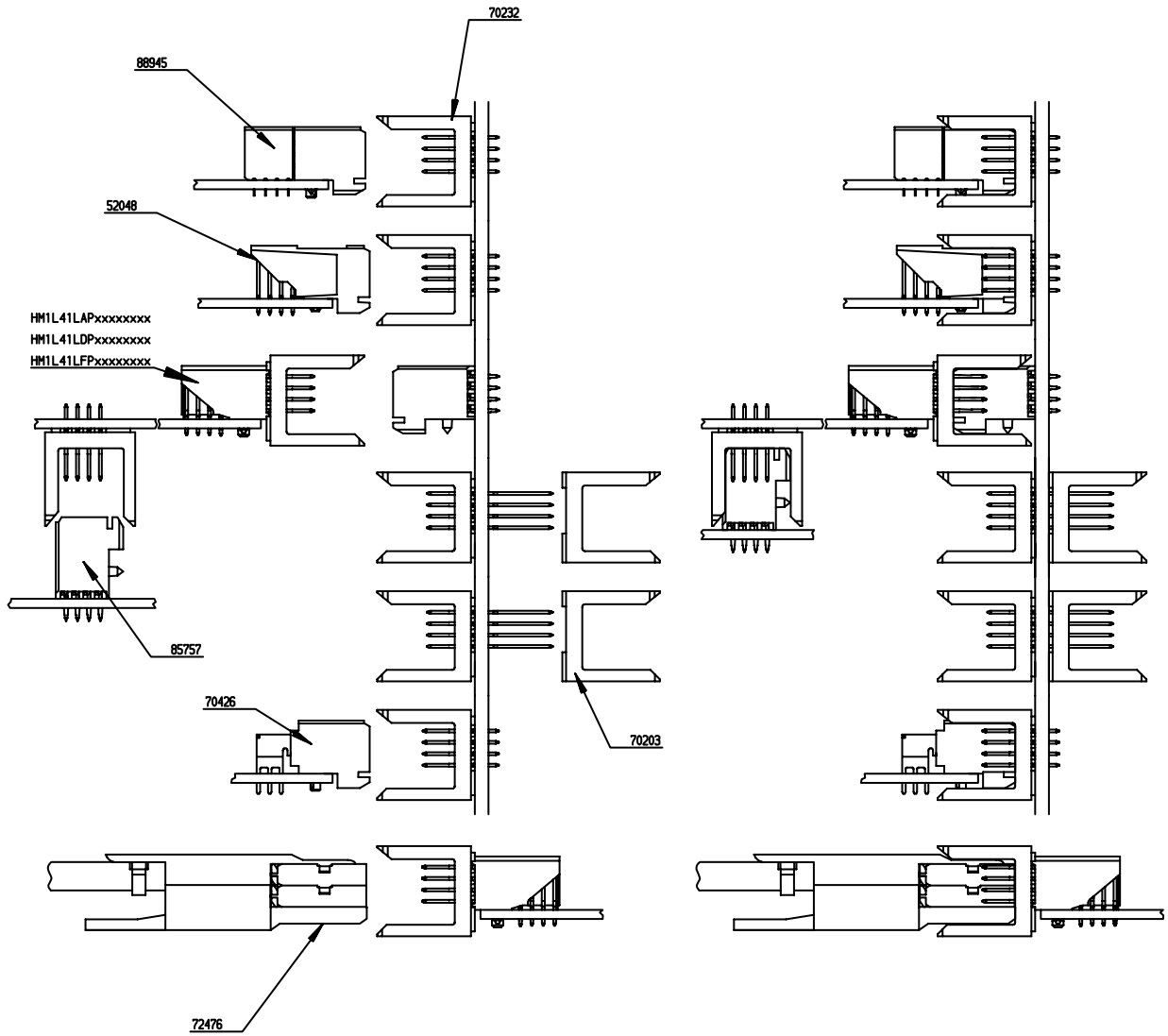

METRAL® 5 row assemblies

UNMATED

MATED

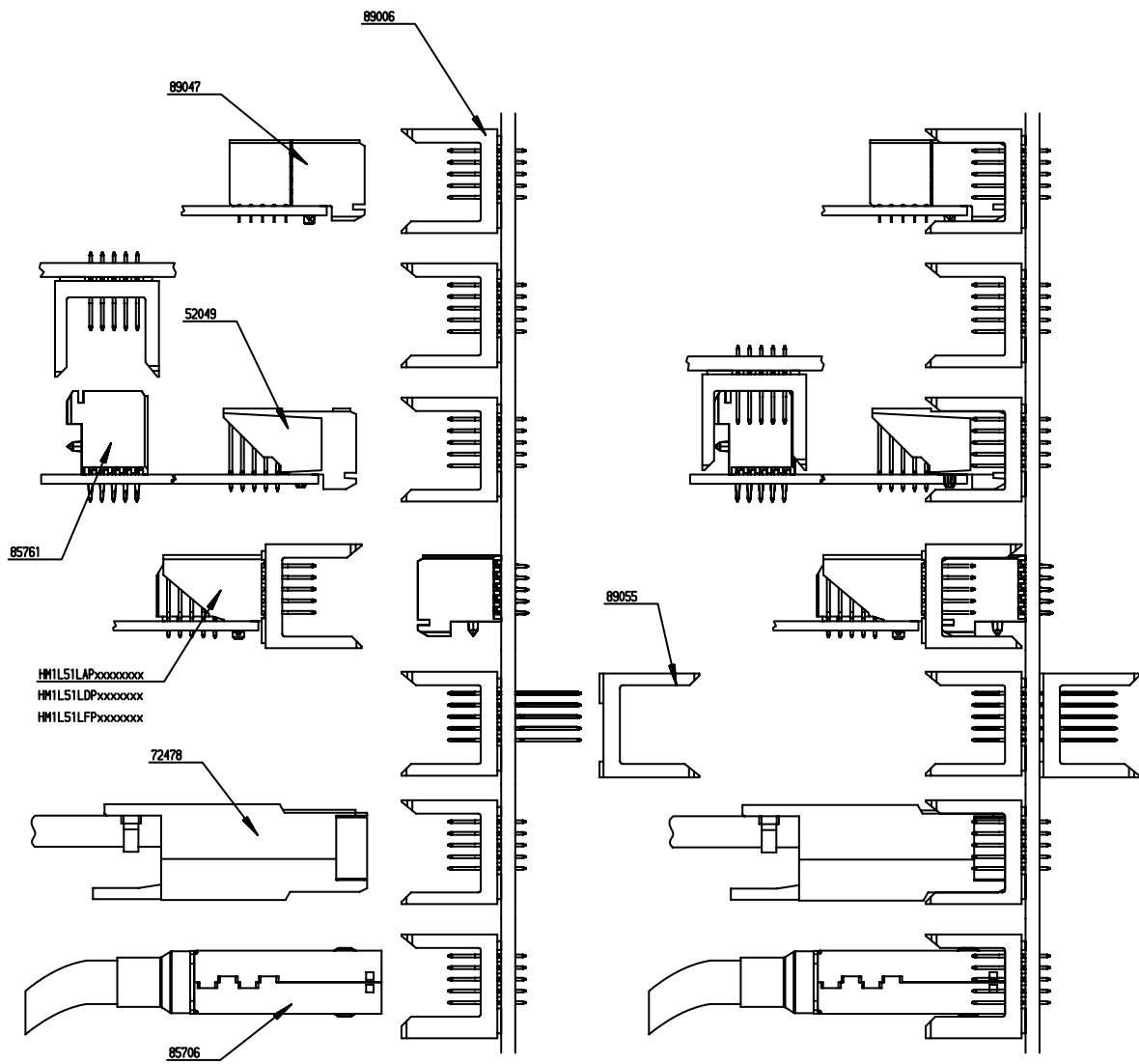

METRAL® 8 row assemblies

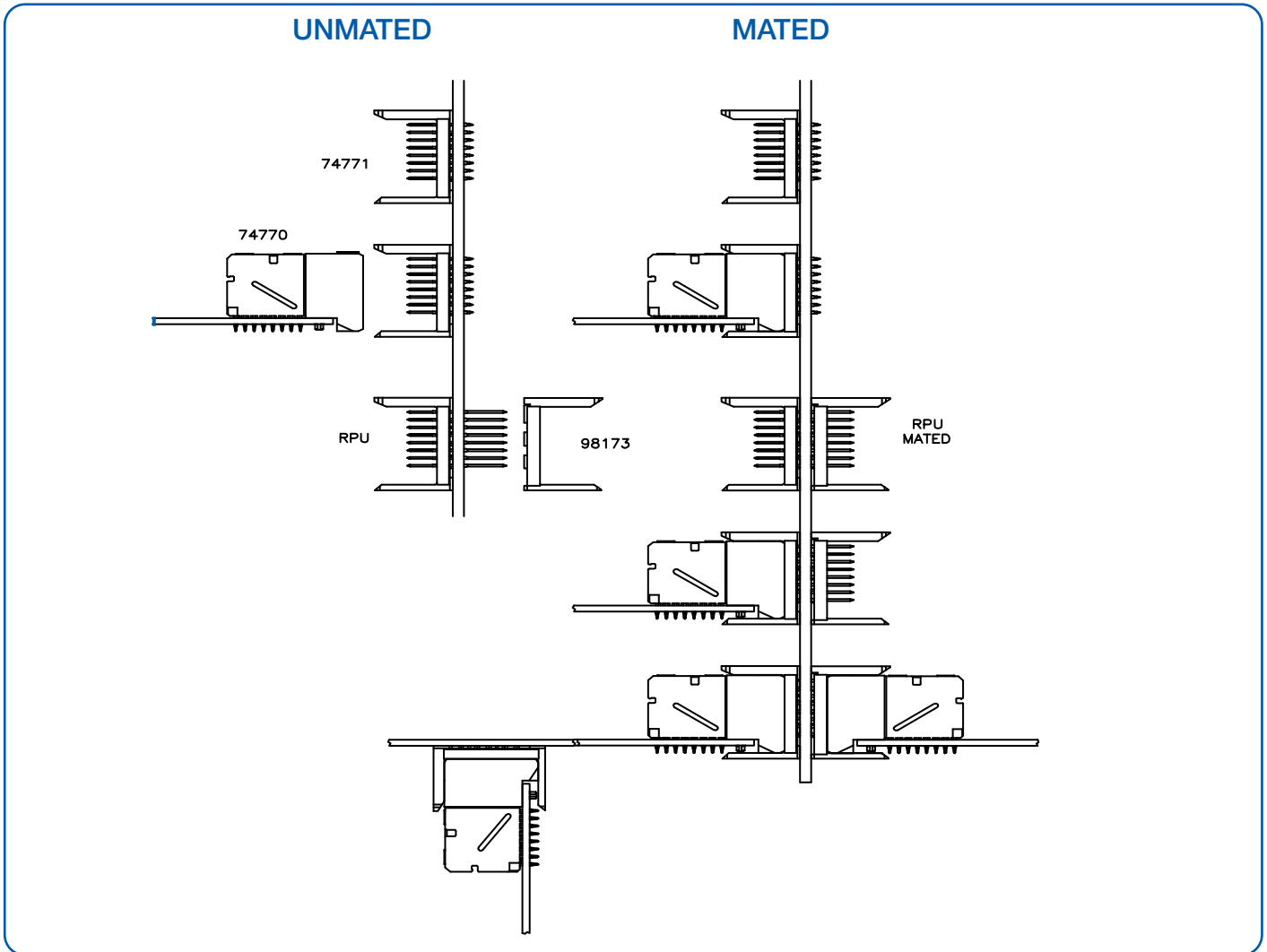

METRAL® DIN High Power assemblies

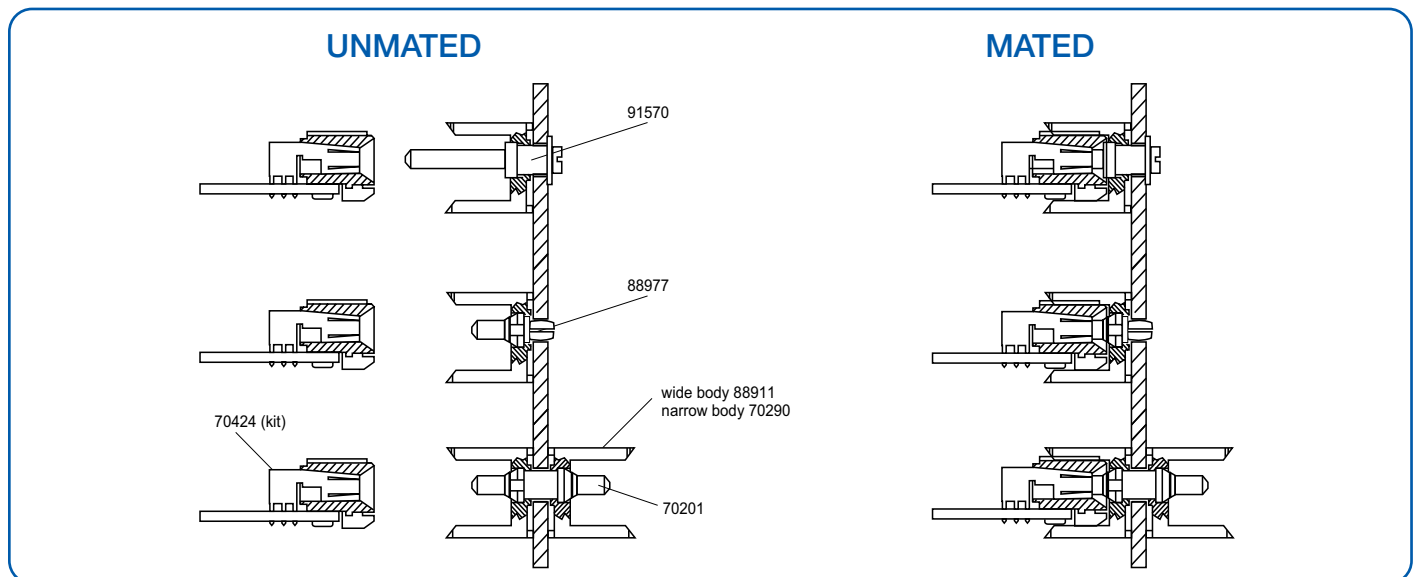

METRAL® DIN standard Coax assemblies

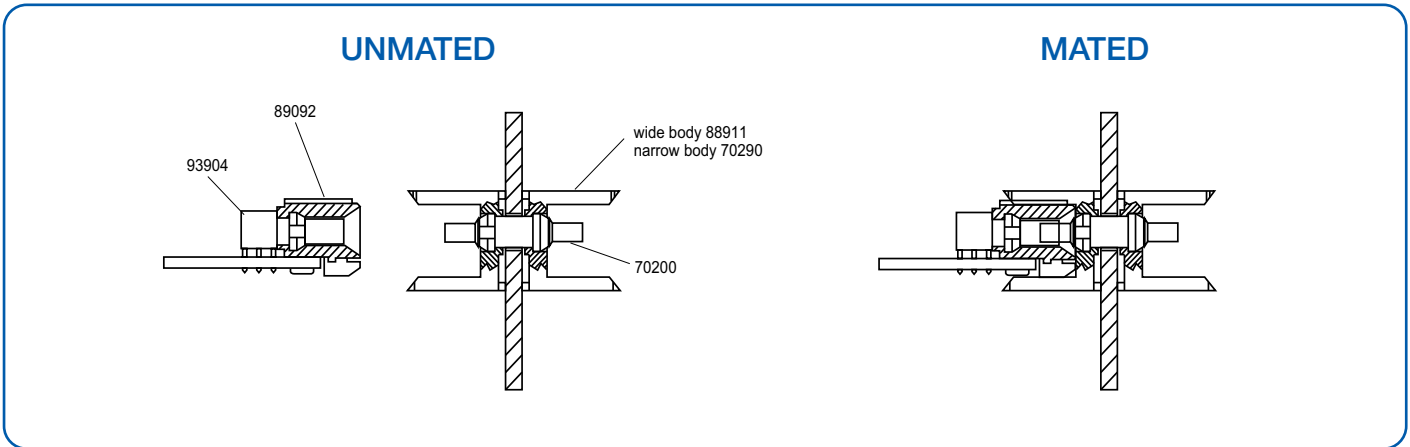

METRAL® Mini Power assemblies

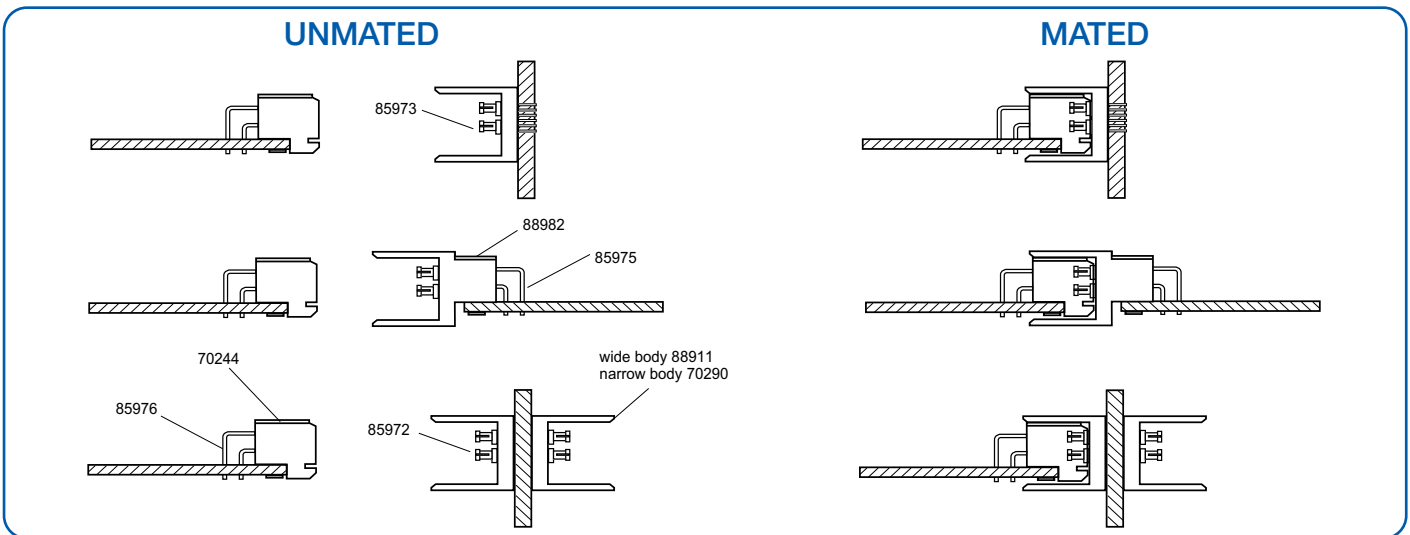



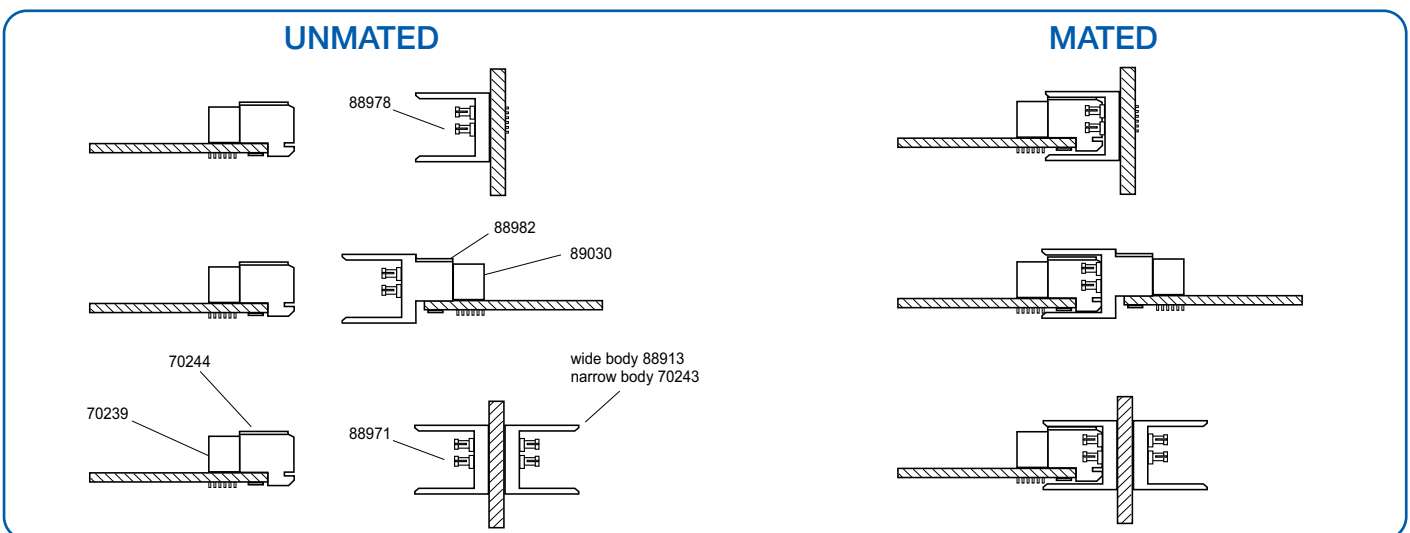

METRAL® Mini Coax assemblies

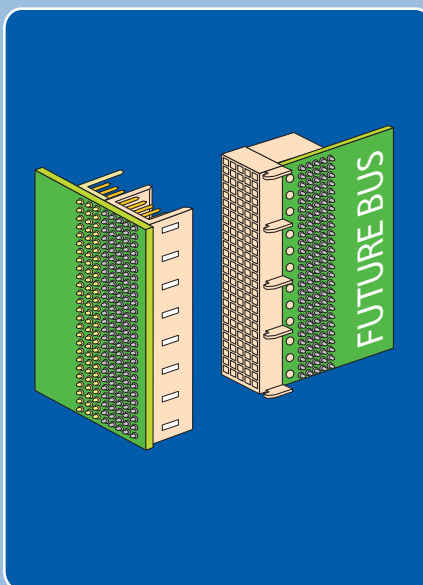





METRAL® TECHNICAL SPECIFICATION

-  Future Bus
-  IPCI Bus
-  Performance Specifications
-  Electrical Specifications
-  Process Specifications

METRAL® FUTUREBUS versus HARD METRIC

FUTUREBUS

- ▶ METRAL® Core
- ▶ METRAL® High Speed

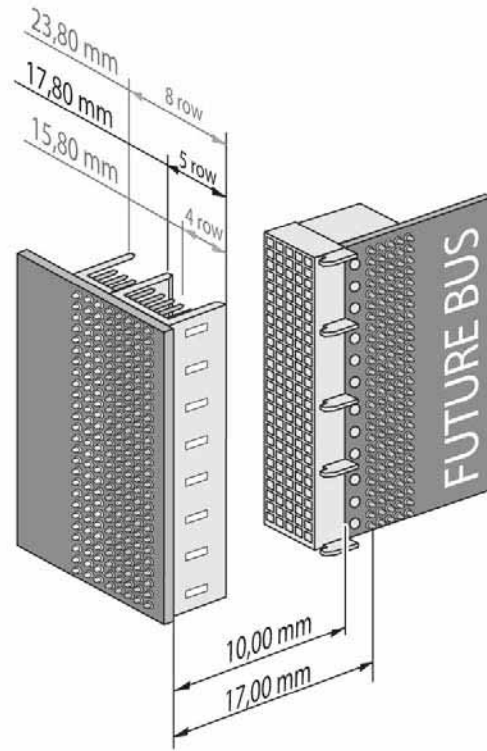

HARD METRIC

- ▶ Millipacs
- ▶ Airmax

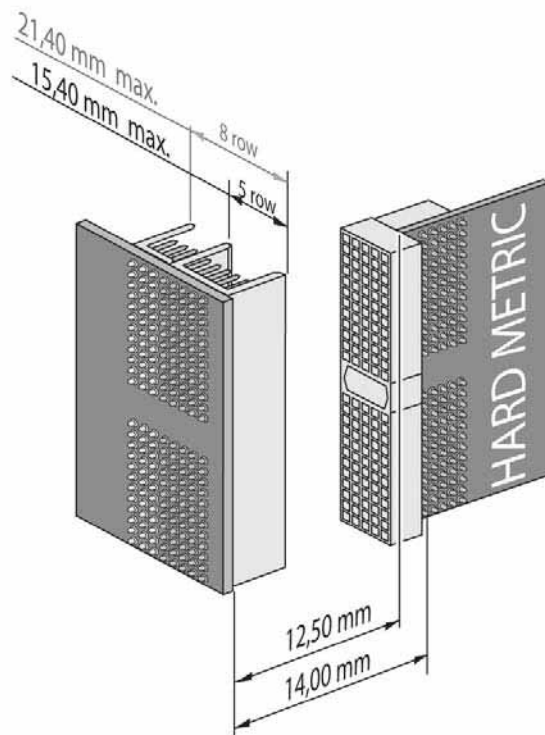

METRAL® IPCI Bus

FCI Electronics

METRAL® connector system was chosen as the interconnection system for the IPCI (Industrial peripheral computer Interface)

The following are typical 3SU and 6SU board configurations

Daughter Board Receptacle Right-Angle

- Solder-to-Board
5 x 48 positions
85866-xxxLF
- Press-Fit
5 x 48 positions
89055-xxxLF

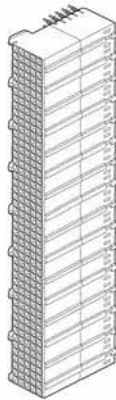

Backpanel Header Straight

- Press-Fit
5 x 48 positions
89009-xxxLF

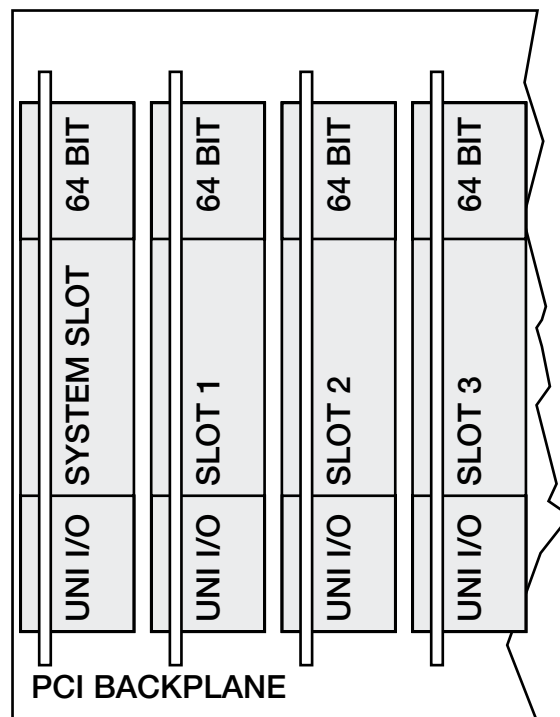
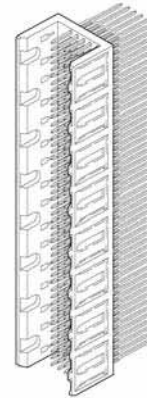

ELECTRICAL CHARACTERISTICS

GENERAL

- Although some of these parameters can be obtained from tabulated measured data, they are typically obtained from tabulated measured data, they are typically obtained from finite element or boundary element modeling type programs which model portions of the connector as separate transmission line sections. The resulting R, L, and C matrices are converted to SPICE parameters for each transmission line section. These parameters basically define lumped element approximations to each transmission line section. The METRAL® connector can be represented by three such transmission line sections; one for the leaded section, one for the internal block section, and one for the header section.
- The METRAL™ connector has been modeled by FCI Electronics, Ind. using Quantic Laboratories' two dimensional boundary element modeling program called Greenfield®.
- FCI Electronics has a number of SPICE models available.
- METRAL® 4 row 7 : 1 and 2 : 1 signal/ground ratio
- METRAL® 5 row 2 : 1 and 4 : 1 signal/ground ratio
- METRAL® 5 row row C grounded

Of course if needed, a specific SPICE model can be generated (ask for details)

Summary METRAL™ electrical data Standard

- All data :** With 2 : 1 signal to ground ratio
Measurement system 50 Ohm impedance
- Capacitance**
(1 mHz)
(mated connector) 1 - 1,25 pF max.
(location dependent)
- Inductance**
500 ps risetime 12 - 18 nH
1000 ps risetime 15 - 24 nH
(location dependent)
- Propagation delay** 143 - 214 ps
(24 ps. row to skew)
- Crosstalk** (single line driven)
500 ps risetime 6,0 % max. near end
1000 ps risetime 3,5 % max. near end
- Impedance**
1000 ps risetime 56 - 71 Ohm
(location dependent)
- Contact resistance**
signal 25 - 45 m Ohm
power 8 m Ohm
- Insulation resistance** > 5000 M Ohm

ELECTRICAL CHARACTERISTICS

GENERAL

Current Carrying Capacity.

The current carrying capacity of a connector is that current which elevates the contact temperature to a specified value. It is a function of many variables including interconnection wiring (open wires and/or printed wiring), gauge and/or cross sections of wiring, board thicknesses, current in adjacent contacts, ambient temperature, and air flow.

Since actual application details may differ from these experimental conditions, the following results are provided only as an approximate guide for the current carrying capacity of the METRAL® Modular System. Current carrying capacity was measured for 10°C and 30°C rise above ambient.

The results are shown in Fig. 1.

The curves show cluster number (number of current carrying contacts surrounding the measured contact, including the measured contact) versus contact current.

The curves will asymptotically approach constant current at large clusters, but are approximately linear on the log-log scale over a cluster range of 1 to 25 in all cases.

Fig. 1 Current carrying capacity per contact for 10 °C and 30 °C temperature rise

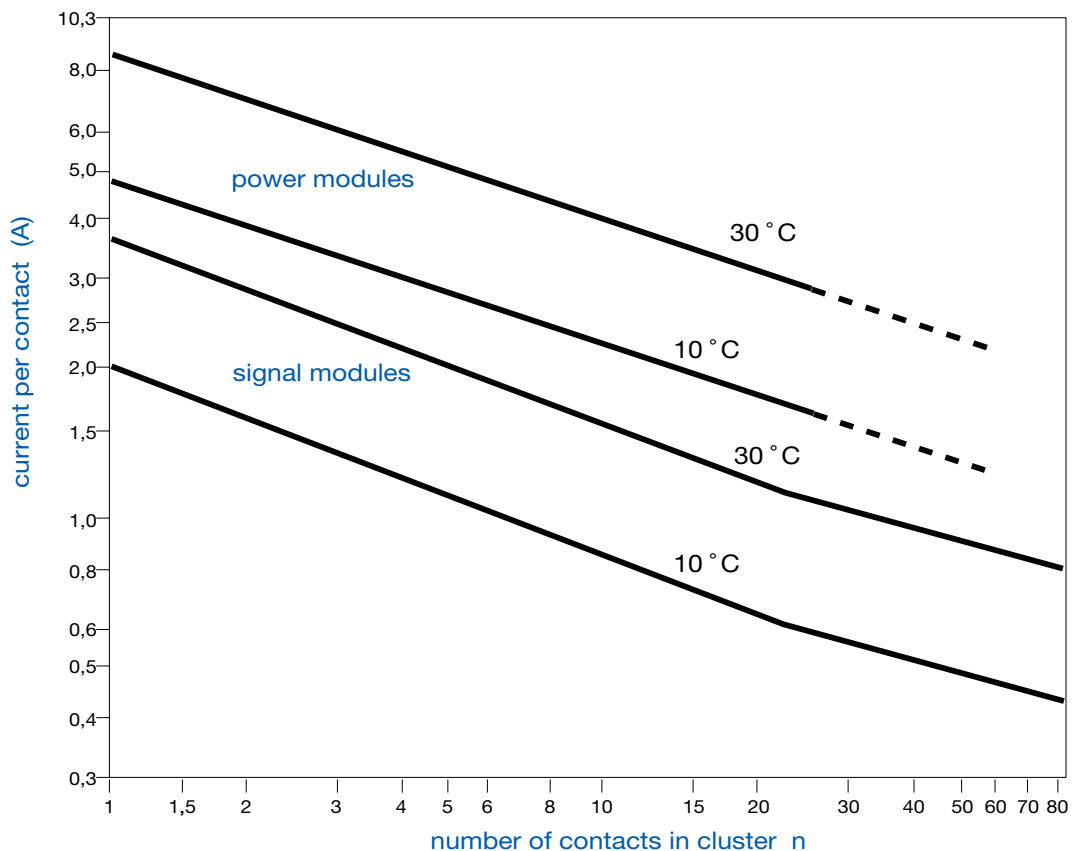

SPICE Parameters.

Some users might prefer to use SPICE parameter representations of the connector to do their own network simulation response studies. These are R,L, and C parameters placed in SPICE parameter formats to be used by a SPICE program.

Hole Specifications

▶ Hole H1	<ul style="list-style-type: none"> • Drill size • Drilled hole tolerance • Copper plating • Tin-lead plating • Finished hole size • Recommended land size 	0,85 mm 0,81 to 0,86 mm 0,025 mm min 0,005 to 0,015 mm 0,65 to 0,80 mm 1,17 mm
▶ Hole H2	<ul style="list-style-type: none"> • Unplated • Plated (for EE receptacle only) <ul style="list-style-type: none"> Drill size Copper plating Tin-lead plating Finished hole size 	2,05 +0,05/-0,00 mm 2,10 mm 0,025 to 0,050 mm 0,005 to 0,015 mm 1,05 to 2,05 mm
▶ Hole H3	<ul style="list-style-type: none"> • Unplated 	1,50 +0,10/-0,00 mm
▶ Hole H4	<ul style="list-style-type: none"> • Unplated-when used with guide pin • Plated - when used with straight screw-to-board high-power plug insert; use pad 5,00 mm min. in dia • Plated - for press-fit power insert <ul style="list-style-type: none"> Drill size Copper plating Tin-lead plating Finished hole size 	3,25 ±0,10 mm 3,25 ±0,10 mm 3,15 ±0,25 mm 0,04 mm min. 0,005 to 0,015 mm 3,00 +0,04/-0,06 mm
▶ Hole H5	<ul style="list-style-type: none"> • Unplated 	6,00 +0,10/-0,00 mm
▶ Hole H6	<ul style="list-style-type: none"> • Plated • When used with right-angle solder-to-board pass-through high-power receptacle insert, use common pad to tie all six holes together • When used with right-angle solder-to-board coax plug insert, surround each hole with pad 1,50 mm in dia. 	1,00 ±0,10 mm 1,00 ±0,10 mm
▶ Hole H7	<ul style="list-style-type: none"> • Unplated 	2,80 +0,10/-0,00 mm
▶ Hole H8	<ul style="list-style-type: none"> • Plated • Recommended land size 	0,70 +0,10/-0,05 mm 1,10 mm max
▶ Hole H9	<ul style="list-style-type: none"> • Unplated 	1,85 ± 0,05 mm

PCB Patterns

PCB Pattern	Family	Applicable to connector type	PCB recommended layout
P1	Signal & Power	receptacle / header wide body / narrow body 4 row RIGHT ANGLE press-fit / solder-to-board / Pin-in-Paste (check P13 for Pin-in-Paste plating lay-out)	
P2	Signal & Power	receptacle / header wide body / narrow body 5 row RIGHT ANGLE press-fit / solder-to-board / Pin-in-Paste (check P14 for Pin-in-Paste plating lay-out)	
P3	Signal & Power	receptacle / header narrow body 4 row STRAIGHT solder-to-board	

PCB Patterns

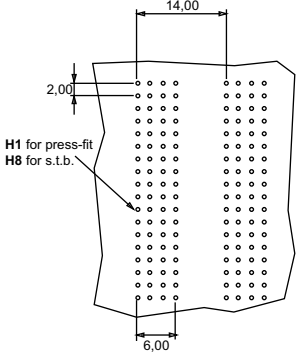
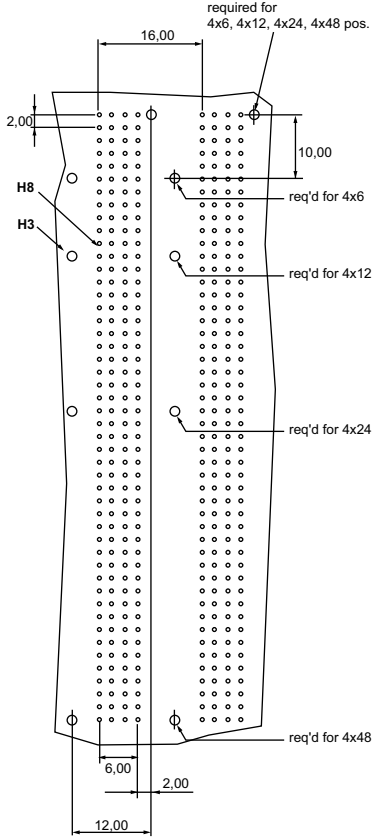
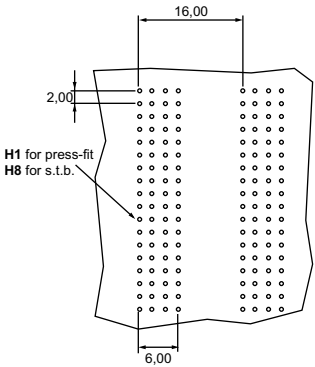
PCB Pattern	Family	Applicable to connector type	PCB recommended layout
P4	Signal & Power	receptacle / header narrow body 4 row STRAIGHT press fit	
P5	Signal & Power	receptacle / header wide body 4 row STRAIGHT solder to board	
P6	Signal & Power	receptacle / header wide body 4 row STRAIGHT press fit	

PCB LAYOUTS

PCB Patterns

PCB Pattern	Family	Applicable to connector type	PCB recommended layout
P7	Signal & Power	receptacle / header wide body 5 row STRAIGHT press fit	<p>H1 for press-fit H8 for s.t.b.</p>
P8	Hybrid	DIN high power receptacle	<p>H2 H3 H6</p> <p>14,00 for narrow body</p>
P9	Hybrid & Accessories	DIN high power header DIN standard Coax header Guide pin	<p>H4 guide pin H4 power press-fit H4 power screw-to-board H5 coax/power coupler H8</p> <p>needed for centerplane application only</p>
P10	Hybrid	DIN high power STRAIGHT receptacle DIN Standard RIGHT ANGLE receptacle	<p>H2 H3 H6 for s.t.b.</p> <p>for DIN power no central hole</p>

PCB Patterns

PCB Pattern	Family	Applicable to connector type	PCB recommended layout
P11	Hybrid	MINI Coax receptacle	
P12	Hybrid	MINI power header MINI Coax header	
P13	Signal	plating lay-out receptacle 4 row Right Angle Pin-in-Paste	
P14	Signal	plating lay-out receptacle 5 row Right Angle Pin-in-Paste	

PCB LAYOUTS

PCB Patterns

PCB Pattern	Family	Applicable to connector type	PCB recommended layout
<p>P15</p>	<p>Signal & Power</p>	<p>receptacle / header wide body 5 row STRAIGHT press-fit Shielded</p>	<p>these holes when using an EE Shroud on opposite side</p>
<p>P16</p>		<p>receptacle / header wide body 5 row STRAIGHT press-fit</p>	<p>required for 5x6, 5x12, 5x24, 5x48 pos.</p> <p>req'd for 5x6</p> <p>req'd for 5x12</p> <p>req'd for 5x24</p> <p>req'd for 5x48</p>
<p>P17</p>	<p>Accessories</p>	<p>board-to-board keying receptacle</p>	<p>this row for EE Female Connector only</p>

PCB Patterns

PCB Pattern	Family	Applicable to connector type	PCB recommended layout
P18	Accessories	board-to-board keying pin	
P19	Accessories	ramping module	
P20	Hybrid	MINI power receptacle	
P21		header wide body 8 row STRAIGHT press-fit	

PCB LAYOUTS

PCB Patterns

PCB Pattern	Family	Applicable to connector type	PCB recommended layout
<p>P22</p>	<p>Signal</p>	<p>receptacle wide body 8 row RIGHT ANGLE press-fit</p>	
<p>P23</p>	<p>High Power</p>	<p>High power header</p>	
<p>P24</p>	<p>High Power</p>	<p>High power receptacle</p>	
<p>P25</p>	<p>Accessories</p>	<p>Hybrid housing</p>	



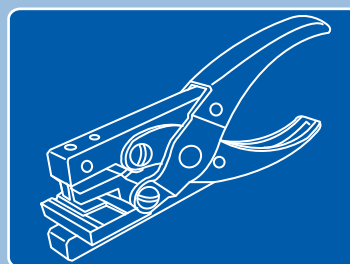
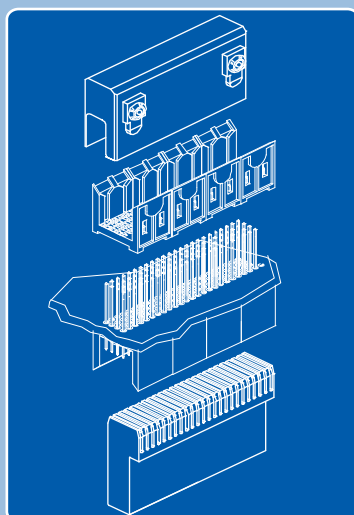

METRAL® APPLICATION EQUIPMENT

 application tooling for the diverse connector types

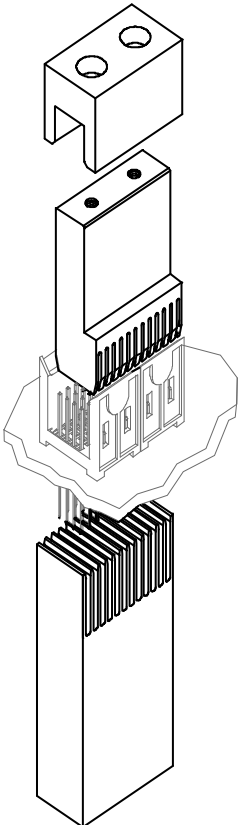
Family	Connector Type	Tooling Description	Tooling Part number	Tooling Application
<p>Signal, Power & Electrical Enhanced</p>	<p>Header Straight</p>	<p>insertion tooling</p>		
		<p>press block holder - 4 and 5 row - 1 mod press block holder - 4 and 5 row - 2 mod press block holder - 4 and 5 row - 4 mod press block holder - 4 and 5 row - 8 mod</p>	<p>415446-001 415446-002 415446-003 415446-004</p>	
		<p>board support - 4 and 5 row board support - 4 and 5 row board support - 4 and 5 row board support - 4 and 5 row</p>	<p>415609-001 415609-002 415609-003 415609-004</p>	
		<p>signal press block - 4 row - 1 mod signal press block - 4 row - 2 mod signal press block - 4 row - 4 mod signal press block - 4 row - 8 mod</p>	<p>166934-001 166934-002 166934-003 166934-004</p>	
		<p>signal press block - 5 row - 1 mod signal press block - 5 row - 2 mod signal press block - 5 row - 4 mod signal press block - 5 row - 8 mod</p>	<p>166935-001 166935-002 166935-003 166935-004</p>	
		<p>power press block - 4 row - 1 mod power press block - 4 row - 2 mod power press block - 4 row - 4 mod power press block - 4 row - 8 mod</p>	<p>416393-001 416393-002 416393-003 416393-004</p>	
		<p>power press block - 5 row - 1 mod power press block - 5 row - 2 mod power press block - 5 row - 4 mod power press block - 5 row - 8 mod</p>	<p>416394-001 416394-002 416394-003 416394-004</p>	

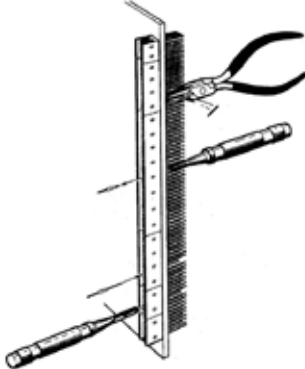
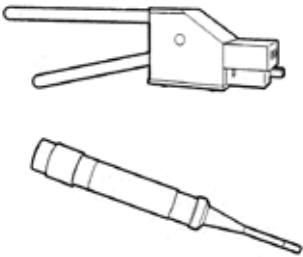
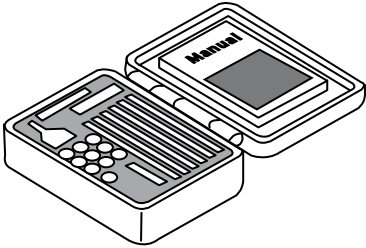
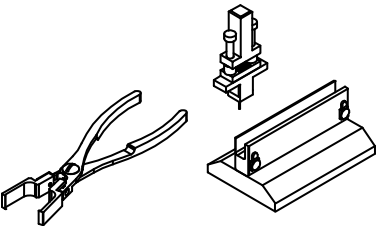
Family	Connector Type	Tooling Description	Tooling Part number	Tooling Application
Signal, Power & Electrical Enhanced	Header Straight	removal tool pin out of backside	MT-330 194208-001	
		removal tool pin out of matingside	MT-340 194204-001	
		self-repair KIT	MT-0370-01	
		multiple pin removal tool - 4 x 6 pos. multiple pin removal tool - 5 x 6 pos.	HT-0531 415878-001 HT-0532 415878-002	

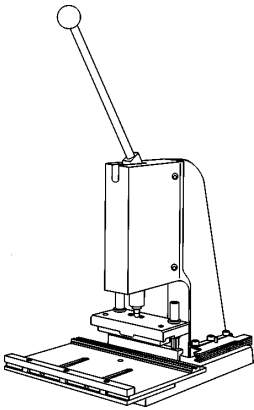
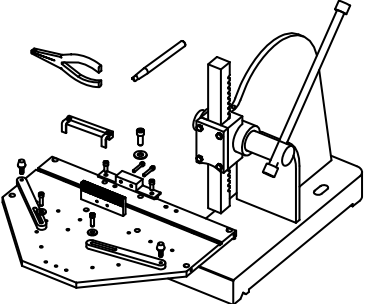
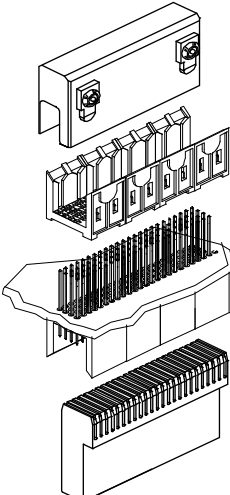
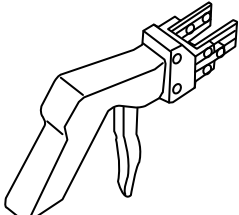
Family	Connector Type	Tooling Description	Tooling Part number	Tooling Application
Signal, Power & Electrical Enhanced	Receptacle Right angle	insertion tool - 4 and 5 row top tool press bar - 8 mod top tool press bar - 1 mod top tool press bar - 2 mod top tool press bar - 4 mod board support bottom tool - 146.2mm	MT-0510 162452-001 162325-001 162325-004 162325-005 162325-007 162383-001	
		removal tool - 4 and 5 row module blade - 1 mod module blade - 2 mod module blade - 4 mod module blade - 8 mod module press bar module press bar module press bar module press bar	HT-0518 415774-001 413773-001 413776-001 413774-001 413775-001 415783-001 415783-002 415783-004 415783-008	
Signal, Power	Shroud	insertion tool 4 row press block 2 mod - 4 row press block 4 mod - 4 row press block 8 mod - 4 row insertion tool 5 row press block 2 mod - 5 row press block 4 mod - 5 row press block 8 mod - 5 row	166934 166623-003 166623-002 166623-001 166935 166624-003 166624-002 166624-001	
Electrical Enhanced	Shroud	removal tool die-cast housing	HT-0516 166816-001	

Family	Connector Type	Tooling Description	Tooling Part number	Tooling Application	
Shielded Connectors	Round Cable Connector	insertion termination tool 4 row	HT-0524		
		insertion termination tool 5 row	HT-0525		
		removal termination tool 4 and 5 row	HT-0522		
		removal termination tool contacts	HT-0523		
		cover assembly tool 4 and 5 row	HT-0520 415810-001		
	shielded cover assembly press	HT-0535 415860-001			
			latch removal	HT-0517	
		Shielded Header & Shroud	insertion press block - 1 mod - 5 row insertion press block - 2 mod - 5 row insertion press block - 4 mod - 5 row insertion press block - 8 mod - 5 row press block holder - 1 mod press block holder - 2 mod press block holder - 4 mod press block holder - 8 mod	416398-001 416398-002 416398-003 416398-004 415446-001 415446-002 415446-003 415446-004	

APPLICATION EQUIPMENT

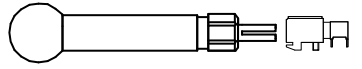
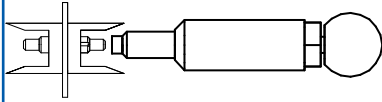
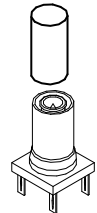
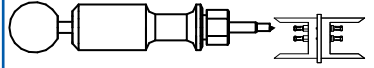
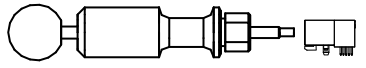
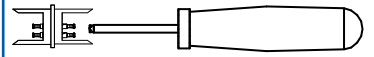
Family	Connector Type	Tooling Description	Tooling Part number	Tooling Application
Hybrid Connector	DIN Standard Coax	extraction tool receptacle housing	HT-0333	
		extraction tool receptacle header	194870	
	Hybrid Connector	insertion header coax contact	HT-0359	
		removal header coax contact	HT-0400	
		Mini Coax	insertion tool coax receptacle	415591-001
	extraction tool coax receptacle		HT-0410	
	removal tool housing		HT-358	

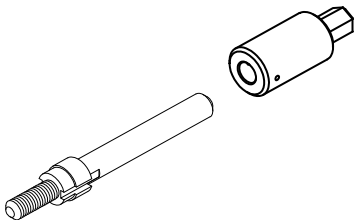
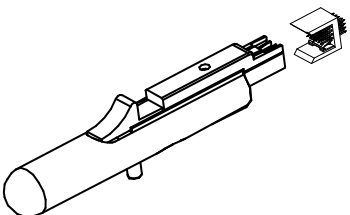
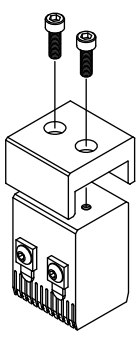
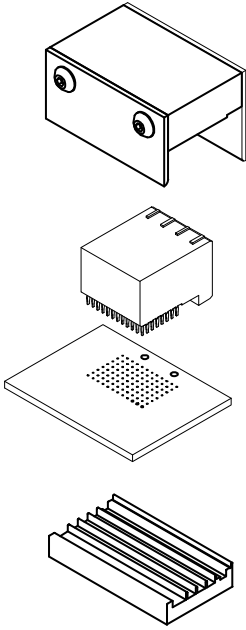
Family	Connector Type	Tooling Description	Tooling Part number	Tooling Application
Accessories	Guide Pin	guide pin insertion and removal tool	415995-001	
	Shorting Clip	insertion tooling - 4 row	409298-001	
insertion tooling - 5 row		409298-002		
Signal 8 row	Header Straight 8 row and Shroud 8 row	insertion tooling 2 mod (8 x 12pos.) press block holder press block board support press block	415921-002 430073-001 416070-001 430073-002	
	Receptacle 8 row	insertion tooling 2 mod (8 x 12pos.) Top tool press bar board support bottom tool	416247-002 415970-002	

APPLICATION EQUIPMENT

For more information about e-catalog or FCI
sales offices, headquarters, agents and local distributors,
visit www.fci.com



Americas - Phone: 1 (800) 237 2374 ■ Europe - - Phone: 33 1 39 49 21 83 ■ Asia/Pacific - Phone: 65 6549 6666

ELXMETRAL0108EA4E

X-ON Electronics

Largest Supplier of Electrical and Electronic Components

Click to view similar products for [Other Tools](#) category:

Click to view products by [Amphenol](#) manufacturer:

Other Similar products are found below :

[CR-0AFL4--332K](#) [568681-1](#) [5800-0090](#) [58061-1](#) [59065-5](#) [59085](#) [00-8273-RDPP](#) [00-8729-WHPP](#) [593033](#) [593072](#) [593564100](#) [593575](#)
[593593](#) [011349-000](#) [CRCW08052740FRT1](#) [LUC-012S070DSM](#) [LUC-018S070DSP](#) [LUC-024S105DSP](#) [599-2021-3-NME](#) [599-JJ-2021-03](#)
[00-5080-YWPP](#) [00-9089-RDPP](#) [00-9300-RDPP](#) [CRCW2010331JR02](#) [601-JJ-06](#) [601-SPB](#) [601YSY](#) [602-JJ-03](#) [602SPB](#) [603-JJ-07-FP](#) [603-](#)
[JJY-04](#) [M15570-25](#) [CRTN1013](#) [CS16](#) [6-1579014-0](#) [CSB3](#) [6203](#) [62200-5709](#) [6240-1](#) [M43435](#) [TY 2](#) [SZ 3](#) [FIN B](#) [BLK](#) [M-5Z](#) [M6816](#) [M7298](#)
[M7456](#) [M7976](#) [660-29ABT1](#) [662508-1](#) [CVHD-950X-93.333](#) [CW104-01X](#) [671-GP-04-KT39-73207](#)