

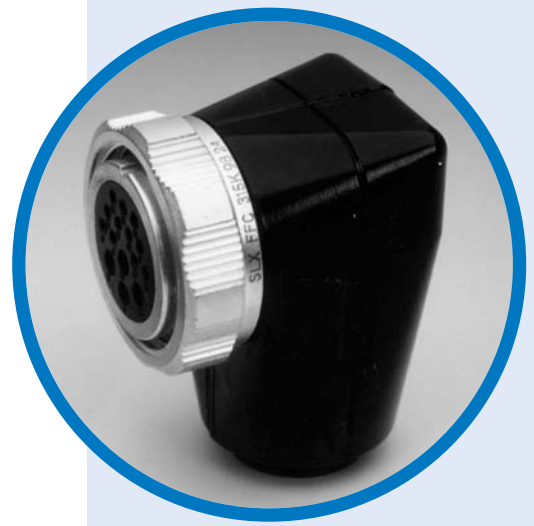

SLX

Crimp version industrial circular connectors



ROHS

- Black coating
- Nickel plating

TECHNICAL CHARACTERISTICS

Mechanical characteristics

- Crimp removable gold plated on nickel underplate machined contacts
- 12 insert arrangements which accept contact gauges AWG 20, 16, 12, in the four different shell sizes 10, 20, 30 & 40
- Temperature range -55°C to 125°C
- Clear cadmium plated, nickel plated and black coated aluminium molded shells
- Mating by screwing system
- Strain-relief integrated to the backshell
- Neoprene inserts
- Reinforced mating screw
- ROHS versions:
 - Black coating (Non conductive)
 - Nickel plating (conductive)
- Performances according to NFF61030

Electrical characteristics

- Contacts characteristics

Contact gauge AWG	20	16	12
Contact diameter (mm)	1	1.5	3
Nominal current (A)	7.5	13	25
Contact resistance (Ohm)	≤ 0.005	≤ 0.002	≤ 0.002
Contact retention in the insert (N)	≥ 30	≥ 40	≥ 45

- Contact arrangements electrical characteristics

Test voltage at sea level (Vrms)	1500	2300	2800
Contact arrangements	14V-17P-22B 23C-212AF-38J 315K	27E-337P 439R	319L-419AR

DESCRIPTION

SLX series are derived from the standard SL series, and have the particularity to use machined contacts with crimp barrels. The one part Neoprene insert provides a use in a temperature range from -55°C to 125°C, the possibility to change the contacts for reparation, and an higher test voltage capability. 12 different contacts arrangements are available which include different contact gauges (20, 16, 12) in the four different shell sizes 10, 20, 30 & 40. SLX series panel drilling is the same as for SL series and SLX series connectors are intermatable with SL series connectors (SLX Plug with SL Receptacle and vice versa).

*Crimp removable
contacts
125°C*

APPLICATIONS

- Instrumentation
- Robotics
- Power supplies
- Transportation
- Entertainment (brand-lights)

SLX



• Contacts and wires

Contact gauge AWG	Crimp barrel		Pin diameter (mm)	AWG gauge	Section mm ²		Diameter over conductor (mm)		Maxi diameter over sleeving (mm)
	Internal diameter in mm	Depth in mm			mini	maxi	mini	maxi	
12	2.5	7.5	3	14-12	1.80***	3.30	1.7	2.45	4.2
16	1.95	6.4	1.6	20 -> 14	0.60*	1.91	1	1.9	2.8
20	1.35	4	1	24 -> 18	0.22**	0.93	0.6	1.3	2.4

* The use of a 800629 reducing sleeve is necessary for cable section less than 0.60 mm²
 ** The use of a 800612 reducing sleeve is necessary for cable section less than 0.22 mm²
 *** The use of a 900092 reducing sleeve is necessary for cable section less than 1.80 mm² for # 16 to 20
 900093 reducing sleeve is necessary for cable section less than 1.80 mm² for # 20 to 24

• Dimensions of the connectors

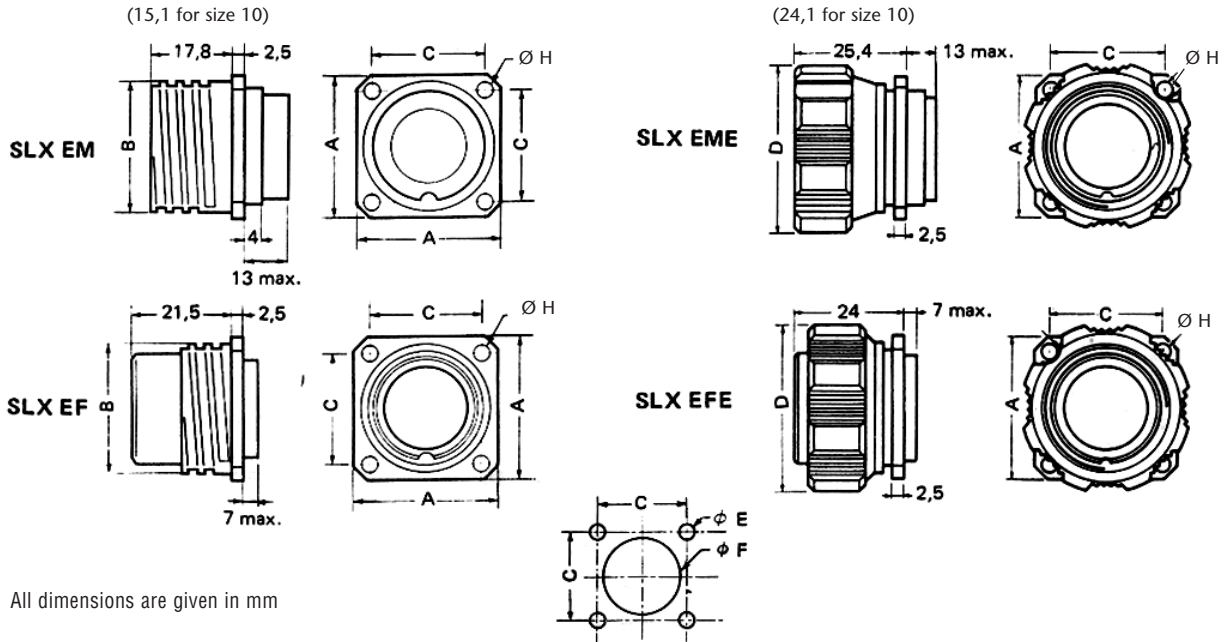

All dimensions are given in mm

For more details about dimensional characteristics, please refer to standard SL data-sheet.
 Some dimensions mentioned below regarding insulators are specific to SLX series.

Receptacle size	A (mm)	Diam. B (mm)	C (mm)	Diam. D (mm)	Diam. E (mm)	Diam. F (mm)	Diam. H (mm)
10	25	21	19	28	3.2	16.5	3.2
20	31	28.1	24	37	3.5	25.5	3.5
30	46	42.2	34	52	3.5	35.5	3.5
40	56	52.2	41	65	3.5	47	3.5

Contacts insert arrangements

Mating face view of the male insert

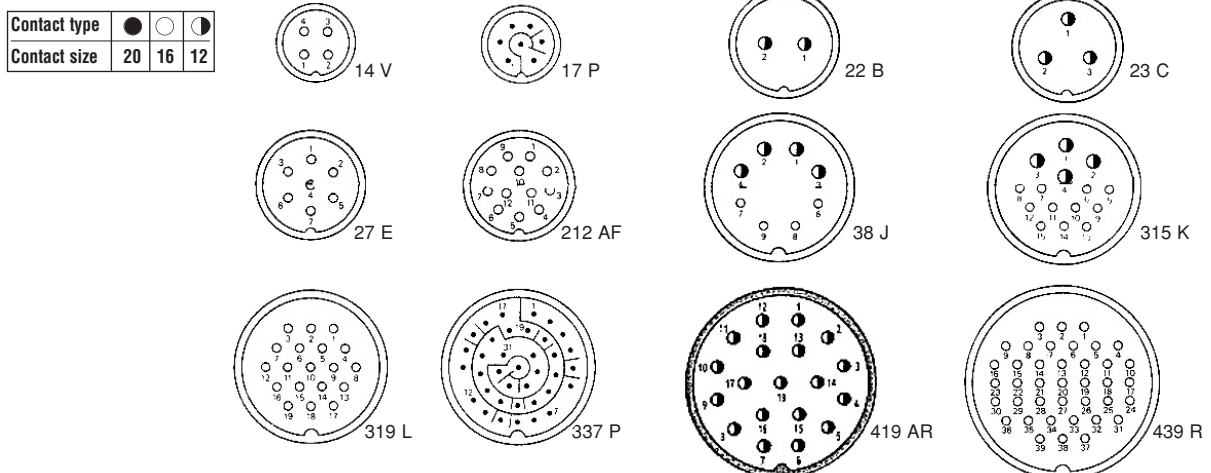

Straight or right-angle backshell

Connector size	Backshell reference					
	black* (non conductive)	straight nickel* (conductive)	green cadmium (conductive)	black* (non conductive)	right-angle nickel* (conductive)	green cadmium (conductive)
10	47377N	47377NI	21458N	47381N	47381NI	21462N
20	47378N	47378NI	21459N	47382N	47382NI	21463N
30	47379N	47379NI	21460N	47383N	47383NI	21464N
40	47380N	47380NI	21461N	47384N	47384NI	21465N

* Black and Nickel Backshells are ROHS compliant.

- Straight or right-angle backshells are delivered with different clamping pads.

- Green backshells (conductive finish) are delivered with metallised clamping pads.

Contacts as spare parts*

Contact gauge AWG	12	16	20
Part-number for one pin	21713	800660	800650
Part-number for one socket	21728	800664	800654

* For arrangement 419 AR and 23C: Part-number for one pin: 35941
Part-number for one socket: 35970

Accessories

Plug and receptacle protection caps:

SLB	F	M	3B
F: Plug			
E: Receptacle			
M: Pin connector			
F: Socket connector			
Plug and receptacle: none			
Line mount receptacle: R			
Size			
1B: 10	3B: 30		
2B: 20	4B: 40		



Receptacle with locking ring protection caps:

BF	F	3B
M: Pin connector		
F: Socket connector		
Size		
1B: 10	3B: 30	
2B: 20	4B: 40	



Sealing sleeve:

Connector	Size	Ref.
Straight	10	43458
Right-angle	10	43473
Straight	20 or 30 40	43456
Right-angle		44666
		43457



for plug or line mount receptacle

Adaptator for flexible conduit and PG:

	Connector size	PG thread
SL RF 209N	20	9
SL RF 211N	20	11
SL RF 313N	30	13
SL RF 316N	30	16
SL RF 416N	40	16
SL RF 421N	40	21
SL RF 429N	40	29



- Caps and sealing sleeves are ROHS.

Cabling tools

• Crimping tools

• Crimping pliers: **809857** (Mil. P/N: M22520/1-01)

• Positioner: **21770**

For arrangement 419 AR and 23C: **TP943**

• Controlling gauge: **809907** (Mil. P/N: M22520/3-1)
(Selector number: 4)

• Contacts insertion and removal

Contacts	Insertion tool P/N	Removal tool P/N
# 12: Pin	141900	21746
# 12: Socket	141900	21745
# 16: Pin	48680	809731
# 16: Socket	48680	809732
# 20: Pin	39048	809729
# 20: Socket	39048	809730

Cabling process

• Crimping process

Place the positioner in the pliers.

Choose the selector number on the positioner according to the contact size to crimp.

Strip the wire end (7.5mm for size 12 contact / 6mm for size 16 contact / 4mm for size 20 contact).

Insert the wire in the crimp barrel of the contact and check through the inspection hole of the contact that wire is well-placed.

Place the contact with the wire into the pliers until the stop. Completely close the tool and after, let it open itself.

Visually check if crimping is correct and by the inspection hole of the contact if the wire is well-placed in the crimp barrel.

• Contact insertion

Insert the wired contact in the groove of the tool, taking care that the extremity of the tool touches the shoulder of the contact. Insert the contact in its cavity from wiring side and steadily push the tool along the axis of the cavity until the contact locks home.

Carefully withdraw the tool, applying a forward pressure on the wire.

Pull on the wire to check that the contact is correctly locked.

• Contact removal

Insert the tool from the mating side and push it along the contact axis until contact unlocks.

Pull the contact out from the rear of the connector.

Plug and Inline receptacle (backshell sets included)

ROHS Part Numbers : nickel plated or black coatedX

SLX series	SLX	D	F	M	D	319L
D: Black coating						
Blank: Nickel plating						
F: plug or inline receptacle						
Type of contact:						
M: Male						
F: Female						
D: plug + straight backshell						
DR: inline receptacle + straight backshell						
C: plug + right angle backshell						
Contact Arrangement (see page 2)						
Blank: Black coating						
NI: Nickel plating						

Non ROHS Part Numbers : clear cadmium plated

SLX series	SLX	F	M	D	319L
F: plug or inline receptacle					
Type of contact:					
M: Male					
F: Female					
D: plug + straight backshell					
DR: inline receptacle + straight backshell					
C: plug + right angle backshell					
Contact Arrangement (see page 2)					

Panel mount receptacle and receptacle with locking ring

ROHS Part Numbers : nickel plated or black coated

SLX series	SLX	D	E	F	319L
D: Black coating					
Blank: Nickel plating					
E: receptacle or receptacle with locking ring					
Type of contact:					
M: Male					
F: Female					
Blank: Receptacle					
E: Receptacle with locking ring					
Contact Arrangement (see page 2)					
Blank: Black coating					
NI: Nickel plating					
Add "MA" for tin plated retention ring (grounding)					

Non ROHS Part Numbers : clear cadmium plated

SLX series	SLX	E	F	319L
E: receptacle or receptacle with locking ring				
Type of contact:				
M: Male				
F: Female				
Blank: Receptacle				
E: Receptacle with locking ring				
Contact Arrangement (see page 2)				
Add "MA" for tin plated retention ring (grounding)				

Comment : Panel gasket is delivered with the receptacle

Comment : Panel gasket is delivered with the receptacle

Body of plug and inline receptacle

With those part numbers the straight and right angle backshells are not included.

To define part numbers of backshells, please to consult page 2.

ROHS Part Numbers : nickel plated or black coated

SLX series	SLX	D	B	M	319L
D: Black coating					
Blank: Nickel plating					
Body of plug or inline receptacle					
Type of contact:					
M: Male					
F: Female					
Blank: Body of plug					
R: Body of inline receptacle					
Contact Arrangement (see page 2)					
Blank: Black coating					
NI: Nickel plating					

Non ROHS Part Numbers : clear cadmium plated

SLX series	SLX	B	M	319L
Body of plug or inline receptacle				
Type of contact:				
M: Male				
F: Female				
Blank: Plug				
R: inline receptacle				
Contact Arrangement (see page 2)				

Do not hesitate to contact us for further information



Amphenol Socapex

948, Promenade de l'Arve - BP 29

F - 74311 Thyez Cedex

Tel.: +33 (0) 4 50 89 28 00 - Fax: +33 (0) 4 50 96 29 75

<http://www.amphenol-socapex.fr>

X-ON Electronics

Largest Supplier of Electrical and Electronic Components

Click to view similar products for [Standard Circular Connector](#) category:

Click to view products by [Amphenol](#) manufacturer:

Other Similar products are found below :

[5M2530B10P](#) [600259N006](#) [600273N007](#) [6134-336-13149](#) [6134-337-11149](#) [6134-337-2390](#) [6134-341-17149](#) [6280-4SG-516](#) [6280-7SG-3DC](#)
[6290](#) [6291A](#) [66200A-10](#) [680-SMG](#) [681-PMG](#) [CXS3102A14S2P](#) [CXS3102A181S](#) [7251-6SG-300](#) [7271-6SG-300](#) [7282-3PG-300-CH3](#) [75-](#)
[474014-05S](#) [75-474618-01S](#) [75-474618-04P](#) [75-474618-04S](#) [799539-000](#) [MI8-SE](#) [805-005-07NF11-19PC](#) [805-005-07NF15-7PA](#) [8280-4PG-](#)
[516](#) [8280-7PG-519](#) [8282-5PG-519](#) [836783-1](#) [MP-4102-25P-C](#) [862256-1](#) [864019-2](#) [866857-1](#) [867865-1](#) [PT01SP-14-18P](#) [PT08P-14-5S](#)
[PTSF06SE-14-12S](#) [120-1833-000](#) [QCM019PC2DC012B](#) [1-2069279-1](#) [121583-0217](#) [121667-0020](#) [129591AU](#) [1000B BULK](#) [RD10A16-19-](#)
[P6CS051/1](#) [RD10A20-31-P8CS051/1](#) [RD16A14-12-S6CS051/2](#) [1301240290](#) [1301240347](#)