

Amphenol Filtered Connectors

Filtered ARINC
Connectors

Filtered MIL-C-24308
Connectors

Discrete Filters

Filter Plates

Filter Terminal Blocks

Amphenol

Amphenol Canada Corp.
an ISO 9001 company



About The Company

Amphenol Canada, a subsidiary of Amphenol Corporation, is an international leader in the manufacture of filter connectors and has been pioneering EMI and EMP technologies for more than 40 years.

Located in Toronto, Canada, our modern 60,000 sq. ft. facility employs approximately 250 people, and is dedicated to the manufacture of filter connectors. We design, develop and manufacture EMI and EMP filter connectors which are used world-wide in Military, Aerospace, Communication and Commercial applications. Our products are unique, offering stress-isolated,

solderless technology in tubular, planar, and chip capacitor designs.

Amphenol Canada is vertically integrated and, with the exception of diodes, has the capability of manufacturing all elements of our filter connectors. We also have the support of other Amphenol divisions in an integrated working relationship as one of the largest connector manufacturing companies in the world.

Our expertise in understanding and supporting our customers' filter interconnect needs has earned us a reputation of quality and excellence among the world's leading users of electronic components.

A m p h e n o l C u s t o m P r o d u c t s

**Amphenol custom products.
Helping to make design
dreams reality.**

Amphenol
Aerospace Products

C o n n e c t i n g S o l u t i o n s

The advertisement features a collection of various Amphenol filter connectors, including tubular, planar, and chip capacitor designs, set against a background of a blue sky and a horizon line. The text is arranged in a clean, professional layout, with the company name and logo prominently displayed.

Table of Contents

Introduction to Filter Connectors

Advantages of Filter Connectors	2
Filter Connector Design	2
Filter Connector Selection	3

Filtered ARINC 600 and 404 connectors (485 series)

Introduction and Design Features	4
Cross-section and Material Specification	5
Electrical Characteristics	6
ARINC 600 Dimensions	7 and 8
ARINC 600 Insert Arrangements	9
ARINC 404 Dimensions	10 and 11
ARINC 404 Insert Arrangements	12
ARINC 404 and 600 Termination Styles	12
Transient Suppression for Lightning and EMP Applications	13
Diode/MOV Electrical Characteristics	14
Filter/Diode Connector Transient Response.....	15
Termination Module	15
ARINC Accessories	16
ARINC Part Numbering System	16

Filtered D-Sub Connectors (308 Series)

Introduction	17
--------------------	----

308 Series (Planar design)

Cross-section and Material Specification	18
Electrical Characteristics	19
Dimensions	20
Termination Styles	21
Mounting Styles	21 and 22
Part Numbering System	22

Insert Arrangements	23
Panel Cutout	23

FX Series

Filter Terminal Blocks, Discrete Filters and Specials	24
---	----



Advantages of Filter Connectors

The integration of the filter elements into the connector, rather than a board level solution, results in many advantages to the user:

- reduction in space and weight
- reduction in inspection and assembly labour

- improved high frequency EMI performance by elimination of parasitic effects associated with board level filters
- superior shielding effectiveness

Filter Connector Design

Filter connectors have been used for over thirty years to provide cost and space effective solutions to EMI problems in a wide range of military and commercial applications including avionics systems, satellites, missiles, communications, control systems and tempest equipment. A low pass filter connector incorporates capacitors and ferrite inductors into the connector body. The two capacitor types commonly used in filter connectors for military or

avionics applications are planar arrays and tubular capacitors. Each of these capacitor types is an efficient filter at high frequencies (>1 GHz) and has been proven to be extremely reliable when suitably assembled into a connector. Both planar and tubular designs feature Amphenol's unique solderless construction which reduces stress on the ceramic elements and results in superior physical and thermal shock capabilities.

Planar Array

Amphenol Canada's planar design consists of planar ceramic capacitor arrays and discrete ferrite inductors assembled concentrically over the contacts and into the connector shell. The planars are compressed between rubber gaskets and have contact springs in each position which form a stress isolated connection with the contact body. The planars are grounded to the shell via a ground spring.

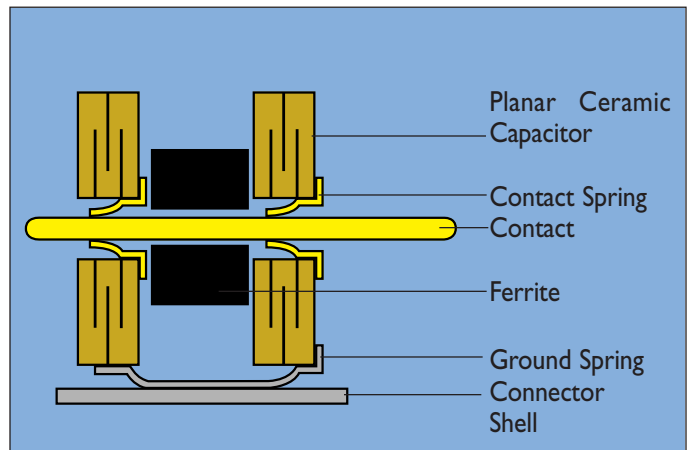

Tubular Capacitor

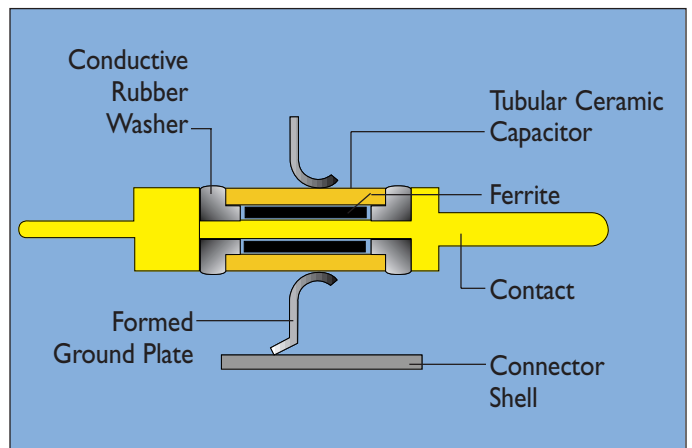

Amphenol Canada's tubular design consists of a ferrite bead and ceramic tubular capacitor assembled onto a machined contact. The filter tube is connected to the contact with conductive rubber washers to provide a stress-isolated contact assembly. Grounding is achieved via a ground plate.



Filter Connector Selection

Selection of a particular filter circuit will depend on the required insertion loss characteristics and the system source and load impedances. By arranging the capacitive and inductive elements in a variety of combinations a number of equivalent circuits may be attained. These filter types are available in a

wide range of capacitance and voltage values and may be selected in virtually any combination within the connector insert. In addition to filter contacts, insulated contacts, ground contacts and sealing plugs are available.

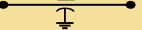
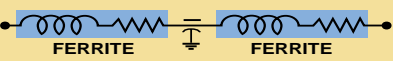
	Filter Circuit	Best Filtering Application
PI		Unknown or medium source and load impedance
LRC		Low source and high load impedance
CLR		High source and low load impedance
C		High source and high load impedance
T		Low source and low load impedance

High source or load impedance >100ohms

Low source or load impedance <10ohms

The following factors may affect the filter performance, and should be considered when selecting a filter connector:

Operating Voltage

As a DC voltage is applied across a capacitor, the dielectric constant decreases resulting in a capacitance decrease and a reduction in filter performance. The magnitude of the change is dependant upon the type of ceramic material used, the dielectric thickness and the magnitude of the voltage applied.

Operating Currents

Operating currents cause magnetic saturation of inductive elements (ferrites). Therefore filters with ferrite inductors (Pi, CLR, LRC and T) will perform much like C filters as the ferrite approaches saturation.

Operating Temperature Range

Capacitance and insertion loss performance are shown at 25°C. Depending on the type of ceramic material being used, capacitance can drop by up to 80% at temperature extremes. However, commonly used dielectrics have temperature coefficients of +/- 15% from -55°C to +125°C.

Transient Voltage Requirements

Some transient voltage requirements may necessitate the addition of diodes or MOV's to the PCB or in the connector.



485 Series Introduction and Design Features

The Amphenol 485 series is a range of filtered ARINC 404 and 600 rack and panel connectors designed to provide space and cost-effective solutions to EMC compliance issues in avionics products. Amphenol's filtered ARINC connectors are used extensively on Boeing, McDonnell Douglas and Airbus avionics equipment and a wide range of other military and commercial applications. The majority of the Amphenol filtered ARINC

connector designs incorporate planar capacitor array technology in a solderless, stress-isolated configuration. This results in superior thermal and physical shock performance and unparalleled long term reliability. These products have been extensively qualified to the requirements of ARINC 600-9 and MIL-C-81659 and there are numerous qualification test reports available for review.

Front Removable Socket Contact Stability

One significant feature of the Amphenol filtered ARINC connector is the ability to remove the front socket contact. This is an important design feature as the size 22D socket contacts in ARINC 404 and 600 connectors are exposed and therefore susceptible to damage. This is one of the most common in-service problems of standard ARINC connectors. A front removable socket contact avoids the potential cost and inconvenience of removing the connector from the avionics box and results in long term improvements in maintainability and reduction in life cycle costs. It is important that the front

removable socket be designed such that the contact is mechanically stable and properly positioned to meet the connector interface and mating specifications. The Amphenol design provides for excellent true position location and contact stability by virtue of the solderless design. The Amphenol contact is stabilized at the front by a plastic stabilization insert, through the length of the connector and at the rear engagement area. This approach provides for the best possible contact location and stability and is further augmented by the use of an environmental seal at the connector mating interface.

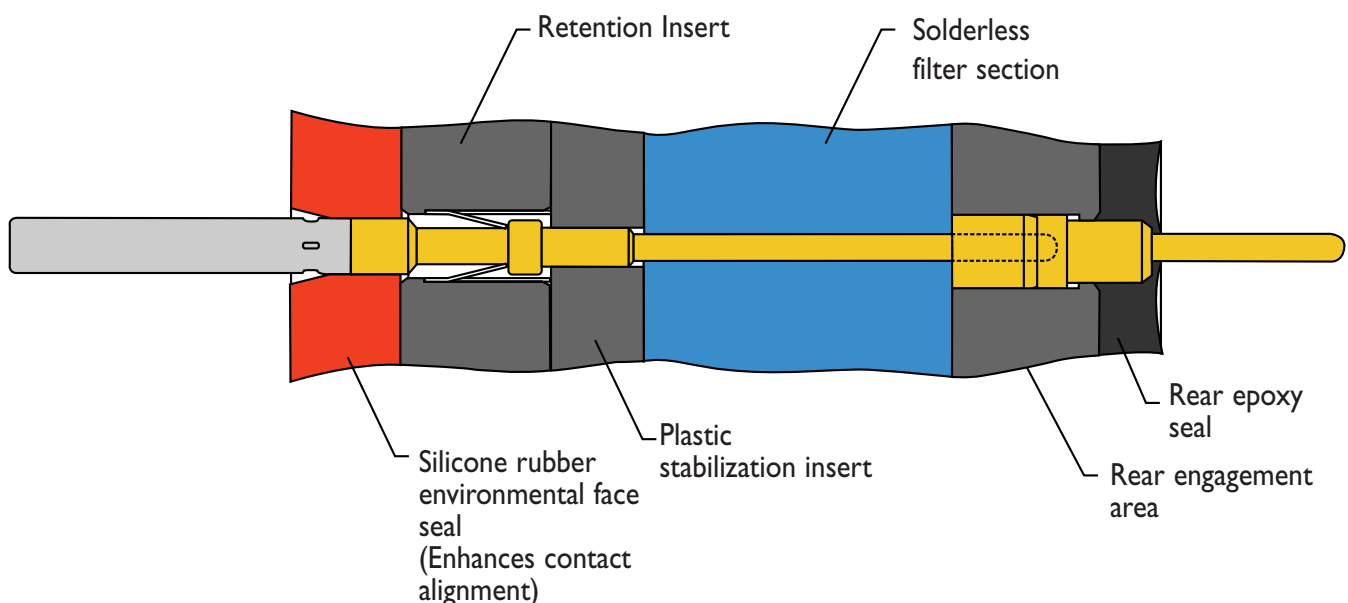

ARINC Filter Connector Construction and Material Specifications

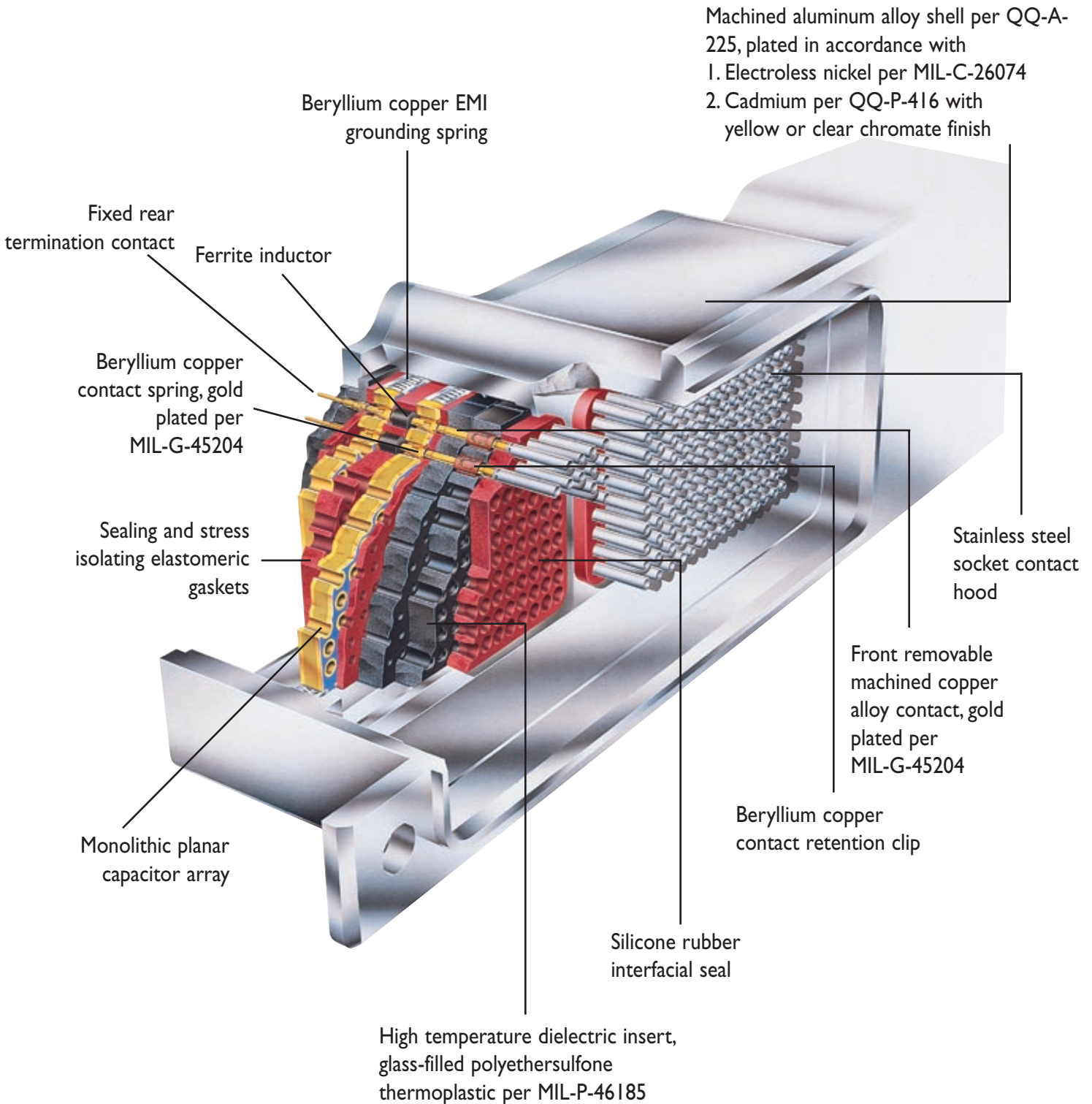

Electrical Characteristics

Filter Circuit	PI				C, CLR, LRC, T					
Filter Type	PA4	P02	P04	P08	CA2	C01	C02	C04	C22	C50
Capacitance (pF) (@ 25°C, 1kHz & 1.0 VRMS)	400 to 800	1800 to 3600	4000 to 8000	8000 to 16000	200 to 400	900 to 1800	1800 to 3600	4000 to 8000	22000 to 40000	50000 to 100000
Insertion Loss* (dB min.) (per MIL-STD-220 at 25°C & no load)	.1 MHz	-	-	-	-	-	-	-	-	3
	1 MHz	-	-	2	5	-	-	-	10	15
	10 MHz	2	10	15	18	-	4	8	13	26
	100 MHz	20	38	50	55	10	20	25	33	45
	1000 MHz	58	60	60	63	25	35	40	50	52
Working Voltage (VDC) (@ 25°C & sea level)	200								100	
Dielectric Withstanding Voltage (VDC) (@ 25°C & 50 mA max. charging current)	500								300	
Insulation Resistance (Gohms) (@ 25°C & working voltage)	10									
Current Rating by Contact Size (continuous max., DC amperes)	#22 = 5 Amps #20 = 7.5 Amps					#16 = 13 Amps #12 = 23 Amps				
Filter RF Current Rating (amperes) (max. @ any frequency)	3									

Note: Other capacitance values, mixed capacitance arrangements, ground and insulated contacts are available. Consult the factory for your particular application.
* Acceptance testing performed to 500MHz maximum

Typical Insertion Loss Performance

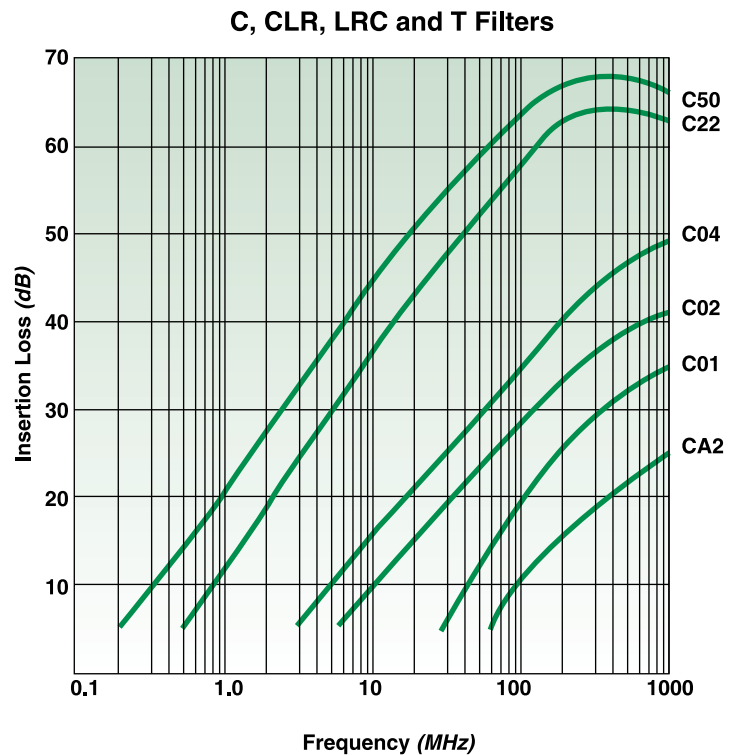
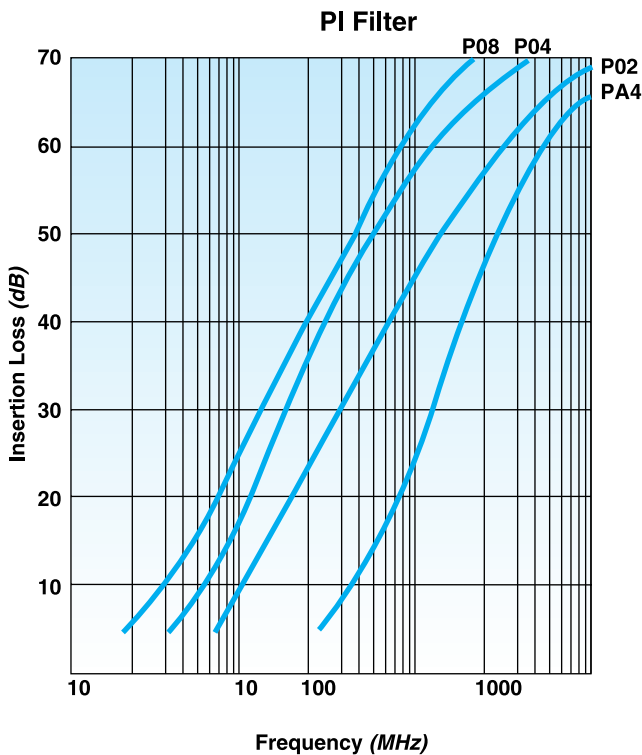

ARINC 600 Style Filter Connectors

Receptacle Shell Size 1

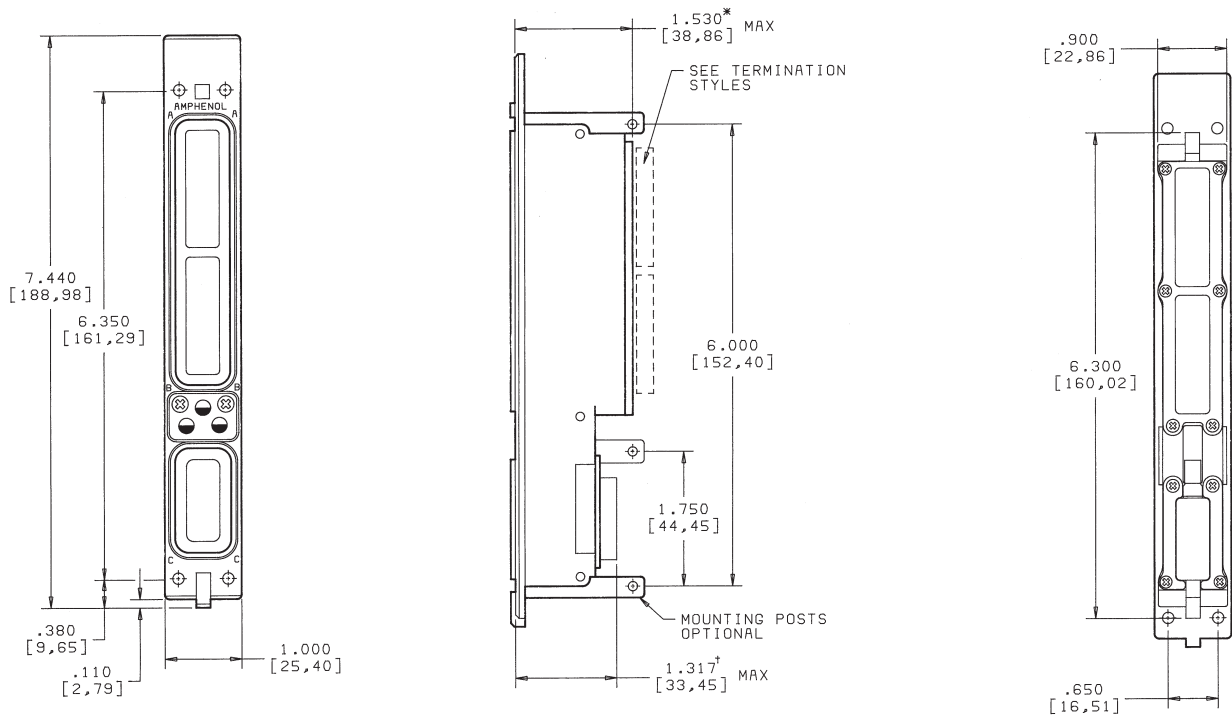

Receptacle Shell Size 2

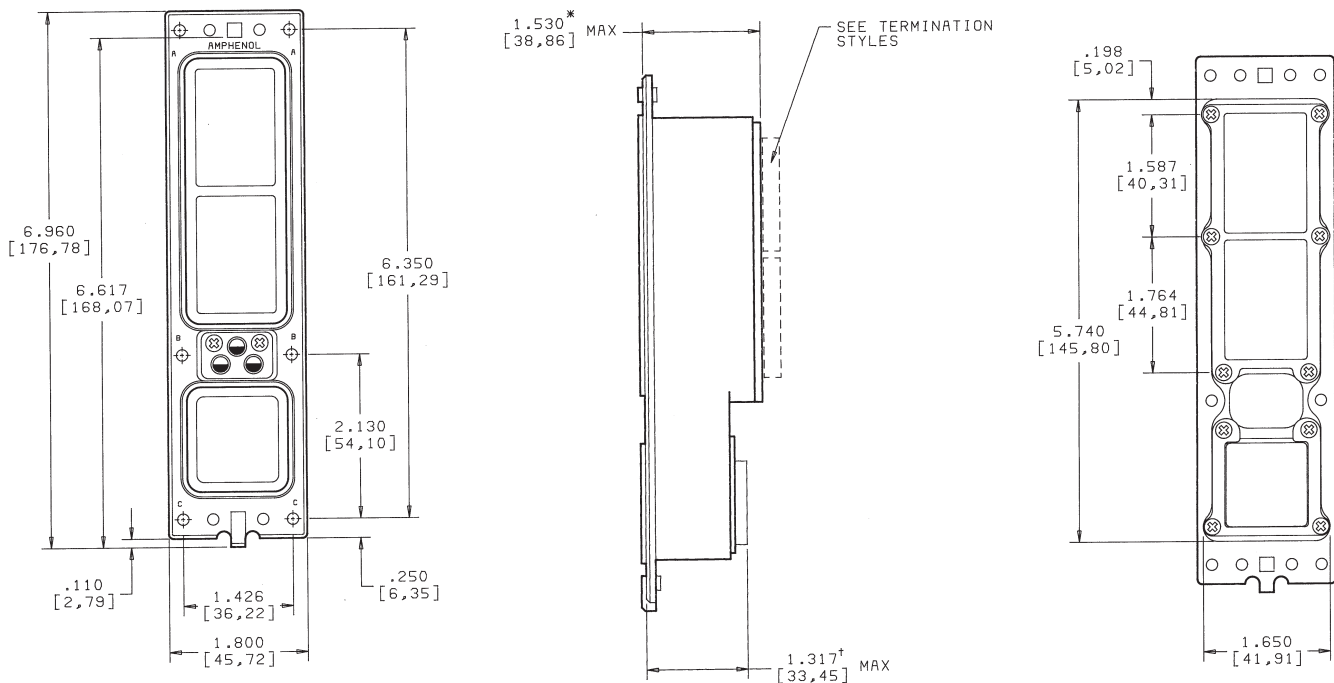

*This dimension is for all filter styles with PCB, wire wrap or solder cup terminations. For environmental class connectors with rear release contacts, add .600" (15,24mm). Shorter length designs are available. Consult the factory for details.

Note: Size 22D contacts are supplied installed and are removable with Amphenol insertion/removal tool 485-905. Cavity C and F power contacts are packaged separately. Coax and triax contacts may be ordered separately.

† Cavity C dimension is shown unfiltered

ARINC 600 Style Filter Connectors

Receptacle Shell Size 3

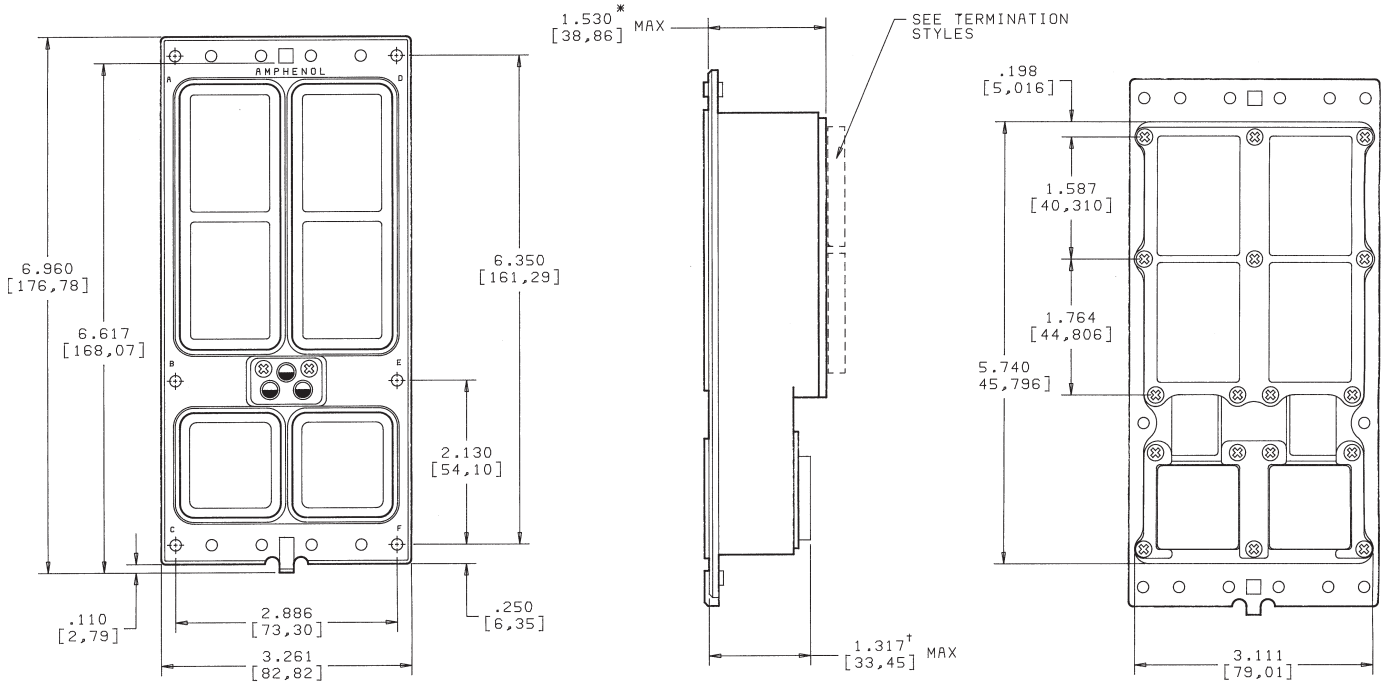

MIL-C-83527 Style Filter Connectors

Receptacle Shell Size 3

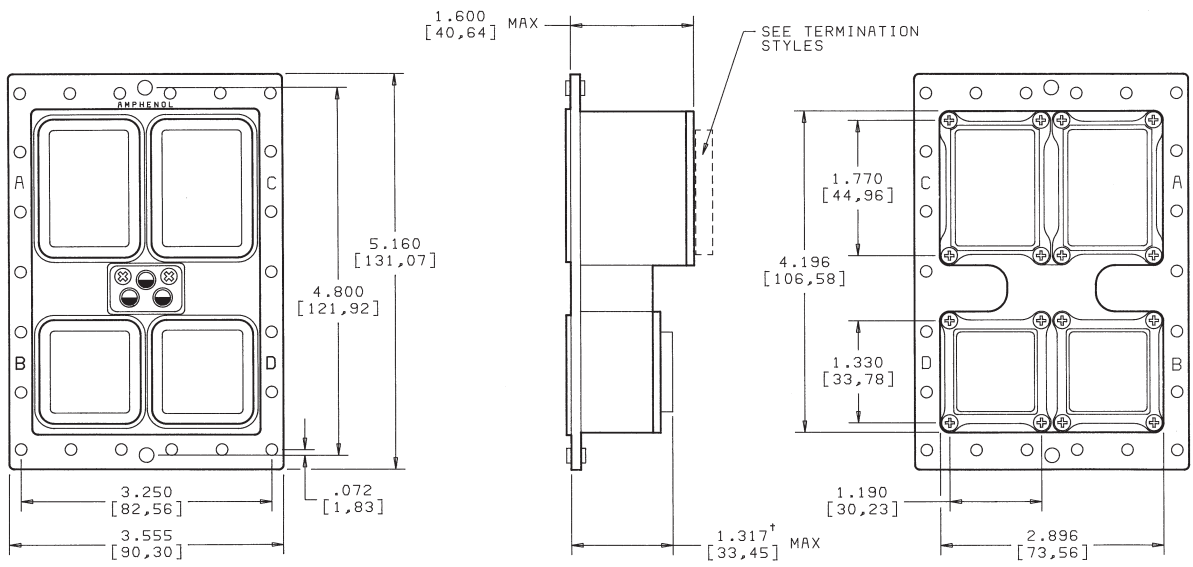

*This dimension is for all filter styles with PCB, wire wrap or solder cup terminations. For environmental class connectors with rear release contacts, add .600" (15,24mm). Shorter length designs are available. Consult the factory for details.

Note: Size 22D contacts are supplied installed and are removable with Amphenol insertion/removal tool 485-905. Cavity C and F power contacts are packaged separately. Coax and triax contacts may be ordered separately.

† ARINC 600 Cavity C and F and MIL-C-83527 Cavity B and D dimensions are shown unfiltered.

ARINC 600 Insert Arrangements

Shell Size 2 or 3, Cavity A, B, D or E

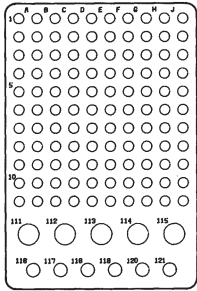

Insert 121
110 #22 Contacts
5 #16 Contacts
6 #20 Contacts

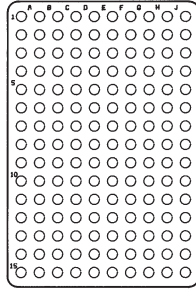

Insert 150
150 #22 Contacts

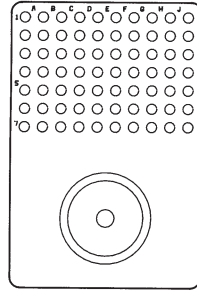

Insert 71C1
70 #22 Contacts
1 #1 Coax Contact

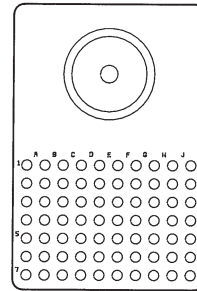

Insert 71CIA
70 #22 Contacts
1 #1 Coax Contact

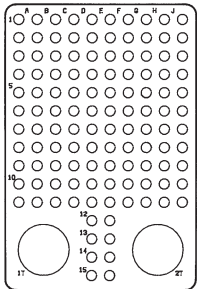

Insert 120T2
118 #22 Contacts
2 #8 Triax/Coax Contacts

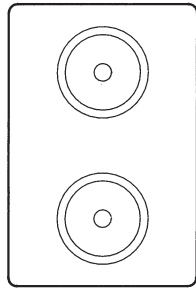

Insert C2
2 #1 Coax Contacts

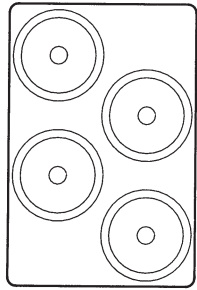

Insert C4
4 #1 Coax Contacts

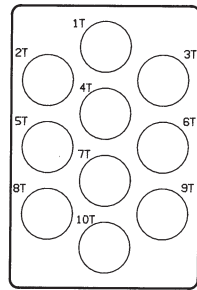

Insert 10T10
10 #8 Triax/Coax Contacts

Shell Size 2 or 3, Cavity C or F

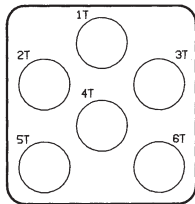

Insert 6T6
6 #8 Twinax/Coax Contacts

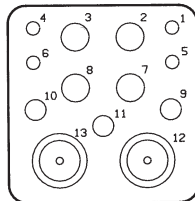

Insert 13C2
4 #12 Contacts
3 #16 Contacts
4 #20 Contacts
2 #5 Coax Contacts

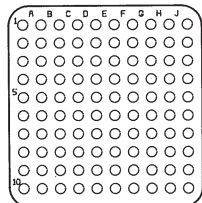

Insert 100
100 #22 Contacts

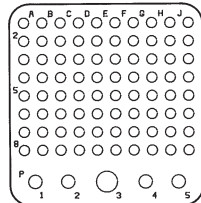

Insert 85
80 #22 Contacts
4 #20 Contacts
1 #16 Contact

Shell Size 1

Cavity A or B

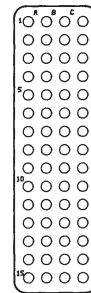

Insert 60
60 #22 Contacts

Cavity C

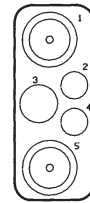

Insert 5C2
1 #12 Contact
2 #16 Contacts
2 #5 Coax Contacts

Note: Consult the factory for other insert patterns.

ARINC 404 and MIL-C-81659 Filtered Connectors

Receptacle Shell Size 1

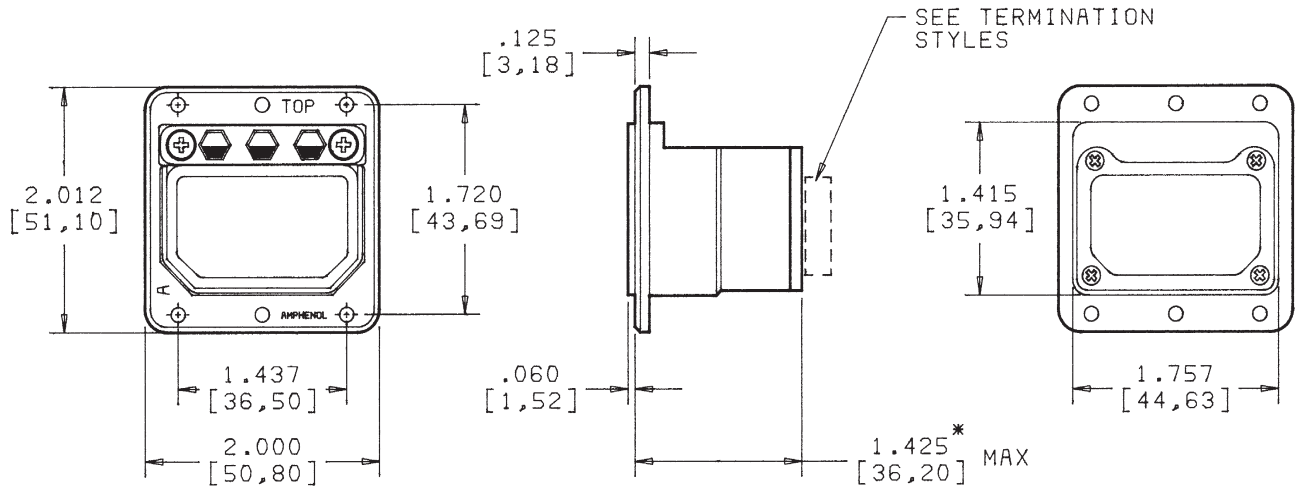

Receptacle Shell Size 2

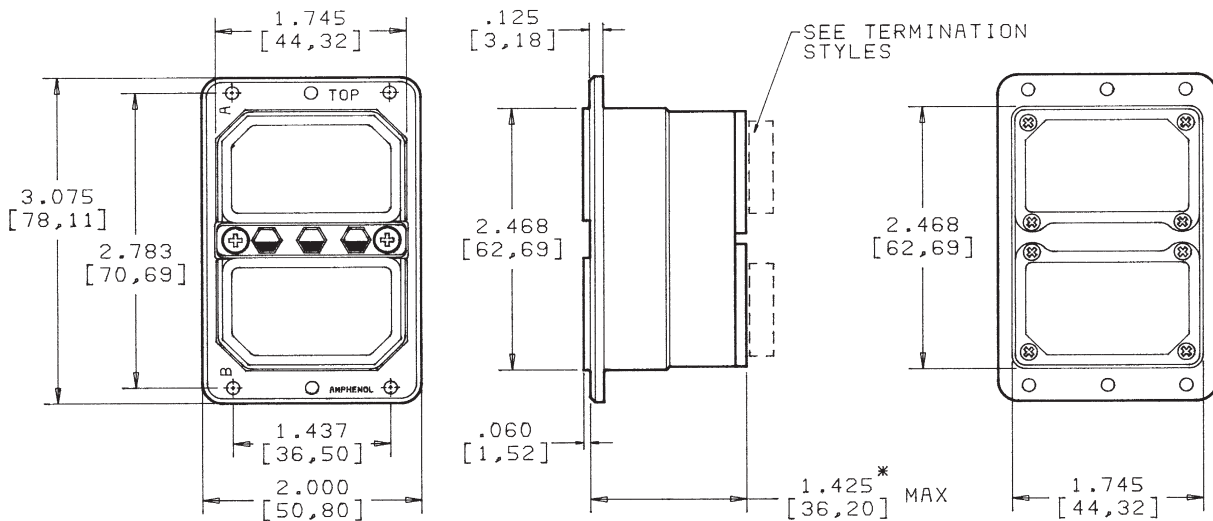

*This dimension is for all filter styles with PCB, wire wrap or solder cup terminations. For environmental class connectors with rear release contacts, add .600" (15,24mm). Shorter length designs are available. Consult the factory for details.

Note: Size 22D contacts are supplied installed and are removable with Amphenol insertion/removal tool 485-905. Pin contacts are not removable. Coax and triax contacts may be ordered separately.

ARINC 404 and MIL-C-81659 Filtered Connectors

Receptacle Shell Size 3

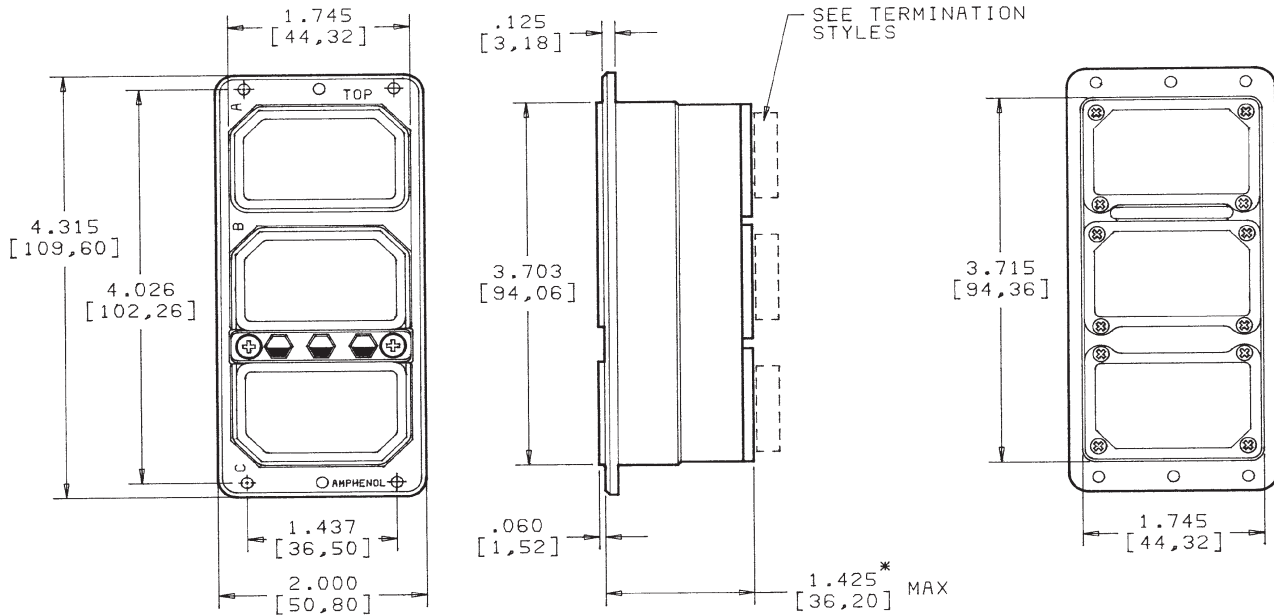

Receptacle Shell Size 4

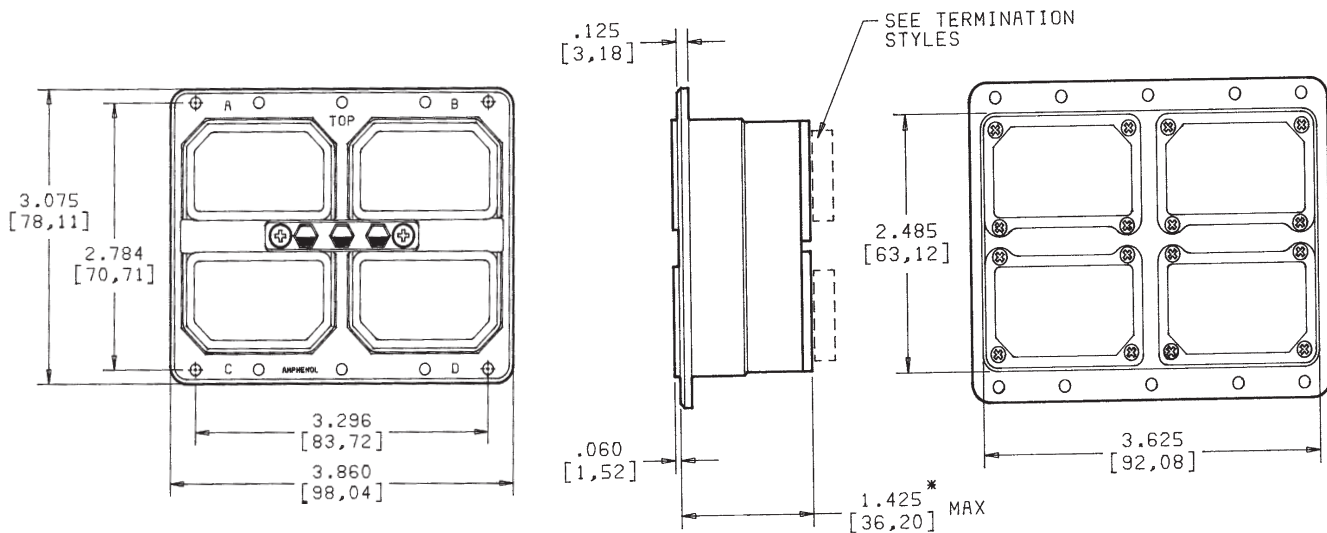

*This dimension is for all filter styles with PCB, wire wrap or solder cup terminations. For environmental class connectors with rear release contacts, add .600" (15,24mm). Shorter length designs are available. Consult the factory for details.

Note: Size 22D contacts are supplied installed and are removable with Amphenol insertion/removal tool 485-905. Pin contacts are not removable. Coax and triax contacts may be ordered separately.

ARINC 404 and MIL-C-81659 Insert Arrangements

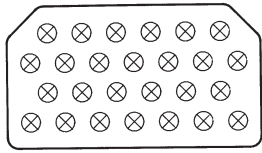

Insert 26
26 #16 Contacts

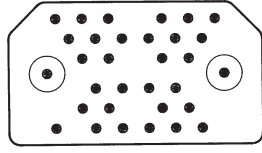

Insert 32C2
30 #20 Contacts
2 #5 Coax Contacts

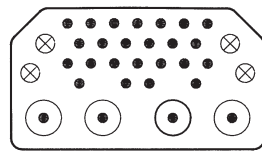

Insert 32C4
24 #20 Contacts
4 #16 Contacts
4 #5 Coax Contacts

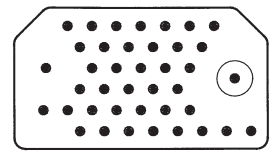

Insert 40C1
39 #20 Contacts
1 #5 Coax Contact

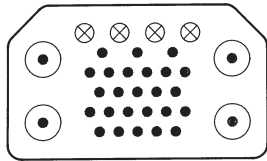

Insert 33C4
25 #20 Contacts
4 #16 Contacts
4 #5 Coax Contacts

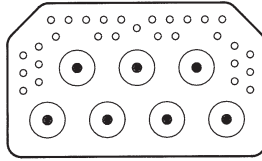

Insert 36C7
29 #22 Contacts
7 #5 Coax Contacts

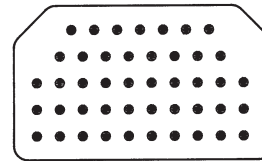

Insert 45
45 #20 Contacts

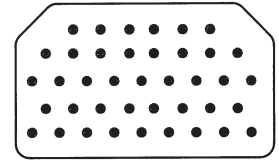

Insert 40
40 #20 Contacts

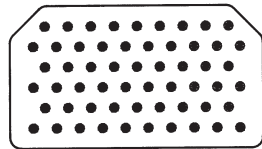

Insert 57
57 #20 Contacts

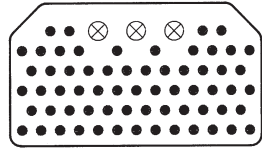

Insert 67
64 #20 Contacts
3 #16 Contacts

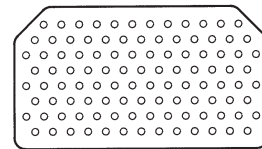

Insert 106
106 #22 Contacts

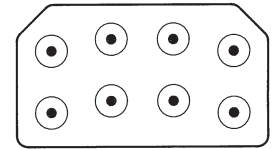

Insert C8
8 #9 Coax Contacts

Note: Consult the factory for other insert patterns.

ARINC 404 and 600 Termination Styles

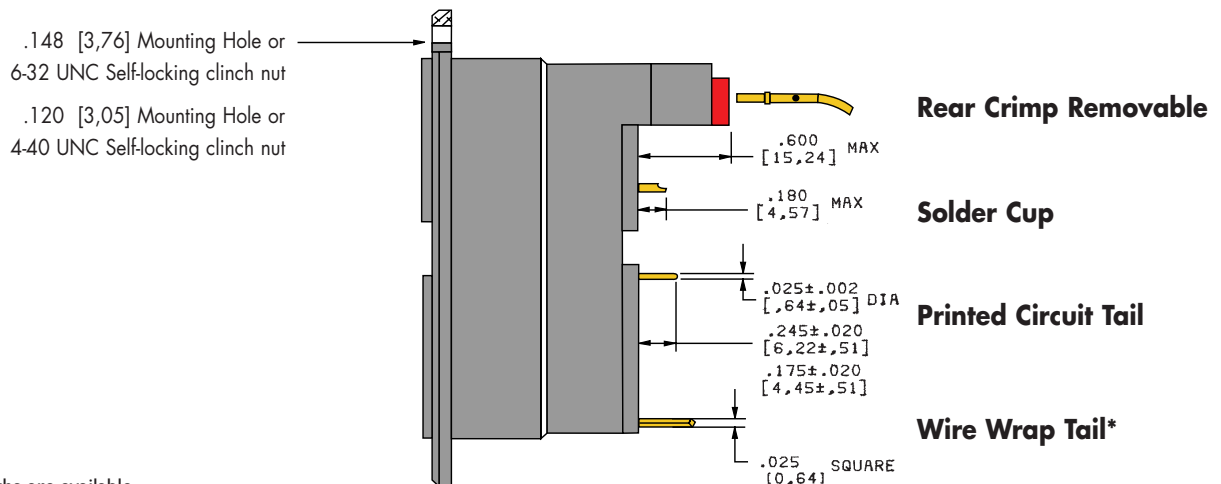

*Various lengths are available. Consult the factory for details.

Transient Suppression for Lightning and EMP Applications

Designing for Lightning Induced Transient Susceptibility

In addition to designing for control of steady state electromagnetic interference (EMI/EMC), modern avionics engineers must also design for the recent advent of much stricter requirements for immunity to lightning induced transient susceptibility. These requirements vary by equipment type and environmental area and are defined by a variety of military and commercial specifications including RTCA/DO-160 C Section 22. The nature of the transient events ranges from very low level disturbances requiring little or no protection, to high frequency and high energy events that can be disruptive or destructive to the avionics equipment.

In general, practices which are good for control of EMI/EMC will also serve to mitigate the effects of lightning induced transients but further measures must often be taken to ensure proper system operation and survivability. One of the more effective methods available is the inclusion of circuit protective devices in the circuit at the input of the LRU. The most common types of devices employed are Zener suppression diodes and metal oxide varistors (MOV's). These non-linear V-I devices conduct very little current at low voltage levels, but once above the breakdown voltage, the voltage across the device remains fairly constant.

Filter Connectors with Transient Suppressors

While conventional EMI filter connectors have been shown to be effective in providing protection against low energy transients, they offer little protection from high voltage/high energy transients that may result from lightning, load switching, electrostatic discharge (ESD) or electromagnetic pulse (EMP). For those applications requiring protection of sensitive circuitry from such over-voltage events, Zener suppression diodes or MOV's can be incorporated into the connector body in combination with EMI filtering or alone. Combining the transient suppression device into the connector

provides several advantages:

- saves space and weight versus placing discrete components onto a PCB
- reduces system design time
- reduces number of components
- improves voltage clamping performance by eliminating parasitic lead resistance and inductance of board level components
- allows for retrofit of existing equipment requiring lightning or EMP hardening
- improves system reparability and maintenance logistics

Amphenol Diode Protected Connectors

The approach employed by Amphenol to incorporate diode protection into the connector body is to install a custom diode/contact assembly into an insert with a ground plate. This design provides for a 600 W device to be installed on each contact in the connector while minimizing the package size and

weight. In the ARINC connector products this design still allows for easy removal and replacement of the front socket contacts. In addition, each diode is individually replaceable at the factory in the event that repair is necessary.



Diode Contact Characteristics

Diode Contact Designation	Breakdown Voltage ⁺ $V_{(BR)}$			Test Current I_T	Rated Stand-off Voltage V_{WM}	Maximum Reverse Leakage Current $I_D @ V_{WM}$	Maximum* Peak Reverse Clamping Voltage $V_C \text{ Max.} @ I_{PP}$	Maximum Peak Pulse Current I_{PP}	Power Capability @ 1 msec Pulse
	Min.	Nom.	Max.						
	V_{DC}	V_{DC}	V_{DC}	mADC	V	μ ADC	V	A	W
485-D0068	6.4	6.8	7.2	10	5.8	1000	10.5	57.0	600
485-D0100	9.5	10.0	10.5	1	8.5	10	14.5	41.0	600
485-D0150	14.3	15.0	15.8	1	12.8	5	21.2	28.0	600
485-D0220	20.9	22.0	23.1	1	18.8	5	30.6	20.0	600
485-D0330	31.4	33.0	34.7	1	28.2	5	45.7	13.2	600
485-D0470	44.7	47.0	49.4	1	40.2	5	64.8	9.3	600
485-D0680	64.6	68.0	71.4	1	58.1	5	92.0	6.5	600
485-D1000	95.0	100.0	105.0	1	85.5	5	137.0	4.4	600
485-D1500	143.0	150.0	158.0	1	128.0	5	207.0	2.9	600
485-D2000	190.0	200.0	210.0	1	171.0	5	274.0	2.2	600

Note: Other diode contacts having different voltage and power capabilities are available. Consult the factory for additional information.

* 10 x 1000 μ sec pulse

+ Available in unidirectional and bidirectional devices

MOV Contact Characteristics

MOV Contact Designation	Maximum Ratings (125°C)					Characteristics (25°C)									
	Continuous		Transient		Maximum Leakage Current at 90% $V_{T(DC)}$	Varistor Voltage @ 1m ADC Test Current			Maximum Clamping Voltage $V_C @$ Test Current (8/20 μ s)		Capacitance (pF) f=1 MHz		Maximum Leakage Current at 90% $V_{T(DC)}$		
	RMS Voltage	DC Voltage	Energy (10/1000 μ s)	Peak Current (8/20 μ s)											
	$V_{M(AC)}$ Volts	$V_{M(DC)}$ Volts	W_{TM} Joules	I_{TM} Amperes	$I_L \text{ Max}$ μ A	Min. Volts	$V_{N(DC)}$ Volts	Max. Volts	V_C Volts	I_P Amps	Min.	Max.	$I_L \text{ Max}$ μ A	$V_{T(DC)}$ Volts	
485-M-0160	6.0	8.0	1.5	250	50	12.5	16.0	19.5	34.0	10	1600	2750	5.0	8	
485-M-0220	10.0	14.0	1.5	250	50	18.5	22.0	25.5	42.0	10	1600	2750	5.0	14	
485-M-0390	25.0	31.0	1.5	250	50	35.0	39.0	43.0	85.0	5	450	1350	5.0	28	
485-M-0470	30.0	38.0	1.5	250	50	42.0	47.0	52.0	100.0	5	450	1250	5.0	36	
485-M-2000	130.0	130.0	2.4	300	100	184.0	200.0	228.0	375.0	5	150	350	5.0	130	
485-M-2400	150.0	150.0	2.4	300	100	212.0	240.0	268.0	430.0	5	100	350	5.0	150	

Note: Values are for size 22 contacts. Other MOV contacts are available. Consult the factory for additional information.

Filter/Diode Connector Transient Response

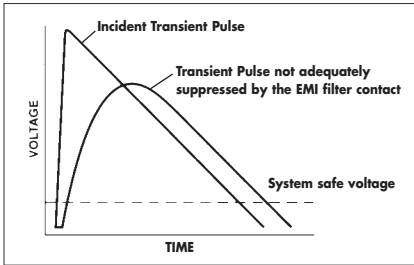

EMI Filter

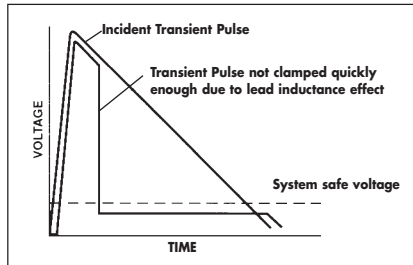

PCB mounted Diode or MOV

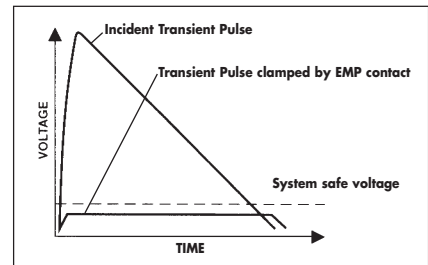

Contact/Connector Diode or MOV

Termination Module

A termination module is a removable extension of the connector which is recommended for use with ARINC connectors which have transient suppression devices. The engagement side of the termination module is designed to mate to the rear of the connector and the termination end is designed to attach to the PCB or wire harness (PC tails, solder-cups, wire-wrap or crimp). Proper engagement of the connector and termination module is guaranteed by guide posts in the connector and front or rear activated jack screws. Sealing is accomplished with a rubber interfacial gasket.

Connectors designed to engage to a termination module are designed with one-piece front removable socket contacts to minimize the number of interconnects.

The use of a termination module provides several advantages:

- simplifies the assembly process by soldering to the lighter weight termination module rather than to the connector itself
- facilitates repair and rework procedures due to easy installation and removal from the motherboard

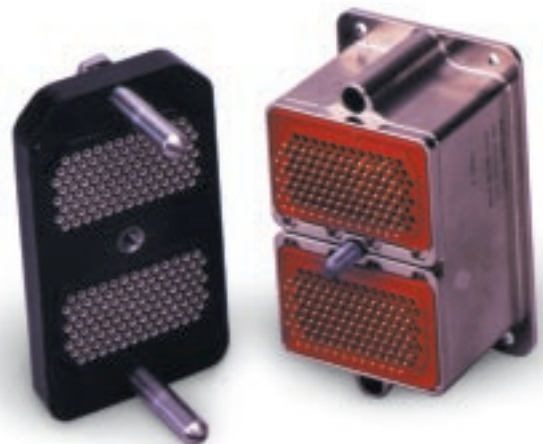
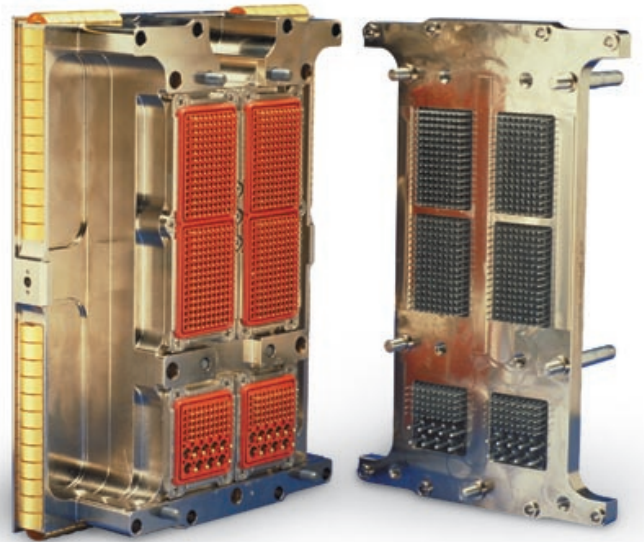

ARINC Accessories

ARINC replacement contacts can be ordered separately if required. Additional accessories such as EMI backshells and fibre optic contacts are also available. Contact the factory for details.

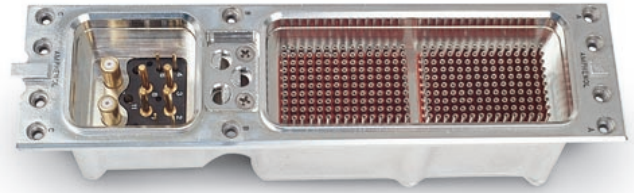

ARINC 600

Contact Size	Contact P/N	Insertion/Removal tool	Crimp tool	Positioner
#22 socket	485-1034*	485-905	N/A	N/A
#22 crimp termination	485-6222	M81969/1-01	M22520/2-01 or M22520/7-01	M22520/2-06 or M22520/7-06
#20 pin+	485-120	M81969/1-02 or M81969/14-10	M22520/2-01	M22520/2-08
#16 pin+	485-116	M81969/1-03 or M81969/14-03	M22520/1-01	M22520/1-02
#12 pin+	485-112	M81969/14-04	M22520/1-01	M22520/1-11

ARINC 404

Contact Size	Contact P/N	Insertion/Removal tool	Crimp tool	Positioner
#22 socket	485-1236*	485-905	N/A	N/A
#22 crimp termination	485-4222	M81969/1-01	M22520/2-01 or M22520/7-01	M22520/2-06 or M22520/7-06

* Some connectors have custom socket contacts. Consult the factory for details.

+ Cavity C or F contacts

485 Series Part Numbering Information

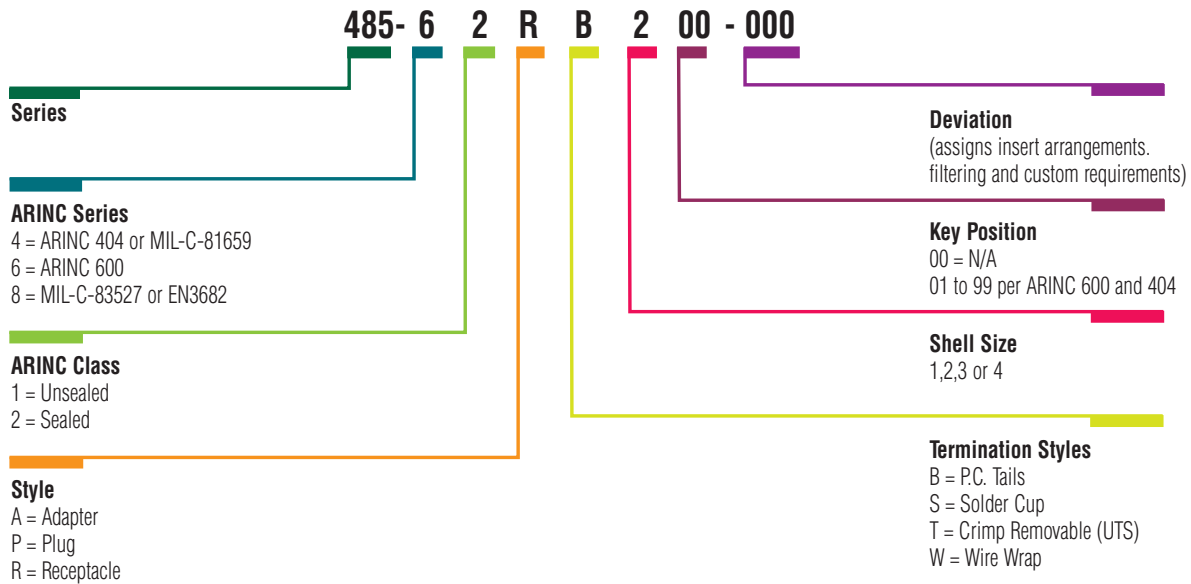

MIL-C-24308 Style (D-Sub) Filter Connectors

Amphenol offers a variety of filtered D-Sub connectors to address aerospace and commercial EMI requirements. There are two products in particular which are designed for aerospace applications where high reliability and superior environmental and electrical performance are required. The 481 series of filtered D-Sub connectors has been in production for over 20 years using tubular capacitor filter technology. In the late 1980's, Amphenol developed a planar filter

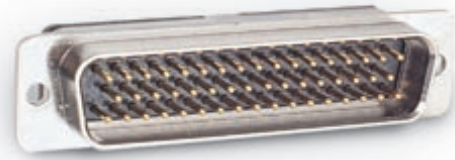

capacitor version of the same connector, the 308 series. As a result, Amphenol has the widest product offering in the industry and can provide either technology as the application and production requirements dictate.

308 Series – Planar Capacitor Technology

- superior pin-pin cross talk isolation
- cost effective for small quantities
- can accommodate a wider range of capacitance values than planar designs
- fully tooled in medium density pin and selected socket and high density arrangements
- short production leadtimes
- solderless stress-isolated construction (see page 23 for details)

Quality Conformance Inspection

The 308 series connectors have been extensively qualified per the requirements of MIL-C-24308. All products shipped receive the following inspection tests:

- 100% visual and mechanical inspection
- 100% capacitance, dielectric withstanding voltage, insulation resistance and dissipation factor testing
- sample insertion loss testing (AQL 1.0%)

For high reliability applications, the following inspection tests or certifications are also available:

- thermal shock
- elevated temperature voltage conditioning
- elevated temperature insulation resistance and capacitance
- outgassing per JSC-SPR-0022 for space borne applications
- baseline and single lot date code manufacturing
- other tests as required (consult the factory)

308 Special



Filtered D-Sub programmable



EMI Grounded Special



Zinc Nickel Plating

Environmentally friendly, conductive and able to withstand up to 2000 hours of salt spray per ASTM-B117

Please consult factory for any custom arrangements

Planar D-Sub Filter Connector Construction and Material Specifications

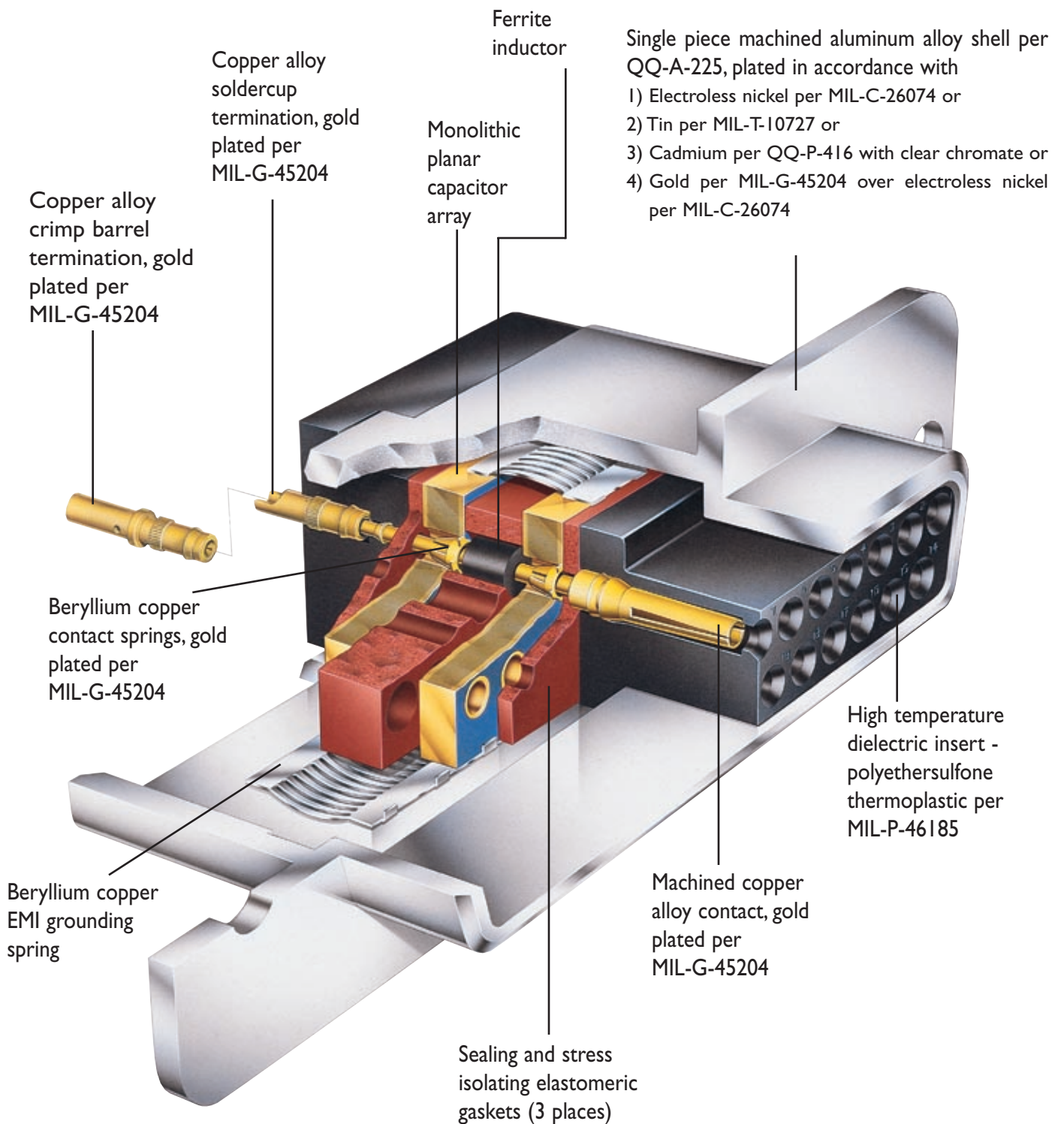

308 Series Electrical Characteristics

Filter Circuit	PI					C, CLR, LRC, T					
Filter Type	PA4	P02	P04	P08	P16	CA2	C01	C02	C04	C22 [†]	C50 [†]
Capacitance (pF) (@ 25°C, 1kHz & 1.0VRMS)	400 to 800	1800 to 3600	4000 to 8000	8000 to 16000	16000 to 32000	200 to 400	900 to 1800	1800 to 3600	4000 to 8000	22000 to 40000	50000 to 100000
Insertion Loss (dB min.) (per MIL-STD-220 at 25°C & no load)	.1 MHz	–	–	–	–	–	–	–	–	–	3
	1 MHz	–	–	2	5	8	–	–	–	10	15
	10 MHz	2	10	15	18	28	–	4	8	13	26
	100 MHz	20	38	50	55	62	10	20	25	33	45
	1000 MHz	58	60	60	63	68	25	35	40	50	50
Working Voltage (VDC) (@ 25°C & sea level)	200									100	
Dielectric Withstanding Voltage (VDC) (@ 25°C & 50 mA max. charging current)	500									300	
Insulation Resistance (Gohms) (@ 25°C & working voltage)	10										
Contact Current Rating (continuous max., DC amperes)	5										
Filter RF Current Rating (amperes) (max. @ any frequency)	3										

Note: Other capacitance values, mixed capacitance arrangements, ground and insulated contacts are available. Consult the factory for your particular application.

† Not available in high density arrangements

Typical Insertion Loss Performance

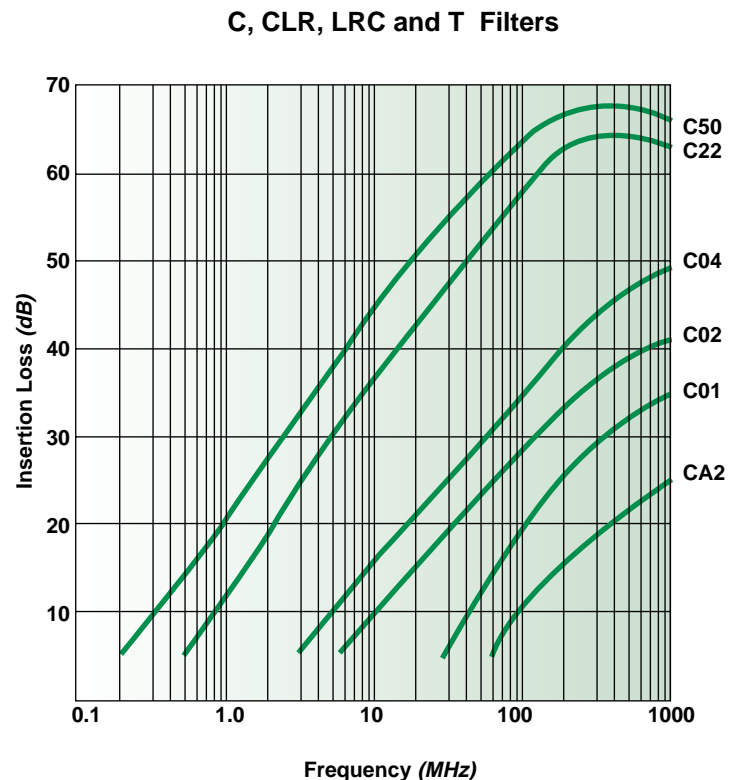
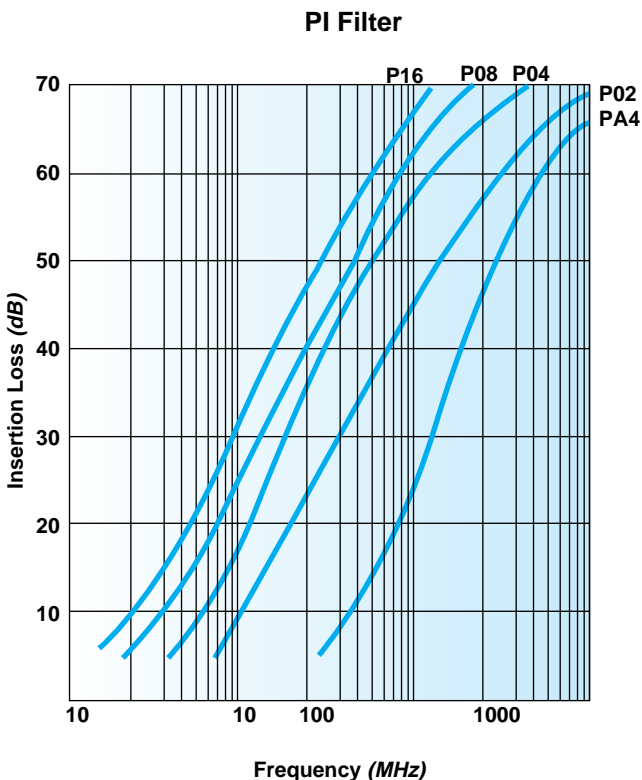

308 Series Plug Dimensions

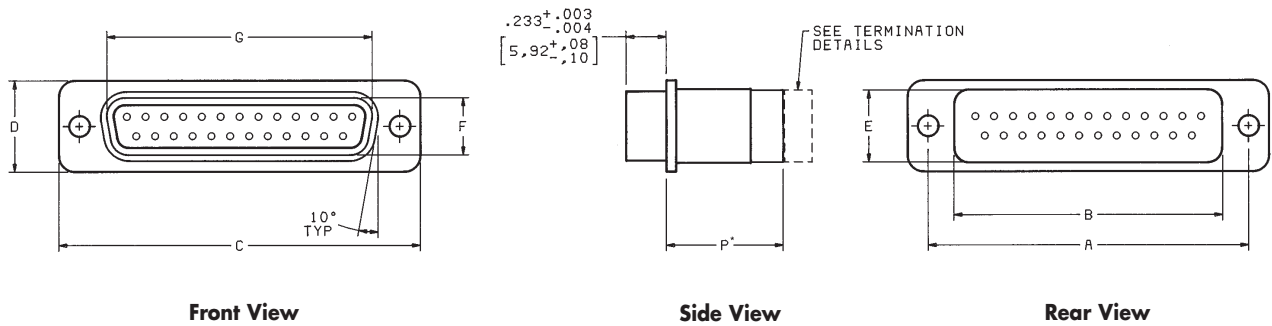

Shell Size	Number of Contacts	Dimension													
		A		B Max		C		D Max		E Max		F		G	
		±.005"	±.13mm	inches	mm	±.015"	±.38mm	inches	mm	inches	mm	±.005"	±.13mm	±.005"	±.13mm
E	9 or 15	0.984	24,99	0.685	17,34	1.213	30,81	0.534	13,56	0.434	11,02	0.329	8,36	0.666	16,92
A	15 or 26	1.312	33,32	1.009	25,63	1.541	39,14	0.534	13,56	0.434	11,02	0.329	8,36	0.994	25,25
B	25 or 44	1.852	47,04	1.557	39,55	2.088	53,04	0.534	13,56	0.434	11,02	0.329	8,36	1.534	38,96
C	37 or 62	2.500	63,50	2.205	56,01	2.729	69,32	0.534	13,56	0.434	11,02	0.329	8,36	2.182	55,42
D	50 or 78	2.406	61,11	2.110	53,59	2.635	66,93	0.641	16,28	0.541	13,74	0.441	11,20	2.079	52,81
6	104	2.500	63,50	2.255	57,28	2.729	69,32	0.680	17,27	0.640	16,26	0.503	12,77	2.212	56,18

* For Dimension P, see page 21

308 Series Receptacle Dimensions

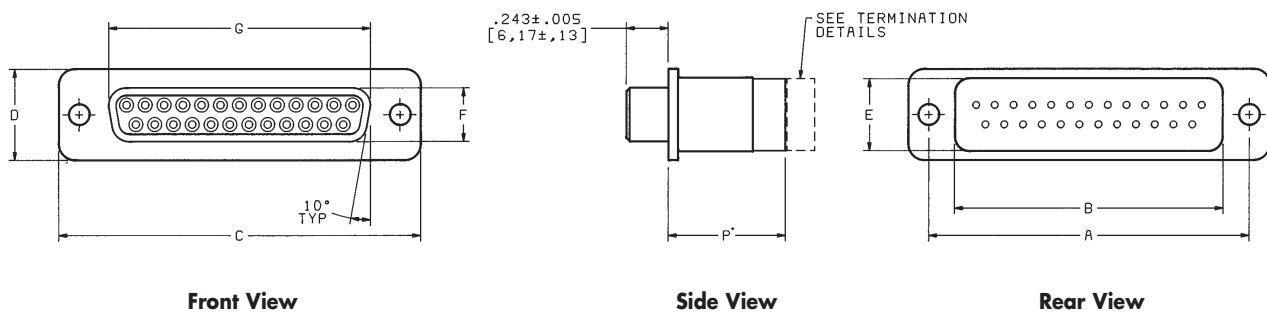

Shell Size	Number of Contacts	Dimension													
		A		B Max		C		D Max		E Max		F		G	
		±.005"	±.13mm	inches	mm	±.015"	±.38mm	inches	mm	inches	mm	±.005"	±.13mm	±.005"	±.13mm
E	9 or 15	0.984	24,99	0.685	17,34	1.213	30,81	0.534	13,56	0.434	11,02	0.311	7,90	0.643	16,33
A	15 or 26	1.312	33,32	1.009	25,63	1.541	39,14	0.534	13,56	0.434	11,02	0.311	7,90	0.971	24,66
B	25 or 44	1.852	47,04	1.557	39,55	2.088	53,04	0.534	13,56	0.434	11,02	0.311	7,90	1.511	38,38
C	37 or 62	2.500	63,50	2.205	56,01	2.729	69,32	0.534	13,56	0.434	11,02	0.311	7,90	2.159	54,84
D	50 or 78	2.406	61,11	2.110	53,59	2.635	66,93	0.641	16,28	0.541	13,74	0.423	10,74	2.064	52,43
6	104	2.500	63,50	2.255	57,28	2.729	69,32	0.680	17,27	0.640	16,26	0.485	12,32	2.189	55,60

* For Dimension P, see page 21

308 Series Termination Styles

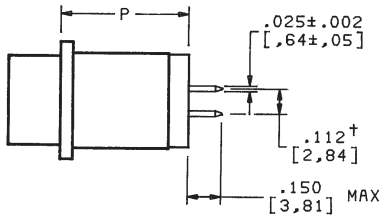

Termination Style 1

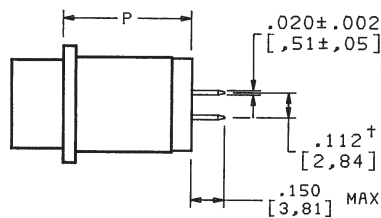

Termination Style 2

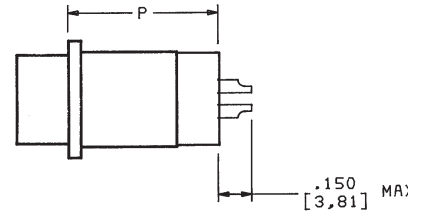

Termination Style 3

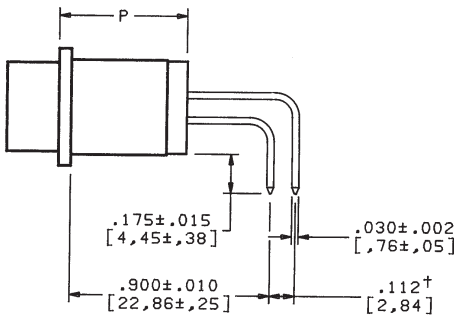

Termination Style 4

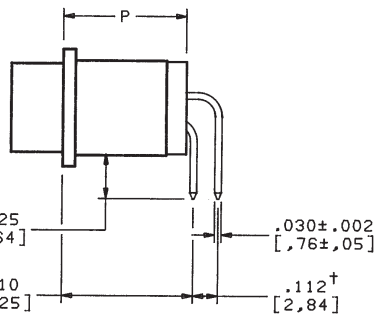

Termination Style 6

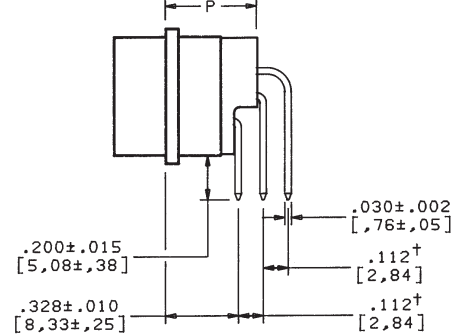

Termination Style 7

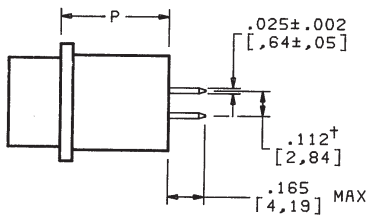

Termination Style 8

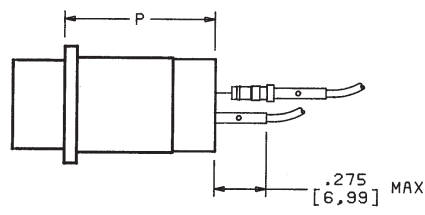

Termination Style 9

† This dimension is 0.078" (1.98) for high density arrangements

Filter Circuit	Termination Style and Shell Length (P Max dimension)													
	1 and 2		3		4		6		7		8		9	
	inches	mm	inches	mm	inches	mm	inches	mm	inches	mm	inches	mm	inches	mm
PI,LRC,CLR,T	0.575	14,61	0.695	17,65	0.575	14,61	0.575	14,61	N/A	N/A	0.470	11,94	0.695	17,65
C	0.450	11,43	0.570	14,48	0.450	11,43	0.450	11,43	0.400	10,16	0.370	9,40	0.570	14,48

308 Series Mounting Styles

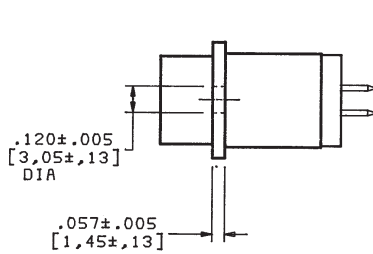

Mounting Style 1

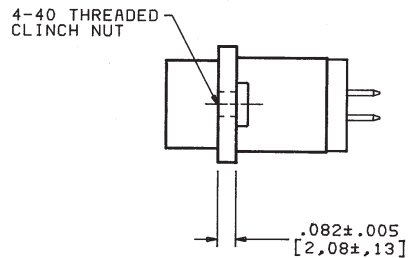

Mounting Style 2

308 Series Insert Arrangements

Pin Engaging Face Shown

Shell Size 1 (E)

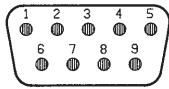

9 #20 Contacts

Shell Size 2 (A)

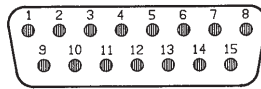

15 #20 Contacts

Shell Size 3 (B)

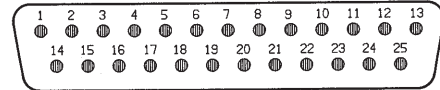

25 #20 Contacts

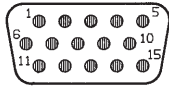

15 #22 Contacts

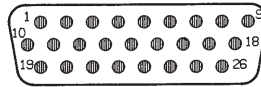

26 #22 Contacts

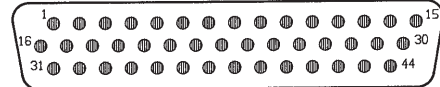

44 #22 Contacts

Shell Size 4 (C)

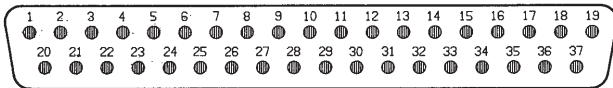

37 #20 Contacts

Shell Size 5 (D)

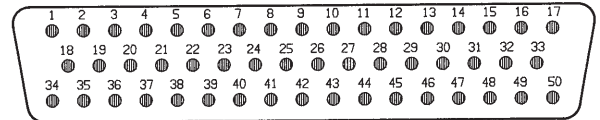

50 #20 Contacts

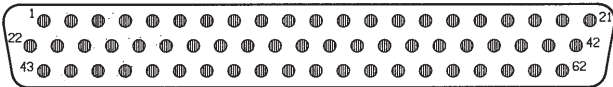

62 #22 Contacts

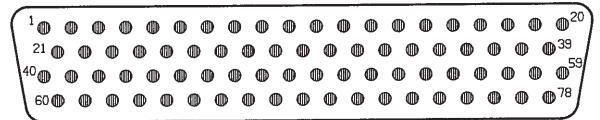

78 #22 Contacts

Shell Size 6

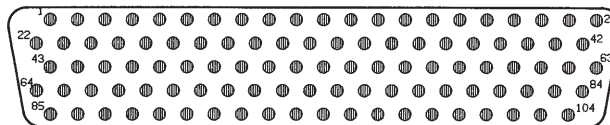

104 #22 Contacts

Note: Consult the factory for other insert patterns.

Recommended Panel Cutout

Front and Rear Mounting

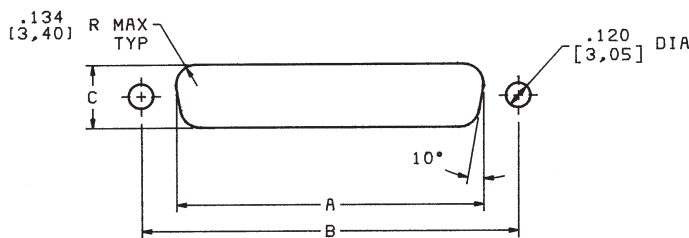

Shell Size	Dimension					
	A min		B		C min	
	inches	mm	±.005"	±.13mm	inches	mm
1 (E)	0.801	20,35	0.984	24,99	0.449	11,40
2 (A)	1.129	28,68	1.312	33,32	0.449	11,40
3 (B)	1.669	42,39	1.852	47,04	0.449	11,40
4 (C)	2.321	58,95	2.500	63,50	0.449	11,40
5 (D)*	2.213	56,21	2.406	61,11	0.555	14,09
5 (D) ⁺	2.250	57,15	2.406	61,11	0.585	14,86
6 *	2.360	59,94	2.500	63,50	0.630	16,00

* Rear mounting dimensions

⁺ Front mounting dimensions

FX Series

Filter Terminal Blocks, Discrete Filters and Specials

DESCRIPTION



Amphenol's FX series of Discrete Feed-thru Filters offer excellent, low cost filter solutions for telecom, industrial, military and aerospace electronics applications, especially where small size and high performance are important.

Manufactured to meet the requirements of Mil-F-15733, the FX filters are available in threaded bushing and solder-mount styles with capacitance ranges from 10pF to 600nF.

Due to Amphenol's unique manufacturing process, higher capacitance values and greater voltage withstand capabilities are achieved with the same industry standard package sizes.

Consult factory for custom filter and/or filter plate requirements.

MATERIALS

Terminals: Copper Alloy, silver plated (filter pins shown are gold plated)

Eyelets/Bushings: Brass, silver plated

ORDERING INFORMATION

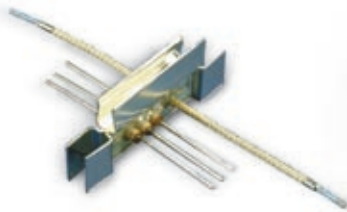
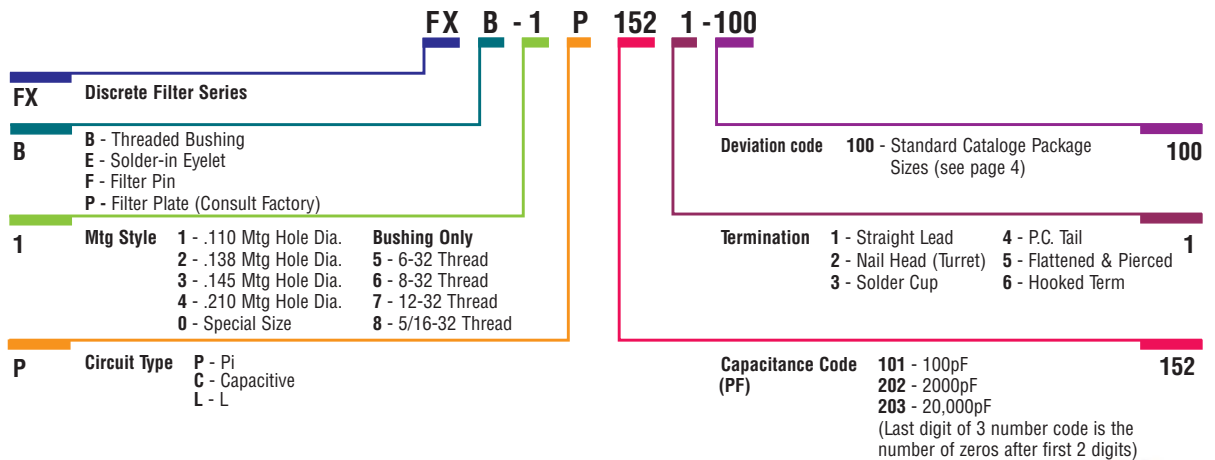

Coax Filter Plate Assembly



Filtered Terminal Block

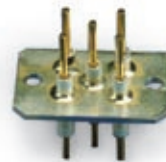

Filter Plate Assembly



Special Filter Plate Shell Assembly

For EMI/EMP Protection, Look to the Leader - Amphenol Aerospace



Amphenol Aerospace, the Interconnection Leader, offers advanced EMI/EMP Protection with high reliability. The proven performance of Amphenol® EMI Filter/Transient Protection Connectors means dependable protection for the costly and sensitive circuitry in sophisticated avionics.

Each circuit of the filter connector is individually filtered and internally housed in the connector, eliminating the need for costly and bulky exterior discrete protection devices. Amphenol Filter connectors are intermateable and intermountable with MIL-C-38999, MIL-C-27599, MIL-C-83723, MIL-C-26482, MIL-C-24308, MIL-C-5015.

Amphenol offers a broad range of cost saving filter options with versatility in sizes, styles and arrangements.



EMI Programmable Connectors

An alternative to non-removable filter contacts. Crimp style EMI contacts are insertable and removable from the rear of the connector. Allows the user to run diagnostic EMI evaluations of systems before going into production, easily modifying circuitry and pinouts at the test bench level. Available in a wide range of capacitance values in both Pi and C type filters, crimp and PC termination styles.



EMI/EMP Adapters

Provide cost effective solutions to problems on existing applications. Designed to be installed between the existing cable plug and unit receptacle. Circuit protection at MF, HF, VHF, and UHF levels is available in contact sizes 22 to 12 with all the popular Mil-specs.



Header Assemblies

For time and cost savings. Can be vapor phase or wave soldered to flex or printed circuit boards prior to the receipt of an EMI/EMP connector. Expensive connector assemblies can be easily removed from and reattached to the header assembly as the manufacturing process dictates. Available to fit all major cylindrical Mil-spec connectors.

Contact us for your special application requirements: Amphenol Aerospace, 40-60 Delaware Ave., Sidney, NY 13838-1395
Phone: 607-563-5011 Fax: 607-563-5157 Web Site: www.Amphenol-Aerospace.com

Amphenol Canada
20 Melford Drive
Scarborough, ON
Canada M1B 2X6
Phone: 416-291-4401
Fax: 416-292-0647

Amphenol Aerospace
40-60 Delaware Avenue
Sidney, NY 138 38-1395
Phone: (607) 563-5453
Fax: (607) 563-5351

Amphenol Aerospace
22952 Alcade Drive
Suite 110
Laguna Hills, CA 92653
Phone: (949) 855-4454
Fax: (949) 855-9115

Amphenol Aerospace
57 E. Hattendorf Avenue
Suite 150
Roselle, IL 60172
Phone: (630) 893-1713
Fax: (603) 893-3958

Amphenol Aerospace
7506 East Independence Blvd.
Charlotte, NC 28227
Phone: (704) 531-9053
Fax: (704) 531-9054

Communication and Network
Products Division
One Kennedy Avenue
Danbury, CT 06810
Phone: (203) 743-9272

Fiber Optic Products
1925A Ohio Street
Lisle, IL 60532
Phone: (630) 960-1010

Sine Systems * Pyle Connectors
Corporation
25325 Joy Boulevard
Mt. Clemens, MI 48046
Phone: (810) 465-3131

Chicago Office
650 W. Grand Avenue, Suite 304
Elmhurst, IL 60126
Phone: (630) 832-4600

Spectra Strip
720 Sherman Avenue
Hamden, CT 06514
Phone: (203) 281-3200

Technical Products International
2110 Notre Dame Avenue
Winnipeg, MB, R3H 0K1 Canada
Phone: (204) 697-2222

Times Fiber Communications, Inc.
358 Hall Avenue
Wallingford, CT 06492
Phone: (203) 265-8500
Amphenol Mexico
Presidente Masaryk 61, Piso 2
C.P. 11570 Mexico D.F.
Mexico
Phone: (52-5) 254-7283
Fax: (52-5) 531-9659

Advanced Circuit Technology
118 Northeastern Boulevard
Nashua, NH 03062
Phone: (603) 880-6000

Amphenol Scandinavia
P.O. Box 2047
Johannelundsvagen 2
194 02 Upplands Vaesby
Sweden
Phone: 46-8-594-10440

Amphenol Socapex S.A.S.
Promenade de l'Arve, BP 29
74311 Thyez Cedex
France
Phone: 33-4-5089-2800

Amphenol-TFC (Changzhou)
Communications Equipment Co., Ltd.
96 Hehai Road, Changzhou New &
HighTech & Industrial
Development Zone
Changzhou 213000, Jiangsu, PRC
Phone: 86-519-510-6004

Amphenol Taiwan
59, Lung-Shou Street, Sec. 1
Lu-Chu-Hsiang, Taoyuan Hsien
Taiwan
Republic of China
Phone: 886-3-379-5677

Amphenol-Tuchel Electronics GmbH
August-Haeusser-Strasse 10
74080 Heilbronn
Germany
Phone: 49-7131-929-0

Amphetronix Limited
P.O. Box No. 1, Plot No. 105
105 Bhosari Industrial Area
Pune 411026, India
Phone: 91-20-790363

Israel
Bar-Tec Ltd.
11 Barliam St., P.O. Box 279
Kfar Saba 44102
Israel
Phone: (972-9) 974097
Fax: (972-9) 974324

Amphenol Australia Limited
2 Fiveways Blvd., Keysboroug
Victoria 3173, Melbourne, Australia
Phone: 61-3-8796-8888

Amphenol European Sales Operations
Hoofdveste 19
3992 DH
The Netherlands
Phone: 31-30-635-8001

Amphenol Dae Shin Limited
#182-1 Dodan-Dong, Wonmi-ku
Bucheon-City, Kyungki-Do
Korea
Phone: 82-32-680-3800

Amphenol do Brasil LTDA
Morumbi Tower
Avenida Roque Petroni Junior 999
13th Floor CEP 04707-910
Sao Paulo, Brazil
Phone: 55-11-5185-2881

Amphenol East Asia Limited
10/F Wah Luen Industrial Centre
15-21 Wong Chuk Yeung Street
Fotan, Hong Kong
Phone: 852-2669-2663

Amphenol Espana
Calle Cuba No. 6, 2-5
28820 Coslada Madrid
Spain
Phone: 349-1-673-2235

Amphenol Gesellschaft mbH
Johnstrasse 42
2 Stoch, Top 3A
Vienna, Austria
Phone: 43-1-985-1511

Amphenol Interconnect
Products Corporation
20 Valley Street
Endicott, NY 13760
Phone: (607) 754-4444

Amphenol Italia, S.P.A.
Galleria Gandhi, 2-27
20017 - Mazzo di Rho (Milano)
Italy
Phone: (390-2) 939-04192
Fax: (390-2) 935-03206
Telex: 334623 AMPHIT I

Amphenol Japan, K.K.
2-3-27, Kudan Minami
Chiyoda-ku, Tokyo 102
Japan
Phone: 81-3-3263-5611

Amphenol Limited
Thanet Way
Whitstable, Kent
England CT5 3JF
Phone: 44-1227-773-200

Amphenol Ges mbH
Tautenhayngasse 22
A-1150 Wien (Vienna)
Austria
Phone: (43-1) 985-15-11
Fax: (43-1) 982-61-01
Telex: (847) 132661 AMPHWA

Amphenol East Asia, Ltd.
80 Genting Lane
09-04 Genting Block
Ruby Industrial Complex
Singapore 1334
Phone: (65) 7433022
Fax: (65) 7432466
Telex: RS 23499 AMPHNL

Amphenol
Amphenol Canada Corp.

20 Melford Drive, Scarborough, Ontario, Canada M1B 2X6
Telephone (416) 291-4401 Fax (416) 292-0647

Notice: Specifications are subject to change without notice. Contact your nearest Amphenol sales office for the latest specifications. All statements, information and data given herein are believed to be accurate and reliable but are presented without guaranty, warranty, or responsibility of any kind, express or implied. Statements or suggestions concerning possible use of our products are made without representation or warranty that any such use is free of patent infringement, and are not recommended to infringe any patent. The user should not assume that all safety measures are indicated or that other measures may not be required. Amphenol is a registered trademark.

X-ON Electronics

Largest Supplier of Electrical and Electronic Components

Click to view similar products for [Rack & Panel Connectors](#) category:

Click to view products by [Amphenol](#) manufacturer:

Other Similar products are found below :

[00170420102](#) [00171420202](#) [00171440002](#) [008026165000265](#) [00-8219-072-000-112P44](#) [008219072000112P5](#) [02-014-013-5200-000](#) [613467-000](#) [CTJ112E01E-513](#) [CTJ116E03A-513](#) [M81714/63-22S L/C](#) [M81714/65-12-1](#) [66020-2](#) [CW8958-000](#) [699886-000](#) [D250-50632](#)
[70.400.3240.0](#) [70.955.2453.3](#) [733753-000](#) [F22831-000](#) [780-522-DPX34RG8-02](#) [MMA25-0341D1](#) [8660-501](#) [87.060.0053.0](#) [900709N001](#)
[QRP4-12P-C\(01\)](#) [QR/P6-6S-C\(01\)](#) [AC-600003-004](#) [1218600-1](#) [D-659-0061](#) [DMC-MD 24 C-T](#) [1-445717-6](#) [1484398-2](#) [1484399-2](#) [1484469-2](#) [MR-34MG](#) [1484225-1](#) [1484398-1](#) [1604997-2](#) [1663130-1](#) [1663767-7](#) [1663767-8](#) [MTC100-BF1-P31CS015](#) [MTC100-KT2-0083](#) [MTC100-KT2-0123-003](#) [MTC100-YA1-005](#) [MTCB1X-105-XXX](#) [MTCPQKT1P2PGDC](#) [MTCPQKT1R2PGCA](#) [MTCR-103-04S](#)