

PRODUCT NUMBER
54201 - X XX - XX - XXX

PLATING
S=15μ"/0.38μm GOLD ON CONTACT AREA (NOTE 13) 100u"/2.54μm TIN ON TAIL
G=30μ"/0.76μm GOLD ON CONTACT AREA (NOTE 13) 100u"/2.54μm TIN ON TAIL
T=100μ"/2.54μm TIN ON CONTACT AREA & ON TAIL (SEE NOTE 8 & 12)
F=2μ"/0.05μm] GOLD ON CONTACT AREA & ON TAIL

POLARIZATION, SEE NOTE 6
PACKAGING TYPE, NOTE 5
POSITIONS PER ROW
02 TO 17

LEAD STYLE	POST LGTH.
08	0.230/5.84
30	0.318/8.08

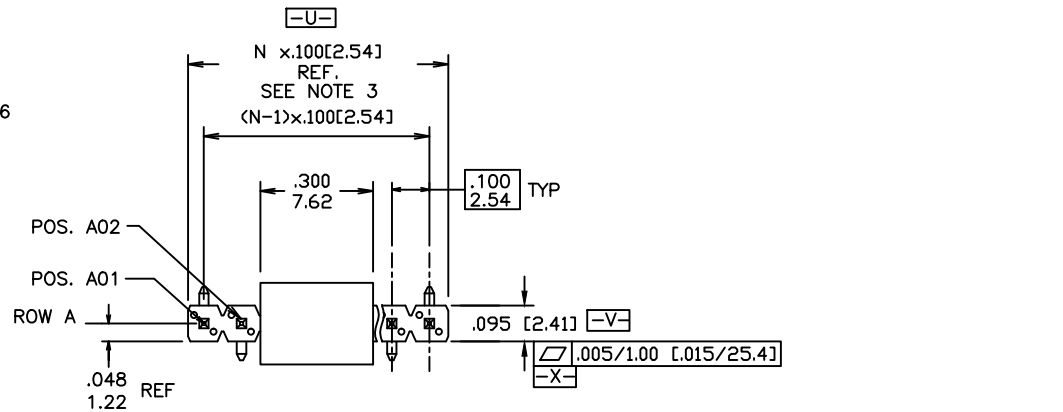

LEAD FREE PRODUCT NUMBER
54201 - X XX XX - XXX LF

PLATING
S=15μ"/0.38μm GOLD ON CONTACT AREA (NOTE 13) 100u"/2.54μm TIN ON TAIL
G=30μ"/0.76μm GOLD ON CONTACT AREA (NOTE 13) 100u"/2.54μm TIN ON TAIL
T=100μ"/2.54μm TIN ON CONTACT AREA & ON TAIL (SEE NOTE 8 & 12)
F=2μ"/0.05μm] GOLD ON CONTACT AREA & ON TAIL

LEAD FREE NOTE 9 & 10
POLARIZATION, SEE NOTE 6
PACKAGING TYPE, NOTE 5
POSITIONS PER ROW
02 TO 17

LEAD STYLE	POST LGTH.
08	0.230/5.84
30	0.318/8.08

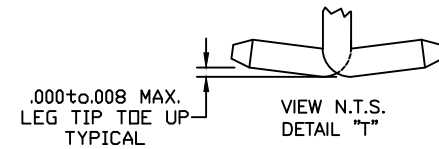
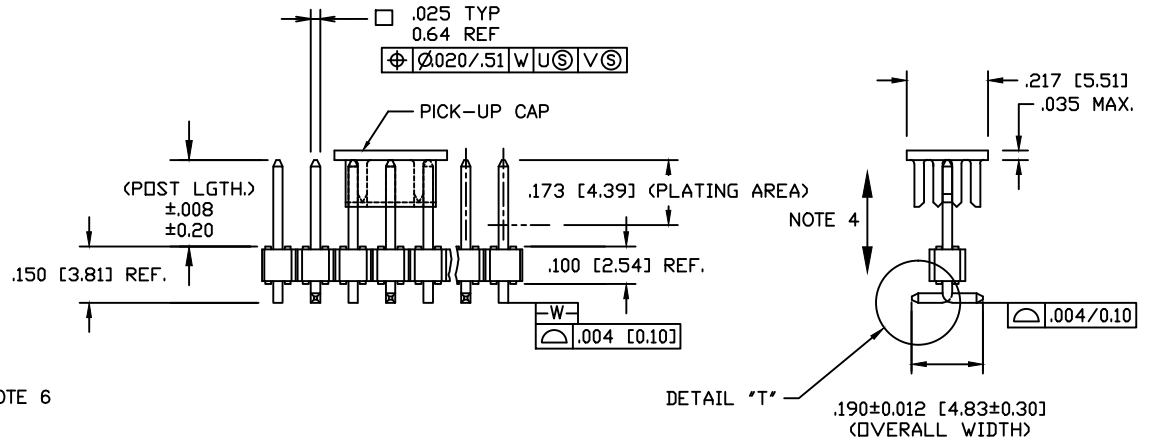

mat'l. code SEE NOTES 1 & 2		surface ISO 1302 ✓		tolerance ISO 406 ISO 1101		projection INCH/MM		product family BERGSTIK	
ltr ecn no dr date		tolerances unless otherwise specified		angles		linear		title	
S ELX-N-14294 DCS 2013-03-19		.XX±.01/.X±0.3		0°±2'		.XXX±.005/.XXX±0.13		.100 UNSHROUDED HDR. S/R VERT. SURF. MNT.	
L M07-0192 MHT 4/18/07		.XXX±.0020/.XXX±0.05				scale 1:1		dwg no sheet 1 of 3 size	
M M08-0129 MHT 4/30/08		dr		D.INGRAM 05/11/99		FCI		54201 A3	
N M08-0165 MHT 6/06/08		enr		H.SUNDY 07/21/99					
P M08-0237 MHT 8/25/08		chr		H.SUNDY 07/21/99					
R M08-0279 MHT 9/30/08		appd		H.SUNDY 07/21/99					
sheet revision		S S S							
index sheet		1 2 3							

TAPE AND REEL PACKAGING

SIZE	LEAD STYLE 08 POST (0.230 [5.84])	LEAD STYLE 30 POST (0.318 [8.08])
1X2	YES	NONE
1X3	↑	↑
1X4		
1X5		
1X6		
1X7		
1X8		
1X9		
1X10		
1X11		
1X12		
1X13		
1X14		
1X15		
1X16	↓	
1X17	YES	
1X18	NONE	
1X19	NONE	↓
1X20	NONE	NONE

NOTES:

- HOUSING MAT'L: HIGH TEMPERATURE THERMOPLASTIC. UL94V-0
COLOR: BLACK
OR
MINERAL FILLED LCP FLAME RETARDENT
PER UL-94V-0. COLOR: BLACK.
- PIN MATERIAL: PHOSPHOR-BRONZE
- TO DETERMINE DIMENSIONS:
N = NUMBER OF POSITIONS PER ROW.
EXAMPLE: 10 POS., N x .100/2.54=1.00/25.4
- 2LBS/0.9KG MIN. PIN RETENTION IN EITHER DIRECTION.
- PACKAGING: - = POLY BAGS
P = TUBES WITH PICKUP CAPS.
A = TAPE AND REEL WITH PICKUP CAPS.
- FOR POLARIZATION, SPECIFY POSITION NUMBER (i.e. A03=ROW A POS. 3)
TO OMIT PIN. IF THIS FEATURE IS NOT APPLICABLE, OMIT FROM PROD. NO..
PRODUCT MANAGEMENT APPROVAL IS REQUIRED PRIOR TO THE
RELEASE OR SALE OF POLARIZED PRODUCTS.
- UNDERPLATING: 50μ"/1.27μm Ni.
- PIN TIPS ON Sn PLATED PRODUCT MAY HAVE BARE METAL ON TOW SIDES,
BOTH ENDS.
- PART NUMBERS WITH "LF" AT THE END ARE LEAD FREE.
- THIS PRODUCT MEETS EUROPEAN UNION DIRECTIVES AND OTHER
COUNTRY REGULATION AS DESCRIBED IN GS-22-008.
- THE HOUSING WILL WITHSTAND EXPOSURE TO 260°C PEAK TEMPERATURE
FOR 20 SECONDS IN A CONVECTION, INFRA-RED OR VAPOR PHASE REFLOW
OVEN. SEE APPLICATION NOTES/PROCEDURES IF THEY ARE AVAILABLE.
- "THIS PRODUCT HAS 100% PURE TIN PLATING IN THE INTERFACE AND
HAS NOT BEEN TESTED FOR WHISKER GROWTH IN ALL INTERCONNECT
ENVIRONMENTS."
- PLATING OPTIONS:
MAY BE EITHER GOLD OR GXT PLATED AT MANUFACTURER'S OPTION.

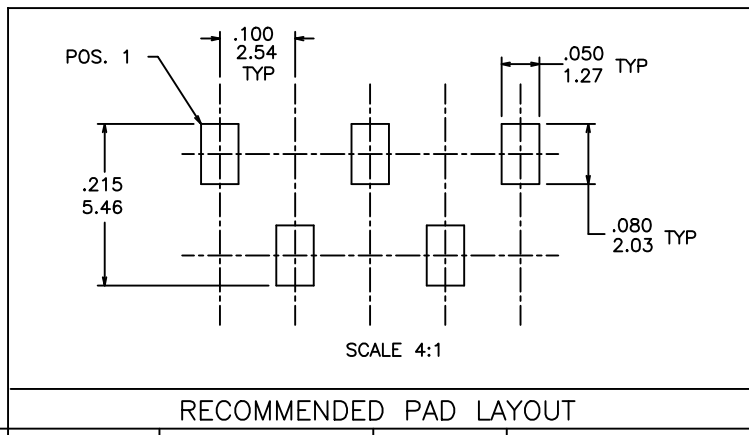

mat'l. code		surface ISO 1302	tolerance ISO 406 ISO 1101	projection 	product family BERGSTIK
ltr	ecn no	dr	date	tolerances unless otherwise specified	title
S				linear XXX±.01/XXX.03 XXX±.005/XXX±0.13 XXX±.0020/XXX±0.05	.100 UNSHROUDED HDR. S/R VERT. SURF. MNT.
				0°±2'	scale 1:1
		dr	D.INGRAM	05/11/99	dwg no
		enr	H.SUNDY	07/21/99	sheet 2 of 3 size
		chr	H.SUNDY	07/21/99	54201 A3
		appd	H.SUNDY	07/21/99	type Product Customer Drawing
sheet index	revision sheet				

CARRIER FOR ODD NUMBERS OF ROWS

CARRIER FOR EVEN NUMBERS OF ROWS

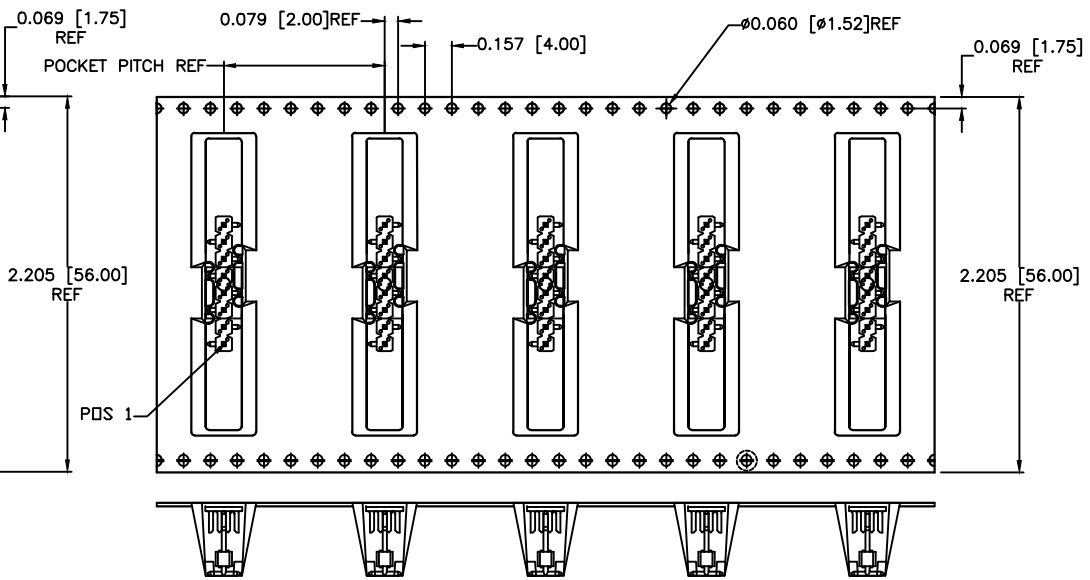
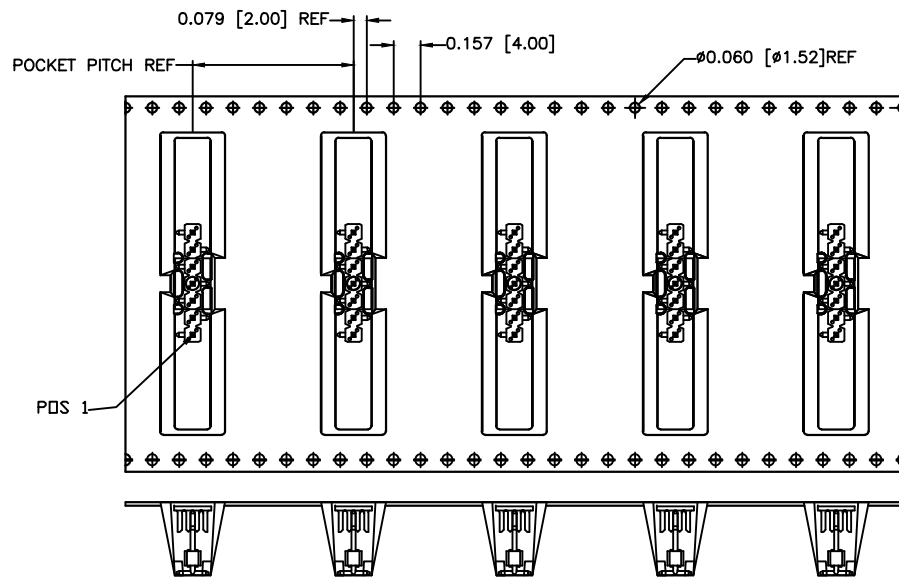

UN-REELING DIRECTION OF FEED

UN-REELING DIRECTION OF FEED

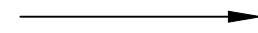
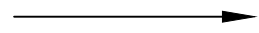

Copyright FCI

mat'l. code		surface ISO 1302	tolerance ISO 406 ISO 1101	projection 	product family BERGSTIK
ltr	ecn no	dr	date	tolerances unless otherwise specified	title
S				linear XXX±.01/XX±0.3 XXX±.005/XXX±0.13 XXX±.0020/XXX±0.05	.100 UNSHROUDED HDR. S/R VERT. SURF. MNT.
				0°±2'	scale 1:1
		dr	D.INGRAM	05/11/99	
		enr	H.SUNDY	07/21/99	
		chr	H.SUNDY	07/21/99	
		appd	H.SUNDY	07/21/99	
sheet index	revision sheet				dwg no 54201 sheet 3 of 3 size A3 type Product Customer Drawing

X-ON Electronics

Largest Supplier of Electrical and Electronic Components

Click to view similar products for [Headers & Wire Housings](#) category:

Click to view products by [Amphenol](#) manufacturer:

Other Similar products are found below :

[892-18-020-10-001101](#) [58102-G61-06LF](#) [582553-1](#) [0009485154](#) [009176003701906](#) [0050291907](#) [LY20-4P-DT1-P1E-BR](#) [02.125.8002.8](#)
[609-3404](#) [61062-3](#) [622-0430](#) [622-3653LF](#) [63453-116](#) [636-1030](#) [636-1427](#) [636-3427](#) [636-4007](#) [641938-9](#) [641991-4](#) [644827-2](#) [65817-010LF](#)
[65817-015LF](#) [65863-015LF](#) [66207-023LF](#) [67095-007LF](#) [67601157](#) [68648-049](#) [70.362.1628.0](#) [70-4210](#) [70-4226B](#) [70-4853B](#) [707-5020](#) [707-](#)
[5028](#) [71.350.2428.0](#) [71918-208LF](#) [71961-016LF](#) [733-134](#) [733-162](#) [754199-000](#) [760-3052](#) [787-8014-00](#) [79531-3000](#) [FCN-360C032-B](#) [FCN-](#)
[367T-T012/H](#) [FCN-723D010/2](#) [80.063.4001.1](#) [800-90-001-10-001000](#) [800-90-010-10-002000](#) [801-43-002-10-013000](#) [801-43-006-10-002000](#)