

PRODUCT NUMBER
 5 4 2 0 2 - X X X X X - X X X LF

PLATING
 S=15μ[0.38μm]
 ON CONTACT AREA
 100μ[2.5μm]TIN
 ON TAIL(NOTE 13)
 G=30μ[0.76μm]
 ON CONTACT AREA
 100μ[2.5μm]TIN
 ON TAIL(NOTE 13)
 T=100μ[2.5μm]TIN
 ON CONTACT AREA
 AND ON TAIL(SEE NOTE 11)
 F=2μ[0.05μm]GOLD
 ON CONTACT AREA
 AND ON TAIL

LEAD STYLE	POST	TAIL OVERALL WIDTH	PCB LAYOUT
06	0.177/4.50	.290 ^{+0.015} / _{-0.017} / 7.37 ^{+0.38} / _{-0.43}	FIGURE 1
08 30	0.230/5.84 0.318/8.08	.290 ^{+0.015} / _{-0.017} / 7.37 ^{+0.38} / _{-0.43}	FIGURE 1
60	0.575/14.60	.374 ^{+0.015} / _{-0.017} / 9.50 ^{+0.38} / _{-0.43}	FIGURE 2

NOTES:

① HOUSING MAT'L: HIGH TEMPERATURE THERMOPLASTIC.
 FLAME RETARDANT PER UL 94V-0
 COLOR: BLACK
 OR
 MINERAL FILLED LCP FLAME RETARDANT
 PER UL-94V-0. COLOR: BLACK.

THESE PART NUMBERS WILL WITHSTAND EXPOSURE
 TO 260 C PEAK TEMPERATURE FOR 20 SECONDS IN
 WAVE SOLDER, INFRA-RED OR VAPOR PHASE SOLDER PROCESS.

- ② PIN MATERIAL: PHOSPHOR-BRONZE
- ③ TO DETERMINE DIMENSIONS:
 N = NUMBER OF POSITIONS ROW.
 EXAMPLE: 10 POS., N x .100/2.54=1.00/25.4
- ④ 2LBS/0.9KG MIN. PIN RETENTION IN EITHER DIRECTION.
- ⑤ PACKAGING: NONE =POLY BAGS WITHOUT PICKUP CAP.
 T =TUBES (OMIT DASH IF NOT POLARIZED).
 P =TUBES WITH PICKUP CAPS.
 A =TAPE AND REEL WITH PICKUP CAPS.
 C =CUSTOMIZED TAPE AND REEL WITH PICKUP CAPS.
 D =TAPE AND REEL WITHOUT PICKUP CAPS.
 S =SPECIAL REQUEST OF TAPE AND REEL WITH PICKUP CAPS.
 M =TAPE AND REEL WITH PICKUP CAPS FOR SPECIAL CUSTOMER.
- ⑥ FOR POLARIZATION, SPECIFY POSITION NUMBER
 (i.e. A03=ROW A POS. 3) TO OMIT PIN.
 OMIT FROM PRODUCT NUMBER IF THIS FEATURE IS NOT APPLICABLE.
 PRODUCT MANAGEMENT APPROVAL REQUIRED PRIOR TO RELEASE
 OR SALE OF POLARIZED PRODUCTS.

- 7. UNDERPLATING: 50μ"/1.2μm Ni.
- 8. PIN TIPS ON Sn PLATED PRODUCT MAY HAVE BARE METAL ON TWO SIDES,
 BOTH ENDS.
- ⑨ PART NUMBERS WITH "LF" SUFFIX AT THE END ARE LEAD FREE.
- ⑩ THESE PRODUCTS MEETS EUROPEAN UNION DIRECTIVES AND OTHER
 COUNTRY REGULATION AS DESCRIBED IN GS-22-008.
- ⑪ "THIS PRODUCT HAS 100% PURE TIN PLATING IN THE INTERFACE AND
 HAS NOT BEEN TESTED FOR WHISKER GROWTH IN ALL INTERCONNECT
 ENVIRONMENTS."
- 12. THE HOUSING WILL WITHSTAND EXPOSURE TO 260°C PEAK TEMPERATURE
 FOR 20 SECONDS IN A CONVECTION, INFRA-RED OR VAPOR PHASE REFLOW
 OVEN. SEE APPLICATION NOTES/PROCEDURES IF THEY ARE AVAILABLE.
- ⑬ MAY BE EITHER GOLD OR GXT PLATED AT MANUFACTURER'S OPTION

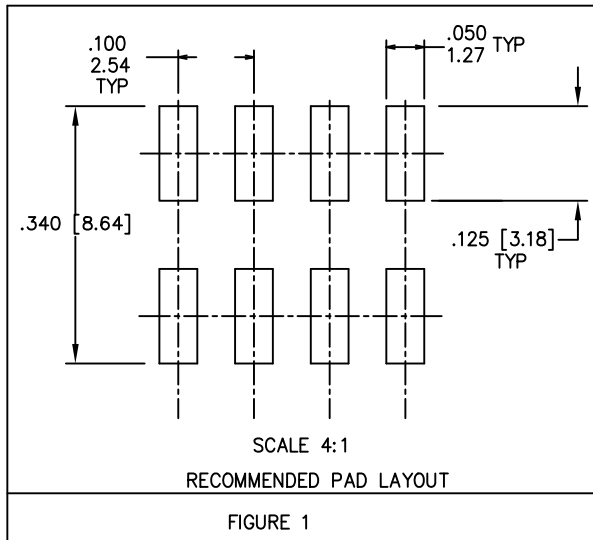

FIGURE 1

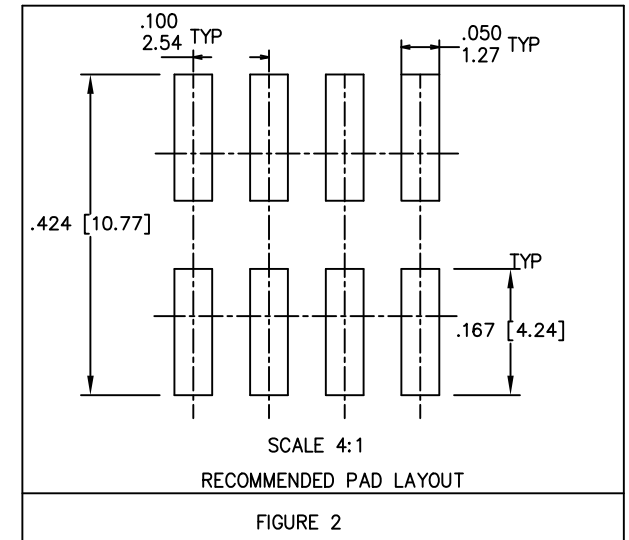
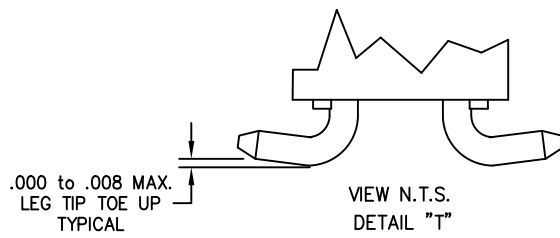
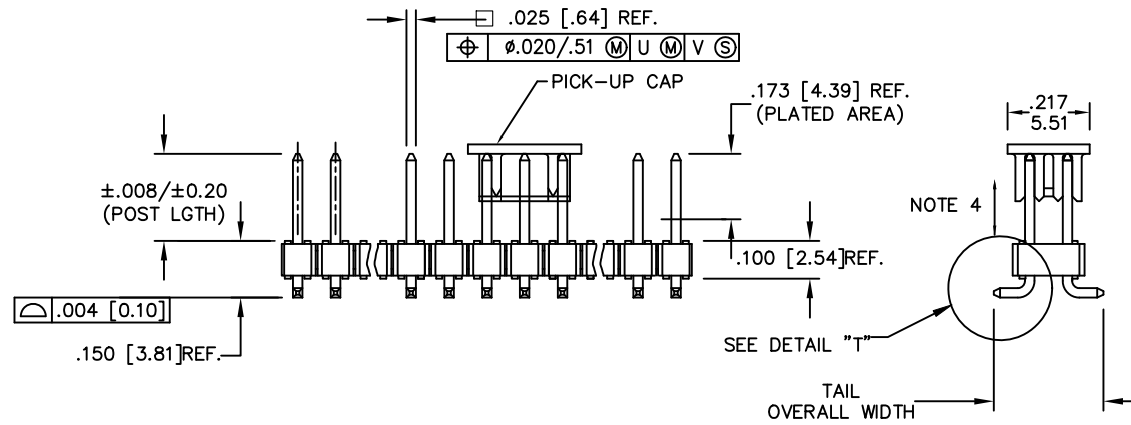
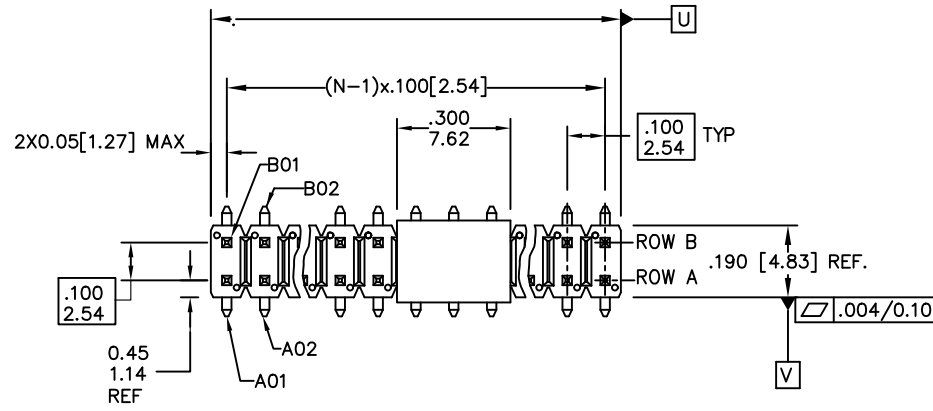

FIGURE 2

mat'l. code NOTES 2 & 3		surface ISO 1302 ✓		tolerance ISO 406 ISO 1101		projection 		product family BERGSTIK	
ltr	ecn no	dr	date	tolerances unless otherwise specified		title		.100 UNSHROUDED HDR DUAL ROW VERT. SMT.	
AA	ELX-N-21232	MZ	2015-06-25	angles	.XX±01/.X±0.3	INCH/MM		dwg no	
AB	ELX-N-22858	MZ	2015-12-22	linear	.XXX±005/.XX±0.13	scale 1:1		sheet 1 of 3	
AC	ELX-N-35783	MZ	2020-01-03	0±.2'	.XXXX±0020/.XXX±0.051	Amphenol FCI		size A3	
sheet		revision		AC	AC	AC	AC	type Product Customer Drawing	
index		sheet		1	2	3	4		

PRODUCT NUMBER
SEE SHEET 1



mat'l. code NOTES 2 & 3		surface ISO 1302 ✓	tolerance ISO 406 ISO 1101	projection INCH/MM	product family BERGSTIK
ltr	ecn no	dr	date	tolerances unless otherwise specified	title .100 UNSHROUDED HDR DUAL ROW VERT. SMT.
AC				angles linear 0±2'	scale 1:1
				dr D.INGRAM 1999-05-17	Amphenol FCI
				enr H.SUNDAY 1999-07-21	dwg no 54202
				chr H.SUNDAY 1999-07-21	sheet 2 of 4
				appd H.SUNDAY 1999-07-21	size A3
sheet index		revision sheet			type Product Customer Drawing

TAPE AND REEL PACKAGING

SIZE	LEAD STYLE 08 POST (0.230 [5.84])	LEAD STYLE 30 POST (0.318 [8.08])
2X2	YES	YES
2X3	YES	
2X4	YES	YES
2X5	YES	
2X6	YES	
2X7	YES	YES
2X8	YES	
2X9	YES	
2X10	YES	
2X11	YES	
2X12	YES	YES
2X13	YES	
2X14	YES	
2X15	YES	
2X16	YES	YES
2X17	YES	
2X18	YES	
2X19	YES	
2X20	YES	

Cross Reference

CORE RANGE	EXTENDED RANGE
54202-X08XXLF	95278-X01-XXLF
54202-X30XXLF	95278-X02-XXLF

TAPE AND REEL PACKAGING

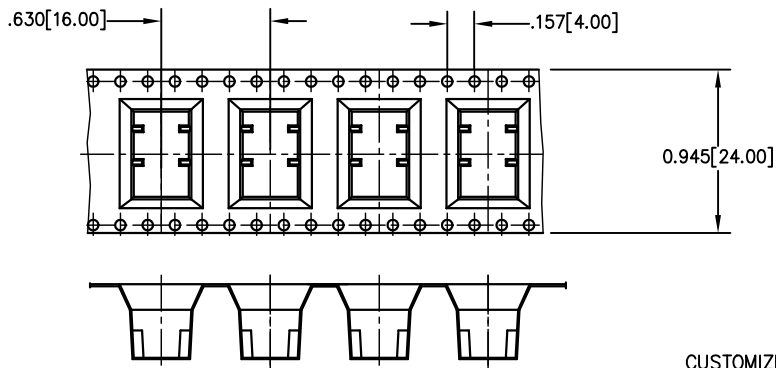
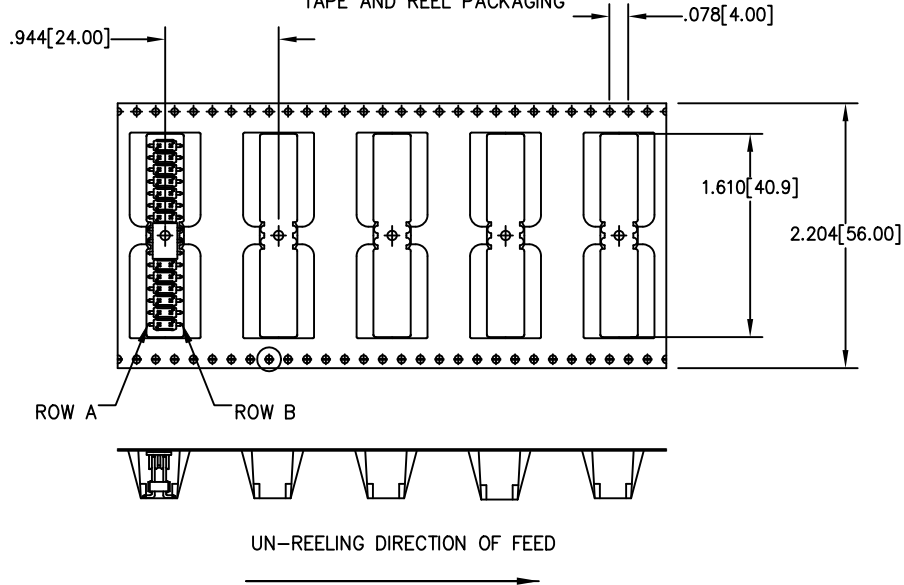

CUSTOMIZED CARRIER TAPE FOR 2x2,2x3,2x4,2x5 SIZE. (SEE NOTE 5)

Amphenol FCI

© 2016 AFCI

mat'l. code NOTES 2 & 3		surface ISO 1302	tolerance ISO 400 ISO 1101	projection 	product family BERGSTIK
ltr	ecn no	dr	date	tolerances unless otherwise specified	title .100 UNSHROUDED HDR DUAL ROW VERT. SMT.
AC				angles linear .XX±01/.X±0.3 .XXX±005/.XX±0.13 .XXXX±0020/.XXX±0.051	dwg no 54202
				0±2'	sheet 3 of 4 A3
		dr	D.INGRAM	1999-05-17	size
		enr	H.SUNDAY	1999-07-21	type Product Customer Drawing
		chr	H.SUNDAY	1999-07-21	
		appd	H.SUNDAY	1999-07-21	
sheet index	revision sheet				

A
 B
 C
 D

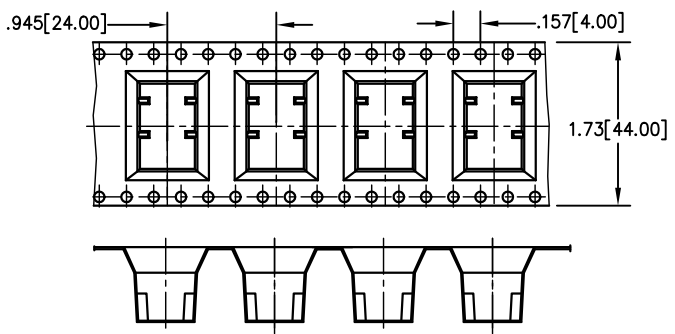

UN-REELING DIRECTION OF FEED

54202-****SLF
 SPECIAL REQUEST CARRIER TAPE
 FOR 2x5 SIZE(SEE NOTES 5)

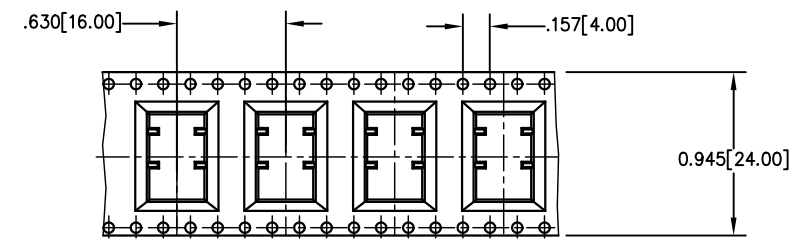

UN-REELING DIRECTION OF FEED

54202-****MLF
 TAPE AND REEL WITH PICK UP
 CAP FOR SPECIAL CUSTOMER
 FOR 2x5 SIZE(SEE NOTES 5)

© 2016 APCI
 Amphenol
 FCI

mat'l. code NOTES 2 & 3		surface ISO 1302	tolerance ISO 406 ISO 1101	projection 	product family BERGSTIK
ltr	ecn no	dr	date	tolerances unless otherwise specified	title .100 UNSHROUDED HDR DUAL ROW VERT. SMT.
AC				angles linear .XX±01/.X±0.3 .XXX±005/.XX±0.13 .XXXX±0020/.XXX±0.051	INCH/MM scale 1:1
		dr	D.INGRAM	1999-05-17	dwg no 54202
		enr	H.SUNDAY	1999-07-21	sheet 4 of 4 A3
		chr	H.SUNDAY	1999-07-21	type Product Customer Drawing
		appd	H.SUNDAY	1999-07-21	
sheet index	revision sheet				

X-ON Electronics

Largest Supplier of Electrical and Electronic Components

Click to view similar products for [Headers & Wire Housings](#) category:

Click to view products by [Amphenol](#) manufacturer:

Other Similar products are found below :

[892-18-020-10-001101](#) [58102-G61-06LF](#) [582553-1](#) [0009485154](#) [009176003701906](#) [0050291907](#) [LY20-4P-DT1-P1E-BR](#) [02.125.8002.8](#)
[609-3404](#) [61062-3](#) [622-0430](#) [622-3653LF](#) [63453-116](#) [636-1030](#) [636-1427](#) [636-3427](#) [636-4007](#) [641938-9](#) [641991-4](#) [644827-2](#) [65817-010LF](#)
[65817-015LF](#) [65863-015LF](#) [66207-023LF](#) [67095-007LF](#) [67601157](#) [68648-049](#) [70.362.1628.0](#) [70-4210](#) [70-4226B](#) [70-4853B](#) [707-5020](#) [707-](#)
[5028](#) [71.350.2428.0](#) [71918-208LF](#) [71961-016LF](#) [733-134](#) [733-162](#) [754199-000](#) [760-3052](#) [787-8014-00](#) [79531-3000](#) [FCN-360C032-B](#) [FCN-](#)
[367T-T012/H](#) [FCN-723D010/2](#) [80.063.4001.1](#) [800-90-001-10-001000](#) [800-90-010-10-002000](#) [801-43-002-10-013000](#) [801-43-006-10-002000](#)