

NUMBER BUS-12-064	TYPE PRODUCT SPECIFICATION		
TITLE BergPin®		PAGE 1 of 13	REVISION F
		AUTHORIZED BY H. T. BREWBAKER	DATE 04 SEP 08
CLASSIFICATION UNRESTRICTED			

1.0 OBJECTIVE

This specification defines the performance, test, quality and reliability requirements of the BergPin® 0.64mm/0.025 inch square pin product.

2.0 SCOPE

This specification covers the BergPin® 0.64mm/0.025 inch square pin for use in single or double-sided printed wiring boards.

3.0 GENERAL

3.1 Index This document is composed of the following sections:

<u>Paragraph</u>	<u>Title</u>	<u>Page</u>
1.0	OBJECTIVE	1
2.0	SCOPE	1
3.0	GENERAL	1
3.1	Index	1
3.2	Type	1
3.3	Classification	2
3.4	Banned/Restricted Substances	2
4.0	APPLICABLE DOCUMENTS	2
5.0	REQUIREMENTS	3
5.1	Qualification	3
5.2	Material	3
5.3	Finish	3
5.4	Design and Construction	3
5.5	Electrical Characteristics	4
5.6	Mechanical Characteristics	5
5.7	Environmental Characteristics	6
6.0	QUALITY ASSURANCE PROVISION	8
7.0	PACKAGING AND MARKING	11
8.0	GENERAL INFORMATION	12

3.2 Type The BergPin® shall be available in one of the following types, as limited by the appropriate product drawing.

<u>Type</u>	<u>Plating</u>
I.	0,76u/30u" gold
II.	1,27u/50u" gold
III.	0,38u/15u" gold
IV.	3,05u/120u" tin-lead
V.	0,76u/30u" GXT
VI.	0,38u/15u" GXT
VII.	2,54u/100u" tin

NUMBER BUS-12-064	TYPE PRODUCT SPECIFICATION		
TITLE BergPin®		PAGE 2 of 13	REVISION F
		AUTHORIZED BY H. T. BREWBAKER	DATE 04 SEP 08
CLASSIFICATION UNRESTRICTED			

3.3 Classification. BergPin® shall be classified as follows:

Class I: Reeled BergPin® suitable for automatic or semiautomatic application.

Class II Loose-piece BergPin® suitable for handtool application.

Unless otherwise specified herein all requirements are applicable to both classes of BergPin®

3.4 Banned/Restricted Substances All product where the part number ends in "LF" meet the European Union directives and other country regulations as described in GS-22-008. The part numbers that do not end in "LF" meet all regulations except for Pb in SnPb plating, if available. Tin plated "LF" product has 100% tin plating in the interface and has not been tested for whisker growth in all interconnect environments.

4.0 APPLICABLE DOCUMENTS

4.1 Issues of Documents . The following documents, of the issue in effect on the date of the latest revision of this specification, shall form a part of this specification to the extent specified herein.

SPECIFICATIONS

FEDERAL

QQ-N-290 Nickel Plating (Electrodeposited)
 QQ-W-343 Wire Electrical and Nonelectrical, copper, (Uninsulated)
 QQ-B-613 Brass, Leaded and Nonleaded
 QQ-B-750 Bronze, Phosphor: Bar, Plate. Rod, Sheet, Strip, Flat Wire, and Structural and Special-Shaped Sections.

MILITARY

MIL-F-14256 Flux,Soldering. Liquid (Rosin Base), Activated.
 MIL-P-13949 Plastic sheet, Laminated, Metal-Clad (for printed wiring) General Specification for
 MIL-G-45204 Gold Plating, Electrodeposited
 MIL-P-55110 Printed Wiring Boards
 MIL-P-81728 Plating, Tin-Lead (Electrodeposited)
 MIL-P-45209 PALLADIUM Plating, (Electrodeposited)

MIL-STD-105 Sampling Procedures and Tables for Inspection by Attributes
 MIL-STD-202 Test Methods for Electrical and Electronic
 MIL-STD-275 Printed Wiring for Electronic Equipment
 MIL-STD-1130 Connections, Electrical Solderless Wrapped
 MIL-STD-1344 Test Methods for Electrical Connectors
 MIL-STD-45662 Calibration Systems Requirements

4.2 Other Publications The following documents from a part of this specification to the extent specified herein:

American Society for Testing and Materials (ASTM) ASTM B-159-Phosphor Bronze Wire

NUMBER BUS-12-064	TYPE PRODUCT SPECIFICATION		
TITLE BergPin®		PAGE 3 of 13	REVISION F
		AUTHORIZED BY H. T. BREWBAKER	DATE 04 SEP 08
CLASSIFICATION UNRESTRICTED			

5.0 REQUIREMENTS

- 5.1 Qualification - Panel assemblies produced using BergPin® furnished under this specification shall be capable of meeting the qualification test requirements specified here. (see 6.0)
- 5.2 Material - The material for each part shall be as specified herein, or equivalent. Substitute material shall meet the performance requirements of this specification.
- 5.2.1 BergPin® The pin shall be drawn wire phosphor bronze alloy UNS C-51000, in accordance with ASTM B-159.
- 5.2.2 Carrier The separable carrier (reeled version only) shall be brass alloy UNS C-26000, in accordance with QQ-B-613.
- 5.3 Finish
- 5.3.2 BergPin® The finish on the pin shall be as specified herein for the particular type (see Paragraph 3.2) of BergPin® under consideration.
- 5.3.1.1 Types I, II and III. The pin shall be gold plated with the specified minimum thickness (see Paragraph 3.2). The plated deposits shall be in accordance with MIL-G-45204, Type II, Grade Cover 1,27u/50u" minimum of nickel. The plated deposits shall be in accordance with QQ-N-290, class 2. Non-critical areas such as the sheared tips may have exposed base metal.
- 5.3.1.2 Type IV The pin shall be plated with 3,05u/120u" minimum of 93/7 tin-lead. Over 1,27u/50u" minimum of nickel. The plated deposits shall be in accordance with MIL-P-81728. Non-critical areas such as the sheared tips may have exposed base metal.
- 5.3.1.3 Type V and VI The pin shall be plated with 0,76/30u" or 0,38u/15u" minimum respectively of palladium alloy. The plated deposits shall be in accordance MIL-P-45209 and a thin soft gold flash over 1,27u/50u" minimum of nickel. The plated deposits shall be in accordance with QQ-N-290, Class 2. Non-critical areas such as the sheared tip may have exposed base metal.
- 5.3.1.4 Type VII The pin shall be plated with 2,54/100u" of tin over 1,27/50u" minimum of nickel. The plated deposits shall be in accordance with GS-46-001 (Confidential). Non-critical areas such as the sheared tip may have exposed base metal.
- 5.4 Design and Construction The BergPin® shall be available in various above and below board lengths suitable for use as 0,64mm/0.025 inch square male disconnects or as similarly configured wrapposts for solderless wrapped connections, in accordance with MIL-STD-1130. The pin shall incorporate a formed staking area, known as a star, providing mechanical stability of the free-standing pin. The standard BergPin® shall have 0,99 +0,03 – 0,05mm/0.039 + .001,-.002 inch, star diagonal and a large star BergPin® shall have a 1,04 ± 0,03mm/0.041 ± .001 inch. star diagonal.

Pin Lengths - The standard pin is available in a variety of installed lengths.

NUMBER BUS-12-064	TYPE PRODUCT SPECIFICATION		
TITLE BergPin®		PAGE 4 of 13	REVISION F
		AUTHORIZED BY H. T. BREWBAKER	DATE 04 SEP 08
CLASSIFICATION UNRESTRICTED			

5.4.1 Installation The standard BergPin® with 0.99mm / 0.039 inch diagonal star shall be installed in a plated-through hole having a finished diameter of $0,81 \pm 0,05\text{mm} / 0.032 \pm .002$ inch for 1,57mm / 0.062 inch thick PWB (Printed Wiring Board) and $0,86 \pm 0.05\text{mm} / 0.034 \pm .002$ inch for 3.18mm / 0.125 inch thick PWB. The large star BergPin® with 1.04mm / .041 inch diagonal star shall be installed in a plated-through-hole having a finished diameter of $0,86 \pm 0,05\text{mm} / 0.034 \pm .002$ inch for 1.57mm / 0.062 inch PWB, and $0.91 \pm 0.05\text{mm} / 0.036 \pm .002$ inch for 2.36mm / 0.093 inch and 3.18mm / 0.125 inch PWB. The Pin shall be capable of installation on minimum centers of 2.54mm / 0.100 inch on PWB. The BergPin® shall be soldered in accordance with good industry techniques that insure a sound solder bond in order to meet the specifications called herein. The breakout of termination holes should be no greater than .127mm / 0.005 inch x 45 ° or .127mm / 0.005 inch radius.

5.4.2 Printed Wiring Board requirements The laminate used in the fabrication of printed wiring boards shall be typed GE* **** A1/1A A1/B, in accordance with MIL-P-13949, or equivalent. Plated-through-holes shall be constructed as follows:

Drilled Hole Diameter – $1,02 \pm 0,03\text{mm} / 0.040 \pm .001$ inch for Large Star BergPin®

$0,97 \pm 0,03\text{mm} / 0.038 \pm .001$ inch for Standard Star BergPin®

Copper Plated Thickness – 0,03mm / 0.001 inches (minimum)

Tin-Lead (60-40) Plating Thickness – 0,00762mm / 0.0003 inches (minimum):
0,0178mm / 0.0007 inches (maximum)

*N or P is optional

**** 0930 or 1250, as appropriate

5.4.3 Wrappost The wrappost geometry shall be in accordance with Para. 5.2 of MIL-STD-1130. The tip of the wrappost shall be bevelled to facilitate insertion into the bit of the wire wrap tooling.

5.4.4 Workmanship Pin shall be uniform in quality and shall be free from burrs scratches, cracks, voids, chips, sharp edges, and other defects that will adversely affect life or serviceability.

5.5 Electrical Characteristics

5.5.1 Operating Temperature Unless otherwise specified, the pins shall have an operating temperature of + 85 ° C maximum and – 40 ° C minimum.

5.5.2 Low-Level Circuit Resistance The low-level circuit resistance between the pin and the plated-through-hole after soldering shall not exceed 0.2 milliohms when measured in accordance with MIL-STD-1344, Method 3002. The following details shall apply:

A. Test Current-100ma, maximum (short circuit)

B. Open Circuit Voltage-20 mv D.C., maximum

C. Method of Connection-attach current and voltage leads as shown in Figure 1.

NUMBER BUS-12-064	TYPE PRODUCT SPECIFICATION	FCI	
TITLE BergPin®		PAGE 5 of 13	REVISION F
		AUTHORIZED BY H. T. BREWBAKER	DATE 04 SEP 08
CLASSIFICATION UNRESTRICTED			

5.5.3 Current rating The Pin provides the electrical resistance equivalent of AWG 29 wire in a balanced system would be rated at approximately 3.0 Amperes D.C.

FIGURE 1- LOW-LEVEL CIRCUIT RESISTANCE

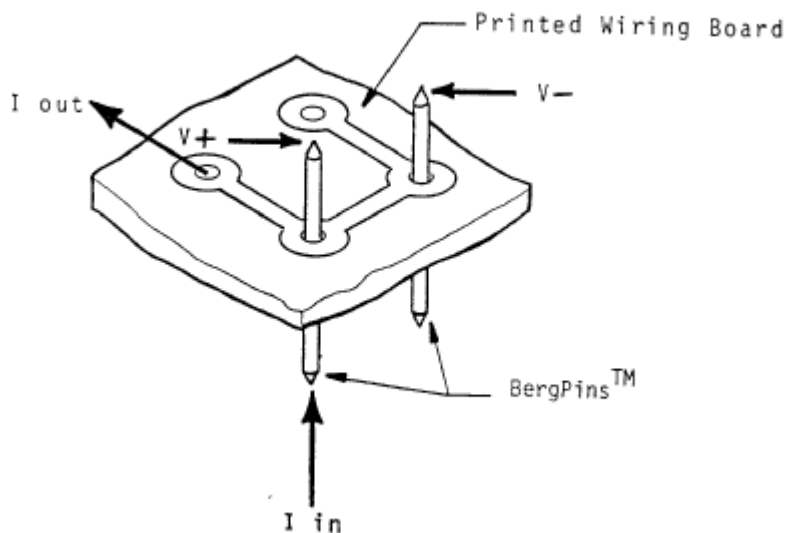

5.6 Mechanical Characteristics

- 5.6.1 Contact retention Depending upon Pin to plated-through-hole interference the pin could have 8.9 to 89N (2 to 20 lbs) of retention force before the assembled boards are soldered.
- 5.6.2 Wrappost Torque A torque of 0.021 N.m (3.0 ounce-inches) applied to the tip of the installed wrappost shall not cause yielding of this member, when tested in accordance with MIL-STD-202, Method 211, condition E.

NUMBER BUS-12-064	TYPE PRODUCT SPECIFICATION	FCI	
TITLE BergPin®		PAGE 6 of 13	REVISION F
		AUTHORIZED BY H. T. BREWBAKER	DATE 04 SEP 08
CLASSIFICATION UNRESTRICTED			

5.6.3 in Tail Straightening After tail straightening of either end, the pin shall exhibit no change in position of the end and shall meet all electrical and mechanical requirements of this specification. The following details shall apply:

- A. Deflection-0,89mm/0.035 inch (in any direction)
- B. Plane of Bending-parallel to sides of wrappost
- C. Pattern-see Figure 2
- D. Tooling Bar Location-3,81mm/0.150 inch from board

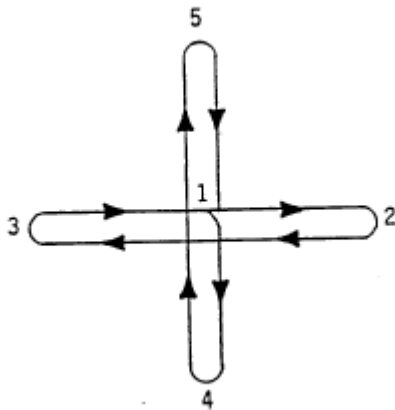

Sequence: 1-2-1-3-1-4-1-5-1

FIGURE 2- TAIL STRAIGHTENING PATTERN

5.7 Environmental Conditions

5.7.1 Thermal Shock After exposure of the assembly to alternate periods of extreme high and low temperatures, the contact retention shall be not less than 44,40N (10lbs.) (see Paragraph 5.4.1 The test shall be in accordance with MIL-STD-1344, Method 1003, condition A; the following details shall apply:

- A. Temperature Range- +85 ° C to -55 ° C
- B. Time at Temperature-30 minutes each per cycle
- C. Transfer Time- 5 minutes, maximum
- D. Number of cycles-5

NUMBER BUS-12-064	TYPE PRODUCT SPECIFICATION		
TITLE BergPin®		PAGE 7 of 13	REVISION F
		AUTHORIZED BY H. T. BREWBAKER	DATE 04 SEP 08
CLASSIFICATION UNRESTRICTED			

5.7.2 High-Temperature Life After exposure of the nonoperating assembly to a high-temperature environment, the low-level circuit resistance shall not exceed 0.2 milliohms (see Paragraph 5.5.2) and the contact retention shall not be less than 44,40N(10lbs.) (see Paragraph 5.4.1). The test shall be in accordance with MIL-STD-1344, Method 1005, Test Condition 3, Time Condition D; the following details shall apply:

- A. Exposure Temperature-+85 ° C
- B. Exposure Time- 1000 hours

5.7.3 Shock There shall be no evidence of damage when the assembly is subjected to transient accelerations. The test shall be in accordance with MIL-STD-1344, Method 2004.1, Condition A; the following details shall apply.

- A. Shock Pulse- 50g peak, 11 millisecond, half-sine
- B. Number of shocks- 3 shocks in each direction along three orthogonal axes (18 total)
- C. Mounting-see Figure 3
- D. Pin shall be soldered on P. C. Board

5.7.4 Vibration There shall be no evidence of damage when the assembly is subjected to prolonged mechanical vibration; after the test, the contact retention shall not be less than 44,40N (10lbs.) (see Paragraph 5.4.1). The test shall be in accordance with MIL-STD-344, Method 2005, Condition III; the following details shall apply:

- A. Vibration amplitude- 1,52mm/0.06 inch DA or $\pm 15g$
- B. Frequency Range- 10 to 2000 Hz
- C. Test Duration – 4 hours along each of three orthogonal axes (12 hours total)
- D. Mounting – see Figure 3

NUMBER BUS-12-064	TYPE PRODUCT SPECIFICATION		
TITLE BergPin®		PAGE 8 of 13	REVISION F
		AUTHORIZED BY H. T. BREWBAKER	DATE 04 SEP 08
CLASSIFICATION UNRESTRICTED			

BergPin®

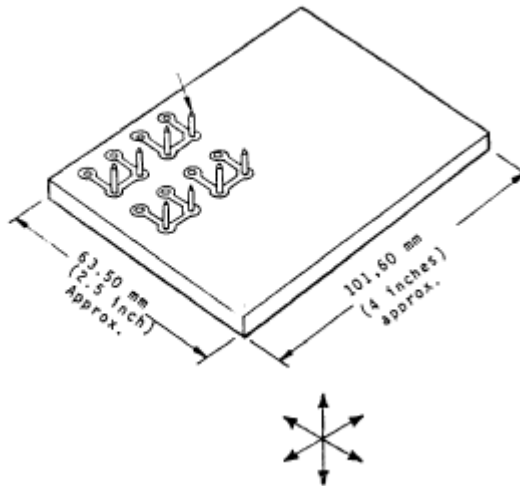

NOTE: Printed Wiring Board to be rigidly mounted along four edges.

Axes
FIGURE 3- MOUNTING FOR SHOCK AND VIBRATION

6.0 QUALITY ASSURANCE PROVISION

- 6.1 Responsibility of Inspection FCI will use its own or approved facilities suitable for the performance of the specified herein, unless negotiated by the procuring activity.
- 6.2 Equipment Calibration All test equipment and inspection facilities used in the performance of any test shall be maintained in a calibration system in accordance with MIL-STD-45662.
- 6.3 Inspection Conditions Unless otherwise specified herein, all inspections shall be performed under the following ambient conditions:

Temperature: 25 °C ± 5 °C

Relative Humidity: 30 to 80 %

Barometric Pressure: local ambient

- 6.4 Qualification Inspection Qualification inspection shall be performed on sample units produced with equipment and procedures normally used in production.

NUMBER BUS-12-064	TYPE PRODUCT SPECIFICATION		
TITLE BergPin®		PAGE 9 of 13	REVISION F
		AUTHORIZED BY H. T. BREWBAKER	DATE 04 SEP 08
		CLASSIFICATION UNRESTRICTED	

6.4.1 Sample Six hundred forty (640) standard BergPin® of length suitable for tail straightening (see Paragraph 5.6.3), shall be subjected to the qualification inspection.

6.4.2 Preparation of Sample Boards

6.4.2.1 Printed Wiring Boards Four (4) test boards conforming to the applicable requirement of MIL-P-55110 and MIL-STD-275. Shall be prepared as shown in Figure 4. Board thickness and finished hole size combinations, for the indicated sample board number, shall be in accordance with Table 1.

Table 1 – Board configuration

<u>Board Thickness</u>		<u>Finished Hole Diameter</u>	
		<u>Max.</u>	<u>Min.</u>
1,57mm/ .062 inches	Board	1,3	4
2,36mm/ .093 inches		-	2

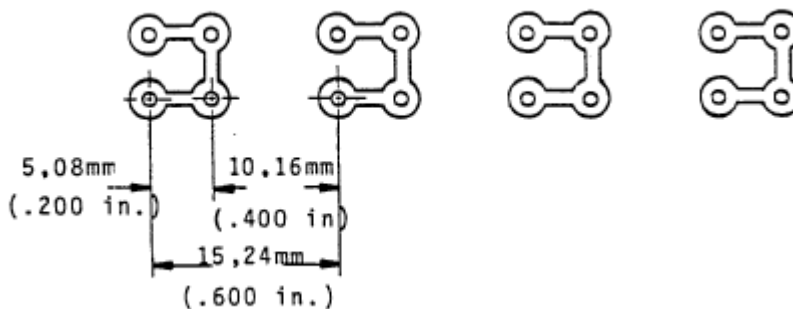

FIGURE 4 – PRINTED WIRING BOARD (TEST)

NUMBER BUS-12-064	TYPE PRODUCT SPECIFICATION	FCI	
TITLE BergPin®		PAGE 10 of 13	REVISION F
		AUTHORIZED BY H. T. BREWBAKER	DATE 04 SEP 08
		CLASSIFICATION UNRESTRICTED	

6.4.2.2. Sample Installation Pins shall be installed and soldered in each printed wiring test board in two (2) rows of forty (40) each, as shown in Figure 5. One (1) row of pins shall be tail-straightened (see Paragraph 5.6.3).

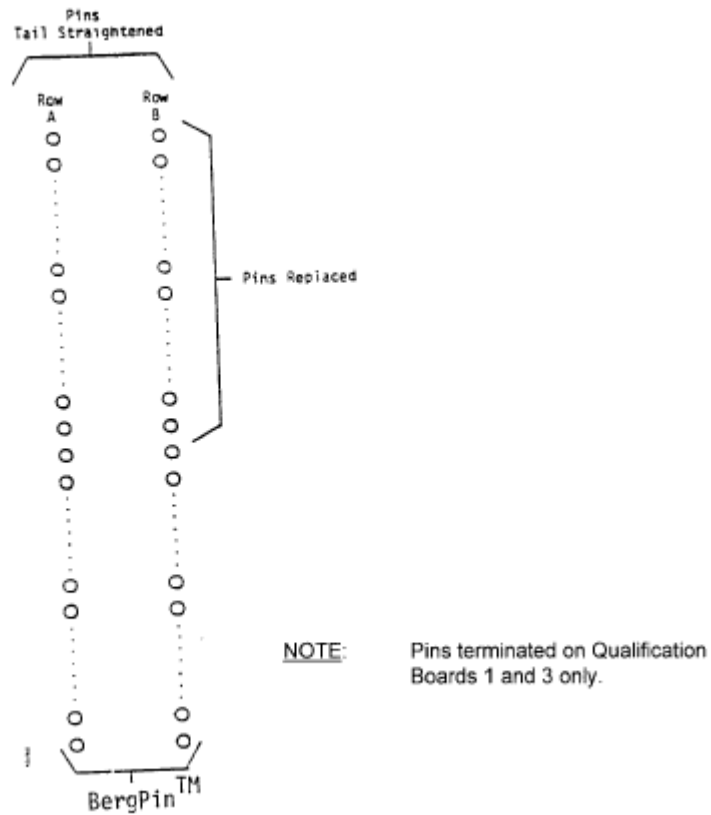



FIGURE 5 – TEST SAMPLE CONFIGURATION

NUMBER BUS-12-064	TYPE PRODUCT SPECIFICATION		
TITLE BergPin®		PAGE 11 of 13	REVISION F
		AUTHORIZED BY H. T. BREWBAKER	DATE 04 SEP 08
CLASSIFICATION UNRESTRICTED			

6.4.3 Test Sequence The assemblies shall be subjected to the inspections specified in Table II, in the order shown.

TABLE II – QUALIFICATION INSPECTION

Examination or Test	Paragraph	<u>Sample Board Number</u>			
		1	2	3	4
Thermal Shock / <u>1</u>	5.7.1	X	X	-	=
High Temperature Life / <u>1</u>	5.7.2	X	X	-	-
Shock	5.7.3	-	-	X	X
Vibration / <u>1</u>	5.7.4	-	-	X	X
Wrappost Torque	5.6.2	/ <u>3</u>	/ <u>3</u>	/ <u>3</u>	/ <u>3</u>

/2 Pins 1 to 10 and 31 to 40 in each row only.

/3 Pins in 1 to 10 in each row.

6.5 Inspection Lot and Stamping Plan.

- 6.5.1 Inspection Lot An inspection lot shall consist of all pins produced under essentially the same conditions and offered for inspection at one time.
- 6.5.2 Sampling Plan Statistical sampling and inspection shall be in accordance with MIL-STD-105, General Inspection Level II.
- 6.5.3 Rejection Lots Rejected lots shall be screened to remove defective units and resubmitted for inspections.

7.0 PACKAGING AND MARKING

7.1 Unless the pins are specifically requested in the form of loose piece, they shall be held by a continuous brass bandolier for the convenience of packaging and automatic application on the printed circuit board. The loose piece pins shall be packaged in a polyethylene bag in quantity of 1000 with a label 336129-XXX giving product number, quantity, date, code, operator and QC. The bandoliered pins shall be reeled in quantity of 12,500 at 5.08mm / 0.200 inch lead or 25,000 at 2.54mm / .100 inch lead on a 48.3cm / 19 inch diameter corrugated pancake reel with 14cm / 5.5 inch diameter hub and laced with interleaving paper. The reel shall have a label 336129-XXX giving FCI product number, quantity, date, code, QC, and operator information.

NUMBER BUS-12-064	TYPE PRODUCT SPECIFICATION		
TITLE BergPin®		PAGE 12 of 13	REVISION F
		AUTHORIZED BY H. T. BREWBAKER	DATE 04 SEP 08
CLASSIFICATION UNRESTRICTED			

7.2 Acceptance Inspection Appropriate in-process inspection may, at the option of FCI, be substituted for the indicated set sampling/inspection provided that the process output quality level is maintained.

8.0 GENERAL INFORMATION

8.1 Ordering Data Procedure documents should specify:

- A. Title, number and date of this specification.
- B. Title, number and date of the applicable product part number, the type number, the complete part number (see Table I and II).
- C. State whether the BergPin® are to be bandoliered or loose piece per Paragraph 7.0.

8.2 Mechanical stability under side-loading such as encountered during tail-straightening may not conform to the requirements of this specification.

9.0 REFERENCE DOCUMENTS N/A

10.0 NOTES N/A

11.0 RECORD RETENTION N/A

NUMBER BUS-12-064	TYPE PRODUCT SPECIFICATION		
TITLE BergPin®		PAGE 13 of 13	REVISION F
		AUTHORIZED BY H. T. BREWBAKER	DATE 04 SEP 08
CLASSIFICATION UNRESTRICTED			

REVISION RECORD

<u>REV.</u>	<u>PAGE</u>	<u>DESCRIPTION</u>	<u>EC#</u>	<u>DATE</u>
A	12	Para. 5.0 "Packaging & Marking" –change Qty. of loose pcs. Pins from 500 to 1000	13917	02/09/87
B	ALL	Change 1.1,1.2,3.3.1.2,3.3.1.3,3.4,&5.1 per mark-ups	V71813	01/05/98
C	ALL	Revised format to be consistent with GS-01-001, and change BERG, Dupont, etc. references to FCI.	V01904	07/31/00
D	1, 2, 3	Update section 1.2, add sections 1.4 and 3.3.1.4 for LF information	V05-1111	12/13/05
E	All	Change Logo	V06-0526	05/31/06
F	All	General update, reformat spec., correct typing errors, clarify P.C. board hole requirements.	V08-0352	09/04/08

X-ON Electronics

Largest Supplier of Electrical and Electronic Components

Click to view similar products for [Terminals](#) category:

Click to view products by [Amphenol](#) manufacturer:

Other Similar products are found below :

[00-054007-01074-6](#) [00-054007-70206-1](#) [00-054007-70210-8](#) [00-054007-70217-7](#) [00-054007-70226-9](#) [00-054007-70228-3](#) [00-054007-70248-1](#) [00-054007-70256-6](#) [00-054007-70301-3](#) [00-054007-70316-7](#) [00-054007-49560-4](#) [00-054007-70209-2](#) [00-054007-70225-2](#) [00-054007-70227-6](#) [00-054007-70231-3](#) [00-054007-70241-2](#) [00-054007-70242-9](#) [00-054007-70244-3](#) [00-054007-70246-7](#) [00-054007-70263-4](#) [00-054007-70288-7](#) [00-054007-70290-0](#) [00-054007-70300-6](#) [00-054007-70304-4](#) [01-2065-1-0216](#) [01-2900-1-04412](#) [00581P0075](#) [600TS-10](#) [60205-1](#) [604200-1](#) [605601-1](#) [60598-1-CUT-TAPE](#) [61314-6-C](#) [61810-3](#) [61-S](#) [62149-1](#) [626-0194](#) [62-NBM-A](#) [62-SN](#) [62-SP](#) [640179-1](#) [M55155/059I03](#) [M55155/079C01](#) [M55155/099H02](#) [M55155/109H01](#) [M55155/109H02](#) [M55155/12XH05](#) [M55155/16XH02](#) [M55155/29-5S](#) [M55155/29XJ08](#)