

Tous droits strictement reserves. Reproduction ou communication a des tiers interdite sous quelque forme que ce soit sans autorisation ecrite du proprietaire. Propriete de c FCI. Droits de reproduction FCI.

All rights strictly reserved. Reproduction or issue to third parties in any form whatever is not permitted without written authority from the proprietor. Property of FCI. Copyright FCI.

PRODUCT NUMBER

XXXXX-YYY HPLF

- LEAD FREE OPTION
SEE NOTE 1,13
- SPECIAL OPTIONS
SEE NOTE 1 OR 10
- HIGH TEMPERATURE PLASTIC
SEE NOTE 1
- NO OF POSITIONS
SEE NOTE 1
- PIN PLATING
SEE SHEET 2
- BASE PART NO.

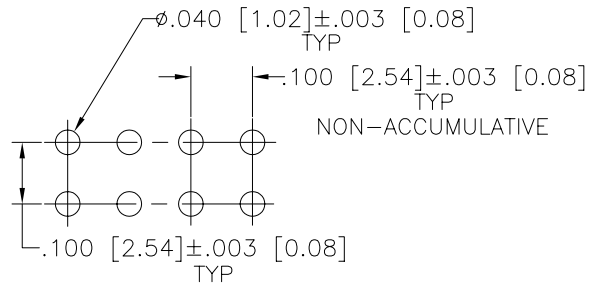
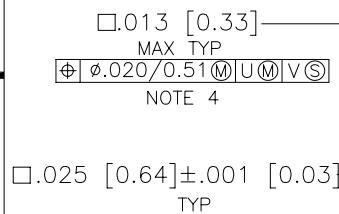
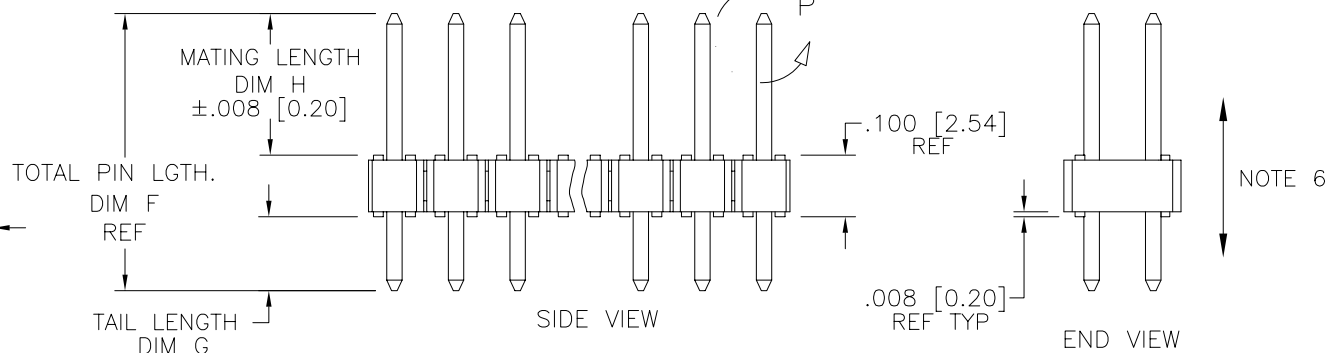
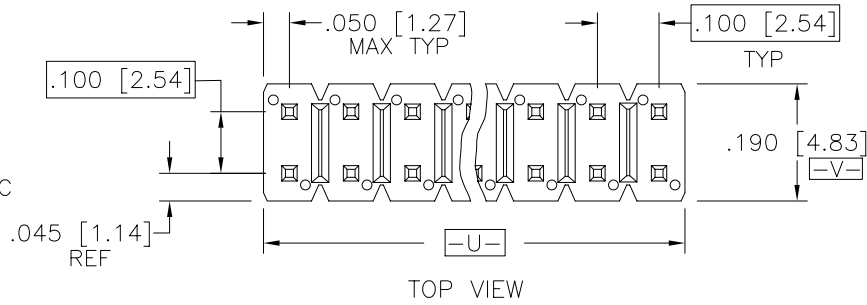

DETAIL P
SCALE 5:1
TYP BOTH ENDS

RECOMMENDED HOLE PATTERN

mat'l. code NOTE 2 & 3				tolerances unless otherwise specified				CUSTOMER COPY		 www.fciconnect.com	
ltr	ecn no	dr	date	.xx±.01/.x±.3		projection		title			
CN	V10177	MDF	01/26/01	linear .xxx±.005/.xx±.13		 INCH/MM		BERGSTIK® II HDR. D/R			
CP	V20801	GIP	04/29/02	.xxxx±.0020/.xxx±.051				.100/2.54cc STRAIGHT			
CR	V21675	GIP	10/22/02	angles σ±2°		scale		product family BERGSTIK			
CS	V21800	TAB	12/19/02	dr	T.BREWBAKER	12/21/94	A		code 213		
CT	V03-0257	DAI	03/05/03	enr	T.HANNA	12/21/94	1:1		sheet 1 of 8		
CU	M04-0234	MHT	12/29/04	chr	T.HANNA	12/21/94			size dwg no 67996		
CV	M05-0072	MHT	5/03/05	appd	T.HANNA	12/21/94			cage code 22526		
sheet index	revision sheet	CV 1	CV 2	CV 3	CV 4	CV 5	CV 6	CV 7	CV 8		

Tous droits strictement reserves. Reproduction ou communication a des tiers interdite sous quelque forme que ce soit sans autorisation ecrite du proprietaire. Propriete de c FCI. Droits de reproduction FCI.

All rights strictly reserved. Reproduction or issue to third parties in any form whatever is not permitted without written authority from the proprietor. Property of FCI. Copyright FCI.

PIN PLATING CODES:		
XXXXX-1YY	30u"/0.76u MIN (SEE NOTE 14) OVER 50u"/1.27u MIN Ni	
XXXXX-2YY	15u"/0.38u MIN (SEE NOTE 14) OVER 50u"/1.27u MIN Ni	
XXXXX-3YY	50u"/1.27u MIN Au OVER 50u"/1.27u MIN Ni	
XXXXX-4YY	TIN LEAD OPTION	120u"/3.05u MIN 93/7 SnPb OVER 50u"/1.27u MIN Ni
	LF OPTION	100u"/2.54u MIN Sn OVER 50u"/1.27u MIN Ni (SEE NOTE 1,15)
XXXXX-5YY	15u"/0.38u MIN (SEE NOTE 14) OVER 50u"/1.27u MIN Ni	
XXXXX-6YY	30u"/0.76u MIN (SEE NOTE 14) OVER 50u"/1.27u MIN Ni	
XXXXX-7YY	30u"/0.76u MIN Au OVER 50u"/1.27u MIN Ni	
XXXXX-8YY	15u"/0.38u MIN Au OVER 50u"/1.27u MIN Ni	
XXXXX-9YY	15u"/0.38u MIN GXT OVER 50u"/1.27u MIN Ni	
XXXXX-0YY	30u"/0.76u MIN GXT OVER 50u"/1.27u MIN Ni	

NOTES

① PART NUMBER OPTIONS:

PIN PLATING CODES (SEE ABOVE)

HIGH TEMPERATURE MATERIAL:

FOR HIGH-TEMPERATURE APPLICATIONS, SPECIFY AN "H" AT THE END OF THE PART NUMBER, AND PCT WILL BE SUPPLIED.

NUMBER OF POSITIONS :

EVEN NUMBER OF POSITIONS FROM 2 (2X1) THROUGH 72 (2X36).
 -X00H INDICATES BERGSTRIIP PRODUCT. SEE PAGE 3
 FOR SPECIAL GEOMETRY OF THIS CONTINUOUS STRIP PRODUCT.
 AUTOMATED REELS WILL CONTAIN 45,000 PINS.
 SEE SPECIFIC PART NUMBERS FOR AVAILABILITY.

PACKAGING:

PACKAGED IN POLY BAGS.
 EIGHT DIGIT PART NUMBERS FOLLOWED BY A "T" ARE PACKAGED IN TUBES. SEE SPECIFIC PART NUMBERS FOR AVAILABILITY.
 EIGHT DIGIT PART NUMBERS FOLLOWED BY A "G" ARE PACKAGED IN GPAX FOR IBM ONLY. SEE SPECIFIC PART NUMBERS FOR AVAILABILITY.
 PART NUMBERS FOLLOWED BY A "C" ARE PACKAGED IN TUBES WITH A PICKUP CAP APPLIED.

LEAD FREE:

ADD "HLF" SUFFIX AT THE END OF PART NUMBER FOR LEAD FREE OPTION, NOT AVAILABLE FOR -5YY,-5YYH, -6YY & -6YYH

- ② BODY MATERIAL:
 BODY MATERIAL : MANUFACTURER'S OPTION OF NYLON OR PCT, GLASS FIBER REINFORCED, FLAME RETARDENT PER UL-94V-0. COLOR: BLACK
 BERGSTRIIP™ PRODUCED WITH HIGH TEMPERATURE LCP THERMOPLASTIC, FLAME RETARDENT PER UL-94V-0. COLOR: BLACK
 PART NUMBERS WITH "H" SUFFIX WILL WITHSTAND EXPOSURE TO 260° C PEAK TEMPERATURE FOR 20 SECONDS IN WAVE SOLDER, INFRA-RED OR VAPOR PHASE SOLDER PROCESS.
 PART NUMBERS WITHOUT "H" SUFFIX WILL WITHSTAND EXPOSURE TO 260° C PEAK TEMPERATURE FOR WAVE SOLDER PROCESS.
- ③ PIN MATERIAL: PHOS BRONZE.
- ④ MEASURED WITH PART IN RESTRAINED CONDITION.
- ⑤ TWO SIDES OF PIN TIPS NOT PLATED. TYPICAL BOTH ENDS.
- ⑥ 2LBS/0.9KG MIN PIN RETENTION IN EITHER DIRECTION.
- ⑦ MILITARY BERGSTRIIP HEADER
 P/N XXXXX-XY-MIL
 NOT AVAILABLE.
- ⑧ ±.010/0.25 TOL APPLIES TO ALL "G" TAILS EXCEPT INDICATED PARTS ON TABLE WHERE +.010/0.25 -.000/0.00 APPLIES.
- ⑨ NOTCH CONFIGURATION WILL VARY PER VENDOR'S DISCRETION.
- ⑩ BERGSTRIIP™ PART NUMBERS FOLLOWED BY BY A "B" ARE BULK PRICED.
- ⑪ TAIL LENGTH (DIM. G) TO BE ±.008/.020.
- ⑫ POSITIONS PER ROW 37 TO 50 CAN BE PRODUCED, BUT FLATNESS AND CURVATURE MAY NOT BE HELD AS CLOSE AS 36 POSITIONS.
- ⑬ THESE PRODUCTS MEETS EUROPEAN UNION DIRECTIVES AND OTHER COUNTRY REGULATION AS DESCRIBED IN GS-22-008.
- ⑭ PLATING OPTIONS:
 MAY BE EITHER GOLD OR GXT PLATED AT MANUFACTURER'S OPTION.
- ⑮ "THIS PRODUCT HAS 100% TIN PLATING IN THE INTERFACE AND HAS NOT BEEN TESTED FOR WHISKER GROWTH IN ALL INTERCONNECT ENVIRONMENTS."



mat'l. code NOTE 2 & 3				tolerances unless otherwise specified				CUSTOMER COPY		 www.fciconnect.com	
ltr	ecn no	dr	date	linear	.xx±.01/.x±.3			projection 	title BERGSTRIIP® II HDR. D/R .100/2.54cc STRAIGHT		
cv					.xxx±.005/.xx±.13				 INCH/MM scale 1:1	product family BERGSTRIIP	
				angles	.xxx±.0020/.xxx±.051			size dwg no		213	
				dr	T.BREWBAKER	12/21/94		A		67996	sheet
				enrg	T.HANNA	12/21/94				2 of 8	
				chr	T.HANNA	12/21/94					
				appd	T.HANNA	12/21/94					
sheet index	revision sheet										

Tous droits strictement reserves. Reproduction ou communication a des tiers interdite sous quelque forme que ce soit sans autorisation ecrite du proprietaire. Propriete de c FCI. Droits de reproduction FCI.

All rights strictly reserved. Reproduction or issue to third parties in any form whatever is not permitted without written authority from the proprietor. Property of FCI. Copyright FCI.

FCI

BERGSTRIK™ HEADER

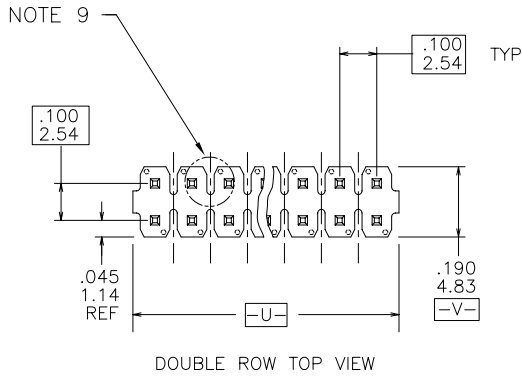

DOUBLE ROW TOP VIEW

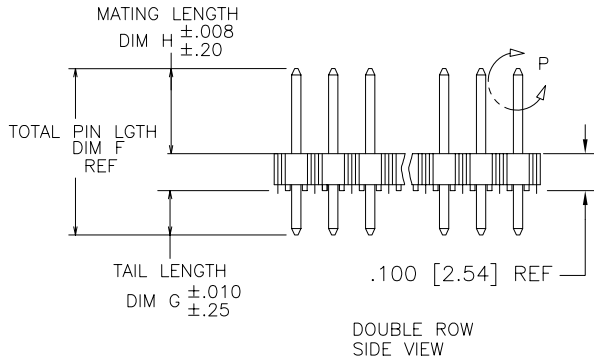

DOUBLE ROW SIDE VIEW

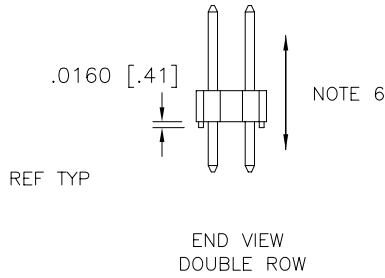

REF TYP

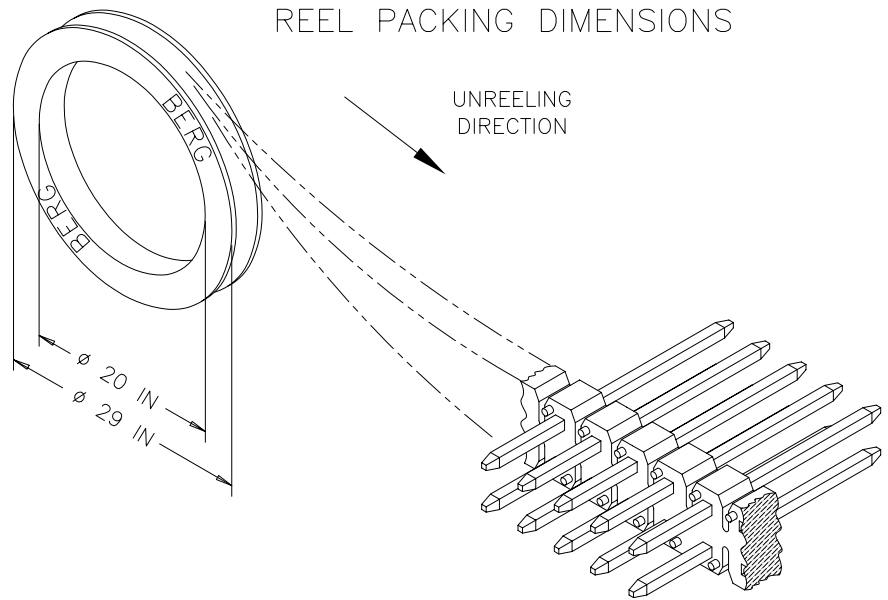



mat'l. code NOTE 2 & 3				tolerances unless otherwise specified		CUSTOMER COPY	FCI www.fciconnect.com
ltr	ecn no	dr	date	linear	.xxx±.01/.x±.3		
cv				angles	.xxx±.005/.xx±.13 .xxxx±.0020/.xxx±.051	INCH/MM 	product family BERGSTRIK code 213
				dr	T.BREWBAKER 12/21/94		
				enr	T.HANNA 12/21/94	sheet 3 of 8	
				chr	T.HANNA 12/21/94		
				appd	T.HANNA 12/21/94		
sheet index	revision sheet						

Tous droits strictement reserves. Reproduction ou communication a des tiers interdite sous quelque forme que ce soit sans autorisation ecrite du proprietaire. Propriete de c FCI. Droits de reproduction FCI.

All rights strictly reserved. Reproduction or issue to third parties in any form whatever is not permitted without written authority from the proprietor. Property of FCI. Copyright FCI.

PRODUCT NUMBER	TOT. PIN LGTH.		TAIL LENGTH		MATING LENGTH		PACKAGING	NOTES	BERGSTRIK™ AVAILABLE	LF OPTION
	DIM F	DIM F	DIM G	DIM G	DIM H	DIM H				
	ENGLISH	METRIC	ENGLISH	METRIC	ENGLISH	METRIC				
55005-YYYH	0.597	15.16	0.095	2.41	0.402	10.21	POLY BAGS	-	YES	NOTE 1,13
55030-YYYH	0.630	16.00	0.150	3.81	0.380	9.65	POLY BAGS	-	YES	
67996-YYY	0.425	10.80	0.095	2.41	0.230	5.84	POLY BAGS/TUBES	-	YES	
67997-YYY	0.450	11.43	0.120	3.05	0.230	5.84	POLY BAGS/TUBES	-	YES	
67997-YYYH	0.450	11.43	0.120	3.05	0.230	5.84	POLY BAGS/TUBES	-	YES	
67998-YYY	0.525	13.34	0.107	2.72	0.318	8.08	POLY BAGS/TUBES	-	YES	
67999-YYY	0.548	13.92	0.130	3.30	0.318	8.08	POLY BAGS	-	NO	
68438-YYY	0.555	14.10	0.225	5.72	0.230	5.84	POLY BAGS/TUBES	-	NO	
68439-YYY	0.720	18.29	0.120	3.05	0.500	12.70	POLY BAGS	-	NO	
68464-YYY	0.650	16.51	0.120	3.05	0.430	10.92	POLY BAGS/TUBES	-	NO	
68481-YYY	0.480	12.19	0.095	2.41	0.285	7.24	POLY BAGS/TUBES	-	NO	
68482-YYY	0.938	23.83	0.318	8.08	0.520	13.21	POLY BAGS	-	NO	
68491-YYY	0.475	12.07	0.120	3.05	0.255	6.48	POLY BAGS/TUBES	-	NO	
68600-YYY	0.825	20.96	0.115	2.92	0.610	15.49	POLY BAGS	-	NO	
68601-YYY	0.620	15.75	0.120	3.05	0.400	10.16	POLY BAGS	-	NO	
68602-YYY	0.480	12.19	0.150	3.81	0.230	5.84	POLY BAGS	-	NO	
68690-YYY	0.533	13.54	0.115	2.92	0.318	8.08	POLY BAGS	-	NO	
68691-YYY	0.538	13.67	0.120	3.05	0.318	8.08	POLY BAGS	-	YES	
68692-YYY	0.430	10.92	0.100	2.54	0.230	5.84	POLY BAGS	-	NO	
68693-YYY	0.938	23.83	0.520	13.21	0.318	8.08	POLY BAGS	-	NO	
68716-YYY	0.828	21.03	0.410	10.41	0.318	8.08	POLY BAGS	-	NO	
68734-YYY	0.615	15.62	0.230	5.84	0.285	7.24	POLY BAGS	-	NO	
68737-YYY	0.440	11.18	0.110	2.79	0.230	5.84	POLY BAGS	-	YES	
68738-YYY	0.615	15.62	0.115	2.92	0.400	10.16	POLY BAGS	-	NO	
68739-YYY	0.486	12.34	0.156	3.96	0.230	5.84	POLY BAGS	-	NO	
68743-YYY	0.638	16.21	0.220	5.59	0.318	8.08	POLY BAGS	-	NO	
68749-YYY	0.838	21.29	0.420	10.67	0.318	8.08	POLY BAGS	-	NO	
68779-YYY	0.736	18.69	0.318	8.08	0.318	8.08	POLY BAGS	-	NO	
68783-YYY	0.375	9.53	0.045	1.14	0.230	5.84	POLY BAGS	-	NO	
68799-YYY	0.925	23.50	0.595	15.11	0.230	5.84	POLY BAGS	-	NO	

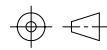
NOTE 1,13

mat'l. code NOTE 2 & 3				tolerances unless otherwise specified				CUSTOMER COPY		 www.fciconnect.com	
ltr	ecn no	dr	date	linear	.xx±.01/.X±.3			projection 	title BERGSTIK® II HDR. D/R		
cv					.xxx±.005/.XX±.13				.100/2.54cc STRAIGHT		
					.xxxx±.0020/.XXX±.051				product family BERGSTIK		
				angles	σ±2'			INCH/MM 	code 213		
				dr	T.BREWBAKER	12/21/94	scale 1:1		size A 67996		
				enr	T.HANNA	12/21/94		sheet 4 of 8			
				chr	T.HANNA	12/21/94					
				appd	T.HANNA	12/21/94					
sheet index	revision sheet										

Tous droits strictement reserves. Reproduction ou communication a des tiers interdite sous quelque forme que ce soit sans autorisation ecrite du proprietaire. Propriete de c FCI. Droits de reproduction FCI.

All rights strictly reserved. Reproduction or issue to third parties in any form whatever is not permitted without written authority from the proprietor. Property of FCI. Copyright FCI.

PRODUCT NUMBER	TOT. PIN LGTH.		TAIL LENGTH		MATING LENGTH		PACKAGING	NOTES	BERGSTRIPTM AVAILABLE	LF OPTION
	DIM F	DIM F	DIM G	DIM G	DIM H	DIM H				
	ENGLISH	METRIC	ENGLISH	METRIC	ENGLISH	METRIC				
69132-XYY	0.760	19.30	0.120	3.05	0.540	13.72	POLY BAGS/TUBES	-	NO	NOTE 1,13
69133-XYY	0.615	15.62	0.285	7.24	0.230	5.84	POLY BAGS	-	NO	
69157-XYY	0.410	10.41	0.110	2.79	0.200	5.08	POLY BAGS	-	NO	
71217-XYYH	1.000	25.40	0.450	11.43	0.450	11.43	POLY BAGS	-	NO	
71222-XYYH	0.850	21.59	0.250	6.35	0.500	12.70	POLY BAGS	-	NO	
72273-XYYH	0.725	18.42	0.110	2.79	0.515	13.08	POLY BAGS	-	NO	
72448-XYYH	0.658	16.71	0.172	4.37	0.386	9.80	POLY BAGS	-	NO	
72455-XYYH	0.598	15.19	0.180	4.57	0.318	8.08	POLY BAGS	-	NO	
72455-632HG	0.598	15.19	0.180	4.57	0.318	8.08	GPAX	NOTE 1	NO	
73503-XYYH	0.420	10.67	0.120	3.05	0.200	5.08	POLY BAGS	-	NO	
73596-XYYH	0.795	20.19	0.110	2.79	0.585	14.86	POLY BAGS	-	NO	
74317-XYYH	0.532	13.51	0.309	7.85	0.123	3.12	POLY BAGS	NOTE 11	NO	
74318-XYYH	0.592	15.04	0.369	9.37	0.123	3.12	POLY BAGS	NOTE 11	NO	
74999-XYYH	0.508	12.90	0.090	2.29	0.318	8.08	POLY BAGS	-	NO	
78212-XYY	0.710	18.03	0.350	8.89	0.260	6.60	POLY BAGS	-	NO	
78233-XYY	0.568	14.43	0.150	3.81	0.318	8.08	POLY BAGS	-	NO	
78269-XYY	0.385	9.78	0.095	2.41	0.190	4.83	POLY BAGS	-	NO	
78286-XYY	0.500	12.70	0.160	4.06	0.240	6.10	POLY BAGS/TUBES	-	NO	
78932-XYY	UNAVAILABLE		UNAVAILABLE		UNAVAILABLE			-	-	
78933-XYY	0.695	17.65	0.285	7.24	0.310	7.87	POLY BAGS	-	NO	
78988-XYY	0.540	13.72	0.135	3.43	0.305	7.75	POLY BAGS	-	NO	
78989-XYY	UNAVAILABLE		UNAVAILABLE		UNAVAILABLE			-	-	
78990-XYY	UNAVAILABLE		UNAVAILABLE		UNAVAILABLE			-	-	
78991-XYY	UNAVAILABLE		UNAVAILABLE		UNAVAILABLE			-	-	
78992-XYY	UNAVAILABLE		UNAVAILABLE		UNAVAILABLE			-	-	
78993-XYY	UNAVAILABLE		UNAVAILABLE		UNAVAILABLE			-	-	
78994-XYY	UNAVAILABLE		UNAVAILABLE		UNAVAILABLE			-	-	

NOTE 1,13

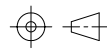
mat'l. code NOTE 2 & 3				tolerances unless otherwise specified				CUSTOMER COPY		 www.fciconnect.com	
ltr	ecn no	dr	date	linear	.XX ±0.01/0.3		projection		title		
cv					.XXX ±0.005/0.13				BERGSTIK® II HDR. D/R		
				angles	.XXXX ±0.0020/0.051		INCH/MM	.100/2.54cc STRAIGHT			
					0° ±2°			product family		BERGSTIK	
				dr	T.BREWBAKER	12/21/94	scale	A	size		code
				enr	T.HANNA	12/21/94			67996		213
				chr	T.HANNA	12/21/94			5 of 8		
				appd	T.HANNA	12/21/94					
sheet index	revision sheet										

Tous droits strictement reserves. Reproduction ou communication a des tiers interalite sous quelque forme que ce soit sans autorisation ecrite du proprietaire. Propriete de c FCI. Droits de reproduction FCI.

A
FCI

All rights strictly reserved. Reproduction or issue to third parties in any form whatever is not permitted without written authority from the proprietor. Property of FCI. Copyright FCI.

B

1 | 2

3 |

4

PRODUCT NUMBER	TOT. PIN LGTH.		TAIL LENGTH		MATING LENGTH		PACKAGING	NOTES	BERGSTRIPTM AVAILABLE	LF OPTION
	DIM F	DIM F	DIM G	DIM G	DIM H	DIM H				
	ENGLISH	METRIC	ENGLISH	METRIC	ENGLISH	METRIC				
78995-YYY		UNAVAILABLE		UNAVAILABLE		UNAVAILABLE		-	-	NOTE 1,13
78996-YYY		UNAVAILABLE		UNAVAILABLE		UNAVAILABLE		-	-	
79242-YYY	0.930	23.62	0.340	8.64	0.490	12.45	POLY BAGS	-	NO	
79243-YYY	1.230	31.24	0.390	9.91	0.740	18.80	POLY BAGS	-	NO	
79244-YYY		UNAVAILABLE		UNAVAILABLE		UNAVAILABLE		-	-	
79268-YYY	1.020	25.91	0.120	3.05	0.800	20.32	POLY BAGS	-	NO	
79271-YYY	1.100	27.94	0.500	12.70	0.500	12.70	POLY BAGS	-	NO	
79425-YYY	0.410	10.41	0.120	3.05	0.190	4.83	POLY BAGS	-	NO	
79821-YYY	0.730	18.54	0.200	5.08	0.430	10.92	POLY BAGS	-	NO	
84610-YYYH	0.380	9.65	0.120	3.05	0.160	4.06	POLY BAGS	-	NO	
84760-YYYH	0.870	22.09	0.150	3.81	0.620	15.74	POLY BAGS	-	NO	
84784-YYYH	1.130	28.70	0.122	3.09	0.908	23.06	POLY BAGS	-	NO	
84934-YYYH	1.375	34.93	0.625	15.88	0.650	16.51	POLY BAGS	-	NO	
84976-YYYH	0.730	18.54	0.400	10.16	0.230	5.84	POLY BAGS	-	NO	
86503-YYY	0.470	11.94	0.120	3.05	0.250	6.35	POLY BAGS	-	NO	
86581-YYY	0.450	11.43	0.120	3.05	0.230	5.84	POLY BAGS	NOTE 8	NO	
86817-YYY	0.925	23.50	0.120	3.05	0.705	17.91	POLY BAGS	-	NO	
86827-YYY	0.700	17.78	0.120	3.05	0.480	12.19	POLY BAGS	-	NO	
86832-YYY	0.525	13.34	0.100	2.54	0.325	8.26	POLY BAGS	-	NO	
86834-YYY	1.335	33.91	0.585	14.86	0.650	16.51	POLY BAGS	-	NO	
86836-YYY	0.870	22.10	0.120	3.05	0.650	16.51	POLY BAGS	-	NO	
86837-YYY	0.600	15.24	0.120	3.05	0.380	9.65	POLY BAGS	-	NO	
87037-YYY	1.240	31.50	0.120	3.05	1.020	25.91	POLY BAGS	-	NO	
87052-YYY	0.990	25.15	0.120	3.05	0.770	19.56	POLY BAGS	-	NO	
87203-YYY	0.545	13.84	0.150	3.81	0.295	7.49	POLY BAGS	-	NO	
87344-YYY	1.375	34.93	0.219	5.56	1.056	26.82	POLY BAGS	-	NO	

NOTE 1,13

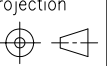
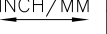
mat'l. code NOTE 2 & 3				tolerances unless otherwise specified		CUSTOMER COPY		 www.fciconnect.com			
ltr	ecn no	dr	date	linear	.XX ±.01/0.3	projection		title			
cv					.XXX ±.005/0.13			BERGSTIK® II HDR. D/R		code	
				angles	.XXXX ±.0020/0.051	INCH/MM		.100/2.54cc STRAIGHT			
				dr	0° ±2'			product family BERGSTIK		sheet	
				enr	T.BREWBAKER 12/21/94	scale	1:1	size/ dwg no			
				chr	T.HANNA 12/21/94			A 67996		213	
				appd	T.HANNA 12/21/94					6 of 8	
sheet index	revision sheet										

1 | 2

3 |

4

ACAD

PDM: Rev:CV

STATUS Released

Printed: Jul 24, 2005

cage code
22526

PRODUCT NUMBER	TOT. PIN LGTH.		TAIL LENGTH		MATING LENGTH		PACKAGING	NOTES	BERGSTRIPTM AVAILABLE	LF OPTION
	DIM F	DIM F	DIM G	DIM G	DIM H	DIM H				
	ENGLISH	METRIC	ENGLISH	METRIC	ENGLISH	METRIC				
87345-XYY	1.218	30.94	0.406	10.31	0.712	18.08	POLY BAGS	-	NO	NOTE 1,13
87348-XYY	0.930	23.62	0.100	2.54	0.730	18.54	POLY BAGS	-	NO	
87349-XYY	0.890	22.61	0.110	2.79	0.680	17.27	POLY BAGS	-	NO	
87381-XYY	0.645	16.38	0.100	2.54	0.445	11.30	POLY BAGS	-	NO	
87382-XYY	0.675	17.15	0.100	2.54	0.475	12.07	POLY BAGS	-	NO	
87503-XYYH	0.630	16.00	0.110	2.79	0.420	10.67	POLY BAGS	-	NO	
87869-XYY	0.690	17.53	0.230	5.84	0.360	9.14	POLY BAGS	-	NO	
87894-XYY	0.588	14.94	0.170	4.32	0.318	8.08	POLY BAGS	-	NO	
87900-XYY	0.940	23.88	0.120	3.05	0.720	18.29	POLY BAGS	-	NO	
87901-XYY	1.040	26.42	0.120	3.05	0.820	20.83	POLY BAGS	-	NO	
87903-XYY	0.963	24.46	0.337	8.56	0.526	13.36	POLY BAGS	-	NO	
88797-XYY	0.950	24.13	0.320	8.13	0.530	13.46	POLY BAGS	-	NO	
88812-XYY	0.415	10.54	0.085	2.16	0.230	5.84	POLY BAGS/TUBES	NOTE 8	NO	
88886-XYY	1.306	33.17	0.276	7.01	0.930	23.62	POLY BAGS	-	NO	
89446-XYY	0.930	23.62	0.120	3.05	0.710	18.03	POLY BAGS	-	NO	
89540-XYY	0.760	19.30	0.280	7.11	0.380	9.65	POLY BAGS	-	NO	
89542-XYY	1.065	27.05	0.125	3.18	0.840	21.34	POLY BAGS	-	NO	
89639-XYY	1.260	32.00	0.118	3.00	1.042	26.47	POLY BAGS	-	NO	
91828-XYY	0.450	11.43	0.120	3.05	0.230	5.84	TUBES	-	NO	
92417-XYY	0.530	13.46	0.110	2.79	0.320	8.13	POLY BAGS	-	NO	
93216-XYYH	0.573	14.55	0.155	3.94	0.318	8.08	POLY BAGS/TUBES	-	NO	
93216-632HG	0.573	14.55	0.155	3.94	0.318	8.08	GPAX	NOTE 1	NO	
93217-XYYH	0.395	10.03	0.095	2.41	0.200	5.08	POLY BAGS	-	NO	
93254-XYY	0.563	14.30	0.110	2.79	0.353	8.97	POLY BAGS	-	NO	

Tous droits strictement reserves. Reproduction ou communication a des tiers interdite sous quelque forme que ce soit sans autorisation ecrite du proprietaire. Propriete de c FCI. Droits de reproduction FCI.



All rights strictly reserved. Reproduction or issue to third parties in any form whatever is not permitted without written authority from the proprietor. Property of FCI. Copyright FCI.

mat'l. code NOTE 2 & 3				tolerances unless otherwise specified				CUSTOMER COPY		www.fciconnect.com		
ltr	ecn no	dr	date	linear	.XX ±0.01/0.3		projection 	title BERGSTIK® II HDR. D/R .100/2.54cc STRAIGHT		product family BERGSTIK		code
cv					.XXX ±0.005/0.13					INCH/MM		size
				angles	.XXXX ±0.0020/0.051		scale 1:1	A		67996		sheet
				dr	T.BREWBAKER	12/21/94				7 of 8		
				enr	T.HANNA	12/21/94						
				chr	T.HANNA	12/21/94						
				appd	T.HANNA	12/21/94						
sheet index	revision sheet											

All rights strictly reserved. Reproduction or issue to third parties in any form whatever is not permitted without written authority from the proprietor. Property of FCI. Copyright FCI.

Tous droits strictement reserves. Reproduction ou communication a des tiers interdite sous quelque forme que ce soit sans autorisation ecrite du proprietaire. Propriete de c FCI. Droits de reproduction FCI.



1 | 2

3

4

PRODUCT NUMBER	TOT. PIN LGTH.		TAIL LENGTH		MATING LENGTH		PACKAGING	NOTES	BERGSTRIPTM AVAILABLE	LF OPTION
	DIM F	DIM F	DIM G	DIM G	DIM H	DIM H				
	ENGLISH	METRIC	ENGLISH	METRIC	ENGLISH	METRIC				
94010-XYYH	0.756	19.20	0.350	8.89	0.306	7.77	POLY BAGS	-	NO	NOTE 1,13 ↓ NOTE 1,13
94532-XYYH	1.250	31.75	0.450	11.43	0.700	17.78	POLY BAGS	-	NO	
95105-XYY	0.370	9.40	0.126	3.20	0.144	3.66	POLY BAGS	-	NO	
95645-XYYH	0.350	8.89	0.100	2.54	0.150	3.81	POLY BAGS	-	NO	
95652-XYYH	0.500	12.70	0.070	1.78	0.330	8.38	POLY BAGS	-	NO	
95665-XYYH	0.835	21.21	0.335	8.51	0.400	10.16	POLY BAGS	-	NO	
95687-XYYH	0.820	20.83	0.360	9.14	0.360	9.14	POLY BAGS	-	NO	
95712-XYYH	1.090	27.69	0.110	2.79	0.880	22.35	POLY BAGS	-	NO	
95727-XYYH	0.825	20.96	0.110	2.79	0.615	15.62	POLY BAGS	-	NO	
98181-XYYH	0.760	19.30	0.218	5.54	0.442	11.23	POLY BAGS	-	NO	
98217-XYYH	0.756	19.20	0.328	8.33	0.328	8.33	POLY BAGS	-	NO	
98329-XYYH	0.930	23.62	0.415	10.54	0.415	10.54	POLY BAGS	-	NO	
98854-XYYH	0.450	11.43	0.120	3.05	0.230	5.84	TUBES	-	NO	
10017852-XYYH	0.450	11.43	0.125	3.18	0.225	5.72	POLYBAGS	-	NO	

A

A

mat'l. code NOTE 2 & 3				tolerances unless otherwise specified				CUSTOMER COPY		www.fciconnect.com	
ltr	ecn no	dr	date	linear	.XX ±0.01/0.3			projection 	title BERGSTIK® II HDR. D/R		
cv					.XXX ±0.005/0.13				.100/2.54cc STRAIGHT		
					.XXXX ±0.0020/0.051				product family BERGSTIK		
				angles	0° ±2°			INCH/MM ↔	code 213		
				dr	T.BREWBAKER	12/21/94	scale 1:1		size		sheet 8 of 8
				enr	T.HANNA	12/21/94		A 67996			
				chr	T.HANNA	12/21/94					
				appd	T.HANNA	12/21/94					
sheet index	revision sheet										

B

B

1 | 2

3

4

ACAD

PDM: Rev:CV

STATUS Released

Printed: Jul 24, 2005

cage code
22526

X-ON Electronics

Largest Supplier of Electrical and Electronic Components

Click to view similar products for [Headers & Wire Housings](#) category:

Click to view products by [Amphenol](#) manufacturer:

Other Similar products are found below :

[892-18-020-10-001101](#) [58102-G61-06LF](#) [582553-1](#) [0009485154](#) [009176003701906](#) [0050291907](#) [LY20-4P-DT1-P1E-BR](#) [02.125.8002.8](#)
[609-3404](#) [61062-3](#) [622-0430](#) [622-3653LF](#) [63453-116](#) [636-1030](#) [636-1427](#) [636-3427](#) [636-4007](#) [641938-9](#) [641991-4](#) [644827-2](#) [65817-010LF](#)
[65817-015LF](#) [65863-015LF](#) [66207-023LF](#) [67095-007LF](#) [67601157](#) [68648-049](#) [70.362.1628.0](#) [70-4210](#) [70-4226B](#) [70-4853B](#) [707-5020](#) [707-](#)
[5028](#) [71.350.2428.0](#) [71918-208LF](#) [71961-016LF](#) [733-134](#) [733-162](#) [754199-000](#) [760-3052](#) [787-8014-00](#) [79531-3000](#) [FCN-360C032-B](#) [FCN-](#)
[367T-T012/H](#) [FCN-723D010/2](#) [80.063.4001.1](#) [800-90-001-10-001000](#) [800-90-010-10-002000](#) [801-43-002-10-013000](#) [801-43-006-10-002000](#)