

Amphenol® QWL Series Cylindrical Connectors

12-053-4



Amphenol

TABLE OF CONTENTS

| <i>Description</i> | <i>Page</i> | <i>Description.....</i> | <i>Page</i> |
|--|-------------|--|-------------|
| Amphenol® Heavy Duty Cylindrical Connectors | | QWL - accessories | |
| QWL Series | 2 | 10-130380 cable sealing adapter (with clamp bars) | 43, 44 |
| QWL the environmental connector | 3 | QWL - accessories 10-10133X cable sealing adapters | 45-48 |
| QWL how to order | 4, 5 | QWL - accessories 10-113637 cable sealing adapter (with woven strain relief) | 49-52 |
| QWL 10-1070 wall mount receptacle | 6 | QWL - accessories adapter, cable clamp | 53 |
| QWL 10-1071 cable connecting plug | 7 | QWL - accessories adapter, cable clamp, sealing plugs | 54-56 |
| QWL 10-1072 box mount receptacle | 8 | QWL - accessories protection caps | 57, 58 |
| QWL 10-1073 jam nut receptacle (wall mount) | 9 | QWL - accessories flange gasket, grip banding clamp | 59 |
| QWL 10-1074 thru bulkhead receptacle | 10 | QWL crimp contacts | 60 |
| QWL 10-1076 straight plug | 11 | QWL solder contacts | 61 |
| QWL 10-1077 flange mount plug | 12 | QWL application tools (crimp type) | 62 |
| QWL 10-1079 jam nut receptacle (box mount) | 13 | QWL thermocouple contacts and arrangements | 63-69 |
| QWL insert arrangements selection guide | 14-16 | Other Heavy Duty Connectors Offered by Amphenol | 70 |
| QWL alternate positioning | 17 | Sales Office Listing | |
| QWL contact insert arrangements | 18-29 | | |
| QWL special contact insert arrangements | 30-40 | | |
| QWL - accessories cabling information | 41, 42 | | |

Amphenol Aerospace operates Quality Systems that are Certified to ISO-9001 and AS-9100 by third party Registrars.

For additional information concerning the Amphenol® QWL Series Cylindrical Connector, or if there are special application requirements, contact your local sales office or

Amphenol Corporation
Amphenol Aerospace
40-60 Delaware Ave.
Sidney, New York 13838-1395
Telephone: 607-563-5011
Fax: 607-563-5351
www.amphenol-aerospace.com
(Most Amphenol catalogs can be viewed, printed and down-loaded from the website)

Amphenol® Heavy Duty Cylindrical Connectors

QWL Series



wall mount receptacle



thru bulkhead receptacle



cable connecting plug



straight plug



box mount receptacle



flange mount plug



jam nut receptacle
(wall mount)



jam nut receptacle
(box mount)

Amphenol® QWL Series Connectors are tailor made for compact, heavy duty industrial use.

The outstanding performance of this series makes it well suited for ship-board installations and ground support power distribution applications where physical strength and dependability are key requirements.

The QWL Series are a versatile, economical alternative to military qualified designs.

Equivalent MS shell sizes and insert arrangements offer compatibility with all standard cable types. MIL-C-22992 environmental connector requirements (see page 1) are used as a performance criteria base for this series to assure reliability under the most severe conditions.

The design features of this connector series provide:

- **Exceptional Service** - high strength aluminum shells with Alumilite 225* hard anodic finish and shock resistant resilient inserts.
- **Foolproof Operation** - rugged double stub coupling threads, left hand accessory threads and simple single keyway mating.
- **Versatility** - both MS and custom insert patterns available for a wide variety of multiconductor cables.

A complete line of accessories is available for use with QWL Series connectors, including cable sealing and clamp adapters, protective covers, flange gaskets and banding clamps.

* Registered trademark of Aluminum Company of America

QWL

the environmental connector

- **HIGH CURRENT CAPACITY** for power distribution network and inputs to large equipment
- **RUGGED CONSTRUCTION** dictated by the working environment, high strength aluminum shells with Alumilite 225* hard anodic finish, shock resistant resilient inserts, gaskets or “O” rings at appropriate surfaces for perfect weather tight connections.
- **SERVICEABILITY AND FOOL-PROOF OPERATION** with fast coupling, easily maintained double stub threads, left hand accessory threads and single keyway mating.
- **VERSATILITY** - both MS and custom insert patterns available to accommodate a wide variety of multi conductor cables.

| CONDITION | CONFIGURATION | DESCRIPTION | REFERENCE |
|--|---------------|---|---|
| THERMAL SHOCK | UNMATED | Five complete one hour temperature cycles of -55°C to +125°C | MIL-STD-1344 method 1003 test condition |
| MOISTURE RESISTANCE (Cable mounted connectors) | MATED | Ten complete 24 hour cycles of +25°C to +65°C temperature at 90% to 98% humidity | MIL-STD-202 method 106 |
| DURABILITY | MATED | 500 complete mating/unmating cycles | MIL-C-22992 |
| SALT SPRAY (Corrosion) | UNMATED | 48 hour exposure to atomized 5% saline solution at +35°C | MIL-STD-1344 method 1001 |
| VIBRATION | MATED | 10 to 55 Hz, .06 inch total excursion in 1 minute cycles for 6 hours 55 to 2000 Hz, 10G peak amplitude sweep | MIL-STD-1344 method 2005 |
| HIGH IMPACT | MATED | Nine hammer blows from 1, 3 and 5 feet, three each in three axes on mounting panel | MIL-STD-202 method 207 |
| FLUID IMMERSION | UNMATED | 20 hours immersion in hydraulic fluid and lubricating oil | MIL-C-22992 |
| WATER IMMERSION | MATED | 4 hours immersion at 1 atmosphere pressure differential | MIL-C-22992 |

* Registered trademark of Aluminum Company of America

QWL

how to order

QWL heavy duty cylindrical connectors are ordered by Amphenol® part number only. To illustrate the ordering procedure, part number 10-107628-5P is shown as follows:

PART NUMBER
 $\frac{10}{1} - \frac{107}{2} \frac{6}{3} \frac{28-5}{4} \frac{P}{5}$

See code below:

1. Base Number Prefix - used to define contact type and finish.

- 10- Solder type contacts, silver plated (Standard)
- 75- Crimp type contacts, silver plated
- 81- Crimp type contacts, plated .0001 gold over silver
- 82- Crimp type contacts for MIL-C-13777 cable, silver plated
- 83- Crimp type contacts for MIL-C-13777 cable, plated .0001 gold over silver
- 85- Crimp type contacts plated .00005 gold over silver

2. Base Number - QWL Series Heavy Duty Cylindrical Connector.

3. Shell Style -

- 0 designates wall mount receptacle
- 1 designates cable connecting plug
- 2 designates box mount receptacle
- 3 designates jam nut receptacle with rear accessory threads (wall mount)
- 4 designates thru bulkhead receptacle
- 6 designates straight plug
- 7 designates flange mount plug
- 9 designates jam nut receptacle (box mount)

4. Shell Size/Insert Arrangement - Amphenol® QWL connectors are available in equivalent MS shell sizes with all current MS insert arrangements as well as a large selection of special arrangements for power and signal circuits. Select the required insert arrangement number from those shown on pages 18-40.

5. Contact Type/Alternate Insert Rotations - P for pin, S for socket. When an alternate position of the connector insert is required to prevent cross mating of connectors, a different letter (other than P or S) is used. Select from the table below the Amphenol® letter which indicates both type of contact, and insert rotation desired. Refer to page 17 for alternate insert rotations.

| PIN CONTACTS | | SOCKET CONTACTS | |
|--------------|------------------|-----------------|------------------|
| MS LETTERS | AMPHENOL® LETTER | MS LETTERS | AMPHENOL® LETTER |
| P | P (normal) | S | S (normal) |
| PW | G | SW | H |
| PX | I | SX | J |
| PY | K | SY | L |
| PZ | M | SZ | N |

QWL

how to order, cont.

ACCESSORIES

Cable Sealing Adapters - these are the basic connector accessories which provide moisture proofing and cable strain relief. Selection is made on the basis of accessory style, shell size and cable dimensions. To illustrate the ordering procedure, part number 10-101335-361 is shown as follows:

PART NUMBER
10 - 101335 - 361
 1 2

See code below:

- 1. Accessory Base Number** - refer to pages 41 through 52 for descriptions and dimensional data. 10-101332 designates short barrel length with woven strain relief grip
- 10-101333 designates short barrel length without strain relief
 - 10-101334 designates short barrel length with woven strain relief grip and attaching ring for protection cap with bead chain
 - 10-101335 designates short barrel length with attaching ring for protection cap with bead chain
 - 10-101380 designates short barrel length with attaching ring for protection cap with bead chain and clamp type strain relief bars
 - 10-113637 designates long barrel length with woven strain relief and attaching ring for protection cap with bead chain

2. Part Number – represents connector shell size and range of cable diameters accommodated by the sealing adapter. Refer to the page listed below to determine the part number required for the accessory style being used:

| Accessory Series | Page |
|------------------|---------|
| 10-10133X | 46 - 48 |
| 10-130380 | 44 |
| 10-113637 | 50 - 52 |

Cable Clamp 10-749XX-() and Adapter 10-113196-XX

Connectors which require weatherproofing on open wire cables are provided with a moisture seal by this cable clamp, a modification of the MS3057B design. A rubber grommet with holes for individual wires is used in place of the sleeve. As the assembly is tightened, the grommet is compressed around each wire, sealing out moisture.

Order this clamp by the part number listed on page 53 to accommodate the connector being used. Suffix the part number with the connector insert arrangement number.

To attach the cable clamp to the left hand accessory threads of QWL connectors, Adapter 10-113196-XX is needed. Finish is non-conductive Alumilite. Order by adapter part number listed on page 53 to accommodate the connector shell size being used. For a moisture proof seal, unused grommet holes must be filled with the appropriate size sealing plug or sealing rod selected from the table on page 53. Sealing plug or sealing rods must be ordered separately.

M85049/1 Cable Clamp and Adapter 10-113138-XX - order this clamp by the M85049()C part number listed on page 55 to accommodate the cable type being used. To attach the cable clamp to the left hand accessory threads of QWL connectors, Adapter 10-113138-XX is needed. Order by adapter part number listed on page 55 to accommodate the connector shell size being used. Standard finish on the clamp is olive drab, cadmium plate. Adapter finish is non-conductive Alumilite. MS3420-()A sleeve, to facilitate sealing on smaller diameter cables, must be ordered separately. MS3420-()A sleeves may be nested to accommodate smaller cable diameters.

Plug Protection Caps -

- 10-101046-() designates plug cover with chain, Alumilite 225 finish
 - 10-101531-() designates plug cover with chain and eyelet end, Alumilite 225 finish
- Order these plug covers by the part number listed on page 57 for the appropriate connector shell size.

Receptacle Protection Caps -

- 10-101063-() designates receptacle cover with chain, Alumilite 225 finish
 - 10-101048-() designates receptacle cover with chain and eyelet, Alumilite 225 finish
- Order these receptacle covers by the part number listed on page 57 for the appropriate connector shell size.

Flange Gasket -

- 10-36675-() for operating temperature range -67° to +275°F
 - 10-40450-() for operating temperature range 0° to +257°F
- Order by part number listed on page 59 for appropriate connector shell size.

10-183249 Grip Banding Clamp - order this stainless steel clamp by part number listed on page 59 to accommodate cable diameter being used.

QWL 10-1070XX wall mount receptacle

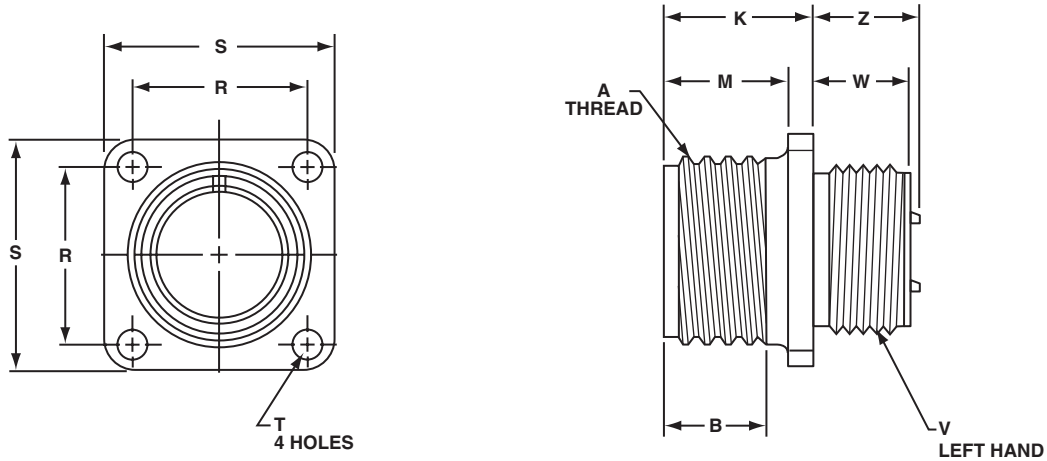

All dimensions for reference only.

| Part Number* | Shell Size | A Thread Class 2A | B Min Full Thread | K $\pm .015$ | M $+ .016$ $- .000$ | R $\pm .005$ | S $\pm .020$ | T Dia $+ .004$ $- .003$ | V Thread Class 2A-LH | W $\pm .010$ | Z Max |
|--------------|------------|---------------------|-------------------|--------------|---------------------|--------------|--------------|-------------------------|----------------------|--------------|-------|
| 10-107010 | 10S | .6250-0.05P-0.1L-DS | .391 | .704 | .562 | .719 | 1.000 | .150 | .500-28UNEF | .400 | .450 |
| 10-107012 | 12S | .7500-0.1P-0.2L-DS | .391 | .704 | .562 | .812 | 1.094 | .150 | .625-24UNEF | .400 | .450 |
| 10-107013 | 12 | .7500-0.1P-0.2L-DS | .625 | .891 | .750 | .812 | 1.094 | .150 | .625-24UNEF | .588 | .700 |
| 10-107014 | 14S | .8750-0.1P-0.2L-DS | .391 | .704 | .562 | .906 | 1.188 | .150 | .750-20UNEF | .400 | .450 |
| 10-107015 | 14 | .8750-0.1P-0.2L-DS | .625 | .891 | .750 | .906 | 1.188 | .150 | .750-20UNEF | .588 | .700 |
| 10-107016 | 16S | 1.0000-0.1P-0.2L-DS | .391 | .704 | .562 | .969 | 1.281 | .150 | .875-20UNEF | .400 | .450 |
| 10-107017 | 16 | 1.0000-0.1P-0.2L-DS | .625 | .891 | .750 | .969 | 1.281 | .150 | .875-20UNEF | .588 | .700 |
| 10-107018 | 18 | 1.1250-0.1P-0.2L-DS | .625 | .906 | .750 | 1.062 | 1.375 | .177 | 1.000-20UNEF | .573 | .686 |
| 10-107020 | 20 | 1.2500-0.1P-0.2L-DS | .625 | .906 | .750 | 1.156 | 1.500 | .177 | 1.125-18NEF | .573 | .686 |
| 10-107022 | 22 | 1.3750-0.1P-0.2L-DS | .625 | .906 | .750 | 1.250 | 1.625 | .177 | 1.250-18NEF | .573 | .686 |
| 10-107024 | 24 | 1.5000-0.1P-0.2L-DS | .625 | .968 | .812 | 1.375 | 1.750 | .177 | 1.375-18NEF | .573 | .624 |
| 10-107028 | 28 | 1.7500-0.1P-0.2L-DS | .625 | .968 | .812 | 1.562 | 2.000 | .177 | 1.625-18NEF | .573 | .624 |
| 10-107032 | 32 | 2.0000-0.1P-0.2L-DS | .625 | 1.031 | .875 | 1.750 | 2.250 | .209 | 1.875-16N | .573 | .561 |
| 10-107036 | 36 | 2.2500-0.1P-0.2L-DS | .625 | 1.031 | .875 | 1.938 | 2.500 | .209 | 2.0625-16N | .573 | .561 |
| 10-107040 | 40 | 2.5000-0.1P-0.2L-DS | .625 | 1.031 | .875 | 2.188 | 2.750 | .209 | 2.3125-16N | .573 | .561 |
| 10-107044 | 44 | 2.7500-0.1P-0.2L-DS | .625 | 1.031 | .875 | 2.375 | 3.000 | .209 | 2.625-16UN | .698 | .801 |

*For complete order number see page 4

QWL 10-1071XX cable connecting plug

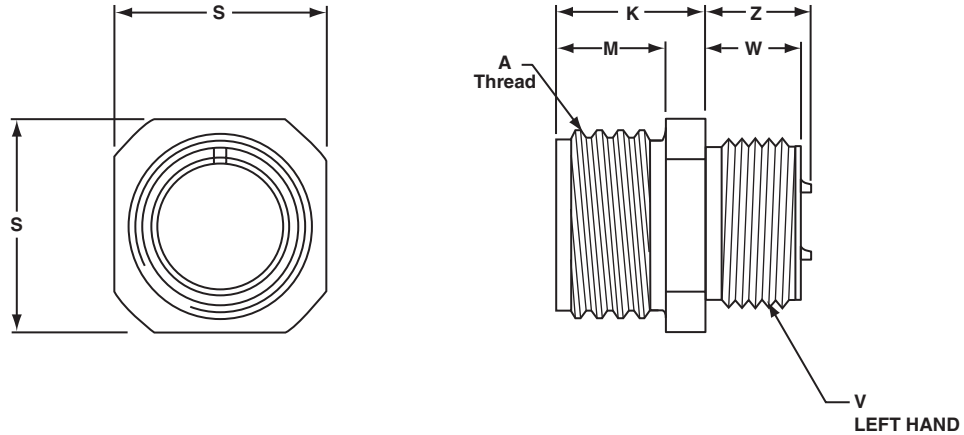

All dimensions for reference only.

| Part Number* | Shell Size | A Thread (plated) Class 2A | K $\pm .015$ | M $+.016$ $-.000$ | S $\pm .020$ | V Thread Class 2A-LH | W $\pm .010$ | Z Max |
|--------------|------------|----------------------------|--------------|----------------------|--------------|----------------------|--------------|-------|
| 10-107110 | 10S | .6250-0.05P-0.1L-DS | .704 | .453 | .750 | .500-28UNEF | .400 | .450 |
| 10-107112 | 12S | .7500-0.1P-0.2L-DS | .704 | .453 | .875 | .625-24UNEF | .400 | .450 |
| 10-107113 | 12 | .7500-0.1P-0.2L-DS | .891 | .641 | .875 | .625-24UNEF | .588 | .701 |
| 10-107114 | 14S | .8750-0.1P-0.2L-DS | .704 | .453 | 1.000 | .750-20UNEF | .400 | .450 |
| 10-107115 | 14 | .8750-0.1P-0.2L-DS | .891 | .641 | 1.000 | .750-20UNEF | .588 | .701 |
| 10-107116 | 16S | 1.0000-0.1P-0.2L-DS | .704 | .453 | 1.094 | .875-20UNEF | .400 | .450 |
| 10-107117 | 16 | 1.0000-0.1P-0.2L-DS | .891 | .641 | 1.094 | .875-20UNEF | .588 | .701 |
| 10-107118 | 18 | 1.1250-0.1P-0.2L-DS | .906 | .656 | 1.281 | 1.000-20UNEF | .573 | .686 |
| 10-107120 | 20 | 1.2500-0.1P-0.2L-DS | .906 | .656 | 1.375 | 1.125-18UNEF | .573 | .686 |
| 10-107122 | 22 | 1.3750-0.1P-0.2L-DS | .906 | .656 | 1.500 | 1.250-18UNEF | .573 | .686 |
| 10-107124 | 24 | 1.5000-0.1P-0.2L-DS | .968 | .719 | 1.625 | 1.375-18UNEF | .573 | .624 |
| 10-107128 | 28 | 1.7500-0.1P-0.2L-DS | .968 | .719 | 1.875 | 1.625-18UNEF | .573 | .624 |
| 10-107132 | 32 | 2.0000-0.1P-0.2L-DS | 1.031 | .656 | 2.125 | 1.875-16UN | .573 | .561 |
| 10-107136 | 36 | 2.2500-0.1P-0.2L-DS | 1.031 | .656 | 2.375 | 2.0625-16UNS | .573 | .561 |
| 10-107140 | 40 | 2.5000-0.1P-0.2L-DS | 1.031 | .656 | 2.625 | 2.3125-16UNS | .573 | .561 |
| 10-107144 | 44 | 2.7500-0.1P-0.2L-DS | 1.031 | .656 | 3.000 | 2.625-16UN | .698 | .800 |
| 10-107148 | 48 | 3.0000-0.1P-0.2L-DS | 1.031 | .656 | 3.125 | 2.875-16UN | .698 | .800 |

*For complete order number see page 4

QWL 10-1072XX

box mount receptacle

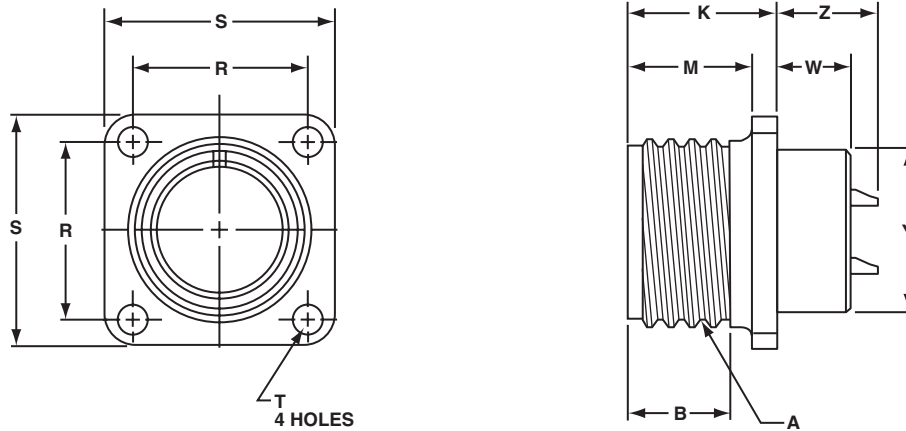

All dimensions for reference only.

| Part Number* | Shell Size | A Thread (Plated) Class 2A | B Min Full Thread | K $+0.026$ -0.010 | M $+0.016$ -0.000 | R ± 0.005 | S ± 0.020 | T Dia $+0.004$ -0.003 | W $+0.020$ -0.036 | Y Dia ± 0.010 | Z Max |
|--------------|------------|----------------------------|-------------------|---------------------|---------------------|---------------|---------------|-------------------------|---------------------|-------------------|-------|
| 10-107210 | 10S | .6250-0.05P-0.1L-DS | .391 | .703 | .562 | .719 | 1.000 | .150 | .281 | .469 | .451 |
| 10-107212 | 12S | .7500-0.1P-0.2L-DS | .391 | .703 | .562 | .812 | 1.094 | .150 | .281 | .594 | .451 |
| 10-107213 | 12 | .7500-0.1P-0.2L-DS | .625 | .891 | .750 | .812 | 1.094 | .150 | .469 | .594 | .700 |
| 10-107214 | 14S | .8750-0.1P-0.2L-DS | .391 | .703 | .562 | .906 | 1.188 | .150 | .281 | .719 | .451 |
| 10-107215 | 14 | .8750-0.1P-0.2L-DS | .625 | .891 | .750 | .906 | 1.188 | .150 | .469 | .719 | .700 |
| 10-107216 | 16S | 1.0000-0.1P-0.2L-DS | .391 | .703 | .562 | .969 | 1.281 | .150 | .281 | .844 | .451 |
| 10-107217 | 16 | 1.0000-0.1P-0.2L-DS | .625 | .891 | .750 | .969 | 1.281 | .150 | .469 | .844 | .700 |
| 10-107218 | 18 | 1.1250-0.1P-0.2L-DS | .625 | .906 | .750 | 1.062 | 1.375 | .177 | .453 | .969 | .686 |
| 10-107220 | 20 | 1.2500-0.1P-0.2L-DS | .625 | .906 | .750 | 1.156 | 1.500 | .177 | .453 | 1.125 | .686 |
| 10-107222 | 22 | 1.3750-0.1P-0.2L-DS | .625 | .906 | .750 | 1.250 | 1.625 | .177 | .453 | 1.250 | .686 |
| 10-107224 | 24 | 1.5000-0.1P-0.2L-DS | .625 | 1.000 | .812 | 1.375 | 1.750 | .177 | .359 | 1.375 | .585 |
| 10-107228 | 28 | 1.7500-0.1P-0.2L-DS | .625 | 1.000 | .812 | 1.562 | 2.000 | .177 | .359 | 1.594 | .591 |
| 10-107232 | 32 | 2.0000-0.1P-0.2L-DS | .625 | 1.063 | .875 | 1.750 | 2.250 | .209 | .296 | 1.844 | .528 |
| 10-107236 | 36 | 2.2500-0.1P-0.2L-DS | .625 | 1.063 | .875 | 1.938 | 2.500 | .209 | .296 | 2.031 | .528 |
| 10-107240 | 40 | 2.5000-0.1P-0.2L-DS | .625 | 1.063 | .875 | 2.188 | 2.750 | .209 | .296 | 2.281 | .528 |
| 10-107244 | 44 | 2.7500-0.1P-0.2L-DS | .625 | 1.063 | .875 | 2.375 | 3.000 | .209 | .546 | 2.562 | .769 |
| 10-107248 | 48 | 3.0000-0.1P-0.2L-DS | .625 | 1.063 | .875 | 2.625 | 3.250 | .209 | .546 | 2.812 | .769 |

*For complete order number see page 4

QWL

10-1073XX

jam nut receptacle (wall mount)



| Shell Size | K Dia +.005 -.000 | G ±.003 | U ±.005 |
|------------|-------------------------|------------|------------|
| 10 | .880 | .518 | .625 |
| 12, 13 | 1.005 | .562 | .688 |
| 14, 15 | 1.130 | .606 | .750 |
| 16, 17 | 1.255 | .699 | .875 |
| 18 | 1.380 | .739 | .938 |
| 20 | 1.505 | .783 | 1.000 |
| 22 | 1.630 | .830 | 1.062 |
| 24 | 1.880 | .919 | 1.188 |
| 28 | 2.130 | 1.007 | 1.312 |
| 32 | 2.380 | 1.096 | 1.438 |
| 36 | 2.630 | 1.183 | 1.562 |
| 40 | 2.880 | 1.292 | 1.703 |

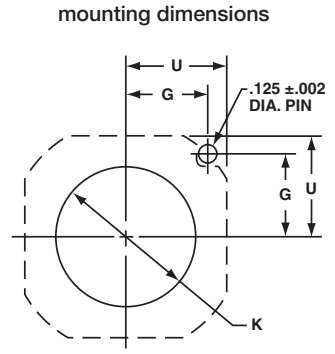

All dimensions for reference only.

| Part Number* | Shell Size | A Thread Class 2A | B ±.010 | E Thread Class 2A | F Hex ±.010 | H Panel Thickness | | M ±.010 | N ±.015 | P ±.010 | S ±.010 | V Thread Class 2A-LH | W ±.010 | Z Max |
|--------------|------------|---------------------|---------|-------------------|-------------|-------------------|------|---------|---------|---------|---------|----------------------|---------|-------|
| | | | | | | Min | Max | | | | | | | |
| 10-107310 | 10S | .6250-0.5-0.1L-DS | .385 | .6875-24UNEF | .875 | .094 | .227 | .844 | .469 | .375 | 1.062 | .500-28UNEF | .344 | .295 |
| 10-107312 | 12S | .7500-0.1P-0.2L-DS | .385 | .875-20UNEF | 1.062 | .094 | .200 | .906 | .469 | .442 | 1.250 | .625-24UNEF | .344 | .232 |
| 10-107313 | 12 | .7500-0.1P-0.2L-DS | .585 | .875-20UNEF | 1.062 | .094 | .188 | 1.094 | .641 | .442 | 1.250 | .625-24UNEF | .516 | .483 |
| 10-107314 | 14S | .8750-0.1P-0.2L-DS | .385 | 1.000-20UNEF | 1.250 | .094 | .200 | .906 | .469 | .486 | 1.376 | .750-20UNEF | .344 | .232 |
| 10-107315 | 14 | .8750-0.1P-0.2L-DS | .585 | 1.000-20UNEF | 1.250 | .094 | .188 | 1.094 | .641 | .486 | 1.376 | .750-20UNEF | .516 | .483 |
| 10-107316 | 16S | 1.0000-0.1P-0.2L-DS | .385 | 1.125-18UNEF | 1.312 | .094 | .200 | .906 | .469 | .530 | 1.500 | .875-20UNEF | .344 | .232 |
| 10-107317 | 16 | 1.0000-0.1P-0.2L-DS | .585 | 1.125-18UNEF | 1.312 | .094 | .188 | 1.094 | .641 | .530 | 1.500 | .875-20UNEF | .516 | .483 |
| 10-107318 | 18 | 1.1250-0.1P-0.2L-DS | .585 | 1.250-18UNEF | 1.500 | .094 | .203 | 1.109 | .704 | .623 | 1.750 | 1.000-20UNEF | .516 | .467 |
| 10-107320 | 20 | 1.2500-0.1P-0.2L-DS | .585 | 1.375-18UNEF | 1.562 | .094 | .203 | 1.109 | .704 | .663 | 1.875 | 1.125-18UNEF | .516 | .467 |
| 10-107322 | 22 | 1.3750-0.1P-0.2L-DS | .585 | 1.500-18UNEF | 1.750 | .094 | .203 | 1.109 | .704 | .707 | 2.000 | 1.250-18UNEF | .516 | .467 |
| 10-107324 | 24 | 1.5000-0.1P-0.2L-DS | .585 | 1.625-18UNEF | 1.875 | .094 | .265 | 1.172 | .704 | .751 | 2.125 | 1.375-18UNEF | .516 | .404 |
| 10-107328 | 28 | 1.7500-0.1P-0.2L-DS | .585 | 1.875-16UNEF | 2.125 | .094 | .265 | 1.172 | .704 | .840 | 2.375 | 1.625-18UNEF | .516 | .404 |
| 10-107332 | 32 | 2.0000-0.1P-0.2L-DS | .585 | 2.125-16UNEF | 2.375 | .094 | .203 | 1.172 | .735 | .928 | 2.625 | 1.875-16UN | .516 | .404 |
| 10-107336 | 36 | 2.2500-0.1P-0.2L-DS | .585 | 2.375-16UN | 2.625 | .094 | .203 | 1.172 | .735 | 1.017 | 2.875 | 2.0625-16UN | .516 | .404 |
| 10-107340 | 40 | 2.5000-0.1P-0.2L-DS | .585 | 2.625-16UN | 2.875 | .094 | .203 | 1.172 | .735 | 1.104 | 3.125 | 2.3125-16UN | .516 | .404 |
| 10-107344 | 44 | 2.7500-0.1P-0.2L-DS | .585 | 2.875-16UN | 3.125 | .094 | .265 | 1.234 | .922 | 1.213 | 3.406 | 2.625-16UN | .703 | .593 |
| 10-107348 | 48 | 3.0000-0.1P-0.2L-DS | .585 | 3.125-16UN | 3.375 | .094 | .265 | 1.234 | .922 | 1.299 | 3.656 | 2.875-16UN | .703 | .593 |

*For complete order number see page 4.

QWL 10-1074XX

thru bulkhead receptacle

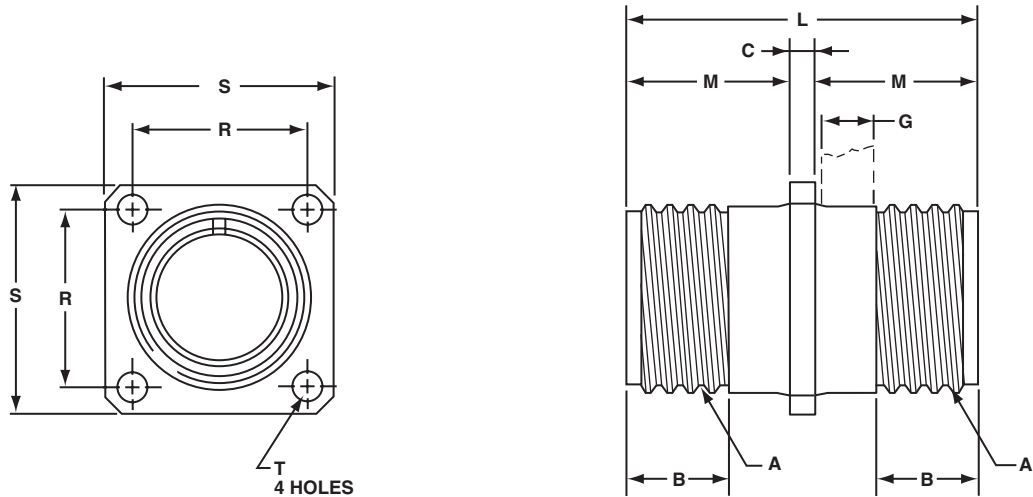

All dimensions for reference only.

| Part Number* | Shell Size | A Thread Class 2A | B Min Full Thread | C Ref | G Max Bulkhead Thickness | L ±.015 | M +.000 - .010 | R ±.005 | S ±.020 | T Dia +.004 - .003 |
|--------------|------------|---------------------|-------------------|-------|--------------------------|---------|----------------|---------|---------|--------------------|
| 10-107410 | 10S | .6250-0.05P-0.1L-DS | .406 | .141 | .266 | 1.563 | .711 | .719 | 1.000 | .120 |
| 10-107412 | 12S | .7500-0.1P-0.2L-DS | .406 | .141 | .266 | 1.563 | .711 | .812 | 1.094 | .120 |
| 10-107413 | 12 | .7500-0.1P-0.2L-DS | .625 | .155 | .312 | 2.125 | .985 | .812 | 1.094 | .120 |
| 10-107414 | 14S | .8750-0.1P-0.2L-DS | .406 | .141 | .266 | 1.563 | .711 | .906 | 1.188 | .120 |
| 10-107415 | 14 | .8750-0.1P-0.2L-DS | .625 | .155 | .312 | 2.125 | .985 | .906 | 1.188 | .120 |
| 10-107416 | 16S | 1.0000-0.1P-0.2L-DS | .406 | .141 | .266 | 1.563 | .711 | .969 | 1.281 | .120 |
| 10-107417 | 16 | 1.0000-0.1P-0.2L-DS | .625 | .155 | .312 | 2.125 | .985 | .969 | 1.281 | .120 |
| 10-107418 | 18 | 1.1250-0.1P-0.2L-DS | .625 | .155 | .312 | 2.125 | .985 | 1.062 | 1.375 | .120 |
| 10-107420 | 20 | 1.2500-0.1P-0.2L-DS | .625 | .155 | .312 | 2.125 | .985 | 1.156 | 1.500 | .120 |
| 10-107422 | 22 | 1.3750-0.1P-0.2L-DS | .625 | .155 | .312 | 2.125 | .985 | 1.250 | 1.625 | .120 |
| 10-107424 | 24 | 1.5000-0.1P-0.2L-DS | .625 | .155 | .312 | 2.125 | .985 | 1.375 | 1.750 | .147 |
| 10-107428 | 28 | 1.7500-0.1P-0.2L-DS | .625 | .155 | .312 | 2.125 | .985 | 1.562 | 2.000 | .147 |
| 10-107432 | 32 | 2.0000-0.1P-0.2L-DS | .625 | .155 | .312 | 2.125 | .985 | 1.750 | 2.250 | .173 |
| 10-107436 | 36 | 2.2500-0.1P-0.2L-DS | .625 | .155 | .312 | 2.125 | .985 | 1.938 | 2.500 | .173 |
| 10-107440 | 40 | 2.5000-0.1P-0.2L-DS | .625 | .155 | .312 | 2.125 | .985 | 2.188 | 2.750 | .173 |
| 10-107444 | 44 | 2.7500-0.1P-0.2L-DS | .625 | .155 | .438 | 2.375 | 1.110 | 2.375 | 3.000 | .209 |

*For complete order number see page 4

QWL 10-1076XX straight plug



All dimensions for reference only.

| Part Number* | Shell Size | A Thread Class 2B | B ±.020 | D Dia +.010 - .000 | G ±.030 | J ±.005 | N ±.010 | Q Dia Max | V Thread (Plated) Class 2A-LH | Z Max |
|--------------|------------|---------------------|---------|--------------------|---------|---------|---------|-----------|-------------------------------|-------|
| 10-107610 | 10S | .6250-0.05P-0.1L-DS | .406 | .735 | .053 | .531 | .563 | .882 | .500-28UNEF | .603 |
| 10-107612 | 12S | .7500-0.1P-0.2L-DS | .406 | .859 | .109 | .531 | .563 | 1.010 | .625-24UNEF | .603 |
| 10-107613 | 12 | .7500-0.1P-0.2L-DS | .578 | .859 | .077 | .719 | .750 | 1.010 | .625-24UNEF | .852 |
| 10-107614 | 14S | .8750-0.1P-0.2L-DS | .406 | .985 | .234 | .531 | .563 | 1.137 | .750-20UNEF | .603 |
| 10-107615 | 14 | .8750-0.1P-0.2L-DS | .578 | .985 | .077 | .719 | .750 | 1.137 | .750-20UNEF | .852 |
| 10-107616 | 16S | 1.0000-0.1P-0.2L-DS | .406 | 1.109 | .234 | .531 | .563 | 1.264 | .875-20UNEF | .603 |
| 10-107617 | 16 | 1.0000-0.1P-0.2L-DS | .578 | 1.109 | .141 | .719 | .750 | 1.264 | .875-20UNEF | .852 |
| 10-107618 | 18 | 1.1250-0.1P-0.2L-DS | .578 | 1.235 | .266 | .719 | .750 | 1.455 | 1.000-20UNEF | .852 |
| 10-107620 | 20 | 1.2500-0.1P-0.2L-DS | .578 | 1.359 | .266 | .719 | .750 | 1.551 | 1.1250-18UNEF | .852 |
| 10-107622 | 22 | 1.3750-0.1P-0.2L-DS | .578 | 1.485 | .266 | .719 | .750 | 1.678 | 1.2500-18UNEF | .852 |
| 10-107624 | 24 | 1.5000-0.1P-0.2L-DS | .594 | 1.609 | .266 | .719 | .812 | 1.806 | 1.375-18UNEF | .852 |
| 10-107628 | 28 | 1.7500-0.1P-0.2L-DS | .594 | 1.859 | .266 | .719 | .812 | 2.060 | 1.625-18UNEF | .852 |
| 10-107632 | 32 | 2.0000-0.1P-0.2L-DS | .594 | 2.109 | .266 | .719 | .875 | 2.315 | 1.875-16UN | .852 |
| 10-107636 | 36 | 2.2500-0.1P-0.2L-DS | .556† | 2.359 | .285** | .719 | .875 | 2.569 | 2.0625-16UNS | .852 |
| 10-107640 | 40 | 2.5000-0.1P-0.2L-DS | .556† | 2.609 | .285** | .719 | .875 | 2.824 | 2.3125-16UNS | .852 |
| 10-107644 | 44 | 2.7500-0.1P-0.2L-DS | .700†† | 2.922 | .141*** | .719 | 1.000 | 3.142 | 2.625-16UN | 1.103 |
| 10-107648 | 48 | 3.0000-0.1P-0.2L-DS | .719 | 3.172 | .141 | .719 | 1.000 | 3.381 | 2.875-16UN | 1.093 |

*For complete order number see page 4

**Applicable Tolerance is ±.033

***Applicable Tolerance is +.030

-.020

†Applicable Tolerance is ±.026

††Applicable Tolerance is +.013

-.023

QWL 10-1077XX flange mount plug



All dimensions for reference only.

| Part Number* | Shell Size | A Thread Class 2B | C ±.005 | J ±.005 | N ±.020 | R ±.005 | S ±.020 | T Thread | Z Max |
|--------------|------------|---------------------|---------|---------|---------|---------|---------|----------|-------|
| 10-107710 | 10S | .6250-0.05P-0.1L-DS | .125 | .531 | .438 | .562 | .781 | 4-40 NC | .602 |
| 10-107712 | 12S | .7500-0.1P-0.2L-DS | .156 | .531 | .438 | .812 | 1.062 | 4-40 NC | .602 |
| 10-107713 | 12 | .7500-0.1P-0.2L-DS | .156 | .719 | .688 | .812 | 1.062 | 4-40 NC | .852 |
| 10-107714 | 14S | .8750-0.1P-0.2L-DS | .156 | .531 | .438 | .812 | 1.062 | 4-40 NC | .602 |
| 10-107715 | 14 | .8750-0.1P-0.2L-DS | .156 | .719 | .688 | .812 | 1.062 | 4-40 NC | .852 |
| 10-107716 | 16S | 1.0000-0.1P-0.2L-DS | .156 | .531 | .438 | 1.000 | 1.312 | 6-32 NC | .602 |
| 10-107717 | 16 | 1.0000-0.1P-0.2L-DS | .156 | .719 | .688 | 1.000 | 1.312 | 6-32 NC | .852 |
| 10-107718 | 18 | 1.1250-0.1P-0.2L-DS | .156 | .719 | .688 | 1.000 | 1.312 | 6-32 NC | .852 |
| 10-107720 | 20 | 1.2500-0.1P-0.2L-DS | .188 | .719 | .688 | 1.250 | 1.625 | 10-32 NF | .852 |
| 10-107722 | 22 | 1.3750-0.1P-0.2L-DS | .188 | .719 | .688 | 1.250 | 1.625 | 10-32 NF | .852 |
| 10-107724 | 24 | 1.5000-0.1P-0.2L-DS | .188 | .719 | .688 | 1.562 | 2.000 | 10-32 NF | .852 |
| 10-107728 | 28 | 1.7500-0.1P-0.2L-DS | .188 | .719 | .688 | 1.562 | 2.000 | 10-32 NF | .852 |
| 10-107732 | 32 | 2.0000-0.1P-0.2L-DS | .250 | .719 | .781 | 1.812 | 2.500 | 10-32 NF | .852 |
| 10-107736 | 36 | 2.2500-0.1P-0.2L-DS | .250 | .719 | .781 | 1.812 | 2.500 | 10-32 NF | .852 |
| 10-107740 | 40 | 2.5000-0.1P-0.2L-DS | .250 | .719 | .781 | 2.250 | 3.031 | 10-32 NF | .852 |
| 10-107744 | 44 | 2.7500-0.1P-0.2L-DS | .250 | .719 | 1.000 | 2.375 | 3.031 | 10-32 NF | .852 |
| 10-107748 | 48 | 3.0000-0.1P-0.2L-DS | .250 | .719 | 1.000 | 2.562 | 3.250 | 10-32 NF | .852 |

*For complete order number see page 4

QWL

10-1079XX

jam nut receptacle (box mount)

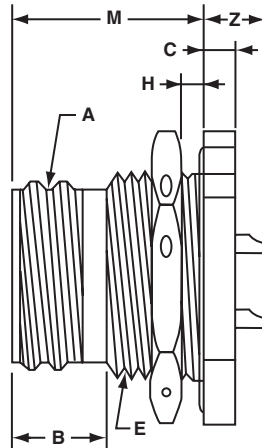
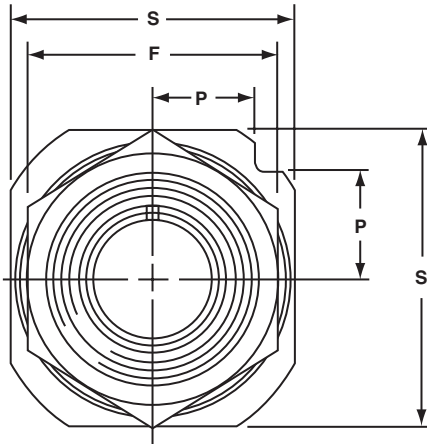

| Shell Size | K Dia +.005 -.000 | G ±.003 | U ±.005 |
|------------|-------------------------|------------|------------|
| 10 | .693 | .451 | .531 |
| 12, 13 | .880 | .518 | .625 |
| 14, 15 | 1.005 | .562 | .688 |
| 16, 17 | 1.130 | .606 | .750 |
| 18 | 1.255 | .699 | .875 |
| 20 | 1.380 | .739 | .938 |
| 22 | 1.505 | .783 | 1.000 |
| 24 | 1.630 | .830 | 1.062 |
| 28 | 1.880 | .919 | 1.188 |
| 32 | 2.130 | 1.007 | 1.312 |
| 36 | 2.380 | 1.096 | 1.438 |
| 40 | 2.630 | 1.183 | 1.562 |
| 44 | 2.880 | 1.292 | 1.703 |
| 48 | 3.130 | 1.378 | 1.828 |

mounting dimensions

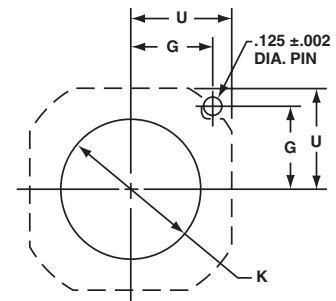

All dimensions for reference only.

| Part Number* | Shell Size | A Thread Class 2A | B ±.010 | C ±.005 | E Thread Class 2A (Plated) | F Hex ±.016 | H Panel Thickness | | M ±.010 | P ±.010 | S ±.010 | Z Max |
|--------------|------------|---------------------|---------|---------|----------------------------|-------------|-------------------|------|---------|---------|---------|-------|
| | | | | | | | Min | Max | | | | |
| 10-107910 | 10S | .6250-0.05P-0.1L-DS | .385 | .125 | .6875-24NEF | .875 | .094 | .227 | .844 | .375 | 1.062 | .295 |
| 10-107912 | 12S | .7500-0.1P-0.2L-DS | .385 | .125 | .875-20UNEF | 1.062 | .094 | .200 | .906 | .442 | 1.250 | .232 |
| 10-107913 | 12 | .7500-0.1P-0.2L-DS | .585 | .125 | .875-20UNEF | 1.062 | .094 | .282 | 1.188 | .442 | 1.250 | .389 |
| 10-107914 | 14S | .8750-0.1P-0.2L-DS | .385 | .125 | 1.000-20UNEF | 1.250 | .094 | .200 | .906 | .486 | 1.376 | .232 |
| 10-107915 | 14 | .8750-0.1P-0.2L-DS | .585 | .125 | 1.000-20UNEF | 1.250 | .094 | .282 | 1.188 | .486 | 1.376 | .389 |
| 10-107916 | 16S | 1.0000-0.1P-0.2L-DS | .385 | .125 | 1.125-18NEF | 1.312 | .094 | .200 | .906 | .530 | 1.500 | .232 |
| 10-107917 | 16 | 1.0000-0.1P-0.2L-DS | .585 | .125 | 1.125-18NEF | 1.312 | .094 | .282 | 1.188 | .530 | 1.500 | .389 |
| 10-107918 | 18 | 1.1250-0.1P-0.2L-DS | .585 | .188 | 1.250-18NEF | 1.500 | .094 | .250 | 1.156 | .623 | 1.750 | .420 |
| 10-107920 | 20 | 1.2500-0.1P-0.2L-DS | .585 | .188 | 1.375-18NEF | 1.562 | .094 | .250 | 1.156 | .663 | 1.875 | .420 |
| 10-107922 | 22 | 1.3750-0.1P-0.2L-DS | .585 | .188 | 1.500-18NEF | 1.750 | .094 | .250 | 1.156 | .707 | 2.000 | .420 |
| 10-107924 | 24 | 1.5000-0.1P-0.2L-DS | .585 | .188 | 1.625-18NEF | 1.875 | .094 | .312 | 1.219 | .751 | 2.125 | .357 |
| 10-107928 | 28 | 1.7500-0.1P-0.2L-DS | .585 | .188 | 1.875-16UN | 2.125 | .094 | .312 | 1.219 | .840 | 2.375 | .357 |
| 10-107932 | 32 | 2.0000-0.1P-0.2L-DS | .585 | .219 | 2.125-16UN | 2.375 | .094 | .282 | 1.250 | .928 | 2.625 | .326 |
| 10-107936 | 36 | 2.2500-0.1P-0.2L-DS | .585 | .219 | 2.375-16UN | 2.625 | .094 | .282 | 1.250 | 1.017 | 2.875 | .326 |
| 10-107940 | 40 | 2.5000-0.1P-0.2L-DS | .585 | .219 | 2.625-16UN | 2.875 | .094 | .282 | 1.250 | 1.104 | 3.125 | .326 |
| 10-107944 | 44 | 2.7500-0.1P-0.2L-DS | .585 | .219 | 2.875-16UN | 3.125 | .094 | .422 | 1.390 | 1.213 | 3.406 | .436 |
| 10-107948 | 48 | 3.0000-0.1P-0.2L-DS | .585 | .219 | 3.125-16UN | 3.375 | .094 | .422 | 1.390 | 1.299 | 3.656 | .436 |

*For complete order number see page 4.

QWL

insert arrangements - selection guide

| Insert Arrangement | Service Rating | Total Contacts | Contact Size | | | | |
|--------------------|----------------|----------------|--------------|---|---|----|----|
| | | | 0 | 4 | 8 | 12 | 16 |
| 10S-2 | A | 1 | | | | | 1 |
| 12S-3 | A | 2 | | | | | 2 |
| 12S-4 | D | 1 | | | | | 1 |
| 12S-5 | D | 1 | | | | 1 | |
| 14S-1 | A | 3 | | | | | 3 |
| 14S-2 | Inst. | 4 | | | | | 4 |
| 14S-4 | D | 1 | | | | | 1 |
| 14S-5 | Inst. | 5 | | | | | 5 |
| 14S-6 | Inst. | 6 | | | | | 6 |
| 14S-7 | A | 3 | | | | | 3 |
| 14S-9 | A | 2 | | | | | 2 |
| 14S-10 | Inst. | 4 | | | | | 4 |
| 14S-12 | A | 3 | | | | | 3 |
| 14-3 | A | 1 | | | 1 | | |
| 16S-1 | A | 7 | | | | | 7 |
| 16S-3 | B | 1 | | | | | 1 |
| 16S-4 | D | 2 | | | | | 2 |
| 16S-5 | A | 3 | | | | | 3 |
| 16S-6 | A | 3 | | | | | 3 |
| 16S-8 | A | 5 | | | | | 5 |
| 16-2 | E | 1 | | | | 1 | |
| 16-7 | A | 3 | | | 1 | | 2 |
| 16-9 | A | 4 | | | | 2 | 2 |
| 16-10 | A | 3 | | | | 3 | |
| 16-11 | A | 2 | | | | 2 | |
| 16-12 | A | 1 | | 1 | | | |
| 16-13 | A | 2 | | | | 2 | |
| 18-1 | A/Inst. | 10 | | | | | 10 |
| 18-3 | D | 2 | | | | 2 | |
| 18-4 | D | 4 | | | | | 4 |
| 18-5 | D | 3 | | | | 2 | 1 |
| 18-6 | D | 1 | | 1 | | | |
| 18-7 | B | 1 | | | 1 | | |
| 18-8 | A | 8 | | | | 1 | 7 |
| 18-9 | Inst. | 7 | | | | 2 | 5 |
| 18-10 | A | 4 | | | | 4 | |
| 18-11 | A | 5 | | | | 5 | |
| 18-12 | A | 6 | | | | | 6 |
| 18-13 | A | 4 | | | 1 | 3 | |
| 18-14 | A | 2 | | 1 | | | 1 |
| 18-15 | A | 4 | | | | 4 | |
| 18-16 | C | 1 | | | | 1 | |
| 18-17 | Inst. | 7 | | | | 2 | 5 |
| 18-19 | A | 10 | | | | | 10 |
| 18-20 | A | 5 | | | | | 5 |
| 18-22 | D | 3 | | | | | 3 |
| 18-24 | A/Inst. | 10 | | | | | 10 |
| 18-29 | A | 5 | | | | | 5 |
| 18-30 | A | 5 | | | | | 5 |
| 18-31 | A | 5 | | | | | 5 |

| Insert Arrangement | Service Rating | Total Contacts | Contact Size | | | | |
|--------------------|----------------|----------------|--------------|---|---|----|----|
| | | | 0 | 4 | 8 | 12 | 16 |
| 20-2 | D | 1 | 1 | | | | |
| 20-3 | D | 3 | | | | 3 | |
| 20-4 | D | 4 | | | | 4 | |
| 20-6 | D | 3 | | | | | 3 |
| 20-7 | D/A | 8 | | | | | 8 |
| 20-8 | Inst. | 6 | | | 2 | | 4 |
| 20-9 | D/A | 8 | | | | 1 | 7 |
| 20-11 | Inst. | 13 | | | | | 13 |
| 20-12 | A | 2 | | 1 | | | 1 |
| 20-14 | A | 5 | | | 2 | 3 | |
| 20-15 | A | 7 | | | | 7 | |
| 20-16 | A | 9 | | | | 2 | 7 |
| 20-17 | A | 6 | | | | 5 | 1 |
| 20-18 | A | 9 | | | | 3 | 6 |
| 20-19 | A | 3 | | | 3 | | |
| 20-20 | A | 4 | | 1 | | 3 | |
| 20-21 | A | 9 | | | | 1 | 8 |
| 20-22 | A | 6 | | | 3 | | 3 |
| 20-23 | A | 2 | | | 2 | | |
| 20-24 | A | 4 | | | 2 | | 2 |
| 20-25 | Inst. | 13 | | | | | 13 |
| 20-27 | A | 14 | | | | | 14 |
| 20-29 | A | 17 | | | | | 17 |
| 20-30 | Inst. | 13 | | | | | 13 |
| 20-33 | A | 11 | | | | | 11 |
| 22-1 | D | 2 | | | 2 | | |
| 22-2 | D | 3 | | | 3 | | |
| 22-4 | A | 4 | | | 2 | 2 | |
| 22-5 | D | 6 | | | | 2 | 4 |
| 22-6 | D | 3 | | | 2 | | 1 |
| 22-7 | E | 1 | 1 | | | | |
| 22-8 | E | 2 | | | | 2 | |
| 22-9 | E | 3 | | | | 3 | |
| 22-10 | E | 4 | | | | | 4 |
| 22-11 | B | 2 | | | | | 2 |
| 22-12 | D | 5 | | | 2 | | 3 |
| 22-13 | D/A | 5 | | | | 4 | 1 |
| 22-14 | A | 19 | | | | | 19 |
| 22-15 | E/A | 6 | | | | 5 | 1 |
| 22-16 | A | 9 | | | | 3 | 6 |
| 22-17 | D/A | 9 | | | | 1 | 8 |
| 22-18 | D/A | 8 | | | | | 8 |
| 22-19 | A | 14 | | | | | 14 |
| 22-20 | A | 9 | | | | | 9 |
| 22-21 | A | 3 | 1 | | | | 2 |
| 22-22 | A | 4 | | | 4 | | |
| 22-23 | D/A | 8 | | | | 8 | |
| 22-24 | D/A | 6 | | | | 2 | 4 |
| 22-27 | D/A | 9 | | | 1 | | 8 |
| 22-28 | A | 7 | | | | 7 | |

QWL

insert arrangements, cont.

| Insert Arrangement | Service Rating | Total Contacts | Contact Size | | | | |
|--------------------|----------------|----------------|--------------|---|---|----|----|
| | | | 0 | 4 | 8 | 12 | 16 |
| 22-33 | D/A | 7 | | | | | 7 |
| 22-34 | D | 5 | | | | 3 | 2 |
| 22-36 | D/A | 8 | | | | 8 | |
| 24-2 | D | 7 | | | | 7 | |
| 24-3 | D | 7 | | | | 2 | 5 |
| 24-5 | A | 16 | | | | | 16 |
| 24-6 | D/A | 8 | | | | 8 | |
| 24-7 | A | 16 | | | | 2 | 14 |
| 24-9 | A | 2 | | 2 | | | |
| 24-10 | A | 7 | | | 7 | | |
| 24-11 | A | 9 | | | 3 | 6 | |
| 24-12 | A | 5 | | 2 | | 3 | |
| 24-16 | D/A | 7 | | | 1 | 3 | 3 |
| 24-17 | D | 5 | | | | 2 | 3 |
| 24-20 | D | 11 | | | | 2 | 9 |
| 24-21 | D | 10 | | | 1 | | 9 |
| 24-22 | D | 4 | | | 4 | | |
| 24-27 | E | 7 | | | | | 7 |
| 24-28 | Inst. | 24 | | | | | 24 |
| 28-1 | D/A | 9 | | | 3 | 6 | |
| 28-2 | D | 14 | | | | 2 | 12 |
| 28-3 | E | 3 | | | 3 | | |
| 28-4 | E/D | 9 | | | | 2 | 7 |
| 28-5 | D | 5 | | 2 | | 1 | 2 |
| 28-6 | D | 3 | | 3 | | | |
| 28-7 | D | 2 | | 2 | | | |
| 28-8 | E/D/A | 12 | | | | 2 | 10 |
| 28-9 | D | 12 | | | | 6 | 6 |
| 28-10 | D/A | 7 | | 2 | 2 | 3 | |
| 28-11 | A | 22 | | | | 4 | 18 |
| 28-12 | A | 26 | | | | | 26 |
| 28-13 | A | 26 | | | | | 26 |
| 28-15 | A | 35 | | | | | 35 |
| 28-16 | A | 20 | | | | | 20 |
| 28-17 | B/D/A | 15 | | | | | 15 |
| 28-18 | C/D/A/Inst. | 12 | | | | | 12 |
| 28-19 | B/D/A | 10 | | | | 4 | 6 |
| 28-20 | A | 14 | | | | 10 | 4 |
| 28-21 | A | 37 | | | | | 37 |
| 28-22 | D | 6 | | 3 | | | 3 |

| Insert Arrangement | Service Rating | Total Contacts | Contact Size | | | | |
|--------------------|----------------|----------------|--------------|---|---|----|----|
| | | | 0 | 4 | 8 | 12 | 16 |
| 32-1 | E/D | 5 | 2 | | | 3 | |
| 32-2 | E | 5 | | 3 | | | 2 |
| 32-3 | D | 9 | 1 | 2 | | 2 | 4 |
| 32-4 | A/D | 14 | | | | 2 | 12 |
| 32-5 | D | 2 | 2 | | | | |
| 32-6 | A | 23 | | 2 | 3 | 2 | 16 |
| 32-7 | Inst./A | 35 | | | | 7 | 28 |
| 32-8 | A | 30 | | | | 6 | 24 |
| 32-9 | D | 14 | | 2 | | | 12 |
| 32-10 | E/B/D/A | 7 | | 2 | 2 | | 3 |
| 32-12 | A/D | 15 | | | | 5 | 10 |
| 32-13 | D | 23 | | | | 5 | 18 |
| 32-15 | D | 8 | 2 | | | 6 | |
| 32-16 | A | 23 | | 2 | 3 | 2 | 16 |
| 32-17 | D | 4 | | 4 | | | |
| 32-22 | A | 54 | | | | | 54 |
| 36-1 | D | 22 | | | | 4 | 18 |
| 36-3 | D | 6 | 3 | | | 3 | |
| 36-4 | D/A | 3 | 3 | | | | |
| 36-5 | A | 4 | 4 | | | | |
| 36-6 | A | 6 | 2 | 4 | | | |
| 36-7 | A | 47 | | | | 7 | 40 |
| 36-8 | A | 47 | | | | 1 | 46 |
| 36-9 | A | 31 | | 1 | 2 | 14 | 14 |
| 36-10 | A | 48 | | | | | 48 |
| 36-11 | A | 48 | | | | | 48 |
| 36-12 | A | 48 | | | | | 48 |
| 36-13 | E/A | 17 | | | | 2 | 15 |
| 36-14 | D | 16 | | | 5 | 5 | 6 |
| 36-15 | D/A | 35 | | | | | 35 |
| 36-16 | A | 47 | | | | 7 | 40 |
| 36-17 | A | 47 | | | | 7 | 40 |
| 36-18 | A | 31 | | 1 | 2 | 14 | 14 |
| 36-20 | A | 34 | | | 2 | 2 | 30 |
| 36-52 | A | 52 | | | | | 52 |
| 40-1 | D | 30 | | | | 6 | 24 |
| 40-9 | A | 47 | | | 1 | 22 | 24 |
| 40-56 | A | 85 | | | | | 85 |
| 48-62 | D | 85 | | | | | 85 |

QWL alternate positioning

To avoid cross-plugging problems in applications requiring the use of more than one connector of the same size and arrangement, alternate rotations are available as indicated in the accompanying charts.

As shown in the diagram below, the front face of the pin insert is rotated within the shell in a clockwise direction from the normal shell key. The socket insert would be rotated counter-clockwise the same number of degrees in respect to the normal shell key.

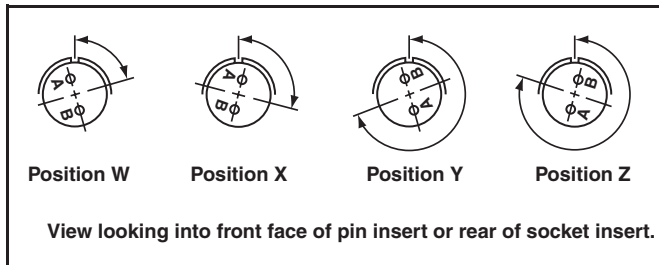

The following insert arrangements have the same alternate insert rotations for W, X, Y and Z, which are:

| Degrees | | | |
|---------|-----|-----|-----|
| W | X | Y | Z |
| 80 | 110 | 250 | 280 |

| | | | | | |
|-------|-------|-------|-------|-------|-------|
| 16-7 | 20-22 | 22-29 | 24-17 | 28-16 | 32-13 |
| 18-5 | 22-6 | 22-33 | 24-20 | 28-17 | 32-22 |
| 18-9 | 22-12 | 22-34 | 24-21 | 28-19 | 32-AF |
| 18-13 | 22-14 | 24-1 | 24-28 | 28-20 | 36-1 |
| 18-14 | 22-15 | 24-3 | 28-1 | 28-21 | 36-7 |
| 20-7 | 22-16 | 24-4 | 28-4 | 32-1 | 36-8 |
| 20-8 | 22-17 | 24-5 | 28-8 | 32-3 | 36-13 |
| 20-9 | 22-18 | 24-6 | 28-9 | 32-4 | 40-AR |
| 20-12 | 22-19 | 24-7 | 28-10 | 32-6 | 40-AS |
| 20-14 | 22-21 | 24-12 | 28-11 | 32-9 | 40-AT |
| 20-16 | 22-24 | 24-14 | 28-14 | 32-10 | 40-AU |
| 20-20 | 22-25 | 24-16 | 28-15 | 32-12 | |

| Insert Arrangement | Degrees | | | |
|--------------------|---------|-----|-----|-----|
| | W | X | Y | Z |
| 10SL-4 | 63 | - | - | - |
| 12S-3 | 70 | 145 | 215 | 290 |
| 14S-2 | - | 120 | 240 | - |
| 14S-5 | - | 110 | - | - |
| 14S-7 | 90 | 180 | 270 | - |
| 14S-9 | 70 | 145 | 215 | 290 |
| 16-9 | 35 | 110 | 250 | 325 |
| 16-10 | 90 | 180 | 270 | - |
| 16-11 | 35 | 110 | 250 | 325 |
| 16-13 | 35 | 110 | 250 | 325 |
| 16S-1 | 80 | - | - | 280 |
| 16S-4 | 35 | 110 | 250 | 325 |
| 16S-5 | 70 | 145 | 215 | 290 |
| 16S-6 | 90 | 180 | 270 | - |
| 16S-8 | - | 170 | 265 | - |
| 18-1 | 70 | 145 | 215 | 290 |
| 18-3 | 35 | 110 | 250 | 325 |
| 18-4 | 35 | 110 | 250 | 325 |
| 18-8 | 70 | - | - | 290 |
| 18-10 | - | 120 | 240 | - |
| 18-11 | - | 170 | 265 | - |
| 18-12 | 80 | - | - | 280 |
| 18-15 | - | 120 | 240 | - |
| 18-20 | 90 | 180 | 270 | - |
| 18-22 | 70 | 145 | 215 | 290 |
| 18-29 | 90 | 180 | 270 | - |
| 20-3 | 70 | 145 | 215 | 290 |
| 20-4 | 45 | 110 | 250 | - |
| 20-5 | 35 | 110 | 250 | 325 |
| 20-6 | 70 | 145 | 215 | 290 |
| 20-15 | 80 | - | - | 280 |
| 20-17 | 90 | 180 | 270 | - |

| Insert Arrangement | Degrees | | | |
|--------------------|---------|-----|-----|-----|
| | W | X | Y | Z |
| 20-18 | 35 | 110 | 250 | 325 |
| 20-19 | 90 | 180 | 270 | - |
| 20-21 | 35 | 110 | 250 | 325 |
| 20-23 | 35 | 110 | 250 | 325 |
| 20-24 | 35 | 110 | 250 | 325 |
| 20-27 | 35 | 110 | 250 | 325 |
| 20-29 | 80 | - | - | 280 |
| 22-1 | 35 | 110 | 250 | 325 |
| 22-2 | 70 | 145 | 215 | 290 |
| 22-4 | 35 | 110 | 250 | 325 |
| 22-5 | 35 | 110 | 250 | 325 |
| 22-8 | 35 | 110 | 250 | 325 |
| 22-9 | 70 | 145 | 215 | 290 |
| 22-10 | 35 | 110 | 250 | 325 |
| 22-11 | 35 | 110 | 250 | 325 |
| 22-13 | 35 | 110 | 250 | 325 |
| 22-20 | 35 | 110 | 250 | 325 |
| 22-22 | - | 110 | 250 | - |
| 22-23 | 35 | - | 250 | - |
| 22-27 | 80 | - | 250 | 280 |
| 22-28 | 80 | - | - | 280 |
| 22-63 | 20 | - | - | - |
| 24-2 | 80 | - | - | 280 |
| 24-9 | 35 | 110 | 250 | 325 |
| 24-10 | 80 | - | - | 280 |
| 24-11 | 35 | 110 | 250 | 325 |
| 24-22 | 45 | 110 | 250 | - |
| 24-27 | 80 | - | - | 280 |
| 28-2 | 35 | 110 | 250 | 325 |
| 28-3 | 70 | 145 | 215 | 290 |
| 28-5 | 35 | 110 | 250 | 325 |
| 28-6 | 70 | 145 | 215 | 290 |

| Insert Arrangement | Degrees | | | |
|--------------------|---------|-----|-----|-----|
| | W | X | Y | Z |
| 28-7 | 35 | 110 | 250 | 325 |
| 28-12 | 90 | 180 | 270 | - |
| 28-18 | 70 | 145 | 215 | 290 |
| 28-22 | 70 | 145 | 215 | 290 |
| 28-AY | 45 | 110 | 250 | - |
| 32-2 | 70 | 145 | 215 | 290 |
| 32-5 | 35 | 110 | 250 | 325 |
| 32-7 | 80 | 125 | 235 | 280 |
| 32-8 | 80 | 125 | 235 | 280 |
| 32-15 | 35 | 110 | 250 | 280 |
| 32-17 | 45 | 110 | 250 | - |
| 32-25 | 60 | 120 | - | - |
| 32-48 | 80 | - | - | - |
| 32-64 | 80 | 100 | 110 | 250 |
| 32-68 | 30 | - | - | - |
| 32-82 | 30 | - | - | - |
| 36-3 | 70 | 145 | 215 | 290 |
| 36-4 | 70 | 145 | 215 | 290 |
| 36-5 | - | 120 | 240 | - |
| 36-6 | 35 | 110 | 250 | 325 |
| 36-9 | 80 | 125 | 235 | 280 |
| 36-10 | 80 | 125 | 235 | 280 |
| 36-14 | 90 | 180 | 270 | - |
| 36-15 | 60 | 125 | 245 | 305 |
| 36-AF | 65 | - | - | - |
| 40-1 | 65 | 130 | 235 | 300 |
| 40-5 | 33 | - | - | 270 |
| 40-9 | 65 | 125 | 225 | 310 |
| 40-10 | 65 | 125 | 225 | 310 |
| 40-35 | 70 | 130 | 230 | 290 |
| 40-AD | 45 | - | - | - |
| 40-AG | 37 | 74 | 285 | 322 |
| 40-AP | 35 | 110 | 250 | 325 |
| 40-AV | 90 | 180 | 270 | - |

QWL

contact arrangements

front face of pin insert or rear face of socket insert illustrated

| | | | | | | |
|---------------------------|--------------|--------------|--------------|-------------|--------------|--------------|
| | | | | | | |
| Insert Arrangement | 10S-2 | 12S-3 | 12S-4 | 12-5 | 14S-1 | 14S-2 |
| Service Rating | A | A | A | D | A | Inst. |
| Number of Contacts | 1 | 2 | 1 | 1 | 3 | 4 |
| Contact Size | 16 | 16 | 16 | 12 | 16 | 16 |

| | | | | | | |
|---------------------------|--------------|--------------|--------------|--------------|--------------|---------------|
| | | | | | | |
| Insert Arrangement | 14S-4 | 14S-5 | 14S-6 | 14S-7 | 14S-9 | 14S-10 |
| Service Rating | D | Inst. | Inst. | A | A | Inst. |
| Number of Contacts | 1 | 5 | 6 | 3 | 2 | 4 |
| Contact Size | 16 | 16 | 16 | 16 | 16 | 16 |

| | | | | | | |
|---------------------------|---------------|-------------|--------------|--------------|--------------|--------------|
| | | | | | | |
| Insert Arrangement | 14S-12 | 14-3 | 16S-1 | 16S-3 | 16S-4 | 16S-5 |
| Service Rating | A | A | A | B | D | A |
| Number of Contacts | 3 | 1 | 7 | 1 | 2 | 3 |
| Contact Size | 16 | 8 | 16 | 16 | 16 | 16 |

| | | | | | |
|---------------------------|--------------|--------------|-------------|-------------|--------------|
| | | | | | |
| Insert Arrangement | 16S-6 | 16S-8 | 16-2 | 16-7 | 16-9 |
| Service Rating | A | A | E | A | A |
| Number of Contacts | 3 | 5 | 1 | 1 2 | 2 2 |
| Contact Size | 16 | 16 | 12 | 8 16 | 12 16 |



QWL contact arrangements

front face of pin insert or rear face of socket insert illustrated

| | | | | | | |
|---------------------------|--------------|--------------|--------------|--------------|-------------------------------------|-------------------------------------|
| | | | | | | |
| Insert Arrangement | 16-10 | 16-11 | 16-12 | 16-13 | 18-1 | 18-3 |
| Service Rating | A | A | A | A | B, C, F, G = A; Bal. = Inst. | D |
| Number of Contacts | 3 | 2 | 1 | 2* | 10 | 2 |
| Contact Size | 12 | 12 | 4 | 12 | 16 | 12 |
| | | | | | | |
| Insert Arrangement | 18-4 | 18-5 | 18-6 | 18-7 | 18-8 | 18-9 |
| Service Rating | D | D | D | B | A | Inst. |
| Number of Contacts | 4 | 2 1 | 1 | 1 | 1 7 | 2 5 |
| Contact Size | 16 | 12 16 | 4 | 8 | 12 16 | 12 16 |
| | | | | | | |
| Insert Arrangement | 18-10 | 18-11 | 18-12 | 18-13 | 18-14 | 18-15 |
| Service Rating | A | A | A | A | A | A |
| Number of Contacts | 4 | 5 | 6 | 1 3 | 1 1 | 4** |
| Contact Size | 12 | 12 | 16 | 8 12 | 4 16 | 12 |
| | | | | | | |
| Insert Arrangement | 18-16 | 18-17 | 18-19 | 18-20 | 18-22 | 18-24 |
| Service Rating | C | Inst. | A | A | D | B, C, F, G = A; Bal. = Inst. |
| Number of Contacts | 1 | 2 5 | 10 | 5 | 3 | 10 |
| Contact Size | 12 | 12 16 | 16 | 16 | 16 | 16 |

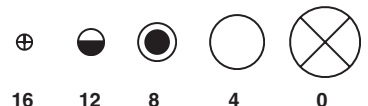

* A = Iron; B = Constantan
 ** A, C = Iron; B, D = Constantan

QWL contact arrangements

front face of pin insert or rear face of socket insert illustrated

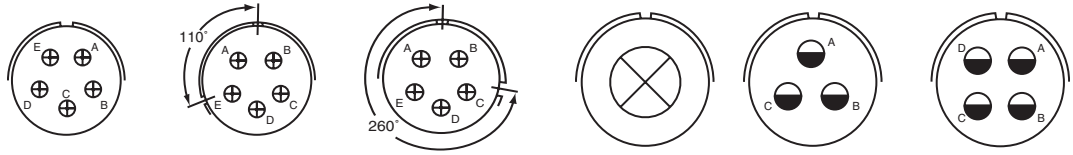

| | | | | | | |
|--------------------|-------|-------|-------|------|------|------|
| Insert Arrangement | 18-29 | 18-30 | 18-31 | 20-2 | 20-3 | 20-4 |
| Service Rating | A | A | A | D | D | D |
| Number of Contacts | 5 | 5 | 5 | 1 | 3 | 4 |
| Contact Size | 16 | 16 | 16 | 0 | 12 | 12 |

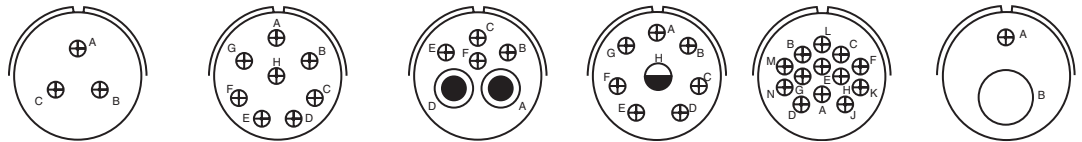

| | | | | | | |
|--------------------|------|--------------------------------|-------|-----------------|-------|-------|
| Insert Arrangement | 20-6 | 20-7 | 20-8 | 20-9 | 20-11 | 20-12 |
| Service Rating | D | A, B, H, G = D; C, D, E, F = A | Inst. | H = D; Bal. = A | Inst. | A |
| Number of Contacts | 3 | 8 | 2 4 | 1 7 | 13 | 1 1 |
| Contact Size | 16 | 16 | 8 16 | 12 16 | 16 | 4 16 |

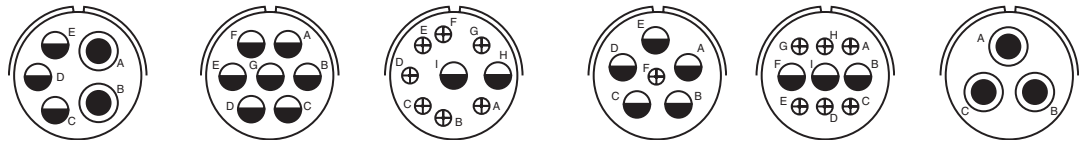

| | | | | | | |
|--------------------|-------|-------|-------|-------|-------|-------|
| Insert Arrangement | 20-14 | 20-15 | 20-16 | 20-17 | 20-18 | 20-19 |
| Service Rating | A | A | A | A | A | A |
| Number of Contacts | 2 3 | 7 | 2 7 | 5 1 | 3 6 | 3 |
| Contact Size | 8 12 | 12 | 12 16 | 12 16 | 12 16 | 8 |



CONTACT LEGEND 16 12 8 4 0

QWL contact arrangements

front face of pin insert or rear face of socket insert illustrated

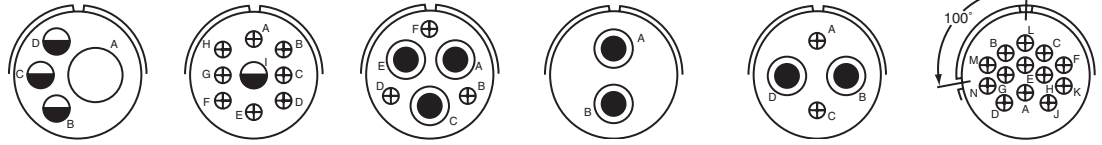

| | | | | | | |
|--------------------|-------|-------|-------|-------|-------|-------|
| Insert Arrangement | 20-20 | 20-21 | 20-22 | 20-23 | 20-24 | 20-25 |
| Service Rating | A | A | A | A | A | Inst. |
| Number of Contacts | 1 3 | 1 8 | 3 3 | 2 | 2 2 | 13 |
| Contact Size | 4 12 | 12 16 | 8 16 | 8 | 8 16 | 16 |

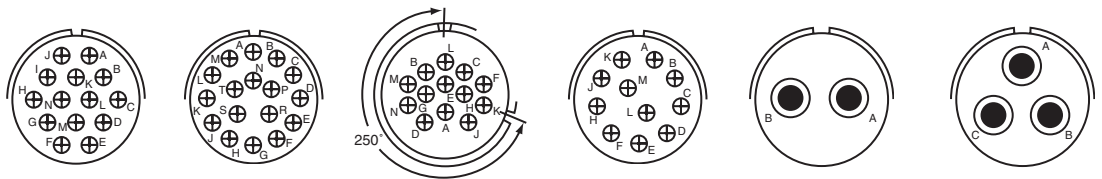

| | | | | | | |
|--------------------|-------|-------|-------|-------|------|------|
| Insert Arrangement | 20-27 | 20-29 | 20-30 | 20-33 | 22-1 | 22-2 |
| Service Rating | A | A | Inst. | A | D | D |
| Number of Contacts | 14 | 17 | 13 | 11 | 2 | 3 |
| Contact Size | 16 | 16 | 16 | 16 | 8 | 8 |

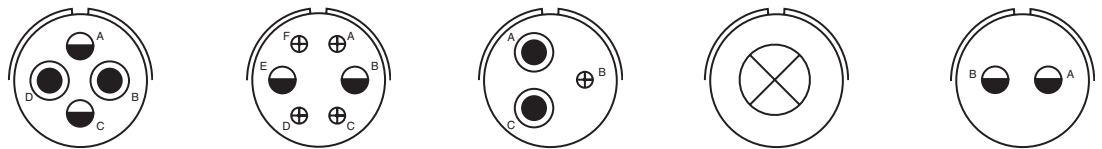

| | | | | | |
|--------------------|------|-------|------|------|------|
| Insert Arrangement | 22-4 | 22-5 | 22-6 | 22-7 | 22-8 |
| Service Rating | A | D | D | E | E |
| Number of Contacts | 2 2 | 2 4 | 2 1 | 1 | 2 |
| Contact Size | 8 12 | 12 16 | 8 16 | 0 | 12 |

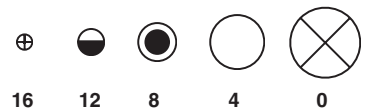

CONTACT LEGEND

16 12 8 4 0

QWL contact arrangements

front face of pin insert or rear face of socket insert illustrated

| | | | | | |
|---------------------------|-------------|--------------|--------------|--------------|------------------------------|
| | | | | | |
| Insert Arrangement | 22-9 | 22-10 | 22-11 | 22-12 | 22-13 |
| Service Rating | E | E | B | D | E = D; A, B, C, D = A |
| Number of Contacts | 3 | 4 | 2 | 2 3 | 4 1 |
| Contact Size | 12 | 16 | 16 | 8 16 | 12 16 |

| | | | | | |
|---------------------------|--------------|---------------------------------|--------------|------------------------|---------------------------------------|
| | | | | | |
| Insert Arrangement | 22-14 | 22-15 | 22-16 | 22-17 | 22-18 |
| Service Rating | A | D = E; A, B, C, E, F = A | A | A = D; Bal. = A | A, B, F, G, H = D; C, D, E = A |
| Number of Contacts | 19 | 5 1 | 3 6 | 1 8 | 8 |
| Contact Size | 16 | 12 16 | 12 16 | 12 16 | 16 |

| | | | | | |
|---------------------------|--------------|--------------|--------------|--------------|------------------------|
| | | | | | |
| Insert Arrangement | 22-19 | 22-20 | 22-21 | 22-22 | 22-23 |
| Service Rating | A | A | A | A | H = D; Bal. = A |
| Number of Contacts | 14 | 9 | 1 2 | 4 | 8 |
| Contact Size | 16 | 16 | 0 16 | 8 | 12 |

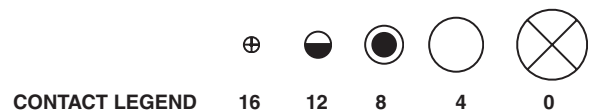

QWL contact arrangements

front face of pin insert or rear face of socket insert illustrated

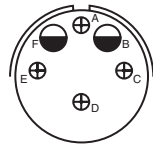

22-24
Service Rating C, D, E = D; A, B, F = A
Number of Contacts 2 4
Contact Size 12 16

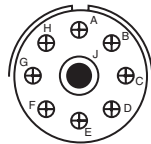

22-27
Service Rating J = D; Bal. = A
Number of Contacts 1 8
Contact Size 8 16

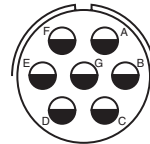

22-28
Service Rating A
Number of Contacts 7
Contact Size 12

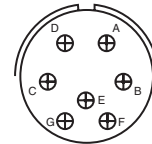

22-33
Service Rating A, B, C, D = D; E, F, G = A
Number of Contacts 7
Contact Size 16

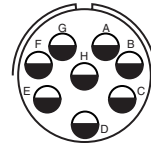

22-36
Service Rating H = D; Bal. = A*
Number of Contacts 8
Contact Size 12

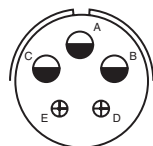

24-34
Service Rating D
Number of Contacts 3 2
Contact Size 12 16

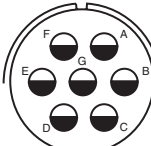

24-2
Service Rating D
Number of Contacts 7
Contact Size 12

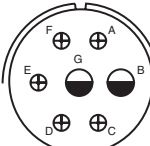

24-3
Service Rating D
Number of Contacts 2 5
Contact Size 12 16

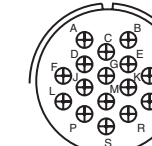

24-5
Service Rating A
Number of Contacts 16
Contact Size 16

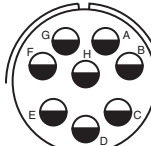

24-6
Service Rating A, G, H = D; Bal. = A
Number of Contacts 8
Contact Size 12

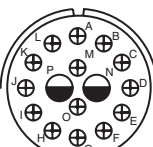

24-7
Service Rating A
Number of Contacts 2 14
Contact Size 12 16

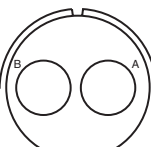

24-9
Service Rating A
Number of Contacts 2
Contact Size 4

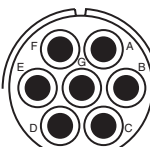

24-10
Service Rating A
Number of Contacts 7
Contact Size 8

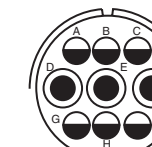

24-11
Service Rating A
Number of Contacts 3 6
Contact Size 8 12

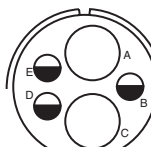

24-12
Service Rating A
Number of Contacts 2 3
Contact Size 4 12

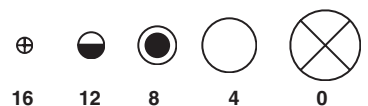

CONTACT LEGEND

16 12 8 4 0

* A, C, E, G = Iron
 B, D, F, H = Constantan

QWL

contact arrangements

front face of pin insert or rear face of socket insert illustrated

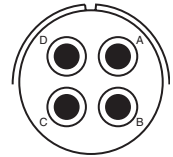
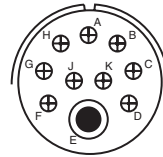
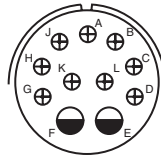
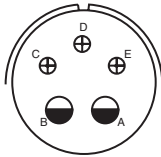

| | | | |
|--------------------|------------------------------|----|----|
| Insert Arrangement | 24-16 | | |
| Service Rating | A, B, F, G = D; C, D, E, = A | | |
| Number of Contacts | 1 | 3 | 3 |
| Contact Size | 8 | 12 | 16 |

| | | |
|--------------------|-------|----|
| Insert Arrangement | 24-17 | |
| Service Rating | D | |
| Number of Contacts | 2 | 3 |
| Contact Size | 12 | 16 |

| | | | |
|--------------------|-------|----|--|
| Insert Arrangement | 24-20 | | |
| Service Rating | D | | |
| Number of Contacts | 2 | 9 | |
| Contact Size | 12 | 16 | |

| | | | |
|--------------------|-------|----|--|
| Insert Arrangement | 24-21 | | |
| Service Rating | D | | |
| Number of Contacts | 1 | 9 | |
| Contact Size | 8 | 16 | |

| | | | |
|--------------------|-------|--|--|
| Insert Arrangement | 24-22 | | |
| Service Rating | D | | |
| Number of Contacts | 4 | | |
| Contact Size | 8 | | |

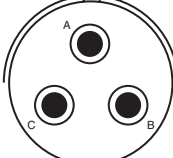
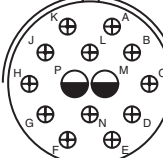
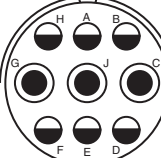
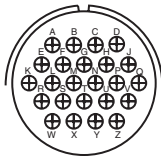
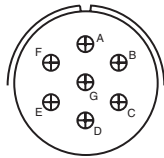

| | | |
|--------------------|-------|--|
| Insert Arrangement | 24-27 | |
| Service Rating | E | |
| Number of Contacts | 7 | |
| Contact Size | 16 | |

| | | | |
|--------------------|-------|--|--|
| Insert Arrangement | 24-28 | | |
| Service Rating | Inst. | | |
| Number of Contacts | 24 | | |
| Contact Size | 16 | | |

| | | | |
|--------------------|-----------------------|----|--|
| Insert Arrangement | 28-1 | | |
| Service Rating | A, J, E = D; Bal. = A | | |
| Number of Contacts | 3 | 6 | |
| Contact Size | 8 | 12 | |

| | | | |
|--------------------|------|----|--|
| Insert Arrangement | 28-2 | | |
| Service Rating | D | | |
| Number of Contacts | 2 | 12 | |
| Contact Size | 12 | 16 | |

| | | | |
|--------------------|------|--|--|
| Insert Arrangement | 28-3 | | |
| Service Rating | E | | |
| Number of Contacts | 3 | | |
| Contact Size | 8 | | |

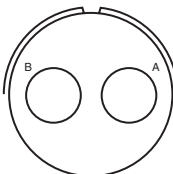
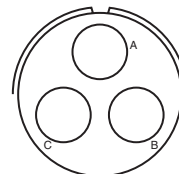
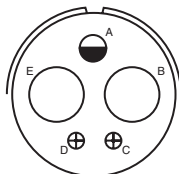
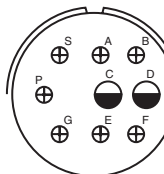

| | | |
|--------------------|-----------------------|----|
| Insert Arrangement | 28-4 | |
| Service Rating | G, P, S = E; Bal. = D | |
| Number of Contacts | 2 | 7 |
| Contact Size | 12 | 16 |

| | | | |
|--------------------|------|----|----|
| Insert Arrangement | 28-5 | | |
| Service Rating | D | | |
| Number of Contacts | 2 | 1 | 2 |
| Contact Size | 4 | 12 | 16 |

| | | | |
|--------------------|------|--|--|
| Insert Arrangement | 28-6 | | |
| Service Rating | D | | |
| Number of Contacts | 3 | | |
| Contact Size | 4 | | |

| | | | |
|--------------------|------|--|--|
| Insert Arrangement | 28-7 | | |
| Service Rating | D | | |
| Number of Contacts | 2 | | |
| Contact Size | 4 | | |

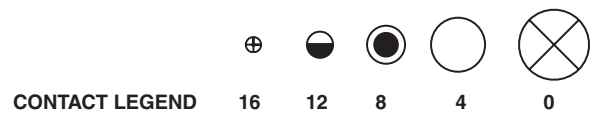

QWL contact arrangements

front face of pin insert or rear face of socket insert illustrated

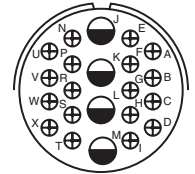
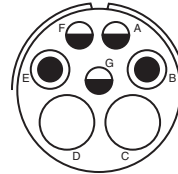

| | |
|---------------------------|---------------------------|
| Insert Arrangement | 28-8 |
| Service Rating | L, M = E; B = D; Bal. = A |
| Number of Contacts | 2 10 |
| Contact Size | 12 16 |

| |
|-------------|
| 28-9 |
| D |
| 6 6 |
| 12 16 |

| |
|-----------------|
| 28-10 |
| G = D; Bal. = A |
| 2 2 3 |
| 4 8 12 |

| |
|--------------|
| 28-11 |
| A |
| 4 18 |
| 12 16 |

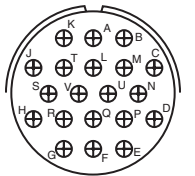
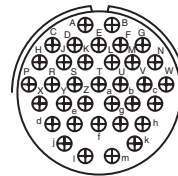

| | |
|---------------------------|--------------|
| Insert Arrangement | 28-12 |
| Service Rating | A |
| Number of Contacts | 26 |
| Contact Size | 16 |

100° Rotation
of 28-12

| |
|--------------|
| 28-13 |
| A |
| 26 |
| 16 |

| |
|--------------|
| 28-15 |
| A |
| 35 |
| 16 |

| |
|--------------|
| 28-16 |
| A |
| 20 |
| 16 |



| | |
|---------------------------|--------------------------------|
| Insert Arrangement | 28-17 |
| Service Rating | R = B; M, N, P = D; A to L = A |
| Number of Contacts | 15 |
| Contact Size | 16 |

| |
|--|
| 28-18 |
| M = C; G, H, J, K, L = D; A, B = A; Bal. = Inst. |
| 12 |
| 16 |

| |
|------------------------------|
| 28-19 |
| H, M = B; A, B = D; Bal. = A |
| 4 6 |
| 12 16 |



QWL contact arrangements

front face of pin insert or rear face of socket insert illustrated

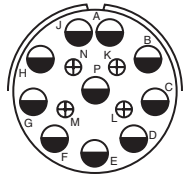

28-20

Insert Arrangement

Service Rating

Number of Contacts

Contact Size

A

10 4

12 16

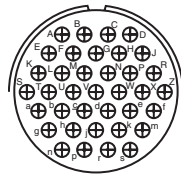

28-21

A

37

16

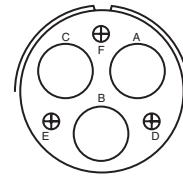

28-22

D

3 3

4 16

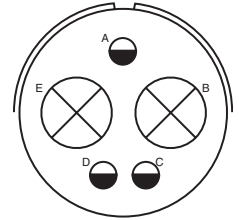

32-1

A = E; B, C, D, E = D

2 3

0 12

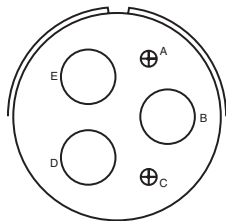

32-2

Insert Arrangement

Service Rating

Number of Contacts

Contact Size

E

3 2

4 16

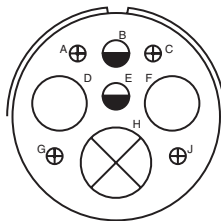

32-3

D

1 2 2 4

0 4 12 16

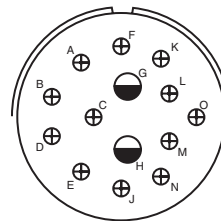

32-4

F, J, K, N = A; Bal. = D

2 12

12 16

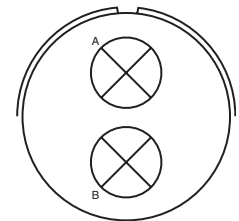

32-5

D

2

0

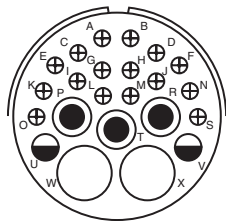

32-6

Insert Arrangement

Service Rating

Number of Contacts

Contact Size

A

2 3 2 16

4 8 12 16

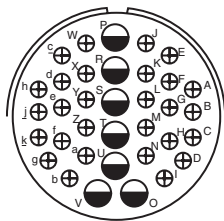

32-7

A, B, h, j = Inst.; Bal. = A

7 28

12 16

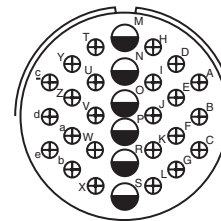

32-8

A

6 24

12 16

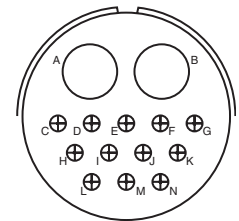

32-9

D

2 12

4 16

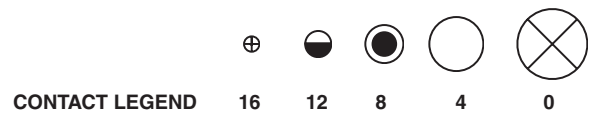

CONTACT LEGEND

16

12

8

4

0

QWL contact arrangements

front face of pin insert or rear face of socket insert illustrated

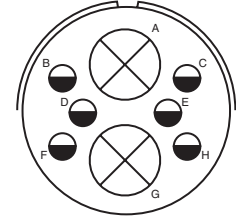
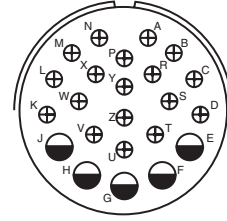
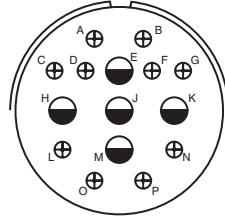
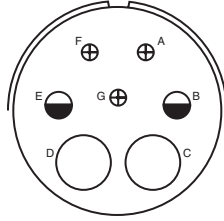

Insert Arrangement

Service Rating

Number of Contacts

Contact Size

| | 32-10 | 32-12 | 32-13 | 32-15 |
|--------------------|-------------------------------------|-----------------------------|-------|-------|
| Service Rating | A, F = E; G = B; B, E = D; C, D = A | C, D, E, F, G = A; Bal. = D | D | D |
| Number of Contacts | 2 2 3 | 5 10 | 5 18 | 2 6 |
| Contact Size | 4 8 16 | 12 16 | 12 16 | 0 12 |

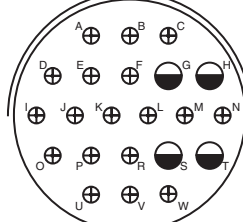
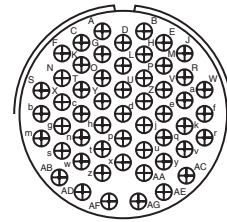
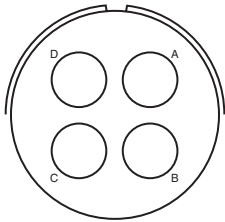
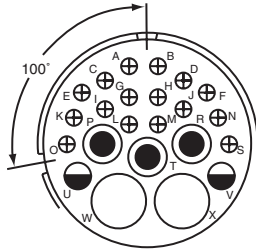

100° Rotation
of 32-6

Insert Arrangement

Service Rating

Number of Contacts

Contact Size

| | 32-16 | 32-17 | 32-22 | 36-1 |
|--------------------|-----------|-------|-------|-------|
| Service Rating | A | D | A | D |
| Number of Contacts | 2 3 2 16 | 4 | 54 | 4 18 |
| Contact Size | 4 8 12 16 | 4 | 16 | 12 16 |

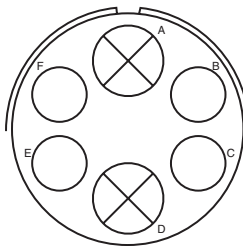
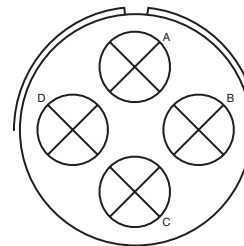
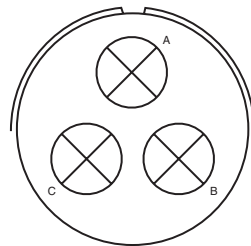
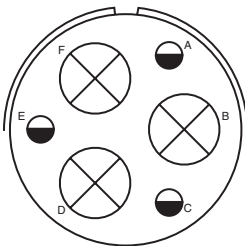

Insert Arrangement

Service Rating

Number of Contacts

Contact Size

| | 36-3 | 36-4 | 36-5 | 36-6 |
|--------------------|------|-----------------|------|------|
| Service Rating | D | A = D; B, C = A | A | A |
| Number of Contacts | 3 3 | 3 | 4 | 2 4 |
| Contact Size | 0 12 | 0 | 0 | 0 4 |



CONTACT LEGEND

16 12 8 4 0

QWL contact arrangements

front face of pin insert or rear face of socket insert illustrated

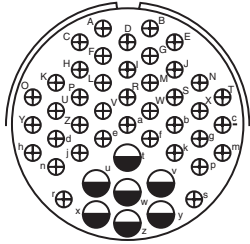

| | |
|--------------------|-------|
| Insert Arrangement | 36-7 |
| Service Rating | A |
| Number of Contacts | 7 40 |
| Contact Size | 12 16 |

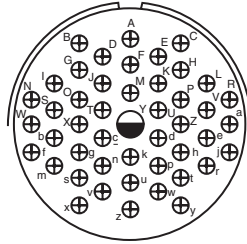

| | |
|--------------------|-------|
| Insert Arrangement | 36-8 |
| Service Rating | A |
| Number of Contacts | 1 46 |
| Contact Size | 12 16 |



| | |
|--------------------|-----------|
| Insert Arrangement | 36-9 |
| Service Rating | A |
| Number of Contacts | 1 2 14 14 |
| Contact Size | 4 8 12 16 |

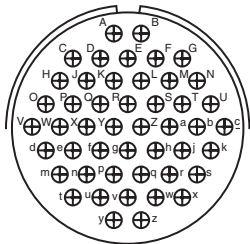

| | |
|--------------------|-------|
| Insert Arrangement | 36-10 |
| Service Rating | A |
| Number of Contacts | 48 |
| Contact Size | 16 |

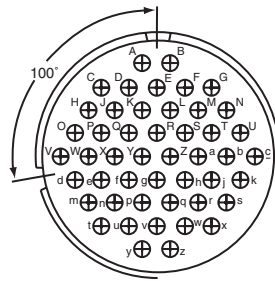

| | |
|--------------------|-------|
| Insert Arrangement | 36-11 |
| Service Rating | A |
| Number of Contacts | 48 |
| Contact Size | 16 |

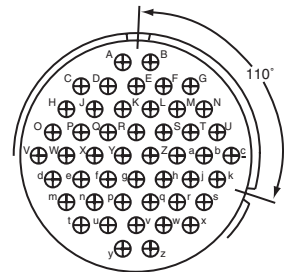

| | |
|--------------------|-------|
| Insert Arrangement | 36-12 |
| Service Rating | A |
| Number of Contacts | 48 |
| Contact Size | 16 |

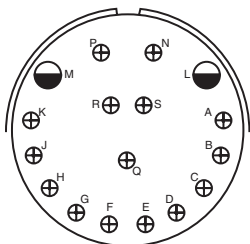

| | |
|--------------------|-----------------------|
| Insert Arrangement | 36-13 |
| Service Rating | N, P, Q = E; Bal. = A |
| Number of Contacts | 2 15 |
| Contact Size | 12 16 |

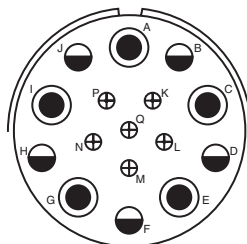

| | |
|--------------------|---------|
| Insert Arrangement | 36-14 |
| Service Rating | D |
| Number of Contacts | 5 5 6 |
| Contact Size | 8 12 16 |

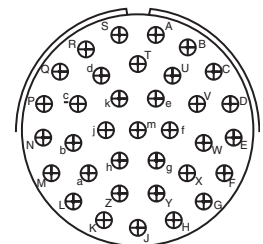

| | |
|--------------------|-----------------|
| Insert Arrangement | 36-15 |
| Service Rating | M = D; Bal. = A |
| Number of Contacts | 35 |
| Contact Size | 16 |



CONTACT LEGEND

16 12 8 4 0

QWL contact arrangements

front face of pin insert or rear face of socket insert illustrated

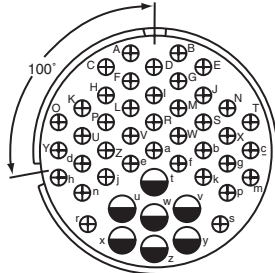

100° Rotation
of 36-7
36-16
A
7 40
12 16

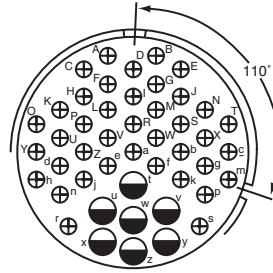

110° Rotation
of 36-7
36-17
A
7 40
12 16

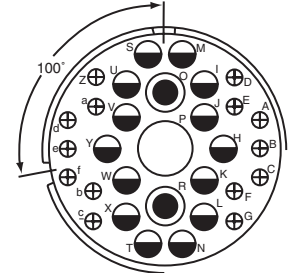

100° Rotation
of 36-9
36-18
A
1 2 14 14
4 8 12 16

Insert Arrangement
Service Rating
Number of Contacts
Contact Size

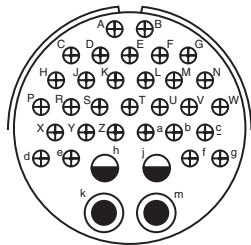

36-20
A
2 2 30
8 12 16

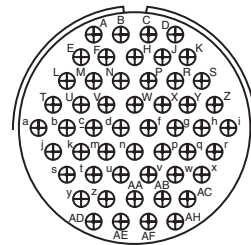

36-52
A
52
16

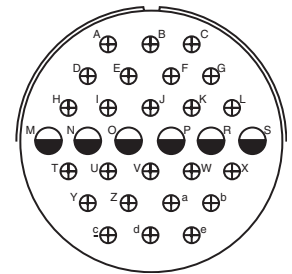

40-1
D
6 24
12 16

Insert Arrangement
Service Rating
Number of Contacts
Contact Size

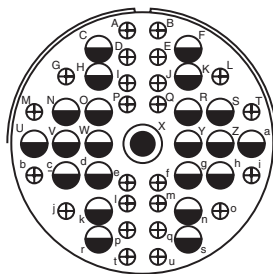

40-9
A
1 22 24
8 12 16

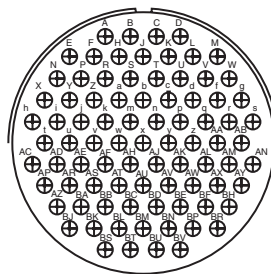

40-56
A
85
16

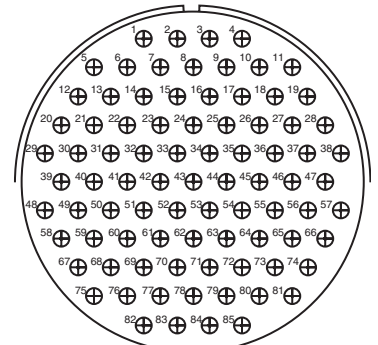

48-62
D
85
16

Insert Arrangement
Service Rating
Number of Contacts
Contact Size

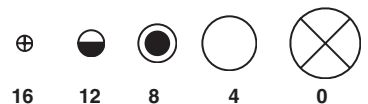

CONTACT LEGEND

16 12 8 4 0

Special contact arrangements

Requirements for more complex circuits prompted Amphenol to provide inserts not covered by the MS drawings. Illustrated here and on the following pages are insert layouts which have from one contact (high tension) to the 104 contact insert in shell size 44.

Many of these special inserts are also available in alternate keyway arrangements. Please contact Amphenol, Sidney, NY for additional information on special circuit application requirements.

front face of pin insert or rear face of socket insert illustrated



| | | | | | | |
|--------------------|--------|-------|-------|-------|-----------------------|-------|
| Insert Arrangement | 14S-A7 | 16-59 | 20-26 | 20-51 | 20-57 | 20-58 |
| Service Rating | A | A | A | A | A | A |
| Number of Contacts | 7 | 4 | 19 | 3* | 7* | 5 5 |
| Contact Size | 16 | 12 | 16 | 8 | 12 for #14 or 16 wire | 12 16 |



| | | | | | | |
|--------------------|----------------------|--------------------|--------------------|-------|-----------------------|-------|
| Insert Arrangement | 20-59 | 20-66 | 20-79 | 22-63 | 22-65 | 22-70 |
| Service Rating | A | A | H = D; Bal. = A | A | H = D; Bal. = A | A |
| Number of Contacts | 3* | 1 5 | 7* 1* | 4 8 | 8* | 8 5 |
| Contact Size | 8 for #10 or 12 wire | 16 12 for #10 wire | 16 12 for #16 wire | 12 16 | 12 for #14 or 16 wire | 12 16 |



| | | | | | | |
|--------------------|----------------------|-------|--|---------|-------|---------|
| Insert Arrangement | 22-80 | 24-19 | 24-51 | 24-52 | 24-53 | 24-58 |
| Service Rating | A | A | A | Hi-Volt | A | A |
| Number of Contacts | 3* | 12 | 5* | 1 | 5* | 3 3 7 |
| Contact Size | 8 for #10 or 12 wire | 16 | B, E for AN #10 or 12 wire A, C, D for AN #8 wire | 12 | 8 | 8 12 16 |

* Solderless

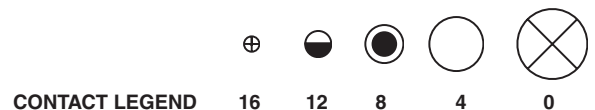

Special contact arrangements

front face of pin insert or rear face of socket insert illustrated

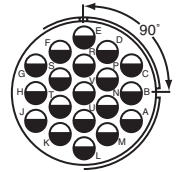
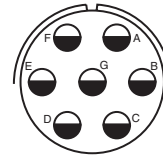
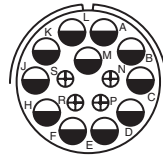
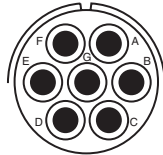
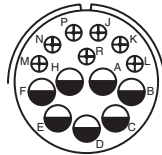

| | | | | | |
|--------------------|-------|----------------------|-------|-------|-------|
| Insert Arrangement | 24-59 | 24-60 | 24-65 | 24-66 | 24-67 |
| Service Rating | A | A | A | D | Inst. |
| Number of Contacts | 7 7 | 7* | 11 4 | 7 | 19 |
| Contact Size | 12 16 | 8 for #10 or 12 wire | 12 16 | 12 | 12 |

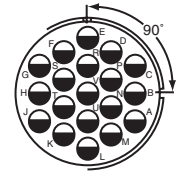
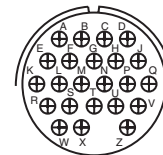
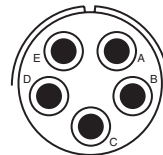
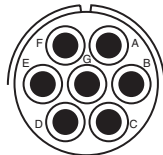
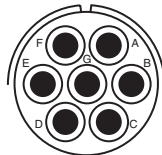

| | | | | | |
|--------------------|------------------------|------------------|-------|-------|-----------------------------------|
| Insert Arrangement | 24-71 | 24-75 | 24-79 | 24-80 | 24-84 |
| Service Rating | A | A | A | Inst. | A |
| Number of Contacts | 2* 5* | 5 2 | 5 | 23 | 1 18 |
| Contact Size | 8 8 for #10 or 12 wire | 8 8 for #16 wire | 8 | 16 | 12 12 (Coax) RG-188/U or RG-174/U |

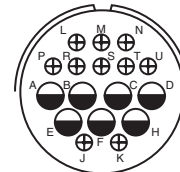
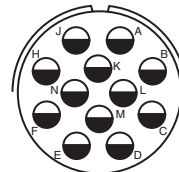
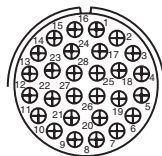

| | | | | |
|--------------------|-------|-------|-------|-------|
| Insert Arrangement | 24-96 | 24-AJ | 28-51 | 28-59 |
| Service Rating | Inst. | A | A | A |
| Number of Contacts | 28 | 25 | 12 | 7 10 |
| Contact Size | 16 | 16 | 12 | 12 16 |

* Solderless



Special contact arrangements

front face of pin insert or rear face of socket insert illustrated

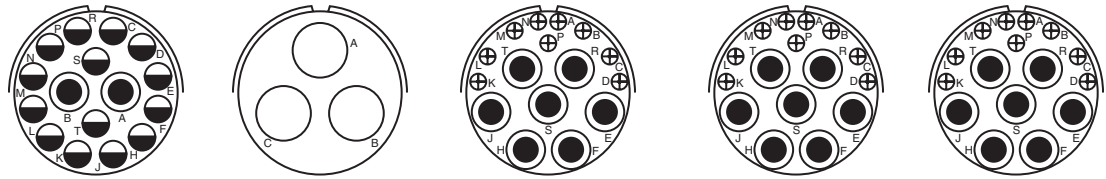

| Insert Arrangement | 28-66 | 28-72 | 28-74 | 28-75 | 28-79 |
|--------------------|-------|-------------------------------|-------------------------------|-------------------|-------|
| Service Rating | A | — | A | A | A |
| Number of Contacts | 2 14 | 3 | 9* 4* 3* | 9* 7* | 7 9 |
| Contact Size | 8 12 | 4 (Coax) RG-59A/U or RG-62A/U | 16 8 8 for #10 wire (S, T, R) | 16 8 for #10 wire | 8 16 |

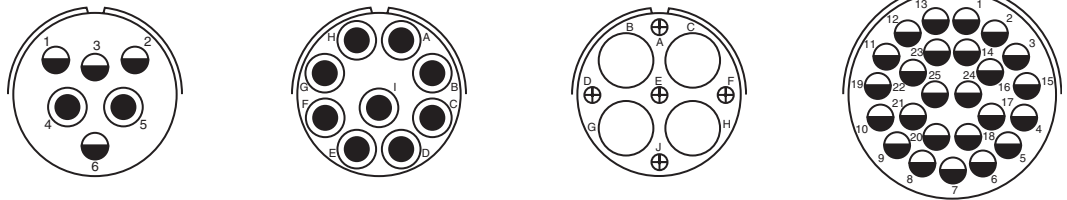

| Insert Arrangement | 28-82 | 28-84 | 28-AY | 32-25 |
|--------------------|-------|-------|-------|-------|
| Service Rating | D | A | A | A |
| Number of Contacts | 2 4 | 9 | 4 5 | 25 |
| Contact Size | 8 12 | 8 | 4 16 | 12 |



| Insert Arrangement | 32-31 | 32-48 | 32-52 | 32-53 |
|--------------------|-------|-------|-------|------------------------|
| Service Rating | A | Inst. | D | t, u = E; Bal. = Inst. |
| Number of Contacts | 31 | 48 | 6 2 | 5 37 |
| Contact Size | 16 | 16 | 12 0 | 12 16 |

* Solderless

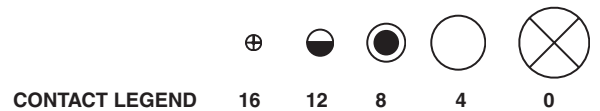

Special contact arrangements

front face of pin insert or rear face of socket insert illustrated

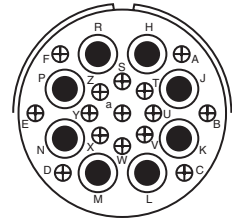
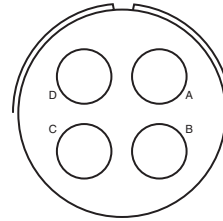
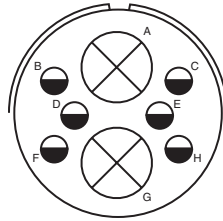
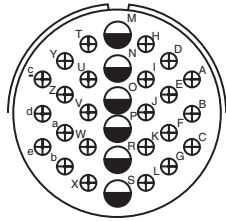

| Insert Arrangement | 32-56 | 32-57 | 32-58 | 32-60 |
|--------------------|--------------------|---------------------|-------------------------------|----------------------|
| Service Rating | A | ** | - | A |
| Number of Contacts | 24 6 | 6 2 | 4 | 15 8 |
| Contact Size | 16 12 for #10 wire | 12 0 (Coax) RG-71/U | 4 (Coax) RG-161/U or RG-179/U | 16 8 (Coax) RG-124/U |

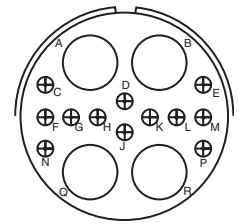
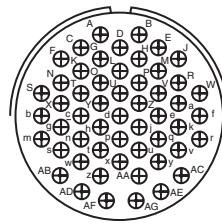
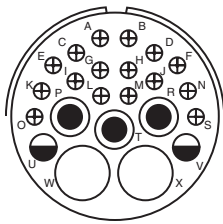

| Insert Arrangement | 32-62 | 32-64 | 32-68 |
|--------------------|-----------------------------|-------|----------------------|
| Service Rating | ** | Inst. | A |
| Number of Contacts | 2 1 2 16 2 | 54 | 12 4 |
| Contact Size | 4 8 12 16 8 (Coax) RG-124/U | 16 | 16 4 (Coax) RG-58C/U |

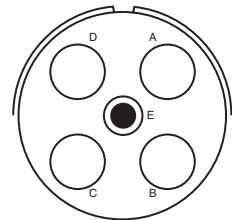
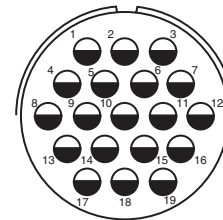
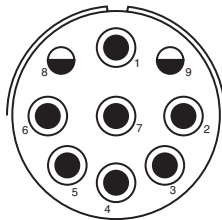
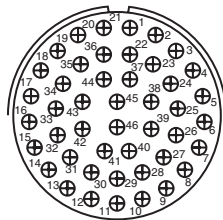

| Insert Arrangement | 32-73 | 32-75 | 32-76 | 32-79 |
|--------------------|-------|-----------------------|-------|-------|
| Service Rating | A | 8, 9 = D | A | D |
| Number of Contacts | 46 | 2 7 | 19 | 4 1 |
| Contact Size | 16 | 12 8 (Coax) RG-180B/U | 12 | 4 8 |

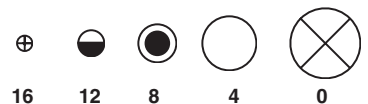

** Consult Amphenol, Sidney, NY for service rating of power contacts.

CONTACT LEGEND

16 12 8 4 0

Special contact arrangements

front face of pin insert or rear face of socket insert illustrated

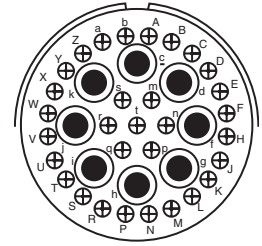
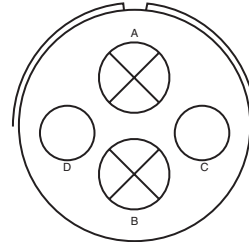
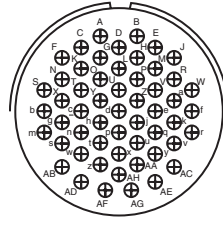
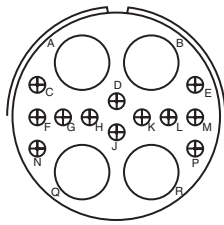

| Insert Arrangement | 32-82 | 32-AF | 36-51 | 36-54 |
|--------------------|-------|-------|-------|-------|
| Service Rating | A | A | D | A |
| Number of Contacts | 4 12 | 55 | 2 2 | 8 31 |
| Contact Size | 4 16 | 16 | 0 4 | 8 16 |

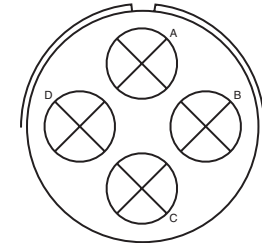
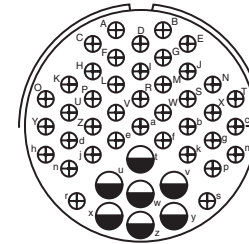
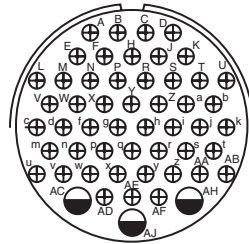
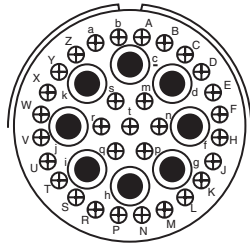

| Insert Arrangement | 36-55 | 36-59 | 36-60 | 36-64 |
|--------------------|------------------|--------------------|--------------------|--------------------------------------|
| Service Rating | A | A | ** | - |
| Number of Contacts | 31 8 | 50 3 | 40 7 | 4 |
| Contact Size | 16 8 for #6 wire | 16 12 for #10 wire | 16 12 for #10 wire | 0 (Coax) RG-11/U, RG-12/U or RG-13/U |

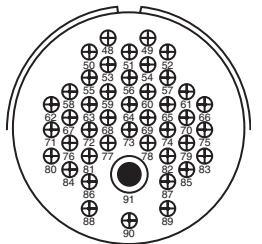
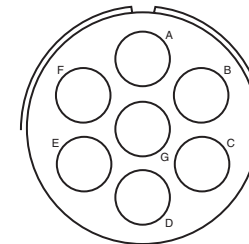
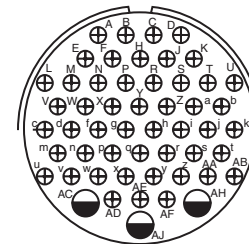
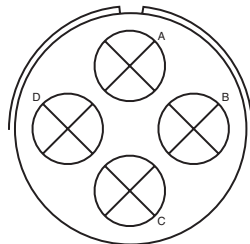

| Insert Arrangement | 36-65 | 36-71 | 36-73 | 36-74 |
|--------------------|--------------------------------------|-------|-------------------|----------------------|
| Service Rating | - | A | - | A |
| Number of Contacts | 4 | 3 50 | 7 | 43 1 |
| Contact Size | 0 (Coax) RG-59/U, RG-62/U or RG-71/U | 12 16 | 4 (Coax) RG-62B/U | 16 8 (Coax) RG-187/U |

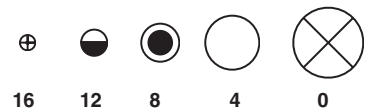

** Consult Amphenol, Sidney, NY for service rating of power contacts.

Special contact arrangements

front face of pin insert or rear face of socket insert illustrated

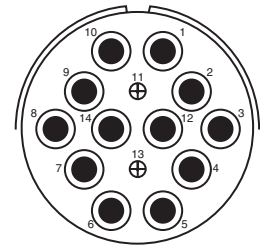
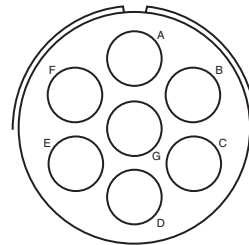
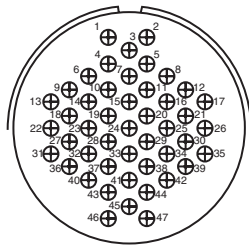
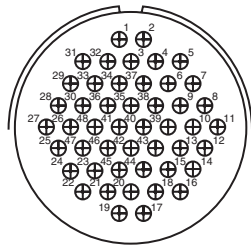

| | | | | |
|--------------------|-----------------|-------|-------|-------|
| Insert Arrangement | 36-75 | 36-76 | 36-77 | 36-78 |
| Service Rating | A | A | D | A |
| Number of Contacts | 48 | 47 | 7 | 2 12 |
| Contact Size | 16 for #14 wire | 16 | 4 | 16 8 |

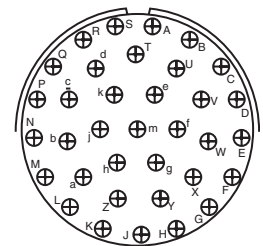
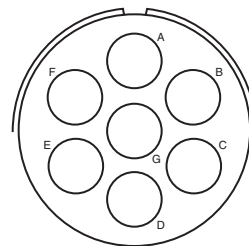
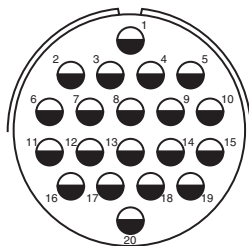
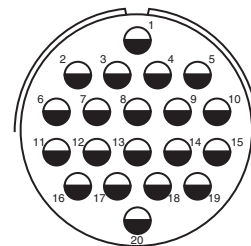

| | | | | |
|--------------------|-------|-----------------|------------------|-----------------|
| Insert Arrangement | 36-79 | 36-80 | 36-83 | 36-85 |
| Service Rating | A | A | - | M = D; Bal. = A |
| Number of Contacts | 20 | 20 | 7 | 35 |
| Contact Size | 12 | 12 for #10 wire | 4 (Coax) RG-58/U | 16 for #12 wire |

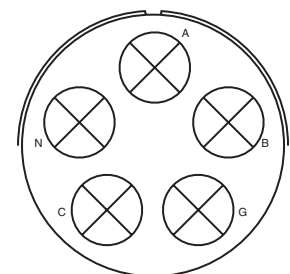
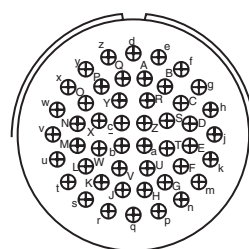
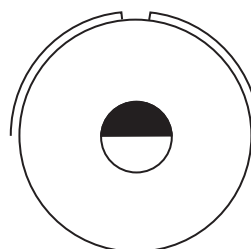

| | | | |
|--------------------|-------|-------|------|
| Insert Arrangement | 36-97 | 36-AF | 40-5 |
| Service Rating | C | A | A |
| Number of Contacts | 1 | 48 | 5 |
| Contact Size | 4/0 | 16 | 0 |



Special contact arrangements

front face of pin insert or rear face of socket insert illustrated

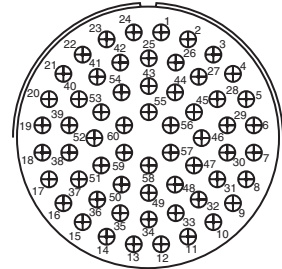
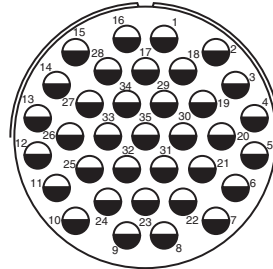
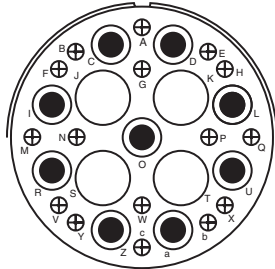

| | |
|---------------------------|---------------|
| Insert Arrangement | 40-10 |
| Service Rating | A |
| Number of Contacts | 4 9 16 |
| Contact Size | 4 8 16 |

| | |
|---------------------------|--------------|
| Insert Arrangement | 40-35 |
| Service Rating | D |
| Number of Contacts | 35 |
| Contact Size | 12 |

| | |
|---------------------------|--------------|
| Insert Arrangement | 40-53 |
| Service Rating | A |
| Number of Contacts | 60 |
| Contact Size | 16 |

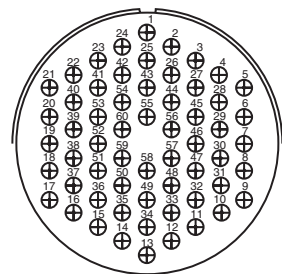
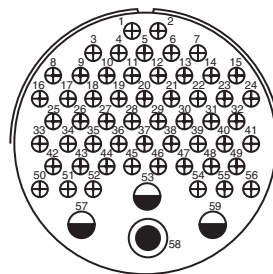
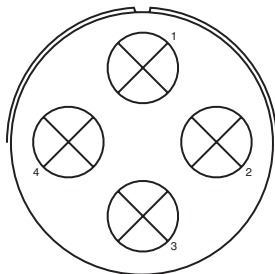

| | |
|---------------------------|--------------|
| Insert Arrangement | 40-57 |
| Service Rating | E |
| Number of Contacts | 4 |
| Contact Size | 0 |

| | |
|---------------------------|----------------|
| Insert Arrangement | 40-61 |
| Service Rating | A |
| Number of Contacts | 1 3 55 |
| Contact Size | 8 12 16 |

| | |
|---------------------------|--------------|
| Insert Arrangement | 40-62 |
| Service Rating | A |
| Number of Contacts | 60 |
| Contact Size | 16 |

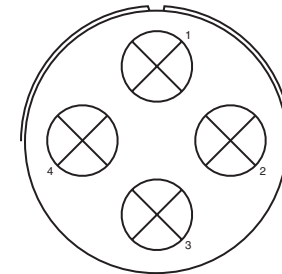
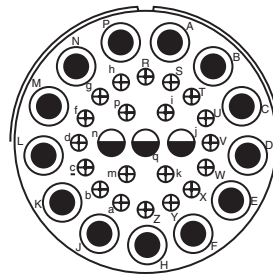
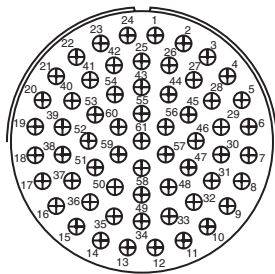

| | |
|---------------------------|------------------------|
| Insert Arrangement | 40-63 |
| Service Rating | A |
| Number of Contacts | 61 |
| Contact Size | 16 for #14 wire |

| | |
|---------------------------|--------------------------------|
| Insert Arrangement | 40-64 |
| Service Rating | - |
| Number of Contacts | 3 20 13 |
| Contact Size | 12 16 8 (Coax) RG-124/U |

| | |
|---------------------------|--------------------------|
| Insert Arrangement | 40-66 |
| Service Rating | - |
| Number of Contacts | 4 |
| Contact Size | 0 (Coax) RG-63B/U |

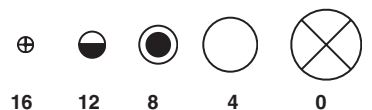

CONTACT LEGEND

16 12 8 4 0

Special contact arrangements

front face of pin insert or rear face of socket insert illustrated

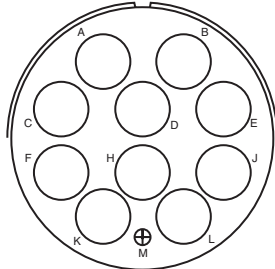

Insert Arrangement 40-67
Service Rating A
Number of Contacts 1 10
Contact Size 16 4 (Coax) RG-59/U

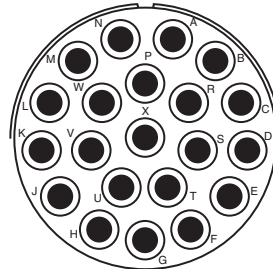

Insert Arrangement 40-68
Service Rating A
Number of Contacts 21
Contact Size 8

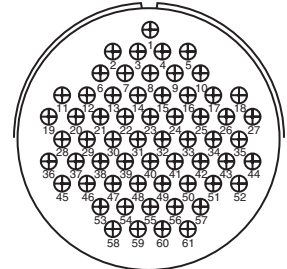

Insert Arrangement 40-70
Service Rating A
Number of Contacts 61
Contact Size 16

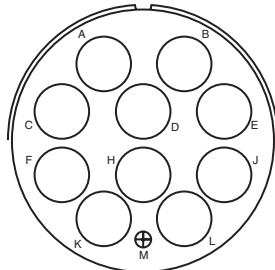

Insert Arrangement 40-72
Service Rating A
Number of Contacts 1 10
Contact Size 16 4 (Coax) RG-9B/U

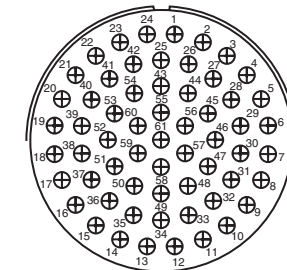

Insert Arrangement 40-73
Service Rating A
Number of Contacts 61
Contact Size 16

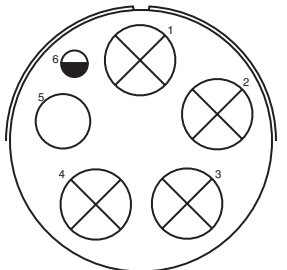

Insert Arrangement 40-74
Service Rating A
Number of Contacts 1 1 4
Contact Size 12 4 (Coax) RG-62/U 0 (Coax) RG-9B/U or RG-214/U

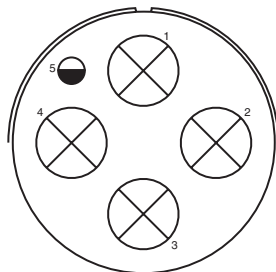

Insert Arrangement 40-75
Service Rating E
Number of Contacts 1 4
Contact Size 12 0

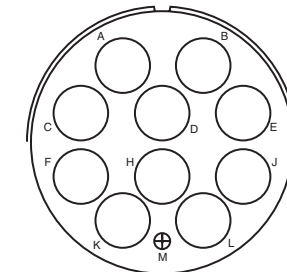

Insert Arrangement 40-80
Service Rating A
Number of Contacts 1 10
Contact Size 16 4

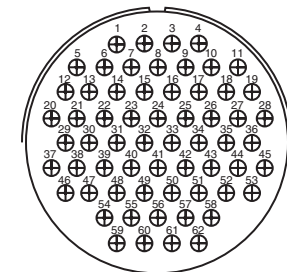

Insert Arrangement 40-81
Service Rating A
Number of Contacts 62
Contact Size 16 for #14 wire

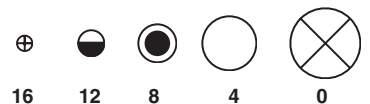

CONTACT LEGEND

16 12 8 4 0

Special contact arrangements

front face of pin insert or rear face of socket insert illustrated

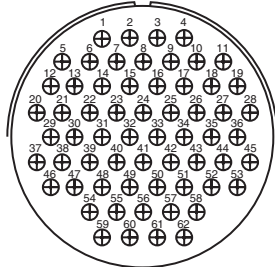

40-82

Insert Arrangement
Service Rating
Number of Contacts
Contact Size

A
62
16

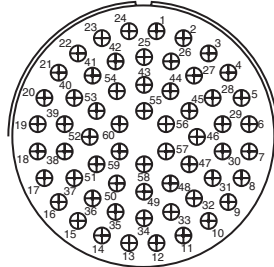

40-85

A
60
16 for #14 wire

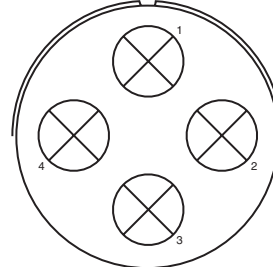

40-86

-
4
0(Coax) RG-115A/U

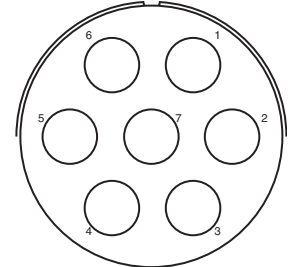

40-87

D
7
4

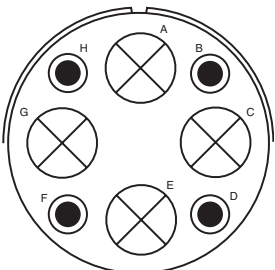

40-AD

Insert Arrangement
Service Rating
Number of Contacts
Contact Size

A
4 4
8 0

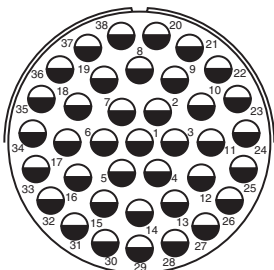

40-AG

A
38
12

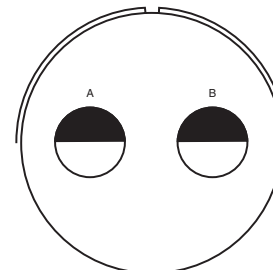

40-AP

E
2
4/0

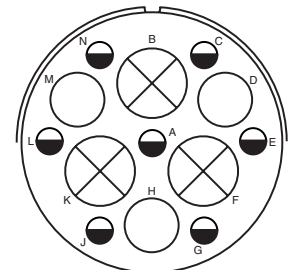

40-AR

Inst.
7 3 3
12 4 0

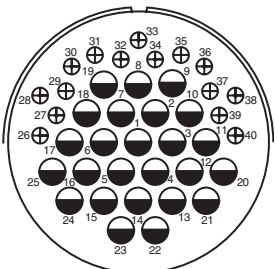

40-AS

Insert Arrangement
Service Rating
Number of Contacts
Contact Size

A
15 25
16 12

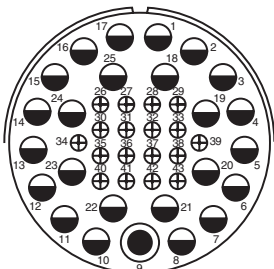

40-AT

A
24 18 1
12 16 8

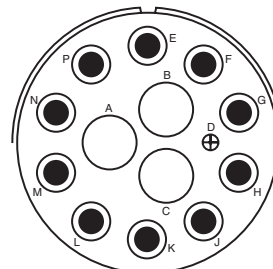

40-AU

A
3 10 1
4 8 16

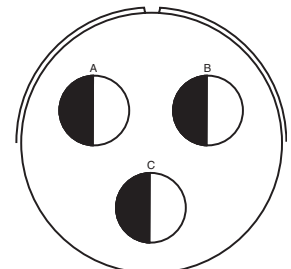

40-AV

D
3
2/0

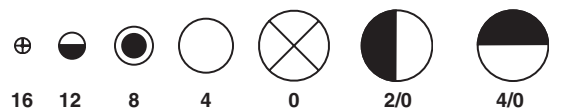

CONTACT LEGEND

16 12 8 4 0 2/0 4/0

Special contact arrangements

front face of pin insert or rear face of socket insert illustrated

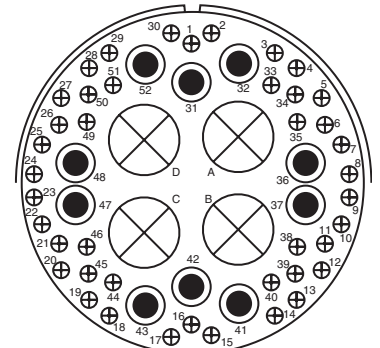
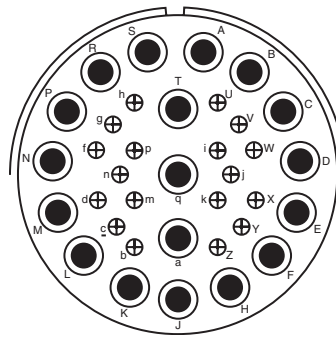
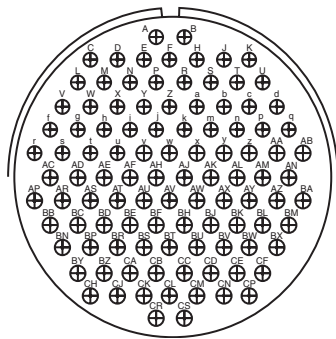

| Insert Arrangement | 44-52 | 44-53 | 48-51 |
|--------------------|-------|----------------------|-----------------------|
| Service Rating | A | A | A |
| Number of Contacts | 104 | 18 | 42 10 4 |
| Contact Size | 16 | 16 8 (Coax) RG-124/U | 16 8 0 (Coax) RG-41/U |

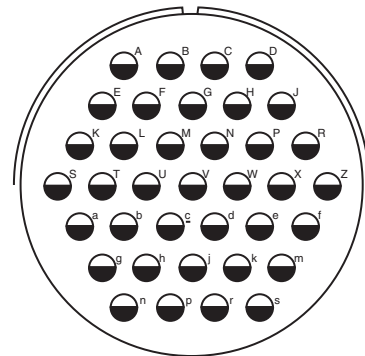
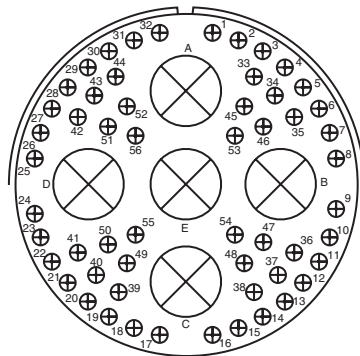

| Insert Arrangement | 48-52 | 48-53 |
|--------------------|---------------------|-------|
| Service Rating | A | D |
| Number of Contacts | 56 5 | 37 |
| Contact Size | 16 0 (Coax) RG-41/U | 12 |



Special contact arrangements

front face of pin insert or rear face of socket insert illustrated

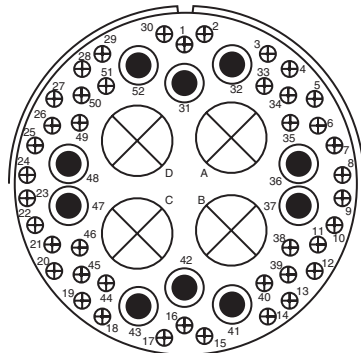

48-54

Insert Arrangement
Service Rating
Number of Contacts
Contact Size

A
42 10 4
16 8 0 (Coax) RG-59/U

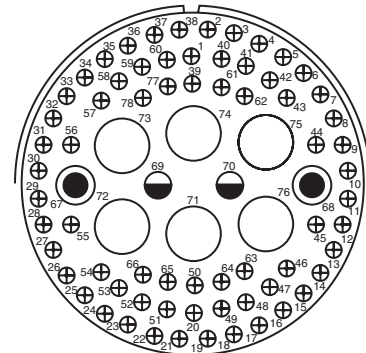

48-55

A
68 2 2 6
16 12 8 4



48-57

Insert Arrangement
Service Rating
Number of Contacts
Contact Size

A
42 10 4
16 8 0



48-60

A
42 10 4
16 8 0 (Coax) RG-214/U



CONTACT LEGEND 16 12 8 4 0

QWL – accessories cabling information

The Amphenol® QWL series of electrical connectors has been designed with the problems of multi-conductor cable users in mind. Two of these problems, namely water proofing and strain relief, are solved by the radial inward compression of an internal neoprene gland in the various cable accessories shown on the following pages. For additional strain relief beyond that provided by the gland, both cable grips and bar clamps are available. Since the glands close down from .094” to .145” (depending on shell size), the optimum condition for cable users is to select a gland with an I.D. only slightly larger than the maximum O.D. of the cable. The inside diameter of the accessory housing determines the maximum diameter of the cable as shown in the tabulation below. Smaller sizes than those shown in each shell size can be accommodated by smaller compression glands.

Different cable manufacturers use different constructions and cable lays in manufacturing multi-conductor cable. The specific cabling manufacturing specification should be known by the customer in detail in order to properly figure each QWL application. This knowledge can save many individual wire crossovers in any given run of cable. Crossovers add materially to the cable diameter without a cable accessory. In those cases where diameter buildup is impossible to avoid, special cable accessories with longer barrels are available.

How to order information is covered in detail on pages 4 and 5. In selecting the base number below, care should be used, as some of the cable accessories are provided with protection cap attachment rings, while others are provided with the Kellems strain relief grip as shown. If a type or cable accommodation size is not found herein that fulfills your application, please contact Amphenol, Sidney, NY.

All dimensions for reference only.

| Shell Size | QWL Connector Accessory Thd. | Approx. Work Length (Internal) | | Minimum Housing Inner Diameter | Maximum Cable Outer Diameter |
|------------|------------------------------|--------------------------------|-------|--------------------------------|------------------------------|
| | | Short | Long | | |
| 10 | .500-28 | .250 | | .359 | .359 |
| 12 | .625-24 | .375 | | .484 | .484 |
| 14 | .750-20 | .401 | | .609 | .609 |
| 16 | .875-20 | .500 | | .734 | .734 |
| 18 | 1.000-20 | 1.120 | | .859 | .859 |
| 20 | 1.125-18 | 1.370 | | .984 | .984 |
| 22 | 1.250-18 | 1.370 | | 1.109 | 1.109 |
| 24 | 1.375-18 | 1.370 | | 1.234 | 1.234 |
| 28 | 1.625-18 | 1.370 | 5.000 | 1.427 | 1.427 |
| 32 | 1.875-16 | 1.370 | 6.000 | 1.708 | 1.708 |
| 36 | 2.062-16 | 1.370 | 5.000 | 1.895 | 1.895 |
| 40 | 2.312-16 | 1.370 | 6.000 | 2.130 | 2.130 |
| 44 | 2.625-16 | | | 2.375 | 2.375 |
| 48 | 2.875-16 | 2.218 | 6.000 | 2.630 | 2.630 |

QWL – cable accessories



10-101332
Short barrel with grip



10-101335
Short barrel with attachment ring

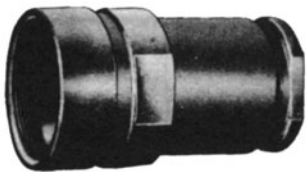

10-101333
Short barrel without grip

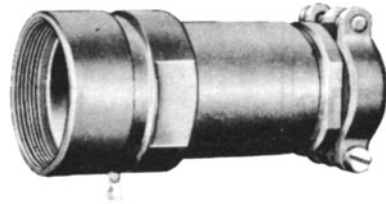

10-130380
Short barrel length with attachment ring & strain relief bars

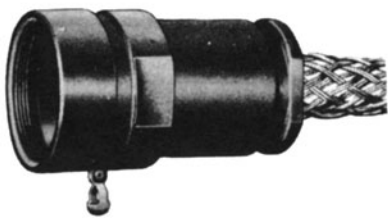

10-101334
Short barrel with grip & attachment ring



10-113637
Long barrel with attachment ring and grip

QWL – accessories

10-130380

cable sealing adapter (with clamp bars)

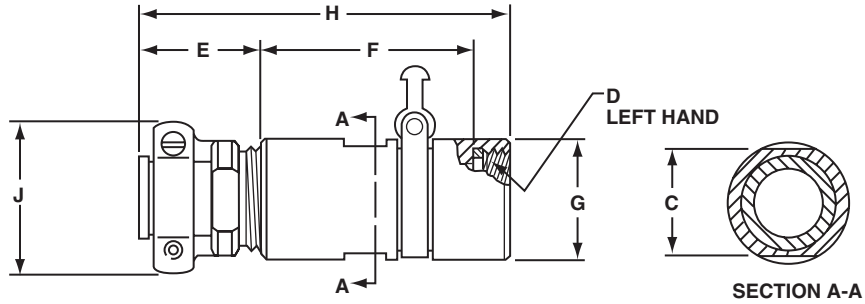
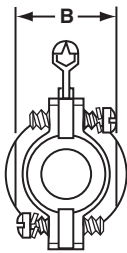

Type I Straight

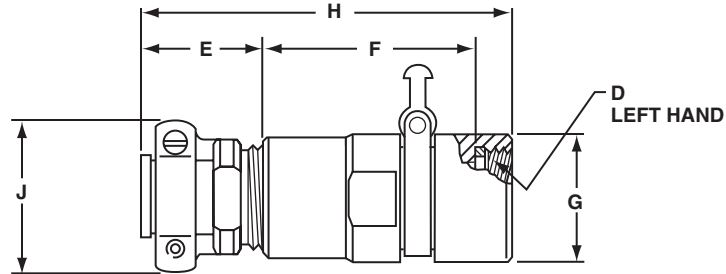
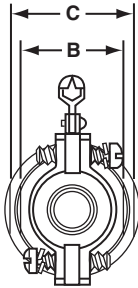

Type II Step Down

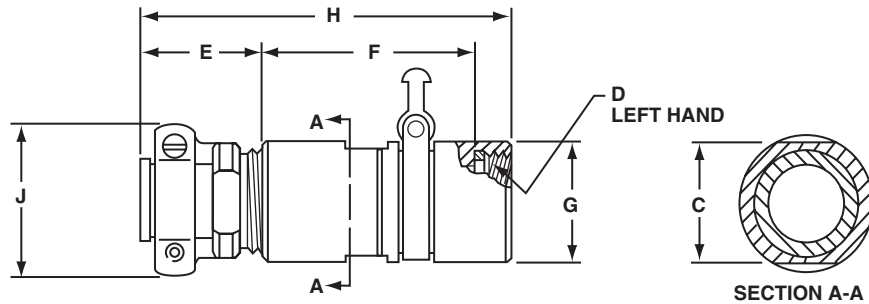
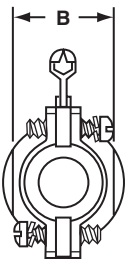

Type III Step Up

QWL – accessories

10-130380

cable sealing adapter (with clamp bars)

All dimensions are for reference only.

| Part Number* | Used With Shell Size | Cable Range | | B +.000 -.010 | C +.010 -.000 | D Thread Class 2B-LH | E Free Max | F +.010 -.020 | G Dia. +.010 -.020 | H Max. | J Max. | Type |
|---------------|----------------------|--------------|--------------|---------------------|---------------------|-------------------------|------------------|---------------------|-----------------------------|-----------|-----------|------|
| | | Max. Dia. | Min. Dia. | | | | | | | | | |
| 10-130380-141 | 14S | .460 | .366 | .750 | .812 | .750-20UNEF | 1.125 | 1.782 | .938 | 3.229 | 1.062 | I |
| 10-130380-142 | 14S | .438 | .344 | .875 | .938 | .750-20UNEF | 1.125 | 2.126 | .938 | 3.573 | 1.125 | III |
| 10-130380-143 | 14S | .375 | .306 | .875 | .938 | .750-20UNEF | 1.125 | 2.126 | .938 | 3.573 | 1.125 | III |
| 10-130380-161 | 16S | .530 | .436 | 1.000 | 1.062 | .875-20UNEF | 1.250 | 2.282 | 1.062 | 3.854 | 1.375 | III |
| 10-130380-162 | 16S | .605 | .511 | 1.000 | 1.062 | .875-20UNEF | 1.250 | 2.282 | 1.062 | 3.854 | 1.375 | III |
| 10-130380-171 | 16 | .500 | .406 | .875 | .938 | .875-20UNEF | 1.125 | 2.215 | 1.062 | 3.834 | 1.125 | I |
| 10-130380-181 | 18 | .828 | .715 | 1.188 | 1.250 | 1.000-20UNEF | 1.250 | 3.032 | 1.188 | 4.776 | 1.688 | III |
| 10-130380-182 | 18 | .699 | .605 | 1.062 | 1.125 | 1.000-20UNEF | 1.250 | 2.933 | 1.188 | 4.677 | 1.562 | III |
| 10-130380-183 | 18 | .500 | .406 | .875 | 1.094 | 1.000-20UNEF | 1.125 | 2.485 | 1.188 | 4.104 | 1.125 | II |
| 10-130380-184 | 18 | .562 | .449 | 1.188 | 1.250 | 1.000-20UNEF | 1.250 | 3.032 | 1.188 | 4.776 | 1.688 | III |
| 10-130380-185 | 18 | .750 | .637 | 1.312 | 1.000 | 1.000-20UNEF | 1.250 | 3.063 | 1.188 | 4.607 | 1.812 | III |
| 10-130380-186 | 18 | .530 | .436 | 1.000 | 1.062 | 1.000-20UNEF | 1.250 | 2.621 | 1.188 | 4.365 | 1.375 | I |
| 10-130380-201 | 20 | .625 | .531 | 1.062 | 1.125 | 1.125-18UNEF | 1.250 | 2.933 | 1.312 | 4.677 | 1.562 | I |
| 10-130380-202 | 20 | .605 | .511 | 1.000 | 1.125 | 1.125-18UNEF | 1.250 | 2.631 | 1.312 | 4.365 | 1.375 | II |
| 10-130380-203 | 20 | .628 | .715 | 1.188 | 1.125 | 1.125-18UNEF | 1.250 | 2.996 | 1.312 | 4.740 | 1.688 | III |
| 10-130380-204 | 20 | .720 | .626 | 1.062 | 1.125 | 1.125-18UNEF | 1.250 | 2.933 | 1.312 | 4.677 | 1.562 | I |
| 10-130380-205 | 20 | .900 | .787 | 1.312 | 1.250 | 1.125-18UNEF | 1.250 | 3.062 | 1.312 | 4.807 | 1.812 | III |
| 10-130380-206 | 20 | .625 | .531 | 1.062 | 1.125 | 1.125-18UNEF | 1.250 | 2.933 | 1.312 | 4.677 | 1.562 | I |
| 10-130380-207 | 20 | .750 | .637 | 1.312 | 1.250 | 1.125-18UNEF | 1.250 | 3.063 | 1.312 | 4.807 | 1.812 | III |
| 10-130380-221 | 22 | .790 | .696 | 1.062 | 1.250 | 1.250-18UNEF | 1.250 | 2.933 | 1.438 | 4.677 | 1.562 | II |
| 10-130380-222 | 22 | .720 | .626 | 1.062 | 1.250 | 1.250-18UNEF | 1.250 | 2.933 | 1.438 | 4.677 | 1.562 | II |
| 10-130380-223 | 22 | 1.130 | 1.005 | 1.780 | 1.375 | 1.250-18UNEF | 1.500 | 3.266 | 1.438 | 5.250 | 2.469 | III |
| 10-130380-224 | 22 | .680 | .567 | 1.312 | 1.375 | 1.250-18UNEF | 1.250 | 3.059 | 1.438 | 4.803 | 1.812 | III |
| 10-130380-242 | 24 | .900 | .787 | 1.312 | 1.375 | 1.375-18UNEF | 1.250 | 3.059 | 1.562 | 4.803 | 1.812 | I |
| 10-130380-243 | 24 | 1.180 | 1.055 | 1.780 | 1.812 | 1.375-18UNEF | 1.500 | 3.204 | 1.562 | 5.198 | 2.469 | III |
| 10-130380-244 | 24 | .680 | .567 | 1.312 | 1.375 | 1.375-18UNEF | 1.250 | 3.059 | 1.562 | 4.803 | 1.812 | I |
| 10-130380-245 | 24 | .630 | .517 | 1.312 | 1.375 | 1.375-18UNEF | 1.250 | 3.059 | 1.562 | 4.803 | 1.812 | I |
| 10-130380-246 | 24 | 1.000 | .875 | 1.546 | 1.625 | 1.375-18UNEF | 1.500 | 3.121 | 1.562 | 5.115 | 2.125 | III |
| 10-130380-247 | 24 | .805 | .692 | 1.312 | 1.375 | 1.375-18UNEF | 1.250 | 3.059 | 1.562 | 4.803 | 1.812 | I |
| 10-130380-281 | 28 | 1.310 | 1.185 | 1.780 | 1.875 | 1.625-18UNEF | 1.500 | 3.184 | 1.812 | 5.178 | 2.469 | III |
| 10-130380-282 | 28 | .970 | .857 | 1.312 | 1.625 | 1.625-18UNEF | 1.250 | 3.059 | 1.812 | 4.803 | 1.812 | II |
| 10-130380-283 | 28 | .880 | .755 | 1.546 | 1.625 | 1.625-18UNEF | 1.500 | 3.121 | 1.812 | 5.115 | 2.125 | I |
| 10-130380-284 | 28 | 1.427 | 1.320 | 2.000 | 1.875 | 1.625-18UNEF | 1.500 | 3.184 | 1.812 | 5.178 | 2.625 | III |
| 10-130380-321 | 32 | .970 | .875 | 1.312 | 1.875 | 1.875-16UN | 1.250 | 3.059 | 2.062 | 4.803 | 1.812 | II |
| 10-130380-322 | 32 | 1.230 | 1.105 | 1.780 | 1.875 | 1.875-16UN | 1.500 | 3.184 | 2.062 | 5.178 | 2.469 | I |
| 10-130380-323 | 32 | 1.328 | 1.240 | 1.780 | 1.875 | 1.875-16UN | 1.500 | 3.184 | 2.062 | 5.178 | 2.469 | I |
| 10-130380-324 | 32 | .750 | .637 | 1.312 | 1.875 | 1.875-16UN | 1.250 | 3.059 | 2.062 | 4.803 | 1.812 | II |
| 10-130380-325 | 32 | 1.055 | .958 | 1.546 | 1.875 | 1.875-16UN | 1.500 | 3.121 | 2.062 | 5.115 | 2.125 | II |
| 10-130380-326 | 32 | 1.375 | 1.250 | 2.000 | 2.062 | 1.875-16UN | 1.500 | 3.246 | 2.062 | 5.240 | 2.625 | III |
| 10-130380-361 | 36 | 1.310 | 1.185 | 1.780 | 2.062 | 2.0625-16UN | 1.500 | 3.184 | 2.312 | 5.178 | 2.469 | II |
| 10-130380-362 | 36 | 1.900 | 1.775 | 2.438 | 2.312 | 2.0625-16UN | 1.625 | 3.500 | 2.312 | 5.619 | 3.171 | III |
| 10-130380-363 | 36 | 1.530 | 1.406 | 2.000 | 2.062 | 2.0625-16UN | 1.500 | 3.246 | 2.312 | 5.240 | 2.625 | I |
| 10-130380-364 | 36 | 1.445 | 1.320 | 2.000 | 2.062 | 2.0625-16UN | 1.500 | 3.246 | 2.312 | 5.240 | 2.625 | I |
| 10-130380-365 | 36 | .805 | .692 | 1.312 | 2.062 | 2.0625-16UN | 1.250 | 3.059 | 2.312 | 4.803 | 1.812 | II |
| 10-130380-366 | 36 | .603 | .511 | 1.000 | 2.000 | 2.0625-16UN | 1.250 | 2.875 | 2.312 | 4.619 | 1.375 | II |
| 10-130380-367 | 36 | 1.000 | .875 | 1.546 | 2.062 | 2.0625-16UN | 1.500 | 3.121 | 2.312 | 5.115 | 2.125 | II |
| 10-130380-401 | 40 | 1.730 | 1.605 | 2.438 | 2.500 | 2.3125-16UN | 1.625 | 3.469 | 2.562 | 5.588 | 3.171 | III |
| 10-130380-402 | 40 | 1.310 | 1.185 | 1.780 | 2.312 | 2.3125-16UN | 1.500 | 3.184 | 2.562 | 5.178 | 2.469 | II |
| 10-130380-403 | 40 | 1.180 | 1.055 | 1.780 | 2.312 | 2.3125-16UN | 1.500 | 3.184 | 2.562 | 5.178 | 2.469 | II |
| 10-130380-404 | 40 | 1.109 | .984 | 1.546 | 2.312 | 2.3125-16UN | 1.500 | 3.121 | 2.562 | 5.115 | 2.125 | II |
| 10-130380-441 | 44 | 1.900 | 1.775 | 2.438 | 2.750 | 2.625-16UN | 1.625 | 4.281 | 2.875 | 6.588 | 3.171 | II |

*For complete order number see pages 4 and 5.

QWL – accessories

10-10133X

cable sealing adapter

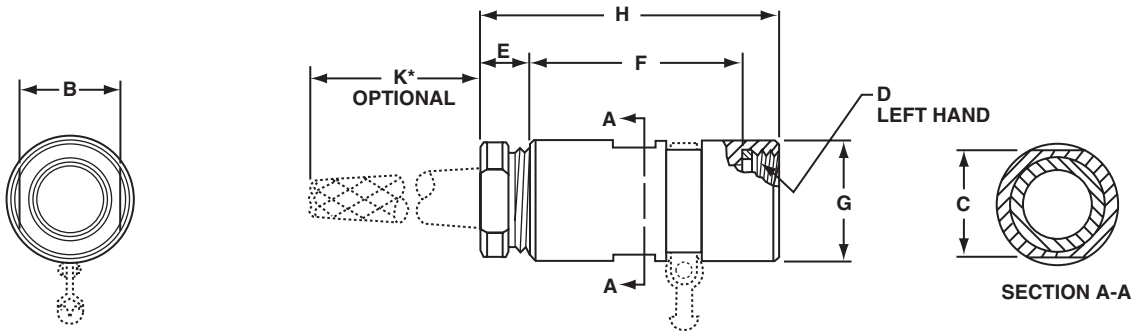

Type I Straight

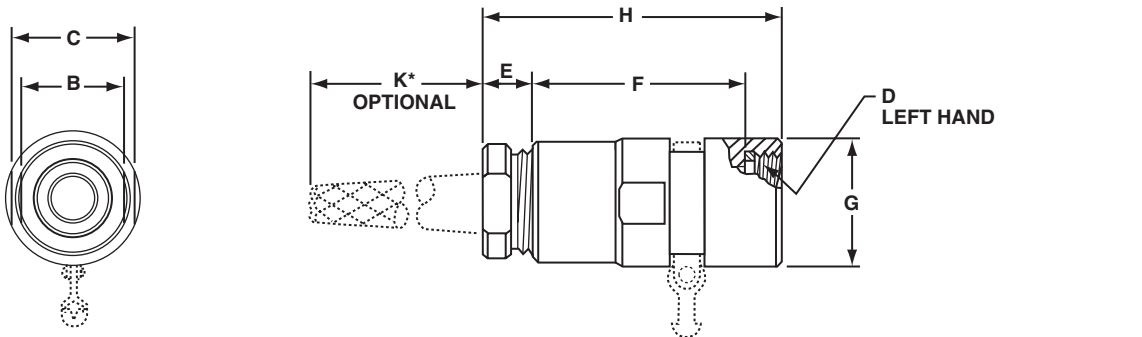

Type II Step Down

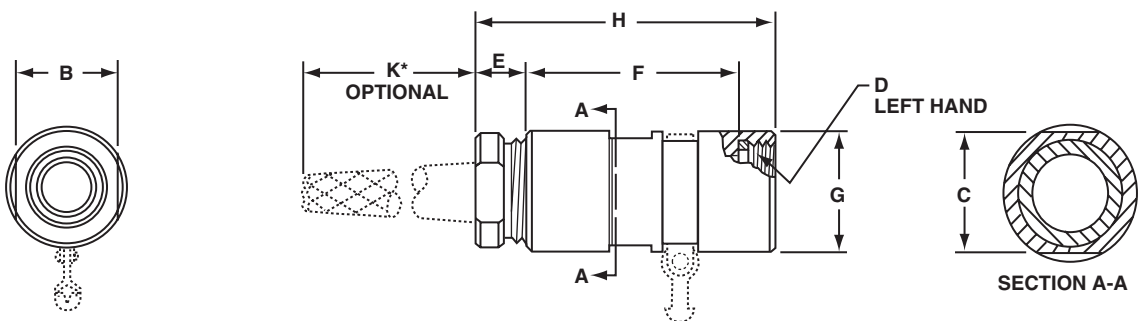

Type III Step Up

*Wire grip dimensions (K) apply to 10-101332 and 10-101334 assemblies only.

QWL – accessories

10-10133X

cable sealing adapter

All dimensions are for reference only.

| Part Number* | Used With Shell Size | Cable Range | | B +.000 -.010 | C +.010 -.000 | D Thread Class 2B-LH | E Free Max. | F +.010 -.020 | G Dia. +.010 -.020 | H ±.045 | K Free Approx. | Type |
|---------------|----------------------|-------------|-----------|---------------------|---------------------|-------------------------|-------------------|---------------------|-----------------------------|------------|----------------------|------|
| | | Max. Dia. | Min. Dia. | | | | | | | | | |
| 10-10133X-121 | 12S | .281 | .219 | .750 | .812 | .6250-24NEF | .500 | 1.938 | .812 | 2.750 | 2.844 | III |
| 10-10133X-122 | 12S | .500 | .406 | 1.062 | 1.000 | .6250-24NEF | .562 | 2.875 | .812 | 3.750 | 4.688 | III |
| 10-10133X-123 | 12S | .405 | .316 | 1.000 | .812 | .6250-24NEF | .562 | 2.548 | .812 | 3.422 | 3.688 | III |
| 10-10133X-141 | 14S | .337 | .281 | .750 | .812 | .7500-20UNEF | .500 | 1.782 | .938 | 2.594 | 3.344 | I |
| 10-10133X-142 | 14S | .222 | .160 | .625 | .812 | .7500-20UNEF | .562 | 1.782 | .938 | 2.532 | 2.406 | II |
| 10-10133X-143 | 14S | .281 | .219 | .750 | .812 | .7500-20UNEF | .500 | 1.782 | .938 | 2.594 | 2.844 | I |
| 10-10133X-144 | 14S | .530 | .441 | 1.000 | .812 | .7500-20UNEF | .562 | 2.719 | .938 | 3.594 | 4.688 | III |
| 10-10133X-145 | 14S | .463 | .406 | .875 | .938 | .7500-20UNEF | .500 | 2.126 | .938 | 2.938 | 4.344 | III |
| 10-10133X-146 | 14S | .405 | .316 | 1.000 | .812 | .7500-20UNEF | .562 | 2.719 | .938 | 3.594 | 3.688 | III |
| 10-10133X-151 | 14 | .405 | .316 | 1.000 | .812 | .7500-20UNEF | .562 | 2.719 | .938 | 3.765 | 3.688 | III |
| 10-10133X-161 | 16S | .463 | .406 | .875 | .938 | .8750-20UNEF | .500 | 1.844 | 1.062 | 2.656 | 4.344 | I |
| 10-10133X-162 | 16S | .589 | .511 | 1.000 | 1.062 | .8750-20UNEF | .562 | 2.282 | 1.062 | 3.156 | 5.188 | III |
| 10-10133X-163 | 16S | .625 | .580 | 1.062 | 1.125 | .8750-20UNEF | .562 | 2.933 | 1.062 | 3.807 | 6.188 | III |
| 10-10133X-164 | 16S | .405 | .316 | 1.000 | 1.062 | .8750-20UNEF | .562 | 2.282 | 1.062 | 3.156 | 3.688 | III |
| 10-10133X-165 | 16S | .530 | .441 | 1.000 | 1.062 | .8750-20UNEF | .562 | 2.282 | 1.062 | 3.156 | 4.688 | III |
| 10-10133X-166 | 16S | .699 | .605 | 1.062 | 1.125 | .8750-20UNEF | .562 | 2.933 | 1.062 | 3.807 | 6.188 | III |
| 10-10133X-167 | 16S | .281 | .219 | .750 | .938 | .8750-20UNEF | .500 | 1.844 | 1.062 | 2.656 | 2.844 | II |
| 10-10133X-171 | 16 | .589 | .511 | 1.000 | 1.062 | .8750-20UNEF | .562 | 2.621 | 1.062 | 3.667 | 5.188 | III |
| 10-10133X-172 | 16 | .438 | .400 | .875 | .938 | .8750-20UNEF | .500 | 2.215 | 1.062 | 3.199 | 4.344 | I |
| 10-10133X-173 | 16 | .625 | .580 | 1.062 | 1.125 | .8750-20UNEF | .562 | 2.933 | 1.062 | 3.979 | 6.188 | III |
| 10-10133X-174 | 16 | .530 | .441 | 1.000 | 1.062 | .8750-20UNEF | .562 | 2.621 | 1.062 | 3.667 | 4.688 | III |
| 10-10133X-175 | 16 | .405 | .316 | 1.000 | 1.062 | .8750-20UNEF | .562 | 2.621 | 1.062 | 3.667 | 3.688 | III |
| 10-10133X-181 | 18 | .589 | .511 | 1.000 | 1.062 | 1.0000-20UNEF | .562 | 2.621 | 1.188 | 3.667 | 5.188 | I |
| 10-10133X-182 | 18 | .625 | .580 | 1.062 | 1.125 | 1.0000-20UNEF | .562 | 2.933 | 1.188 | 3.979 | 6.188 | III |
| 10-10133X-183 | 18 | .530 | .441 | 1.000 | 1.062 | 1.0000-20UNEF | .562 | 2.621 | 1.188 | 3.667 | 4.688 | I |
| 10-10133X-184 | 18 | .699 | .605 | 1.062 | 1.125 | 1.0000-20UNEF | .562 | 2.933 | 1.188 | 3.979 | 6.188 | III |
| 10-10133X-185 | 18 | .405 | .316 | 1.000 | 1.062 | 1.0000-20UNEF | .562 | 2.621 | 1.188 | 3.667 | 3.688 | I |
| 10-10133X-186 | 18 | .455 | .361 | 1.062 | 1.125 | 1.0000-20UNEF | .562 | 2.933 | 1.188 | 3.979 | 4.188 | III |
| 10-10133X-187 | 18 | .750 | .637 | 1.250 | 1.000 | 1.0000-20UNEF | .562 | 3.063 | 1.188 | 4.109 | 6.688 | III |
| 10-10133X-188 | 18 | .172 | .078 | .750 | .938 | 1.0000-20UNEF | .500 | 2.407 | 1.188 | 3.391 | 2.844 | II |
| 10-10133X-190 | 18 | .805 | .692 | 1.250 | 1.000 | 1.0000-20UNEF | .562 | 3.063 | 1.188 | 4.109 | 6.688 | III |
| 10-10133X-201 | 20 | .625 | .580 | 1.062 | 1.125 | 1.1250-18NEF | .562 | 2.933 | 1.312 | 3.979 | 6.188 | I |
| 10-10133X-202 | 20 | .699 | .605 | 1.062 | 1.125 | 1.1250-18NEF | .562 | 2.933 | 1.312 | 3.979 | 6.188 | I |
| 10-10133X-203 | 20 | .500 | .406 | 1.062 | 1.125 | 1.1250-18NEF | .562 | 2.933 | 1.312 | 3.979 | 4.688 | I |
| 10-10133X-204 | 20 | .337 | .281 | .750 | 1.125 | 1.1250-18NEF | .500 | 2.438 | 1.312 | 3.422 | 3.344 | II |
| 10-10133X-205 | 20 | .828 | .715 | 1.125 | 1.250 | 1.1250-18NEF | .547 | 2.996 | 1.312 | 4.042 | 6.688 | III |
| 10-10133X-206 | 20 | .375 | .312 | .875 | 1.125 | 1.1250-18NEF | .500 | 2.469 | 1.312 | 3.453 | 3.844 | II |
| 10-10133X-207 | 20 | .281 | .219 | .750 | 1.125 | 1.1250-18NEF | .500 | 2.438 | 1.312 | 3.422 | 2.844 | II |
| 10-10133X-208 | 20 | .455 | .361 | 1.062 | 1.125 | 1.1250-18NEF | .562 | 2.933 | 1.312 | 3.979 | 4.188 | I |
| 10-10133X-209 | 20 | .589 | .511 | 1.000 | 1.125 | 1.1250-18NEF | .562 | 2.621 | 1.312 | 3.667 | 5.188 | II |
| 10-10133X-210 | 20 | .530 | .441 | 1.000 | 1.125 | 1.1250-18NEF | .562 | 2.621 | 1.312 | 3.667 | 4.688 | II |
| 10-10133X-211 | 20 | .900 | .791 | 1.250 | 1.250 | 1.1250-18NEF | .562 | 3.063 | 1.312 | 4.109 | 7.188 | III |

*For complete order number see pages 4 and 5.

QWL – accessories

10-10133X

cable sealing adapter

All dimensions are for reference only.

| Part Number* | Used With Shell Size | Cable Range | | B +.000 -.010 | C +.000 -.010 | D Thread Class 2B-LH | E Free ±.010 | F +.010 -.020 | G Dia. +.010 -.020 | H ±.045 | K Free Approx. | Type |
|---------------|----------------------|----------------|--------------|---------------------|---------------------|-------------------------|--------------------|---------------------|-----------------------------|------------|----------------------|------|
| | | Max. Dia. | Min. Dia. | | | | | | | | | |
| 10-10133X-221 | 22 | .699 | .605 | 1.062 | 1.250 | 1.2500-18NEF | .562 | 2.933 | 1.438 | 3.979 | 6.188 | II |
| 10-10133X-222 | 22 | .750 | .637 | 1.250 | 1.375 | 1.2500-18NEF | .562 | 3.059 | 1.438 | 4.105 | 6.688 | III |
| 10-10133X-223 | 22 | .445 | .367 | 1.062 | 1.250 | 1.2500-18NEF | .562 | 2.933 | 1.438 | 3.979 | 4.188 | II |
| 10-10133X-224 | 22 | 1.000 | .875 | 1.500 | 1.375 | 1.2500-18NEF | .562 | 3.121 | 1.438 | 4.167 | 7.188 | III |
| 10-10133X-225 | 22 | .828 | .715 | 1.125 | 1.250 | 1.2500-18NEF | .594 | 2.996 | 1.438 | 4.072 | 6.688 | I |
| 10-10133X-226 | 22 | .900 | .791 | 1.250 | 1.375 | 1.2500-18NEF | .562 | 3.059 | 1.438 | 4.105 | 7.188 | III |
| 10-10133X-227 | 22 | .562 | .453 | 1.125 | 1.250 | 1.2500-18NEF | .594 | 2.996 | 1.438 | 4.074 | 5.188 | I |
| 10-10133X-228 | 22 | 1.101 | .984 | 1.500 | 1.375 | 1.2500-18NEF | .562 | 3.121 | 1.438 | 4.167 | 7.688 | III |
| 10-10133X-229 | 22 | .589 | .511 | 1.000 | 1.250 | 1.2500-18NEF | .562 | 2.750 | 1.438 | 3.796 | 5.188 | II |
| 10-10133X-231 | 22 | 1.055 | .958 | 1.500 | 1.375 | 1.2500-18NEF | .562 | 3.121 | 1.438 | 4.167 | 7.688 | III |
| 10-10133X-241 | 24 | 1.000 | .875 | 1.500 | 1.625 | 1.3750-18NEF | .562 | 3.121 | 1.562 | 4.167 | 7.188 | III |
| 10-10133X-242 | 24 | .562 | .453 | 1.125 | 1.406 | 1.3750-18NEF | .562 | 2.996 | 1.562 | 4.042 | 5.188 | II |
| 10-10133X-243 | 24 | .750 | .637 | 1.250 | 1.375 | 1.3750-18NEF | .562 | 3.059 | 1.562 | 4.105 | 6.688 | I |
| 10-10133X-244 | 24 | .900 | .791 | 1.250 | 1.375 | 1.3750-18NEF | .562 | 3.059 | 1.562 | 4.105 | 7.188 | I |
| 10-10133X-245 | 24 | 1.101 | .984 | 1.500 | 1.625 | 1.3750-18NEF | .562 | 3.121 | 1.562 | 4.167 | 7.688 | III |
| 10-10133X-246 | 24 | .405 | .316 | 1.000 | 1.375 | 1.3750-18NEF | .562 | 2.750 | 1.562 | 3.796 | 3.688 | II |
| 10-10133X-247 | 24 | .828 | .715 | 1.125 | 1.406 | 1.3750-18NEF | .562 | 2.996 | 1.562 | 4.042 | 6.688 | II |
| 10-10133X-248 | 24 | .805 | .692 | 1.250 | 1.375 | 1.3750-18NEF | .562 | 3.059 | 1.562 | 4.105 | 6.688 | I |
| 10-10133X-249 | 24 | 1.130 | 1.005 | 1.750 | 1.812 | 1.3750-18NEF | .562 | 3.204 | 1.562 | 4.250 | 7.188 | III |
| 10-10133X-281 | 28 | 1.055 | .958 | 1.500 | 1.625 | 1.6250-18NEF | .562 | 3.121 | 1.812 | 4.167 | 7.688 | I |
| 10-10133X-282 | 28 | .900 | .791 | 1.250 | 1.625 | 1.6250-18NEF | .562 | 3.059 | 1.812 | 4.105 | 7.188 | II |
| 10-10133X-283 | 28 | 1.000 | .875 | 1.500 | 1.625 | 1.6250-18NEF | .562 | 3.121 | 1.812 | 4.167 | 7.188 | I |
| 10-10133X-284 | 28 | .630 | .535 | 1.250 | 1.625 | 1.6250-18NEF | .562 | 3.059 | 1.812 | 4.105 | 5.688 | II |
| 10-10133X-285 | 28 | .750 | .637 | 1.250 | 1.625 | 1.6250-18NEF | .562 | 3.059 | 1.812 | 4.105 | 6.688 | II |
| 10-10133X-286 | 28 | 1.180 | 1.099 | 1.750 | 1.875 | 1.6250-18NEF | .562 | 3.184 | 1.812 | 4.230 | 8.188 | III |
| 10-10133X-287 | 28 | 1.101 | .984 | 1.500 | 1.625 | 1.6250-18NEF | .562 | 3.121 | 1.812 | 4.167 | 7.688 | I |
| 10-10133X-288 | 28 | 1.310 | 1.200 | 1.750 | 1.875 | 1.6250-18NEF | .562 | 3.184 | 1.812 | 4.230 | 8.688 | III |
| 10-10133X-289 | 28 | 1.230 | 1.105 | 1.750 | 1.875 | 1.6250-18NEF | .562 | 3.184 | 1.812 | 4.230 | 8.188 | III |
| 10-10133X-290 | 28 | .880 | .755 | 1.500 | 1.625 | 1.6250-18NEF | .562 | 3.121 | 1.812 | 4.167 | 6.688 | I |
| 10-10133X-291 | 28 | .957 | .857 | 1.250 | 1.625 | 1.6250-18NEF | .547 | 3.059 | 1.812 | 4.090 | 7.188 | II |
| 10-10133X-292 | 28 | .828 | .715 | 1.125 | 1.625 | 1.6250-18NEF | .562 | 2.954 | 1.812 | 4.000 | 6.688 | II |
| 10-10133X-293 | 28 | 1.375 | 1.250 | 2.000 | 1.875 | 1.6250-18NEF | .562 | 3.184 | 1.812 | 4.230 | 9.688 | III |
| 10-10133X-294 | 28 | 1.445 | 1.320 | 2.000 | 1.875 | 1.6250-18NEF | .562 | 3.184 | 1.812 | 4.230 | 9.688 | III |
| 10-10133X-295 | 28 | .805 | .692 | 1.250 | 1.625 | 1.6250-18NEF | .562 | 3.059 | 1.812 | 4.105 | 6.688 | II |
| 10-10133X-321 | 32 | .880 | .755 | 1.500 | 1.875 | 1.8750-16N | .562 | 3.121 | 2.062 | 4.167 | 6.688 | II |
| 10-10133X-322 | 32 | 1.101 | .984 | 1.500 | 1.875 | 1.8750-16N | .562 | 3.121 | 2.062 | 4.167 | 7.688 | II |
| 10-10133X-323 | 32 | .750 | .637 | 1.250 | 1.875 | 1.8750-16N | .562 | 3.059 | 2.062 | 4.105 | 6.688 | II |
| 10-10133X-324 | 32 | 1.445 | 1.320 | 2.000 | 2.062 | 1.8750-16N | .672 | 3.246 | 2.062 | 4.292 | 9.688 | III |
| 10-10133X-325 | 32 | 1.180 | 1.099 | 1.750 | 1.875 | 1.8750-16N | .562 | 3.184 | 2.062 | 4.230 | 8.188 | I |
| 10-10133X-326 | 32 | .375 | .312 | .875 | 1.875 | 1.8750-16N | .500 | 2.766 | 2.062 | 3.750 | 3.844 | II |
| 10-10133X-327 | 32 | .957 | .857 | 1.250 | 1.875 | 1.8750-16N | .562 | 3.059 | 2.062 | 4.105 | 7.188 | II |
| 10-10133X-328 | 32 | 1.230 | 1.105 | 1.750 | 1.875 | 1.8750-16N | .562 | 3.184 | 2.062 | 4.230 | 8.188 | I |
| 10-10133X-329 | 32 | 1.530 | 1.406 | 2.000 | 2.062 | 1.8750-16N | .562 | 3.246 | 2.062 | 4.292 | 10.688 | III |
| 10-10133X-330 | 32 | 1.000 | .875 | 1.500 | 1.875 | 1.8750-16N | .562 | 3.121 | 2.062 | 4.167 | 7.188 | II |
| 10-10133X-331 | 32 | 1.375 | 1.250 | 2.000 | 2.062 | 1.8750-16N | .562 | 3.246 | 2.062 | 4.292 | 9.688 | III |
| 10-10133X-332 | 32 | 1.310 | 1.200 | 1.750 | 1.875 | 1.8750-16N | .562 | 3.184 | 2.062 | 4.230 | 8.688 | I |
| 10-10133X-333 | 32 | .580 x .825 | (Oval) | 1.500 | 1.875 | 1.8750-16N | .562 | 3.121 | 2.062 | 4.167 | 6.688 | II |
| 10-10133X-334 | 32 | .500 x .705 | (Oval) | 1.500 | 1.875 | 1.8750-16N | .562 | 3.121 | 2.062 | 4.167 | 6.688 | II |

*For complete order number see pages 4 and 5.

QWL – accessories

10-10133X

cable sealing adapter

All dimensions are for reference only.

| Part Number* | Used With Shell Size | Cable Range | | B +.000 -.010 | C +.000 -.010 | D Thread Class 2B-LH | E Free ±.035 | F +.010 -.020 | G Dia. +.010 -.020 | H ±.045 | K Free Approx. | Type |
|---------------|----------------------|--------------|--------------|---------------------|---------------------|-------------------------|--------------------|---------------------|-----------------------------|------------|----------------------|------|
| | | Max. Dia. | Min. Dia. | | | | | | | | | |
| 10-10133X-335 | 32 | .530 | .441 | 1.000 | 1.625 | 1.8750-16N | .562 | 2.875 | 2.062 | 3.921 | 4.688 | II |
| 10-10133X-336 | 32 | .680 | .567 | 1.250 | 1.875 | 1.8750-16N | .562 | 3.059 | 2.062 | 4.105 | 6.688 | II |
| 10-10133X-337 | 32 | .463 | .406 | .875 | 1.875 | 1.8750-16N | .500 | 2.766 | 2.062 | 3.750 | 4.344 | II |
| 10-10133X-361 | 36 | 1.055 | .958 | 1.500 | 2.062 | 2.0625-16N | .562 | 3.121 | 2.312 | 4.167 | 7.688 | II |
| 10-10133X-362 | 36 | 1.445 | 1.320 | 2.000 | 2.062 | 2.0625-16N | .562 | 3.246 | 2.312 | 4.292 | 9.688 | I |
| 10-10133X-363 | 36 | 1.530 | 1.406 | 2.000 | 2.062 | 2.0625-16N | .562 | 3.246 | 2.312 | 4.292 | 10.688 | I |
| 10-10133X-364 | 36 | 1.230 | 1.105 | 1.750 | 2.062 | 2.0625-16N | .562 | 3.184 | 2.312 | 4.230 | 8.188 | II |
| 10-10133X-365 | 36 | .750 | .637 | 1.250 | 2.062 | 2.0625-16N | .562 | 3.059 | 2.312 | 4.105 | 6.688 | II |
| 10-10133X-366 | 36 | .880 | .755 | 1.500 | 2.062 | 2.0625-16N | .562 | 3.121 | 2.312 | 4.167 | 6.688 | II |
| 10-10133X-367 | 36 | 1.656 | 1.531 | 2.250 | 2.312 | 2.0625-16N | .562 | 3.308 | 2.312 | 4.354 | 12.688 | III |
| 10-10133X-368 | 36 | 1.101 | .984 | 1.500 | 2.062 | 2.0625-16N | .562 | 3.121 | 2.312 | 4.167 | 7.688 | II |
| 10-10133X-369 | 36 | .957 | .857 | 1.250 | 2.062 | 2.0625-16N | .672 | 3.059 | 2.312 | 4.090 | 7.188 | II |
| 10-10133X-370 | 36 | 1.900 | 1.775 | 2.438 | 2.312 | 2.0625-16N | .500 | 3.500 | 2.312 | 4.656 | 13.688 | III |
| 10-10133X-371 | 36 | .375 | .312 | .875 | 2.062 | 2.0625-16N | .500 | 2.813 | 2.312 | 3.797 | 3.844 | II |
| 10-10133X-372 | 36 | 1.825 | 1.700 | 2.438 | 2.312 | 2.0625-16N | .672 | 3.500 | 2.312 | 4.656 | 13.688 | III |
| 10-10133X-373 | 36 | 1.375 | 1.250 | 2.000 | 2.062 | 2.0625-16N | .562 | 3.246 | 2.312 | 4.292 | 9.688 | I |
| 10-10133X-374 | 36 | 1.562 | 1.437 | 2.250 | 2.312 | 2.0625-16N | .562 | 3.308 | 2.312 | 4.354 | 11.188 | III |
| 10-10133X-375 | 36 | 1.730 | 1.605 | 2.438 | 2.312 | 2.0625-16N | .672 | 3.500 | 2.312 | 4.656 | 13.688 | III |
| 10-10133X-376 | 36 | .530 | .441 | 1.000 | 1.875 | 2.0625-16N | .562 | 2.875 | 2.312 | 3.921 | 4.688 | II |
| 10-10133X-377 | 36 | 1.130 | 1.005 | 1.750 | 2.062 | 2.0625-16N | .562 | 3.184 | 2.312 | 4.230 | 7.188 | II |
| 10-10133X-378 | 36 | 1.180 | 1.055 | 1.750 | 2.062 | 2.0625-16N | .562 | 3.184 | 2.312 | 4.230 | 8.188 | II |
| 10-10133X-379 | 36 | 1.595 | 1.470 | 2.250 | 2.312 | 2.0625-16N | .562 | 3.308 | 2.312 | 4.354 | 11.688 | III |
| 10-10133X-401 | 40 | 1.310 | 1.200 | 1.750 | 2.312 | 2.3125-16N | .562 | 3.184 | 2.562 | 4.230 | 8.688 | II |
| 10-10133X-402 | 40 | 1.656 | 1.531 | 2.250 | 2.312 | 2.3125-16N | .562 | 3.308 | 2.562 | 4.354 | 12.688 | I |
| 10-10133X-403 | 40 | 1.101 | .984 | 1.500 | 2.312 | 2.3125-16N | .438 | 3.121 | 2.562 | 4.167 | 7.688 | II |
| 10-10133X-404 | 40 | 1.562 | 1.437 | 2.250 | 2.312 | 2.3125-16N | .562 | 3.308 | 2.562 | 4.354 | 11.188 | I |
| 10-10133X-405 | 40 | 1.375 | 1.250 | 2.000 | 2.312 | 2.3125-16N | .562 | 3.246 | 2.562 | 4.292 | 9.688 | II |
| 10-10133X-406 | 40 | 1.180 | 1.099 | 1.750 | 2.312 | 2.3125-16N | .562 | 3.184 | 2.562 | 4.230 | 8.188 | II |
| 10-10133X-407 | 40 | 1.900 | 1.775 | 2.438 | 2.500 | 2.3125-16N | .672 | 3.469 | 2.562 | 4.625 | 13.688 | III |
| 10-10133X-408 | 40 | 1.730 | 1.605 | 2.438 | 2.500 | 2.3125-16N | .672 | 3.469 | 2.562 | 4.625 | 13.688 | III |
| 10-10133X-409 | 40 | 1.825 | 1.700 | 2.438 | 2.500 | 2.3125-16N | .672 | 3.469 | 2.562 | 4.625 | 13.688 | III |
| 10-10133X-410 | 40 | 1.984 | 1.859 | 2.438 | 2.500 | 2.3125-16N | .672 | 3.469 | 2.562 | 4.625 | 13.688 | III |
| 10-10133X-411 | 40 | 1.445 | 1.320 | 2.000 | 2.312 | 2.3125-16N | .562 | 3.246 | 2.562 | 4.292 | 9.688 | II |
| 10-10133X-412 | 40 | 2.062 | 1.937 | 2.750 | 2.500 | 2.3125-16N | .672 | 3.500 | 2.562 | 4.656 | 14.188 | III |
| 10-10133X-413 | 40 | 2.100 | 1.955 | 2.750 | 2.500 | 2.3125-16N | .672 | 3.500 | 2.562 | 4.656 | 14.188 | III |
| 10-10133X-414 | 40 | 2.145 | 2.000 | 2.750 | 2.500 | 2.3125-16N | .672 | 3.500 | 2.562 | 4.656 | 14.188 | III |
| 10-10133X-415 | 40 | .957 | .857 | 1.250 | 2.125 | 2.3125-16N | .562 | 3.063 | 2.562 | 4.109 | 7.188 | II |
| 10-10133X-416 | 40 | 1.230 | 1.103 | 1.750 | 2.312 | 2.3125-16N | .562 | 3.184 | 2.562 | 4.230 | 8.188 | II |
| 10-10133X-417 | 40 | 1.055 | .958 | 1.500 | 2.312 | 2.3125-16N | .562 | 3.121 | 2.562 | 4.167 | 7.688 | II |
| 10-10133X-418 | 40 | .630 | .567 | 1.250 | 2.250 | 2.3125-16UN | .562 | 3.063 | 2.562 | 4.109 | 6.688 | II |
| 10-10133X-441 | 44 | 2.170 | 2.025 | 2.750 | 2.625 | 2.6250-16UN | .672 | 3.609 | 2.875 | 4.953 | 17.188 | III |
| 10-10133X-442 | 44 | 2.145 | 2.000 | 2.750 | 2.625 | 2.6250-16UN | .672 | 3.547 | 2.875 | 4.891 | 14.188 | III |
| 10-10133X-443 | 44 | 2.250 | 2.105 | 2.750 | 2.625 | 2.6250-16UN | .672 | 3.609 | 2.875 | 4.953 | 17.188 | III |
| 10-10133X-445 | 44 | 1.130 | 1.005 | 1.750 | 2.625 | 2.6250-16UN | .562 | 3.969 | 2.875 | 5.203 | 7.188 | II |
| 10-10133X-446 | 44 | 1.109 | .984 | 1.500 | 2.500 | 2.6250-16UN | .562 | 3.905 | 2.875 | 5.140 | 7.688 | II |
| 10-10133X-449 | 44 | 1.445 | 1.320 | 2.000 | 2.562 | 2.6250-16UN | .562 | 4.031 | 2.875 | 5.265 | 9.688 | II |
| 10-10133X-481 | 48 | 1.900 | 1.775 | 2.438 | 2.812 | 2.8750-16N | .562 | 3.203 | 3.125 | 4.547 | 13.688 | II |
| 10-10133X-482 | 48 | 2.000 | 1.867 | 2.750 | 2.969 | 2.8750-16N | .672 | 4.281 | 3.125 | 5.625 | 14.188 | II |
| 10-10133X-483 | 48 | 2.250 | 2.105 | 2.750 | 2.750 | 2.8750-16N | .672 | 4.406 | 3.125 | 5.750 | 17.188 | I |
| 10-10133X-484 | 48 | 2.170 | 2.025 | 2.750 | 2.750 | 2.8750-16N | .672 | 4.406 | 3.125 | 5.750 | 17.188 | I |

*For complete order number see pages 4 and 5.

QWL – accessories

10-113637

cable sealing adapter (with woven strain relief)



QWL – accessories

10-113637

cable sealing adapter (with woven strain relief)

All dimensions are for reference only.

| Part Number* | Used With Shell Size | Cable Range | | B +.000 -.010 | C +.010 -.000 | D Thread Class 2B-LH | E Free ±.035 | F +.010 -.020 | G Dia. +.010 -.020 | H ±.045 | K Free Approx. | Type |
|---------------|----------------------|-------------|-----------|---------------------|---------------------|-------------------------|--------------------|---------------------|-----------------------------|------------|----------------------|------|
| | | Max. Dia. | Min. Dia. | | | | | | | | | |
| 10-113637-141 | 14S | .337 | .281 | .750 | .750 | .7500-20UNEF | .500 | 5.282 | .938 | 6.094 | 3.344 | I |
| 10-113637-142 | 14S | .405 | .316 | 1.000 | 1.000 | .7500-20UNEF | .562 | 5.500 | .938 | 6.374 | 3.688 | III |
| 10-113637-143 | 14S | .530 | .441 | 1.000 | 1.000 | .7500-20UNEF | .562 | 5.500 | .938 | 6.374 | 4.688 | III |
| 10-113637-144 | 14S | .463 | .406 | .875 | .938 | .7500-20UNEF | .500 | 5.344 | .938 | 6.156 | 4.344 | III |
| 10-113637-171 | 16 | .699 | .605 | 1.062 | 1.125 | .8750-20UNEF | .562 | 5.563 | 1.062 | 6.609 | 6.188 | III |
| 10-113637-172 | 16 | .530 | .441 | 1.000 | 1.000 | .8750-20UNEF | .562 | 5.500 | 1.062 | 6.546 | 4.688 | III |
| 10-113637-181 | 18 | .828 | .715 | 1.125 | 1.250 | 1.0000-20UNEF | .562 | 6.657 | 1.188 | 7.703 | 6.688 | III |
| 10-113637-201 | 20 | .750 | .637 | 1.250 | 1.312 | 1.1250-18NEF | .562 | 6.000 | 1.312 | 7.046 | 6.688 | III |
| 10-113637-202 | 20 | .984 | .875 | 1.500 | 1.625 | 1.1250-18NEF | .562 | 6.750 | 1.312 | 7.796 | 7.188 | III |
| 10-113637-203 | 20 | .900 | .791 | 1.250 | 1.312 | 1.1250-18UNEF | .562 | 6.000 | 1.312 | 7.046 | 7.188 | III |
| 10-113637-221 | 22 | .750 | .637 | 1.250 | 1.312 | 1.2500-18NEF | .562 | 6.000 | 1.438 | 7.046 | 6.688 | III |
| 10-113637-222 | 22 | .699 | .605 | 1.062 | 1.312 | 1.2500-18NEF | .562 | 5.063 | 1.438 | 6.109 | 6.188 | II |
| 10-113637-223 | 22 | 1.055 | .958 | 1.500 | 1.625 | 1.2500-18NEF | .562 | 6.750 | 1.438 | 7.796 | 7.688 | III |
| 10-113637-224 | 22 | 1.828 | .715 | 1.125 | 1.250 | 1.2500-18NEF | .562 | 5.625 | 1.438 | 6.671 | 6.688 | I |
| 10-113637-225 | 22 | .589 | .511 | 1.000 | 1.250 | 1.2500-18NEF | .562 | 5.500 | 1.438 | 6.546 | 5.188 | II |
| 10-113637-241 | 24 | .957 | .857 | 1.250 | 1.375 | 1.3750-18NEF | .562 | 6.000 | 1.562 | 7.046 | 7.188 | I |
| 10-113637-242 | 24 | .750 | .637 | 1.250 | 1.375 | 1.3750-18NEF | .562 | 6.000 | 1.562 | 7.046 | 6.688 | I |
| 10-113637-243 | 24 | 1.101 | .984 | 1.500 | 1.625 | 1.3750-18NEF | .562 | 6.750 | 1.562 | 7.796 | 7.688 | III |
| 10-113637-244 | 24 | 1.000 | .875 | 1.500 | 1.625 | 1.3750-18NEF | .562 | 6.750 | 1.562 | 7.796 | 7.188 | III |
| 10-113637-245 | 24 | 1.180 | 1.055 | 1.750 | 1.812 | 1.3750-18NEF | .562 | 6.813 | 1.562 | 7.859 | 8.188 | III |
| 10-113637-246 | 24 | .805 | .692 | 1.250 | 1.375 | 1.3750-18NEF | .562 | 6.000 | 1.562 | 7.046 | 6.688 | I |
| 10-113637-281 | 28 | 1.000 | .875 | 1.500 | 1.562 | 1.6250-18NEF | .562 | 6.750 | 1.812 | 7.796 | 7.188 | I |
| 10-113637-282 | 28 | 1.900 | 1.775 | 2.438 | 2.438 | 1.6250-18NEF | .672 | 8.125 | 1.812 | 9.281 | 13.688 | III |
| 10-113637-283 | 28 | 1.375 | 1.250 | 2.000 | 2.000 | 1.6250-18NEF | .562 | 6.875 | 1.812 | 7.921 | 9.688 | III |
| 10-113637-284 | 28 | .750 | .637 | 1.250 | 1.562 | 1.6250-18NEF | .562 | 5.750 | 1.812 | 6.796 | 6.688 | II |
| 10-113637-285 | 28 | 1.101 | .984 | 1.500 | 1.562 | 1.6250-18NEF | .562 | 6.750 | 1.812 | 7.796 | 7.688 | I |
| 10-113637-286 | 28 | 1.130 | 1.005 | 1.750 | 1.875 | 1.6250-18NEF | .562 | 6.813 | 1.812 | 7.859 | 7.188 | III |
| 10-113637-287 | 28 | .900 | .791 | 1.250 | 1.562 | 1.6250-18NEF | .562 | 5.750 | 1.812 | 6.796 | 7.188 | II |
| 10-113637-288 | 28 | 1.427 | 1.320 | 2.000 | 2.000 | 1.6250-18NEF | .562 | 6.875 | 1.812 | 7.921 | 9.688 | III |
| 10-113637-289 | 28 | 1.180 | 1.099 | 1.750 | 1.875 | 1.6250-18NEF | .562 | 6.812 | 1.812 | 7.858 | 8.188 | III |
| 10-113637-290 | 28 | 1.055 | .958 | 1.500 | 1.562 | 1.6250-18NEF | .562 | 6.750 | 1.812 | 7.796 | 7.688 | I |
| 10-113637-291 | 28 | .957 | .857 | 1.250 | 1.562 | 1.6250-18NEF | .562 | 5.750 | 1.812 | 6.796 | 7.188 | II |
| 10-113637-292 | 28 | 1.310 | 1.200 | 1.750 | 1.875 | 1.6250-18NEF | .562 | 6.813 | 1.812 | 7.859 | 8.688 | III |
| 10-113637-293 | 28 | .530 | .441 | 1.000 | 1.625 | 1.6250-18NEF | .562 | 6.500 | 1.812 | 7.546 | 4.688 | II |
| 10-113637-294 | 28 | 1.230 | 1.105 | 1.750 | 1.875 | 1.6250-18NEF | .562 | 6.813 | 1.812 | 7.859 | 8.188 | III |
| 10-113637-295 | 28 | .630 | .535 | 1.250 | 1.562 | 1.6250-18NEF | .562 | 5.750 | 1.812 | 6.796 | 5.688 | II |

*For complete order number see pages 4 and 5.

QWL – accessories

10-113637

cable sealing adapter (with woven strain relief)

All dimensions are for reference only.

| Part Number* | Used With Shell Size | Cable Range | | B +.000 -.010 | C +.010 -.000 | D Thread Class 2B-LH | E Free ±.035 | F +.010 -.020 | G Dia. +.010 -.020 | H ±.045 | K Free Approx. | Type |
|---------------|----------------------|-----------------------|-----------------------|---------------------|---------------------|-------------------------|--------------------|---------------------|-----------------------------|------------|----------------------|------|
| | | Max. Dia. | Min. Dia. | | | | | | | | | |
| 10-113637-321 | 32 | .828 | .715 | 1.125 | 1.844 | 1.8750-16N | .594 | 7.625 | 2.062 | 8.703 | 6.688 | II |
| 10-113637-322 | 32 | 1.310 | 1.200 | 1.750 | 1.812 | 1.8750-16UN | .562 | 6.812 | 2.062 | 7.858 | 8.688 | I |
| 10-113637-323 | 32 | 1.130 | 1.005 | 1.750 | 1.812 | 1.8750-16UN | .562 | 6.812 | 2.062 | 7.858 | 7.188 | I |
| 10-113637-324 | 32 | 1.375 | 1.250 | 2.000 | 2.000 | 1.8750-16UN | .562 | 7.875 | 2.062 | 8.921 | 9.688 | III |
| 10-113637-325 | 32 | 1.445 | 1.320 | 2.000 | 2.000 | 1.8750-16UN | .562 | 7.875 | 2.062 | 8.921 | 9.688 | III |
| 10-113637-326 | 32 | 1.180 | 1.099 | 1.750 | 1.812 | 1.8750-16UN | .562 | 6.812 | 2.062 | 7.858 | 8.188 | I |
| 10-113637-327 | 32 | 1.656 | 1.531 | 2.250 | 2.250 | 1.8750-16UN | .562 | 7.141 | 2.062 | 8.187 | 12.688 | III |
| 10-113637-328 | 32 | .970 | .857 | 1.250 | 1.844 | 1.8750-16UN | .562 | 6.688 | 2.062 | 7.734 | 7.188 | II |
| 10-113637-361 | 36 | 1.375 | 1.250 | 2.000 | 2.000 | 2.0625-16N | .562 | 6.875 | 2.312 | 7.921 | 9.688 | I |
| 10-113637-362 | 36 | 1.000 | .875 | 1.500 | 2.000 | 2.0625-16N | .562 | 6.750 | 2.312 | 7.796 | 7.188 | II |
| 10-113637-363 | 36 | 1.920 x 1.140 oval | 1.920 x 1.140 oval | 2.438 | 2.438 | 2.0625-16N | .672 | 8.125 | 2.312 | 9.281 | 13.688 | III |
| 10-113637-364 | 36 | 1.230 | 1.105 | 1.750 | 2.000 | 2.0625-16N | .562 | 6.813 | 2.312 | 7.859 | 8.188 | II |
| 10-113637-365 | 36 | 1.562 | 1.437 | 2.250 | 2.250 | 2.0625-16N | .562 | 6.938 | 2.312 | 7.984 | 11.188 | III |
| 10-113637-366 | 36 | 1.656 | 1.531 | 2.250 | 2.250 | 2.0625-16N | .562 | 6.938 | 2.312 | 7.984 | 11.188 | III |
| 10-113637-367 | 36 | 1.445 | 1.320 | 2.000 | 2.000 | 2.0625-16N | .562 | 6.875 | 2.312 | 7.921 | 9.688 | I |
| 10-113637-368 | 36 | 1.825 | 1.700 | 2.438 | 2.500 | 2.0625-16N | .672 | 9.125 | 2.312 | 9.281 | 13.688 | III |
| 10-113637-369 | 36 | 1.895 | 1.775 | 2.438 | 2.438 | 2.0625-16N | .672 | 8.125 | 2.312 | 9.281 | 13.688 | III |
| 10-113637-370 | 36 | 1.730 | 1.605 | 2.438 | 2.438 | 2.0625-16N | .672 | 8.125 | 2.312 | 9.281 | 13.688 | III |
| 10-113637-371 | 36 | 1.310 | 1.200 | 1.750 | 2.000 | 2.0625-16N | .562 | 6.813 | 2.312 | 7.859 | 8.688 | II |
| 10-113637-401 | 40 | 1.906 | 1.761 | 2.750 | 2.438 | 2.3125-16N | .672 | 8.125 | 2.562 | 9.281 | 14.188 | III |
| 10-113637-402 | 40 | 1.940 | 1.815 | 2.438 | 2.438 | 2.3125-16N | .672 | 8.125 | 2.562 | 9.281 | 13.688 | III |
| 10-113637-403 | 40 | 1.900 | 1.775 | 2.438 | 2.438 | 2.3125-16N | .672 | 8.125 | 2.562 | 9.281 | 13.688 | III |
| 10-113637-404 | 40 | 1.825 | 1.700 | 2.438 | 2.438 | 2.3125-16N | .672 | 8.125 | 2.562 | 9.281 | 13.688 | III |
| 10-113637-405 | 40 | 1.310 | 1.200 | 1.750 | 2.250 | 2.3125-16N | .562 | 7.813 | 2.562 | 8.859 | 8.688 | II |
| 10-113637-406 | 40 | 1.180 | 1.099 | 1.750 | 2.250 | 2.3125-16N | .562 | 7.813 | 2.562 | 8.859 | 8.188 | II |
| 10-113637-407 | 40 | 1.230 | 1.105 | 1.750 | 2.250 | 2.3125-16N | .562 | 7.813 | 2.562 | 8.859 | 8.188 | II |
| 10-113637-408 | 40 | 1.656 | 1.531 | 2.250 | 2.250 | 2.3125-16N | .562 | 7.938 | 2.562 | 8.984 | 11.188 | I |
| 10-113637-410 | 40 | 2.145 | 2.000 | 2.750 | 2.438 | 2.3125-16N | .672 | 8.125 | 2.562 | 9.281 | 14.188 | III |
| 10-113637-411 | 40 | 1.984 | 1.859 | 2.438 | 2.438 | 2.3125-16N | .672 | 8.125 | 2.562 | 9.281 | 13.688 | III |
| 10-113637-412 | 40 | 1.940 | 1.815 | 2.438 | 2.438 | 2.3125-16N | .672 | 11.125 | 2.562 | 12.281 | 13.688 | III |
| 10-113637-413 | 40 | 1.984 | 1.859 | 2.438 | 2.438 | 2.3125-16N | .672 | 11.125 | 2.562 | 12.281 | 13.688 | III |
| 10-113637-414 | 40 | 2.100 | 1.955 | 2.750 | 2.625 | 2.3125-16N | .672 | 12.000 | 2.562 | 13.156 | 14.188 | III |
| 10-113637-415 | 40 | 1.562 | 1.437 | 2.250 | 2.250 | 2.3125-16N | .562 | 7.938 | 2.562 | 8.984 | 11.188 | I |
| 10-113637-416 | 40 | 1.445 | 1.320 | 2.000 | 2.312 | 2.3125-16N | .562 | 6.875 | 2.562 | 7.921 | 9.688 | II |
| 10-113637-417 | 40 | 1.375 | 1.250 | 2.000 | 2.312 | 2.3125-16N | .562 | 6.875 | 2.562 | 7.921 | 9.688 | II |

*For complete order number see pages 4 and 5.

QWL – accessories

10-113637

cable sealing adapter (with woven strain relief)

All dimensions are for reference only.

| Part Number* | Used With Shell Size | Cable Range | | B +.000 -.010 | C +.010 -.000 | D Thread Class 2B-LH | E Free ±.035 | F +.010 -.020 | G Dia +.010 -.020 | H ±.045 | K Free† Approx. | Type |
|---------------|----------------------|-------------|---------|---------------------|---------------------|-------------------------|--------------------|---------------------|----------------------------|------------|-----------------------|------|
| | | Max Dia | Min Dia | | | | | | | | | |
| 10-113637-441 | 44 | 2.100 | 1.955 | 2.750 | 2.750 | 2.6250-16UN | .672 | 8.125 | 2.875 | 9.469 | 14.188 | III |
| 10-113637-442 | 44 | 2.250 | 2.105 | 2.750 | 2.875 | 2.6250-16UN | .672 | 8.188 | 2.875 | 9.531 | 17.188 | III |
| 10-113637-443 | 44 | 2.000 | 1.867 | 2.750 | 2.750 | 2.6250-16UN | .672 | 8.125 | 2.875 | 9.469 | 14.188 | III |
| 10-113637-444 | 44 | 1.500 | 1.375 | 2.250 | 2.500 | 2.6250-16UN | .562 | 7.938 | 2.875 | 9.171 | 11.188 | II |
| 10-113637-445 | 44 | 1.730 | 1.605 | 2.438 | 2.750 | 2.6250-16UN | .672 | 8.125 | 2.875 | 9.469 | 13.688 | II |
| 10-113637-446 | 44 | .750 | .637 | 1.250 | 2.625 | 2.6250-16UN | .562 | 6.688 | 2.875 | 7.921 | 6.688 | II |
| 10-113637-447 | 44 | 1.825 | 1.700 | 2.438 | 2.750 | 2.6250-16UN | .672 | 8.125 | 2.875 | 9.469 | 13.688 | II |
| 10-113637-448 | 44 | 2.145 | 2.000 | 2.750 | 2.750 | 2.6250-16UN | .672 | 8.125 | 2.875 | 9.469 | 14.188 | III |
| 10-113637-449 | 44 | 2.170 | 2.025 | 2.750 | 2.875 | 2.6250-16UN | .672 | 8.188 | 2.875 | 9.532 | 17.188 | III |
| 10-113637-450 | 44 | 1.375 | 1.250 | 2.000 | 2.625 | 2.6250-16UN | .562 | 7.875 | 2.875 | 9.109 | 9.688 | II |
| 10-113637-481 | 48 | 2.250 | 2.105 | 2.750 | 2.750 | 2.8750-16N | .672 | 8.188 | 3.125 | 9.532 | 14.688 | I |
| 10-113637-482 | 48 | 2.500 | 2.355 | 2.875 | 2.875 | 2.8750-16N | .672 | 8.188 | 3.125 | 9.532 | 18.188 | III |
| 10-113637-483 | 48 | 2.375 | 2.230 | 2.875 | 2.875 | 2.8750-16N | .672 | 8.188 | 3.125 | 9.532 | 18.188 | III |
| 10-113637-484 | 48 | 2.145 | 2.000 | 2.750 | 2.875 | 2.8750-16N | .672 | 8.125 | 3.125 | 9.469 | 14.188 | II |
| 10-113637-485 | 48 | 2.000 | 1.867 | 2.750 | 2.875 | 2.8750-16N | .672 | 8.125 | 3.125 | 9.469 | 14.188 | II |
| 10-113637-486 | 48 | 1.656 | 1.531 | 2.250 | 2.750 | 2.8750-16UN | .562 | 7.937 | 3.125 | 9.171 | 12.688 | II |

*For complete order number see pages 4 and 5.

QWL – accessories adapter, cable clamp

**10-113196-XX
adapter**

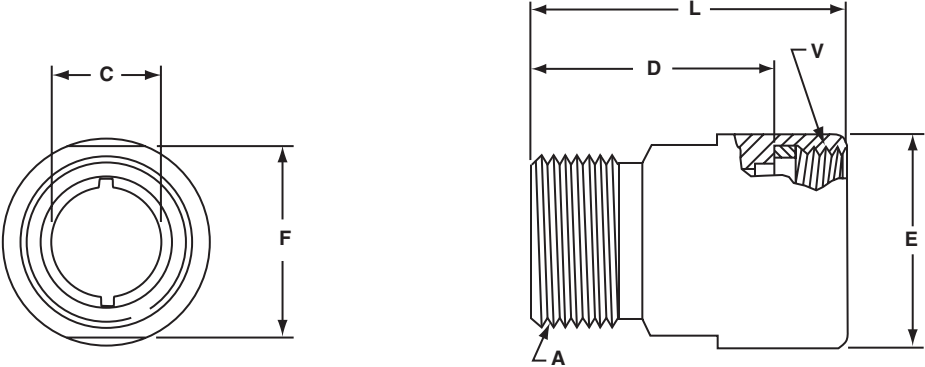

**10-749XX-()
cable clamp**

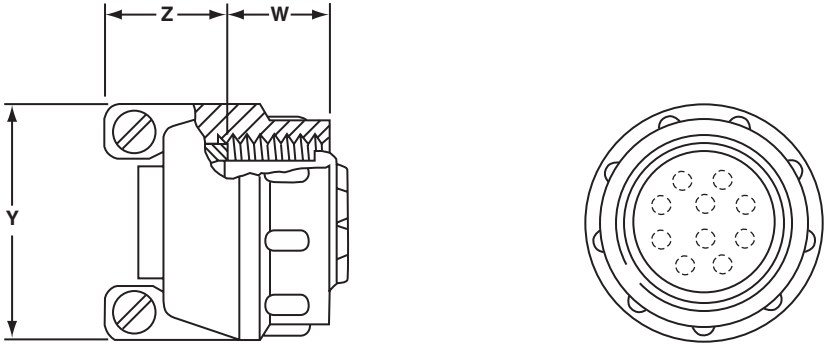

This cable clamp is designed to be used with specific QWL insert arrangements. The locations, quantity, and sizes of holes in the clamp grommet must correspond to those in the connector for an effective moisture seal without wire crossing. Contact Amphenol, Sidney, NY, for grommet availability. Example: 10-107618-4P must use 10-74918-4 clamp.

QWL – accessories

adapter, cable clamp, sealing plugs

All dimensions for reference only.

| Shell Size | Adapter Part Number* | Clamp Part Number* | A Thread Class 2A | C +.010 -.000 | D Dia. +.010 -.020 | E Dia. +.010 -.020 | F ±.010 | L ±.010 | V Thread Class 2B-LH | W Min. Thd. Engage | Y Max. | Z Max. |
|------------|----------------------|--------------------|-------------------|---------------------|--------------------------|--------------------------|------------|------------|----------------------|--------------------|--------|--------|
| 10S | 10-113196-10 | 10-74910-() | .500-28UNEF | .203 | .922 | .625 | .562 | 1.234 | .500-28UNEF | .519 | .807 | .529 |
| 12S | 10-113196-12 | 10-74912-() | .625-24NEF | .328 | .969 | .750 | .688 | 1.281 | .625-24NEF | .519 | .901 | .524 |
| 12 | 10-113196-13 | 10-74913-() | .625-24NEF | .328 | .954 | .750 | .688 | 1.438 | .625-24NEF | .519 | .901 | .524 |
| 14S | 10-113196-14 | 10-74914-() | .750-20UNEF | .453 | 1.094 | .875 | .812 | 1.406 | .750-20UNEF | .519 | 1.026 | .524 |
| 14 | 10-113196-15 | 10-74915-() | .750-20UNEF | .453 | .954 | .875 | .812 | 1.438 | .750-20UNEF | .519 | 1.026 | .524 |
| 16S | 10-113196-16 | 10-74916-() | .875-20UNEF | .578 | 1.094 | 1.000 | .938 | 1.406 | .875-20UNEF | .519 | 1.119 | .524 |
| 16 | 10-113196-17 | 10-74917-() | .875-20UNEF | .578 | 1.016 | 1.000 | .938 | 1.500 | .875-20UNEF | .519 | 1.119 | .524 |
| 18 | 10-113196-18 | 10-74918-() | 1.000-20UNEF | .676 | 1.141 | 1.188 | 1.062 | 1.625 | 1.000-20UNEF | .519 | 1.229 | .556 |
| 20 | 10-113196-20 | 10-74920-() | 1.1875-18NEF | .801 | 1.094 | 1.312 | 1.250 | 1.578 | 1.125-18NEF | .505 | 1.479 | .666 |
| 22 | 10-113196-22 | 10-74922-() | 1.1875-18NEF | .906 | 1.141 | 1.438 | 1.250 | 1.625 | 1.250-18NEF | .519 | 1.479 | .666 |
| 24 | 10-113196-24 | 10-74924-() | 1.4375-18NEF | 1.016 | 1.094 | 1.562 | 1.500 | 1.578 | 1.375-18NEF | .519 | 1.666 | .666 |
| 28 | 10-113196-28 | 10-74928-() | 1.4375-18NEF | 1.130 | 1.235 | 1.812 | 1.500 | 1.719 | 1.625-18NEF | .519 | 1.666 | .666 |
| 32 | 10-113196-32 | 10-74932-() | 1.7500-18NS | 1.438 | 1.204 | 2.062 | 1.875 | 1.688 | 1.875-16N | .519 | 2.135 | .805 |
| 36 | 10-113196-36 | 10-74936-() | 2.000-18NS | 1.678 | 1.266 | 2.250 | 2.125 | 1.750 | 2.0625-16N | .738 | 2.260 | .805 |
| 40 | 10-113196-40 | 10-74940-() | 2.2500-16UN | 1.914 | 1.266 | 2.500 | 2.375 | 1.750 | 2.3125-16N | .738 | 2.510 | .805 |

*For complete order number see page 5. Clamp 10-749XX-() has a bright cadmium finish. An olive drab cadmium plate finish is available by order number 71-749XX-(). To complete clamp order number, add connector insert arrangement number.

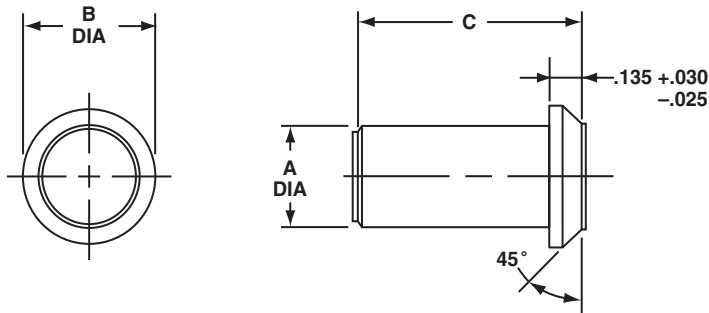

SEALING PLUG MS27488-XX 10-405996-XX

| Order No. | Contact Size | MS Number | Wire Size | Color Code | B ±.005 | C ±.010 | A Dia. ±.010 |
|--------------|--------------|-----------|-----------|------------|------------|------------|-----------------|
| 10-405996-16 | 16 | 27488-16 | 20-16 | Blue | .133 | .564* | .083 |
| 10-405996-12 | 12 | 27488-12 | 14-12 | Yellow | .171 | .564* | .121 |
| 10-405996-8 | 8 | 27488-8 | 10-8 | White | .315 | .470 | .185 |
| 10-405996-4 | 4 | 27488-4 | 4-6 | Blue | .415 | .470 | .310 |
| 10-405996-0 | 0 | 27488-0 | 0-2 | Yellow | .605 | 1.000 | .440 |

*±.020

Sealing plugs are used to fill unused holes in multi-holed grommet configurations

QWL – accessories adapter, cable clamp

10-113138-XX
adapter

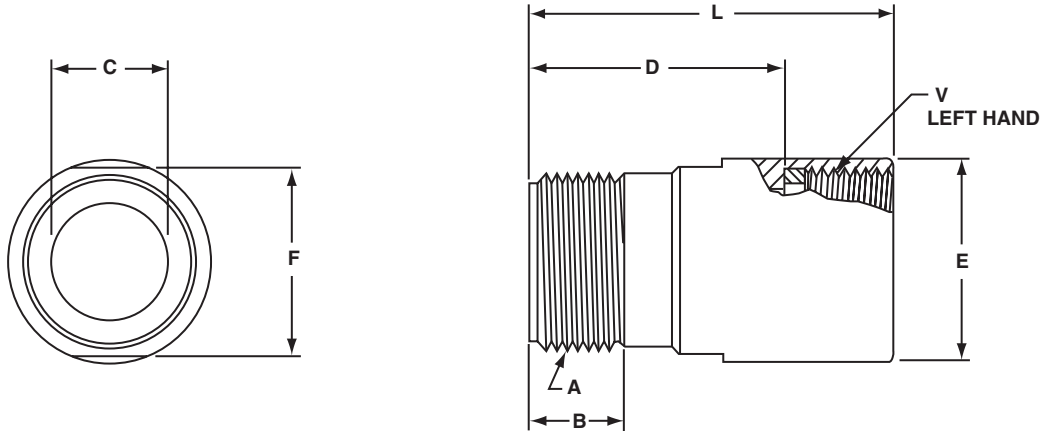

M85049/2-()C
cable clamp

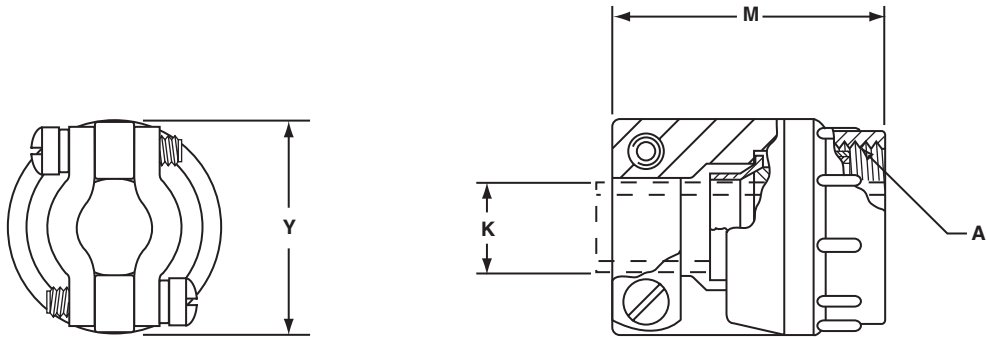

QWL – accessories

adapter, cable clamp, sleeve

| Shell Size | Adapter Part Number* | Clamp MS Part Number* | A Thread Class 2A (Plated) | B Min Full Thd | C Dia +.000 - .010 | D ±.020 | E Dia +.010 - .020 | F ±.010 | K Dia Cable Range | | L Max | M Max | V Thread Class 2B-LH | Y Max |
|------------|----------------------|-----------------------|----------------------------|----------------|--------------------|---------|--------------------|---------|-------------------|--------|-------|-------|----------------------|-------|
| | | | | | | | | | Free | Closed | | | | |
| 12 | 10-113138-12 | M85049/2-4C | .625-24UNEF | .422 | .386 | 1.078 | .750 | .688 | .302 | .094 | 1.390 | 1.375 | .625-24NEF | .906 |
| | 10-113138-13 | M85049/2-4C | .625-24NEF | .422 | .386 | 1.125 | .750 | .688 | | | 1.609 | | .625-24NEF | |
| 14 | 10-113138-14 | M85049/2-6C | .750-20UNEF | .422 | .500 | 1.078 | .875 | .812 | .428 | .230 | 1.390 | 1.375 | .750-20UNEF | 1.031 |
| | 10-113138-15 | M85049/2-6C | .750-20UNEF | .422 | .500 | 1.125 | .875 | .812 | | | 1.609 | | .750-20UNEF | |
| 16 | 10-113138-16 | M85049/2-8C | .875-20UNEF | .422 | .625 | 1.078 | 1.000 | .938 | .515 | .316 | 1.390 | 1.375 | .875-20UNEF | 1.125 |
| | 10-113138-17 | M85049/2-8C | .875-20UNEF | .422 | .625 | 1.125 | 1.000 | .938 | | | 1.609 | | .875-20UNEF | |
| 18 | 10-113138-18 | M85049/2-10C | 1.000-20UNEF | .422 | .752 | 1.125 | 1.188 | 1.062 | .614 | .378 | 1.609 | 1.437 | 1.000-20UNEF | 1.234 |
| 20 | 10-113138-20 | M85049/2-12C | 1.1875-18UNEF | .422 | .891 | 1.125 | 1.312 | 1.250 | .738 | .445 | 1.609 | 1.437 | 1.125-18NEF | 1.484 |
| 22 | 10-113138-22 | M85049/2-12C | 1.1875-18NEF | .422 | .891 | 1.125 | 1.438 | 1.250 | .738 | .445 | 1.609 | 1.437 | 1.250-18NEF | 1.484 |
| 24 | 10-113138-24 | M85049/2-16C | 1.4375-18UNEF | .422 | 1.111 | 1.125 | 1.562 | 1.500 | .926 | .611 | 1.609 | 1.562 | 1.375-18NEF | 1.671 |
| 28 | 10-113138-28 | M85049/2-16C | 1.4375-18NEF | .422 | 1.111 | 1.297 | 1.812 | 1.500 | .926 | .611 | 1.781 | 1.562 | 1.625-18NEF | 1.671 |
| 32 | 10-113138-32 | M85049/2-20C | 1.750-18UNS | .484 | 1.422 | 1.297 | 2.062 | 1.875 | 1.200 | .922 | 1.781 | 1.812 | 1.875-16UN | 2.188 |
| 36 | 10-113138-36 | M85049/2-24C | 2.000-18UNS | .562 | 1.672 | 1.297 | 2.250 | 2.125 | 1.363 | .922 | 1.781 | 2.062 | 2.0625-16N | 2.344 |
| 40 | 10-113138-40 | M85049/2-28C | 2.250-16UN | .562 | 1.914 | 1.297 | 2.500 | 2.375 | 1.611 | 1.180 | 1.781 | 2.062 | 2.3125-16N | 2.594 |
| 44 | 10-113138-44 | M85049/2-32C | 2.500-16UN | .562 | 2.142 | 1.297 | 2.812 | 2.625 | 1.865 | 1.427 | 1.781 | 2.188 | 2.625-16UN | 2.812 |

MS3420-()A sleeve



| Shell Size | Sleeve MS Part Number | D Dia. ±.016 | Z Dia | |
|------------|-----------------------|--------------|------------|--------|
| | | | Free ±.016 | Closed |
| 12 | MS3420-4A | .302 | .219 | .010 |
| | MS3420-6A | .427 | .312 | .114 |
| 16 | MS3420-6A | .427 | .312 | .085 |
| | MS3420-8A | .531 | .438 | .220 |
| 18 | MS3420-6A | .427 | .312 | .085 |
| | MS3420-10A | .615 | .438 | .200 |
| 20 | MS3420-10A | .615 | .438 | .177 |
| | MS3420-12A | .740 | .541 | .270 |
| 22 | MS3420-10A | .615 | .438 | .177 |
| | MS3420-12A | .740 | .541 | .270 |
| 24 | MS3420-8A | .531 | .438 | .186 |
| | MS3420-12A | .740 | .541 | .260 |
| | MS3420-16A | .927 | .750 | .433 |
| 26 | MS3420-8A | .531 | .438 | .186 |
| | MS3420-12A | .740 | .541 | .260 |
| | MS3420-16A | .927 | .750 | .433 |
| 32 | MS3420-12A | .740 | .541 | .273 |
| | MS3420-16A | .927 | .750 | .442 |
| | MS3420-20A | 1.240 | .938 | .620 |
| 36 | MS3420-16A | .927 | .750 | .358 |
| | MS3420-20A | 1.240 | .938 | .504 |
| | MS3420-24A | 1.365 | 1.125 | .682 |
| 40 | MS3420-16A | .927 | .750 | .368 |
| | MS3420-20A | 1.240 | .938 | .514 |
| | MS3420-28A | 1.614 | 1.250 | .816 |
| 44 | MS3420-20A | 1.240 | .938 | .638 |
| | MS3420-28A | 1.614 | 1.250 | .897 |
| | MS3420-32A | 1.865 | 1.625 | 1.229 |

Sleeve not supplied as part of MS3057-()C assembly. Order separately by part number shown.

QWL – accessories

protection caps

10-101046-(), 10-101531-()
plug protective covers

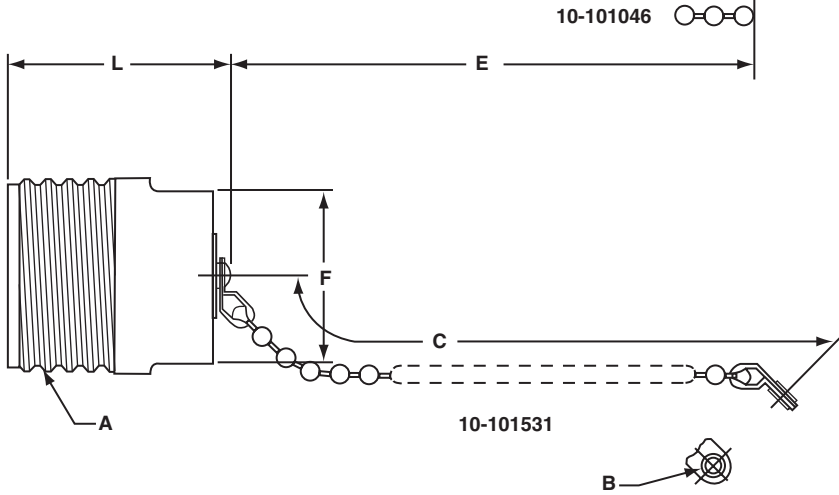

10-101063-(), 10-101048-()
receptacle protective covers

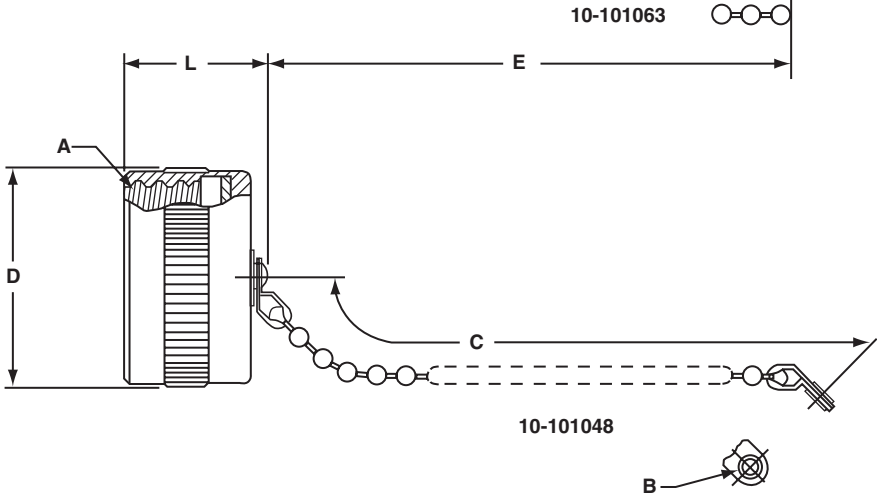

QWL – accessories

protection caps

All dimensions for reference only.

| Shell Size | Without Eyelet End Part Number* | With Eyelet End Part Number* | A Thread Class 2A | B Dia +.010 -.000 | C Approx. | E Approx. | F Flat ±.010 | L Max. |
|------------|---------------------------------|------------------------------|---------------------|-------------------------|-----------|-----------|-----------------|--------|
| 10 | 10-101046-10 | 10-101531-10 | .6250-0.05P-0.1L-DS | .125 | 3.000 | 3.375 | .500 | 1.250 |
| 12 | 10-101046-12 | 10-101531-12 | .7500-0.1P-0.2L-DS | .125 | 3.500 | 3.875 | .625 | 1.438 |
| 14 | 10-101046-14 | 10-101531-14 | .8750-0.1P-0.2L-DS | .125 | 3.500 | 3.875 | .750 | 1.438 |
| 16 | 10-101046-16 | 10-101531-16 | 1.0000-0.1P-0.2L-DS | .140 | 3.500 | 3.875 | .875 | 1.438 |
| 18 | 10-101046-18 | 10-101531-18 | 1.1250-0.1P-0.2L-DS | .140 | 3.500 | 4.000 | 1.000 | 1.438 |
| 20 | 10-101046-20 | 10-101531-20 | 1.2500-0.1P-0.2L-DS | .193 | 4.000 | 4.500 | 1.062 | 1.438 |
| 22 | 10-101046-22 | 10-101531-22 | 1.3750-0.1P-0.2L-DS | .193 | 4.000 | 4.500 | 1.125 | 1.438 |
| 24 | 10-101046-24 | 10-101531-24 | 1.5000-0.1P-0.2L-DS | .193 | 4.500 | 5.000 | 1.250 | 1.438 |
| 28 | 10-101046-28 | 10-101531-28 | 1.7500-0.1P-0.2L-DS | .193 | 4.500 | 5.000 | 1.500 | 1.438 |
| 32 | 10-101046-32 | 10-101531-32 | 2.0000-0.1P-0.2L-DS | .193 | 5.000 | 5.500 | 1.750 | 1.438 |
| 36 | 10-101046-36 | 10-101531-36 | 2.2500-0.1P-0.2L-DS | .193 | 5.000 | 5.500 | 2.000 | 1.438 |
| 40 | 10-101046-40 | 10-101531-40 | 2.5000-0.1P-0.2L-DS | .193 | 5.000 | 5.500 | 2.250 | 1.438 |
| 44 | 10-101046-44 | 10-101531-44 | 2.7500-0.1P-0.2L-DS | .193 | 6.000 | 6.000 | 2.500 | 1.438 |
| 48 | 10-101046-48 | 10-101531-48 | 3.0000-0.1P-0.2L-DS | .193 | 6.000 | 6.000 | 2.750 | 1.438 |

*For complete order number see page 5.

All dimensions for reference only.

| Shell Size | Without Eyelet End Part Number* | With Eyelet End Part Number* | A Thread Class 2B | B Dia. +.010 -.000 | C Approx. | D Dia. Max. | E Approx. | L Max. |
|------------|---------------------------------|------------------------------|---------------------|--------------------------|-----------|----------------|-----------|--------|
| 10 | 10-101063-10 | 10-101048-10 | .6250-0.05P-0.1L-DS | .140 | 3.000 | .844 | 3.375 | .750 |
| 12 | 10-101063-12 | 10-101048-12 | .7500-0.1P-0.2L-DS | .140 | 3.500 | .969 | 3.875 | .750 |
| 14 | 10-101063-14 | 10-101048-14 | .8750-0.1P-0.2L-DS | .140 | 3.500 | 1.094 | 3.875 | .750 |
| 16 | 10-101063-16 | 10-101048-16 | 1.0000-0.1P-0.2L-DS | .140 | 3.500 | 1.219 | 3.875 | .750 |
| 18 | 10-101063-18 | 10-101048-18 | 1.1250-0.1P-0.2L-DS | .193 | 3.500 | 1.344 | 4.000 | .969 |
| 20 | 10-101063-20 | 10-101048-20 | 1.2500-0.1P-0.2L-DS | .193 | 4.000 | 1.469 | 4.500 | .969 |
| 22 | 10-101063-22 | 10-101048-22 | 1.3750-0.1P-0.2L-DS | .193 | 4.000 | 1.562 | 4.500 | .969 |
| 24 | 10-101063-24 | 10-101048-24 | 1.5000-0.1P-0.2L-DS | .193 | 4.500 | 1.688 | 5.000 | .969 |
| 28 | 10-101063-28 | 10-101048-28 | 1.7500-0.1P-0.2L-DS | .193 | 4.500 | 1.938 | 5.000 | .969 |
| 32 | 10-101063-32 | 10-101048-32 | 2.0000-0.1P-0.2L-DS | .193 | 5.000 | 2.219 | 5.500 | .969 |
| 36 | 10-101063-36 | 10-101048-36 | 2.2500-0.1P-0.2L-DS | .193 | 5.000 | 2.469 | 5.500 | .969 |
| 40 | 10-101063-40 | 10-101048-40 | 2.5000-0.1P-0.2L-DS | .193 | 5.000 | 2.719 | 5.500 | .969 |
| 44 | 10-101063-44 | 10-101048-44 | 2.7500-0.1P-0.2L-DS | .193 | 6.000 | 2.969 | 6.000 | .969 |
| 48 | 10-101063-48 | 10-101048-48 | 3.0000-0.1P-0.2L-DS | .193 | 6.000 | 3.219 | 6.000 | .969 |

*For complete order number see page 5.

QWL – accessories

flange gasket, grip banding clamp

10-36675-()
10-40450-()
flange gaskets

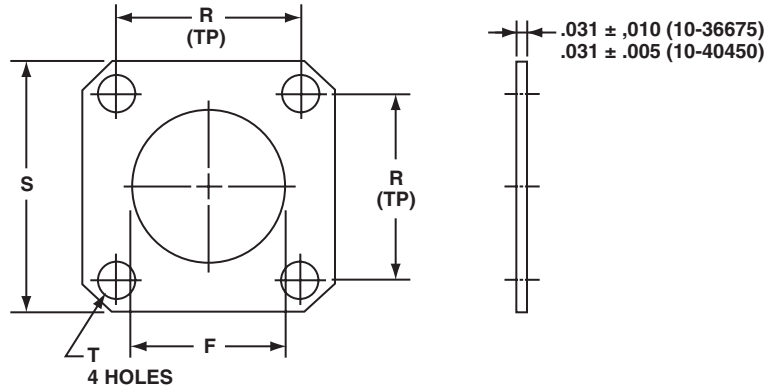

All dimensions for reference only.

| Part Number* | Part Number* | Shell Size | F Dia. +.016 -.000 | R ±.010 | S +.016 -.000 | T Dia. ±.010 |
|--------------|--------------|------------|--------------------------|------------|---------------------|--------------------|
| 10-36675-10 | 10-40450-10 | 10 | .625 | .719 | 1.000 | .172 |
| 10-36675-12 | 10-40450-12 | 12 | .750 | .813 | 1.094 | .172 |
| 10-36675-14 | 10-40450-14 | 14 | .875 | .906 | 1.188 | .172 |
| 10-36675-16 | 10-40450-16 | 16 | 1.000 | .969 | 1.281 | .172 |
| 10-36675-18 | 10-40450-18 | 18 | 1.125 | 1.063 | 1.375 | .203 |
| 10-36675-20 | 10-40450-20 | 20 | 1.250 | 1.156 | 1.500 | .203 |
| 10-36675-22 | 10-40450-22 | 22 | 1.375 | 1.250 | 1.625 | .203 |
| 10-36675-24 | 10-40450-24 | 24 | 1.500 | 1.375 | 1.750 | .203 |
| 10-36675-28 | 10-40450-28 | 28 | 1.750 | 1.563 | 2.000 | .203 |
| 10-36675-32 | 10-40450-32 | 32 | 2.000 | 1.750 | 2.250 | .219 |
| 10-36675-36 | 10-40450-36 | 36 | 2.188 | 1.938 | 2.500 | .219 |
| 10-36675-40 | 10-40450-40 | 40 | 2.438 | 2.188 | 2.750 | .219 |
| 10-36675-44 | 10-40450-44 | 44 | 2.688 | 2.375 | 3.000 | .219 |
| 10-36675-48 | 10-40450-48 | 48 | 2.938 | 2.625 | 3.250 | .219 |

*For complete order number see page 5.

10-183249-()
grip banding clamp

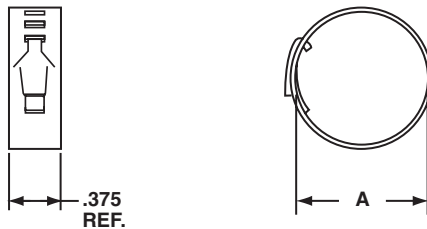

All dimensions for reference only.

| Part Number* | A Dia. | |
|--------------|--------|-------|
| | Max. | Min. |
| 10-183249-10 | 1.125 | .812 |
| 10-183249-11 | 1.312 | .938 |
| 10-183249-12 | 1.500 | 1.125 |
| 10-183249-13 | 1.688 | 1.312 |
| 10-183249-14 | 1.875 | 1.500 |
| 10-183249-15 | 2.062 | 1.688 |
| 10-183249-16 | 2.250 | 1.875 |
| 10-183249-17 | 2.438 | 2.062 |
| 10-183249-18 | 2.625 | 2.250 |
| 10-183249-19 | 2.812 | 2.438 |
| 10-183249-20 | 3.000 | 2.625 |

*For complete order number see page 5.

QWL

crimp contacts

Machined from copper alloy and silver-plated for maximum corrosion resistance, with a minimum millivolt drop and a maximum current carrying capacity, the size 16 and 12 socket contacts are of the closed entry design. Crimp contacts are available for all MS insert arrangements and are identified with an Amphenol® proprietary number.

MS/STANDARD CRIMP CONTACTS

| Part Number | Pin/Socket | Mating End Size | Wire Barrel Size | Allowable Wire Size | Required Wire Adapter Sleeve | Test Current** Amps |
|---------------------------|------------|-----------------|------------------|---------------------|------------------------------|---------------------|
| 10-40553 | Pin | 16 Short† | 16 | 16 | 10-74696-6 | 13 |
| 10-40552 or 10-597109-161 | Socket | | | 18 | | 10 |
| | | | | 20 | | 7.5 |
| | | | | 22* | | 5 |
| 10-40557 | Pin | 16 Long | 16 | 16 | 10-74696-6 | 13 |
| 10-40556 or 10-597109-171 | Socket | | | 18 | | 10 |
| | | | | 20 | | 7.5 |
| | | | | 22* | | 5 |
| 10-40561 | Pin | 12 | 12 | 12 | | 23 |
| 10-40560 or 10-597109-131 | Socket | | | 14 | | 17 |
| 10-40792 | Pin | 8 | 8 | 8 | 10-74696-1 | 46 |
| 10-40793 | Socket | | | 10* | | 33 |
| 10-40564 | Pin | 4 | 4 | 4 | 10-74696-2 | 80 |
| 10-40565 | Socket | | | 6* | | 60 |
| 10-40562 or 10-581806 | Pin | 0 | 0 | 0 | | 150 |
| 10-40563 or 10-581808 | Socket | | | 2* | | 100 |

* When using wire adapter sleeve shown.

** Contact ratings as stated are test ratings only. The connector could not withstand full rated current through all contacts continuously. Please note that the electrical data given is not an establishment of electrical safety factors. This is left entirely in the designer's hands as he can best determine which peak voltage, switching surges, transients, etc. can be expected in a particular circuit.

† The 12S, 14S and 16S connectors require short contacts.

TABLE I

CONTACT ARRANGEMENT SERVICE RATING

| MS Service Rating | Recommended Operating Voltage* at Sea Level | | Effective Creepage Distance Nom. | Mechanical Spacing Nom. |
|-------------------|---|----------|----------------------------------|-------------------------|
| | DC | AC (RMS) | | |
| Inst. | 250 | 200 | 1/16 | |
| A | 700 | 500 | 1/8 | 1/16 |
| D | 1250 | 900 | 3/16 | 1/8 |
| E | 1750 | 1250 | 1/4 | 3/16 |
| B | 2450 | 1750 | 5/16 | 1/4 |
| C | 4200 | 3000 | 1 | 5/16 |

* The values listed in Table I represent operating values which include a generous safety factor. It may be necessary for some applications to exceed the operating voltages listed here. If this is necessary, designers will find Table II useful for determining the degree to which the recommended values of Table I can be exceeded.

TABLE II
ALTITUDE VOLTAGE DERATING CHART**

| MS Service Rating | Nominal Distance | | Standard Sea Level Conditions | | Pressure Altitude† 50,000 Feet | | Pressure Altitude† 70,000 Feet | |
|-------------------|------------------|----------|------------------------------------|-----------------------|------------------------------------|-----------------------|------------------------------------|-----------------------|
| | Airspace | Creepage | Minimum Flashover Voltage AC (RMS) | Test Voltage AC (RMS) | Minimum Flashover Voltage AC (RMS) | Test Voltage AC (RMS) | Minimum Flashover Voltage AC (RMS) | Test Voltage AC (RMS) |
| Inst. | 1/32 | 1/16 | 1400 | 1000 | 500 | 400 | 325 | 260 |
| A | 1/16 | 1/8 | 2800 | 2000 | 800 | 600 | 450 | 360 |
| D | 1/8 | 3/16 | 3600 | 2800 | 900 | 675 | 500 | 400 |
| E | 3/16 | 1/4 | 4500 | 3500 | 1000 | 750 | 550 | 440 |
| B | 1/4 | 5/16 | 5700 | 4500 | 1100 | 825 | 600 | 480 |
| C | 5/16 | 1 | 8500 | 7000 | 1300 | 975 | 700 | 560 |

† Not corrected for changes in density due to variations in temperature.

** No attempt has been made to recommend operating voltages. The designer must determine his own operating voltage by the application of a safety factor to the above derating chart to compensate for circuit transients, surges, etc.

QWL solder contacts

Machined copper alloy contacts in a full range of sizes, with closed entry socket design in the size 12 and 16 contacts. A heavy silver-plated finish is deposited on all MS style solder contacts for maximum corrosion resistance, maximum current carrying capacity and low millivolt drop.

MS/STANDARD SOLDER CONTACTS*

| Part Number | Pin/Socket | Mating End Size | Wire Barrel Size | Allowable Wire Size | Test Current** Amps |
|---------------|------------|-----------------|------------------|---------------------|---------------------|
| 10-40569 | Pin | 16 Short† | 16 | 16 | 13 |
| 10-597107-161 | Socket | | | 18 | 10 |
| | | | | 20 | 7.5 |
| | | | | 22 | 5 |
| 10-40599 | Pin | 16 Long | 16 | 16 | 13 |
| 10-597107-171 | Socket | | | 18 | 10 |
| | | | | 20 | 7.5 |
| | | | | 22 | 5 |
| 10-33646 | Pin | 12 | 12 | 12 | 23 |
| 10-597107-131 | Socket | | | 14 | 17 |
| 10-35531 | Pin | 8 | 8 | 8 | 46 |
| 10-35532 | Socket | | | 10 | 33 |
| 10-35529 | Pin | 4 | 4 | 4 | 80 |
| 10-35530 | Socket | | | 6 | 60 |
| 10-35527 | Pin | 0 | 0 | 0 | 150 |
| 10-35528 | Socket | | | 1 | 125 |
| | | | | 2 | 100 |

* Solder Wells Filled

** Contact ratings as stated are test ratings only. The connector could not withstand full rated current through all contacts continuously. Please note that the electrical data given is not an establishment of electrical safety factors. This is left entirely in the designer's hands as he can best determine which peak voltage, switching surges, transients, etc. can be expected in a particular circuit.

† The 12S, 14S and 16S connectors require short contacts.

**TABLE I
CONTACT ARRANGEMENT SERVICE RATING**

| MS Service Rating | Recommended Operating Voltage* at Sea Level | | Effective Creepage Distance Nom. | Mechanical Spacing Nom. |
|-------------------|---|----------|----------------------------------|-------------------------|
| | DC | AC (RMS) | | |
| Inst. | 250 | 200 | 1/16 | |
| A | 700 | 500 | 1/8 | 1/16 |
| D | 1250 | 900 | 3/16 | 1/8 |
| E | 1750 | 1250 | 1/4 | 3/16 |
| B | 2450 | 1750 | 5/16 | 1/4 |
| C | 4200 | 3000 | 1 | 5/16 |

* The values listed in Table I represent operating values which include a generous safety factor. It may be necessary for some applications to exceed the operating voltages listed here. If this is necessary, designers will find Table II useful for determining the degree to which the recommended values of Table I can be exceeded.

**TABLE II
ALTITUDE VOLTAGE DERATING** CHART**

| MS Service Rating | Nominal Distance | | Standard Sea Level Conditions | | Pressure Altitude† 50,000 Feet | | Pressure Altitude† 70,000 Feet | |
|-------------------|------------------|----------|------------------------------------|-----------------------|------------------------------------|-----------------------|------------------------------------|-----------------------|
| | Airspace | Creepage | Minimum Flashover Voltage AC (RMS) | Test Voltage AC (RMS) | Minimum Flashover Voltage AC (RMS) | Test Voltage AC (RMS) | Minimum Flashover Voltage AC (RMS) | Test Voltage AC (RMS) |
| Inst. | 1/32 | 1/16 | 1400 | 1000 | 500 | 400 | 325 | 260 |
| A | 1/16 | 1/8 | 2800 | 2000 | 800 | 600 | 450 | 360 |
| D | 1/8 | 3/16 | 3600 | 2800 | 900 | 675 | 500 | 400 |
| E | 3/16 | 1/4 | 4500 | 3500 | 1000 | 750 | 550 | 440 |
| B | 1/4 | 5/16 | 5700 | 4500 | 1100 | 825 | 600 | 480 |
| C | 5/16 | 1 | 8500 | 7000 | 1300 | 975 | 700 | 560 |

† Not corrected for changes in density due to variations in temperature.

** No attempt has been made to recommend operating voltages. The designer must determine his own operating voltage by the application of a safety factor to the above derating chart to compensate for circuit transients, surges, etc.

QWL

application tools (crimp type)

Complete installation instructions (L-516) for Amphenol® QWL Series Connectors are available on request.

The following data includes information pertaining to the application tools which have been established for crimping, inserting and removing crimp contacts used in QWL Series Connectors.

Contact Crimping, Insertion & Removal Tools

| Crimping Tool | Positioner/ Turret | Contact Size | Contact Style | Insertion Tool | Removal Tool |
|---------------|-----------------------|--------------|---------------|----------------|-------------------------------------|
| M22520/1-01 | * | 16 | Pin & Socket | 11-7345 | 11-8250 Kit |
| M22520/1-01 | * | 12 | Pin & Socket | 11-7082 | 11-8250 Kit |
| * | * | 8 | Pin & Socket | 11-8220 | 11-8250 Kit |
| * | * | 4 | Pin & Socket | 11-7365-4† | Pin11-7370-4† Socket 11-7674-2† |
| * | * | 0 | Pin & Socket | 11-7365-5† | Pin 11-7370-5† Socket 11-7674-3† |

*Refer to tool manufacturers for appropriate crimp tools or positioner/turret.
†Tools used with Arbor press 11-7364.

QWL

thermocouple contacts

Available from Amphenol is a complete line of cylindrical connectors featuring thermocouple contact insert arrangements. The design of these contacts is such that standard shell components and resilient inserts are used in the assemblies. Thermocouple contacts are available in all arrangements which contain size 12 and 16 pins and sockets, and feature probe-proof, closed entry design for the socket contacts. MS-approved and other commercial arrangements may be ordered with thermocouple contacts substituted for the standard contacts. All thermocouple contact layouts may contain either iron, alumel, chromel, constantan, standard (copper) or brass (dummy) contacts. The resulting assembly will be identified with an Amphenol® part number.

IDENTIFICATION

For the purpose of wiring identification, thermocouple contacts are marked in accordance with the following color code which agrees with the wire code.

Chromel. White
Alumel Green
Iron Black
Constantan Yellow

This identification is made by means of small dots of stain on solder well end of the contact and is in accordance with the listing shown above.

WIRE WELL DATA

| Contact Size | | 12 | 16 |
|-------------------------------------|------------------|-----------|----------------------------------|
| Well Inside Diameter | + .004 - .002 | .125 | .094 |
| Well Depth | + .031 - .000 | .250 | .188 |
| Solder Well Barrel Outside Diameter | | .166±.003 | .125 ^{+ .002} - .004 |

RECOMMENDED WIRE:

- I Chromel – Alumel: Use wire in accordance with AN-W-29
- II Iron – Constantan: Use wire in accordance with AN-W-8b

QWL

thermocouple arrangements

Military connector specifications do not provide for thermocouple contact usage in established MS inserts. Amphe-nol® has established a series of insert arrangements containing thermocouple contacts. Some inserts have been rotated into positions outside those covered by MS

drawings to prevent cross plugging. Available thermocouple arrangements are tabulated on the following pages. Please contact your local sales office or Sidney, NY for additional information regarding thermocouple arrangements particular to your application.

The following abbreviations are used in the contact material column:

| Abbreviation | Ir. | Con. | Cu. | Ch. | Al. | Dummy |
|--------------|------|------------|--------|---------|--------|-------|
| Material | Iron | Constantan | Copper | Chromel | Alumel | Brass |

| Shell Size and Arrg.† | Similar To MS Arrg. | Total Con-tacts | Contact Size | | Pin Insert Rotation C/W | Contact Material |
|-----------------------|---------------------|-----------------|--------------|----|-------------------------|---|
| | | | 12 | 16 | | |
| 12S-51 | 12S-3 | 2 | | 2 | 315° | A = Ch.; B = Al. |
| 12S-54 | 12S-3 | 2 | | 2 | 315° | A = Ir.; B = Con. |
| 12S-55 | 12S-3 | 2 | | 2 | 45° | A = Cu.; B = Con. |
| 12S-56 | 12S-3 | 2 | | 2 | None | A = Al.; B = Ch. |
| 12S-57 | 12S-3 | 2 | | 2 | 60° | A = Ch.; B = Al. |
| 12S-58 | 12S-3 | 2 | | 2 | 120° | A = Ir.; B = Con. |
| 12S-59 | 12S-3 | 2 | | 2 | None | A = Ir.; B = Con. |
| 12S-60 | 12S-3 | 2 | | 2 | None | A = Cu.; B = Con. |
| 12S-61 | 12S-3 | 2 | | 2 | None | A = Ch.; B = Con. |
| 12S-62 | 12S-3 | 2 | | 2 | None | A = Ch.; B = Al. |
| 12S-64 | 12S-3 | 2 | | 2 | 315° | A = Cu.; B = Con. |
| 12S-65 | 12S-3 | 2 | | 2 | None | A = Con.; B = Ir. |
| 14S-51 | 14S-9 | 2 | | 2 | 90° | A = Al.; B = Ch. |
| 14S-52 | 14S-2 | 4 | | 4 | 45° | A, B = Cu.; C = Al.; D = Ch. |
| 14S-53 | 14S-9 | 2 | | 2 | 90° | A = Ir.; B = Con. |
| 14S-54 | 14S-6 | 6 | | 6 | 45° | A, C, E = Ir.; B, D, F = Con. |
| 14S-55 | 14S-2 | 4 | | 4 | 45° | A, C = Ir.; B, D = Con. |
| 14S-56 | 14S-2 | 4 | | 4 | 45° | A = Ir.; B = Con.; C, D = Cu. |
| 14S-57 | 14S-2 | 4 | | 4 | 45° | A, C = Al.; B, D = Ch. |
| 14S-58 | 14S-7 | 3 | | 3 | 45° | A = Al.; B = Ch.; C = Cu. |
| 14S-59 | 14S-9 | 2 | | 2 | 90° | A = Cu.; B = Con. |
| 14S-60 | 14S-9 | 2 | | 2 | * | A = Al.; B = Ch. |
| 14S-61 | 14S-6 | 6 | | 6 | 45° | A = Al.; B = Ch.; C = Ir.; D = Con.; E, F = Cu. |
| 14S-63 | 14S-6 | 6 | | 6 | * | A, C = Al.; B, D = Ch.; E = Ir.; F = Con. |
| 14S-64 | 14S-2 | 4 | | 4 | * | A, C = Con.; B, D = Cu. |
| 14S-65 | 14S-6 | 6 | | 6 | * | A, C, E = Cu.; B, D, F = Con. |
| 14S-67 | 14S-6 | 6 | | 6 | * | A = Al.; B = Ch.; Bal = Cu. |
| 14S-68 | 14S-2 | 4 | | 4 | 45° | A = Ch.; B = Con.; C, D = Cu. |
| 14S-69 | 14S-7 | 3 | | 3 | * | A = Con.; B = Ch.; C = Cu. |
| 14S-70 | 14S-2 | 4 | | 4 | * | A, D = Ch.; B, C = Al. |
| 14S-71 | 14S-2 | 4 | | 4 | * | A, B, D = Cu.; C = Con. |
| 14S-72 | 14S-9 | 2 | | 2 | * | A = Con.; B = Cu. |
| 14S-73 | 14S-2 | 4 | | 4 | * | A, B = Cu.; C = Al.; D = Ch. |

†Insert arrangements including the letter "S" are available in QWL Series Connectors only.*No rotation required.

QWL

thermocouple arrangements (Cont'd.)

| Shell Size and Arrg.† | Similar To MS Arrg. | Total Con-tacts | Contact Size | | Pin Insert Rotation C/W | Contact Material |
|-----------------------|---------------------|-----------------|--------------|----|-------------------------|---|
| | | | 12 | 16 | | |
| 14S-74 | 14S-2 | 4 | | 4 | * | A, B = Ch.; C, D = Al. |
| 14S-75 | 14S-2 | 4 | | 4 | * | A, B = Cu.; C, D = Con. |
| 14S-76 | 14S-2 | 4 | | 4 | * | A, C = Al.; B, D = Ch. |
| 14S-77 | 14S-2 | 4 | | 4 | * | A, D = Al.; B, C = Ch. |
| 14S-78 | 14S-9 | 2 | | 2 | * | A = Ch.; B = Al. |
| 14S-79 | 14S-5 | 5 | | 5 | * | A, B, E = Cu.; C = Al.; D = Ch. |
| 14S-80 | 14S-9 | 2 | | 2 | * | A = Cu.; B = Con. |
| 14S-81 | 14S-9 | 2 | | 2 | * | A = Al.; B = Cu. |
| 14S-82 | 14S-2 | 4 | | 4 | * | A = Ir.; B = Con.; C = Ch.; D = Al. |
| 14S-83 | 14S-6 | 6 | | 6 | * | A, C = Ir.; B, D = Con.; E, F = Cu. |
| 14S-84 | 14S-6 | 6 | | 6 | * | A, B = Al.; Bal = Cu. |
| 14S-85 | 14S-7 | 3 | | 3 | * | A = Ch.; B = Al.; C = Cu. |
| 14S-86 | 14S-6 | 6 | | 6 | * | A, F = Ir.; B, E = Con.; C, D = Cu. |
| 14S-87 | 14S-6 | 6 | | 6 | * | A, B, C, D = Ir.; E, F = Con. |
| 14S-88 | 14S-9 | 2 | | 2 | 90° | A = Ch.; B = Con. |
| 14S-89 | 14S-7 | 3 | | 3 | * | A = Ir.; B = Cu., C = Con. |
| 14S-90 | 14S-6 | 6 | | 6 | * | A = Al.; C = Ch.; Bal. = Cu. |
| 14S-91 | 14S-2 | 4 | | 4 | * | A = Al.; B = Ch.; Bal. = Cu. |
| 14S-93 | 14S-6 | 6 | | 6 | * | A, B, F = Al.; D, C, E = Ch. |
| 14-59 | 14-53 | 6 | | 6 | * | A = Al.; B = Ch.; C = Ir.; D = Con.; E, F = Cu. |
| 16S-52 | 16S-4 | 2 | | 2 | * | A = Ch.; B = Al. |
| 16S-54 | 16S-1 | 7 | | 7 | * | A = Al.; B = Ch.; Bal. = Cu. |
| 16S-55 | 16S-1 | 7 | | 7 | * | A = Con.; Bal. = Cu. |
| 16S-56 | 16S-1 | 7 | | 7 | * | A = Al.; D = Ch.; Bal. = Cu. |
| 16S-57 | 16S-1 | 7 | | 7 | * | A, B = Al.; C, D = Ch.; Bal. = Cu. |
| 16S-58 | 16S-1 | 7 | | 7 | * | A, G = Al.; Bal. = Ch. |
| 16S-59 | 16S-1 | 7 | | 7 | * | A, C = Ir.; B, D = Con.; Bal. = Cu. |
| 16S-60 | 16S-1 | 7 | | 7 | * | A = Ir.; B = Con.; Bal. = Cu. |
| 16S-61 | 16S-1 | 7 | | 7 | * | G = Al.; Bal. = Ch. |
| 16-52 | 16-11 | 2 | 2 | | 90° | A = Al.; B = Ch. |
| 16-53 | 16-9 | 4 | 2 | 2 | 70° | A = Al.; C = Ch.; B, D = Cu. |
| 16-55 | 16-10 | 3 | 3 | | 45° | A = Al.; B = Ch.; C = Cu. |
| 16-56 | 16-13 | 2 | 2 | | 90° | A = Con.; B = Cu. |
| 16-57 | 16-10 | 3 | 3 | | * | A = Al.; B = Cu.; C = Ch. |
| 16-58 | 16-10 | 3 | 3 | | * | A = Con.; B, C = Cu. |
| 16-60 | 16-13 | 2 | 2 | | * | A = Al.; B = Ch. |
| 16-62 | 16-11 | 2 | 2 | | * | A = Con.; B = Cu. |
| 16-67 | 16-11 | 2 | 2 | | * | A = Al.; B = Ch.; |
| 16-68 | 16-9 | 4 | 2 | 2 | * | A, B, C = Ch.; D = Al. |
| 18-51 | 18-12 | 6 | | 6 | * | A = Ir.; B, E = Con.; D = Cu.; C, F = Dummy |
| 18-52 | 18-11 | 5 | 5 | | * | A = Ir.; B = Con.; C = Ch.; D = Al.; E = Dummy |
| 18-53 | 18-12 | 6 | | 6 | * | A, D = Ir.; B, E = Con.; C, F = Dummy |
| 18-54 | 18-15 | 4 | 4 | | * | A, C = Al.; B, D = Ch. |
| 18-56 | 18-1 | 10 | | 10 | 45° | A, C, E, G, I = Ir.; B, D, F, H, J = Con. |
| 18-57 | 18-12 | 6 | | 6 | 45° | A, C, E = Al.; B, D, F = Ch. |
| 18-59 | 18-12 | 6 | | 6 | 45° | A, C = Ir.; B, E, F = Con.; D = Cu. |

†Insert arrangements including the letter "S" are available in QWL Series Connectors only.

*No rotation required.

QWL

thermocouple arrangements (Cont'd.)

| Shell Size and Arrg.† | Similar To MS Arrg. | Total Con-tacts | Contact Size | | Pin Insert Rotation C/W | Contact Material |
|-----------------------|---------------------|-----------------|--------------|----|-------------------------|--|
| | | | 12 | 16 | | |
| 18-60 | 18-11 | 5 | 5 | | 45° | A, D = Al.; B, C = Ch.; E = Al. |
| 18-61 | 18-12 | 6 | | 6 | * | A, C = Ir.; B, D = Con.; E = Ch.; F = Al. |
| 18-62 | 18-12 | 6 | | 6 | * | A, B, C = Ir.; D, E, F = Con. |
| 18-63 | 18-15 | 4 | 4 | | * | A, C = Con.; B, D = Cu. |
| 18-65 | 18-12 | 6 | | 6 | * | A = Ir.; B = Con.; Bal. = Cu. |
| 18-66 | 18-1 | 10 | | 10 | * | A, C, E, G, I = Cu.; B, D, F, H, J = Con. |
| 18-67 | 18-12 | 6 | | 6 | * | A, C, E = Cu.; B, D, F = Con. |
| 18-68 | 18-11 | 5 | 5 | | * | A, D = Al.; B, C = Ch.; E = Cu. |
| 18-69 | 18-1 | 10 | | 10 | * | A = Al.; B = Ch.; Bal. = Cu. |
| 18-70 | 18-11 | 5 | 5 | | * | A = Ir.; B = Con.; C = Ch.; D = Al.; E = Cu. |
| 18-71 | 18-15 | 4 | 4 | | * | A = Con.; Bal. = Cu. |
| 18-72 | 18-15 | 4 | 4 | | * | D = Con.; Bal. = Cu. |
| 18-73 | 18-9 | 7 | 2 | 5 | * | A = Al.; D = Ch.; Bal. = Cu. |
| 18-74 | 18-12 | 6 | | 6 | * | A = Ch.; B = Al., D = Ir.; E = Cu.; C, F = Con. |
| 18-76 | 18-1 | 10 | | 10 | * | A, C, E, G, I = Al.; B, D, F, H, J = Ch. |
| 18-77 | 18-1 | 10 | | 10 | * | A, C, E, G = Al.; B, D, F, H = Ch.; Bal. = Cu. |
| 18-78 | 18-1 | 10 | | 10 | * | A = Al.; B = Ch.; D, F, H, J = Con.; Bal. = Cu. |
| 18-79 | 18-12 | 6 | | 6 | * | A, F = Ir.; B, E = Con.; C, D = Cu. |
| 18-80 | 18-15 | 4 | 4 | | * | A, C = Cu.; B, D = Con. |
| 18-81 | 18-1 | 10 | | 10 | * | E, G = Con.; Bal. = Cu. |
| 18-82 | 18-1 | 10 | | 10 | * | E, G = Con.; F, H = Ir.; Bal. = Cu. |
| 20-52 | 20-4 | 4 | 4 | | 315° | A = Ir.; B = Con.; C = Ch.; D = Al. |
| 20-56 | 20-7 | 8 | | 8 | 45° | A, B, G, H = Ir.; C, D, E, F = Con. |
| 20-60 | 20-7 | 8 | | 8 | 45° | D = Ch.; E = Al.; Bal. = Cu. |
| 20-61 | 20-29 | 17 | | 17 | 45° | A, B, M = Cu.; Bal. = Con. |
| 20-62 | 20-15 | 7 | 7 | | 80° | A, C, E = Al.; B, D, F = Ch.; G = Cu. |
| 20-64 | 20-27 | 14 | | 14 | * | A = Al.; C = Ch.; Bal. = Cu. |
| 20-65 | 20-27 | 14 | | 14 | * | A, B, C, D, E, F, G = Ir.; H, I, J, K, L, M, N = Con. |
| 20-67 | 20-16 | 9 | 2 | 7 | * | H = Al.; I = Ch.; Bal. = Cu. |
| 20-68 | 20-7 | 8 | | 8 | * | A, B, G, H = Con.; C, D, E, F = Cu. |
| 20-69 | 20-27 | 14 | | 14 | * | A, B, C, D, E, F, G = Cu.; H, I, J, K, L, M, N = Con. |
| 20-70 | 20-29 | 17 | | 17 | * | A, C, E, G, J, L, N, R, T = Ir.; B, D, F, H, K, M, P, S = Con. |
| 20-71 | 20-29 | 17 | | 17 | * | S = Al.; R = Ch.; Bal. = Cu. |
| 20-74 | 20-29 | 17 | | 17 | * | A, C, E, G, J, L, N, R = Ir.; B, D, F, H, K, M, P, S = Con.; T = Cu. |
| 20-75 | 20-15 | 7 | 7 | | * | G = Al.; Bal = Ch. |
| 20-77 | 20-16 | 9 | 2 | 7 | * | A = Con.; Bal. = Std. |
| 20-80 | 20-27 | 14 | | 14 | * | A, C, E, G, I, K, M = Cu.; B, D, F, H, J, L, N = Con. |
| 20-81 | 20-27 | 14 | | 14 | * | A, C, E, G, I, K, M = Ch.; B, D, F, H, J, L, N = Al. |
| 20-82 | 20-29 | 17 | | 17 | * | A, C, E, G, J, L, N, R = Al.; B, D, F, H, K, M, P, S = Ch.; T = Cu. |
| 20-85 | 20-33 | 11 | | 11 | * | K, L = Al.; Bal. = Ch. |
| 20-87 | 20-29 | 17 | | 17 | * | A, C, E, G, J, L, N, R = Con.; Bal. = Cu. |
| 20-88 | 20-27 | 14 | | 14 | * | A, C, E = Al.; B, D, F = Ch.; G, H, K, N = Con.; Bal. = Cu. |
| 20-89 | 20-27 | 14 | | 14 | * | B, D, F, H, J, L = Al.; A, C, E, G, I, K = Ch.; M, N = Cu. |
| 20-90 | 20-27 | 14 | | 14 | * | C, G, I = Ch.; K, L, M = Al.; Bal. = Cu. |
| 20-91 | 20-27 | 14 | | 14 | * | I = Ch.; K = Al.; Bal. = Cu. |

*No rotation required.

QWL

thermocouple arrangements (Cont'd.)

| Shell Size and Arrg. | Similar To MS Arrg. | Total Con-tacts | Contact Size | | Pin Insert Rotation C/W | Contact Material |
|----------------------|---------------------|-----------------|--------------|----|-------------------------|---|
| | | | 12 | 16 | | |
| 20-92 | 20-7 | 8 | | 8 | * | A = Al.; H = Cu.; Bal. = Ch. |
| 20-93 | 20-27 | 14 | | 14 | * | A = Ch.; B = Al.; Bal. = Cu. |
| 20-94 | 20-15 | 7 | 7 | | * | A, C, E = Al.; B, D, F = Ch.; G = Cu. |
| 20-99 | 20-33 | 11 | | 11 | * | A = Al.; Bal. = Ch. |
| 22-57 | 22-14 | 19 | | 19 | 45° | A, C, E, G, J, L, N, R = Ir.; B, D, F, H, K, M, P, S = Con.; T, U, V = Cu. |
| 22-60 | 22-14 | 19 | | 19 | 45° | U = Al.; N = Ch.; Bal. = Cu. |
| 22-62 | 22-23 | 8 | 8 | | 60° | A, B, F, G = Al.; C, D, E, H = Ch. |
| 22-68 | 22-19 | 14 | | 14 | 45° | A, C, E, G, J, L, M = Ir.; B, D, F, H, K, P, N = Con. |
| 22-69 | 22-19 | 14 | | 14 | 45° | A, C, E, G, J, L, M = Cu.; B, D, F, H, K, P, N = Con. |
| 22-71 | 22-14 | 19 | | 19 | * | V = Al., U = Ch.; Bal. = Cu. |
| 22-72 | 22-5 | 6 | 2 | 4 | * | B = Al.; E = Ch.; Bal. = Cu. |
| 22-73 | 22-5 | 6 | 2 | 4 | * | E = Al.; B = Ch.; Bal. = Cu. |
| 22-74 | 22-23 | 8 | 8 | | * | A, C, E, G = Ir.; B, D, F, H = Con. |
| 22-75 | 22-23 | 8 | 8 | | * | A = Al.; B, D, G, H = Cu.; C = Ch.; E = Ir.; F = Con. |
| 22-76 | | 21 | | 21 | * | W = Con.; Bal. = Cu. |
| 22-77 | 22-19 | 14 | | 14 | * | B, D, F, H, J, K, M, P = Cu.; A, E, L = Ir.; C, G, N = Con. |
| 22-78 | 22-14 | 19 | | 19 | * | A, C, E, G, H, K, M, P, R, T = Con.; Bal. = Cu. |
| 22-79 | 22-10 | 4 | | 4 | * | A, C = Con.; B, D = Cu. |
| 22-82 | 22-14 | 19 | | 19 | * | A, C, E, G, J, L, N, R, T = Ir.; B, D, F, H, K, M, P, S, U = Con.; V = Cu. |
| 22-83 | 22-18 | 8 | | 8 | * | A, C, E, G = Al.; B, D, F, H = Ch. |
| 22-84 | 22-14 | 19 | | 19 | * | A, C, S = Ch.; B, D, T = Al.; Bal. = Cu. |
| 22-85 | 22-19 | 14 | | 14 | * | A, C, E, G, J, L, N = Al.; B, D, F, H, K, M, P = Ch. |
| 22-89 | 22-28 | 7 | 7 | | * | A, C, E = Ir.; B, D, F = Con.; G = Cu. |
| 24-56 | 24-20 | 11 | 2 | 9 | 45° | E = Al.; F = Ch.; Bal. = Cu. |
| 24-57 | 24-28 | 24 | | 24 | 45° | A, C, J, V, Y, W, K, E, H, U, S, M = Ch.; Bal. = Al. |
| 24-62 | 24-28 | 24 | | 24 | * | A, C, E, G = Ir.; B, D, F, H = Con.; R, T = Ch.; S, U = Al.; Bal. = Cu. |
| 24-63 | 24-28 | 24 | | 24 | * | A, C, E, G, J, L, K, N, S, U, W, Y = Cu.; B, D, F, H, Q, R, M, P, T, V, X, Z = Con. |
| 24-64 | 24-5 | 16 | | 16 | * | A, B, C, D, E, F, G, H = Ir.; J, K, L, M, N, P, R, S = Con. |
| 24-68 | 24-28 | 24 | | 24 | * | D = Con.; Bal. = Cu. |
| 24-81 | 24-7 | 16 | 2 | 14 | * | A, C, E, G, I, K, M, N, P = Cu.; B, D, F, H, J, L, O = Con. |
| 24-88 | 24-28 | 24 | | 24 | * | A, B, C, D, E, F, G, H, J, K, L, M = Con.; Bal. = Ir. |
| 24-91 | 24-5 | 16 | | 16 | * | A, B, C, D, E, F, G, H = Al.; J, K, L, M, N, P, R, S = Ch. |
| 28-53 | 28-11 | 22 | 4 | 18 | 45° | J, L = Al.; K, M = Ch.; Bal. = Cu. |
| 28-58 | 28-20 | 14 | 10 | 4 | 45° | A, C, E, G, K, M = Al.; B, D, F, H, L, N = Ch.; J, P = Cu. |
| 28-61 | 28-21 | 37 | | 37 | 45° | A, C, J, Z, m, r, n, a, K, F, H, X, k, h, T, M, N, d = Ir.; Bal. = Con. |
| 28-63 | 28-20 | 14 | 10 | 4 | 45° | A, C, E, G, J = Al.; B, D, F, H, P = Ch.; Bal. = Cu. |
| 28-64 | 28-15 | 35 | | 35 | * | A, d = Al.; B, j = Ch.; C, D, E, F, G, N, P, R, S, H, J, K, L, M, W, X, Y, Z = Con.; Bal. = Cu. |
| 28-65 | 28-12 | 26 | | 26 | * | A, C, E, G, J, L, N, R, T, V = Ir.; X, Z = Al.; B, D, F, H, K, M, P, S, U, W = Con.; Y, a = Ch.; b, d = Cu. |
| 28-67 | 28-16 | 20 | | 20 | * | U = Con.; Bal. = Cu. |
| 28-68 | 28-15 | 35 | | 35 | 45° | T = Al.; U = Ch.; Bal. = Cu. |
| 28-69 | 28-11 | 22 | 4 | 18 | * | G = Al.; R = Ch.; Bal. = Cu. |
| 28-70 | 28-11 | 22 | 4 | 18 | * | A = Al.; B = Ch.; Bal. = Cu. |
| 28-77 | 28-11 | 22 | 4 | 18 | * | J = Con.; Bal. = Cu. |

QWL

thermocouple arrangements (Cont'd.)

| Shell Size and Arrg. | Similar To MS Arrg. | Total Con-acts | Contact Size | | Pin Insert Rotation C/W | Contact Material |
|----------------------|---------------------|----------------|--------------|-----|-------------------------|--|
| | | | 12 | 16 | | |
| 28-81 | 28-21 | 37 | | 37 | * | A, D, S, Z, n, s = Ir.; B, J, K, f, g, r, = Con.; G, L, P, b, e, j = Al.; F, H, T, X, h, k = Ch.; Bal. = Cu. |
| 28-85 | 28-11 | 22 | 4 | 18 | 45° | K, M = Al.; J, L = Ch.; Bal. = Cu. |
| 28-91 | 28-9 | 12 | 6 | 6 | * | M = Ir.; L = Con.; Bal. = Cu. |
| 28-94 | 28-12 | 26 | | 26 | * | B, D, F, H, K, M, P, S, U, W, Y, a, d = Al.; Bal. = Ch. |
| 28-98 | 28-21 | 37 | | 37 | * | M = Al.; F = Ch.; Bal. = Cu. |
| 28-99 | 28-12 | 26 | | 26 | * | B, D, F, H, K, M, P, S, U, W, Y, a = Con.; Bal. = Cu. |
| 28-AC | 28-16 | 20 | | 20 | * | A, C, E, G, J, L = Ir.; B, D, F, N, K, M = Con.; Bal. = Cu. |
| 28-AD | 28-21 | 37 | | 37 | 45° | A, C, F, H, J, K, M, N, T, X, Z, a, d, h, k, m, n, r = Cu.; Bal. = Con. |
| 28-AE | 28-21 | 37 | | 37 | * | A, C, E, G, J, L, N, R, T, V, X, a, c, e, g, j, m, p, s = Cu.; Bal. = Con. |
| 28-AF | 28-18 | 12 | | 12 | * | A, C, E, G, J, L = Ch.; Bal. = Al. |
| 28-AG | 28-12 | 26 | | 26 | * | A, C, E, G, J, L, N, R = Al.; B, D, F, H, K, M, P, S = Ch.; Bal. = Cu. |
| 28-AK | 28-21 | 37 | | 37 | * | A, B, C, D, J, K, L, M, N, P, X, a, b, c, d, e, m, p = Ch.; n = Cu.; Bal. = Al. |
| 32-51 | 32-8 | 30 | 6 | 24 | 90° | M = Ch.; N = Al.; Bal. = Cu. |
| 32-55 | 32-8 | 30 | 6 | 24 | 125° | M, N, = Ch.; O, P = Al.; Bal. = Cu. |
| 32-91 | 32-64 | 54 | | 54 | * | A, C, E, G, J, L, N, P, S, U, W, Y, a, c, e, g, j, m = Ir.; B, D, F, H, K, M, O, R, T, V, X, Z, b, d, f, h, k, n = Con.; Bal. = Cu. |
| 36-53 | 36-7 | 47 | 7 | 40 | 45° | u, v, w = Al.; x, y, z = Ch.; Bal. = Cu. |
| 36-56 | 36-10 | 48 | | 48 | * | A, C, E, G, L, J, H, P, R, T, V, X, Z, b, d, f, h, k, q, n, m, u, w, y = Con.; Bal. = Cu. |
| 36-57 | 36-8 | 47 | 1 | 46 | * | W = Al.; f = Ch.; Bal. = Cu. |
| 36-58 | 36-15 | 35 | | 35 | * | H = Al.; G = Ch.; Bal. = Cu. |
| 36-61 | 36-15 | 35 | | 35 | * | A, C, E, J, K, L, M, N, P, R, T, V, f, X, Y, h, j, c = Con.; Bal. = Cu. |
| 36-62 | 36-10 | 48 | | 48 | * | A, C, E = Al.; B, D, F = Ch.; Bal. = Cu. |
| 36-82 | 36-52†† | 52 | | 52 | * | v, g = Ir.; p, y, c = Con.; x = Ch.; Bal. = Cu. |
| 36-86 | 36-10 | 48 | | 48 | * | A, C, E, G, J, L, N, P, R, T, V, X = Al.; B, D, F, H, K, M, O, Q, S, U, W, Y = Ch.; z, b, d, f, h, k, n, q, s, u, w, y = Con.; a, c, e, g, j, m, p, r, t, v, x, z = Cu. |
| 36-88 | 36-52 | 52 | | 52 | * | A, C, E, H, K, M, P, S, U, W, Y, a, c, f, h, j, m, p, r, t, v, x, z, AB, AD, AF = Cu.; Bal. = Con. |
| 40-58 | 40-56†† | 85 | | 85 | * | A, C, E, H, K, M, P, S, U, W, Y, a, c, f, h, j, m, p, r, t, v, x, z, AB, AD, AF, AJ, AL, AN, AP, AS, AU, AW, AY, BA, BC, BE, BH, BK, BM, BP, BS, BU = Ir.; Bal. = Con. |
| 40-59 | 40-56†† | 85 | | 85 | * | B = Ch.; C = Con.; Bal. = Cu. |
| 40-77 | 40-53†† | 60 | | 60 | * | 55, 60 = Ir.; 57, 58, 59 = Con.; 56 = Ch.; Bal. = Cu. |
| 40-78 | 40-53†† | 60 | | 60 | * | 50, 51 = Ir.; 27, 28, 29, 31, 32, 34, 36, 37, = Con.; 25, 39, 40, 41 = Al.; 43, 44, 45, 46, 47, 48, 49, 52, 53, 54 = Ch.; Bal. = Cu. |
| 40-88 | 40-53 | 60 | | 60 | * | 1, 3, 5, 7, 9, 11, 13, 15, 17, 19, 21, 23, 25, 27, 29, 31, 33, 35, 37, 39, 41, 43, 45, 47, 49, 51, 53, 55, 57, 59 = Con.; Bal. = Cu. |
| 40-AA | 40-56 | 85 | | 85 | * | A, C, E, H, K, M, P, S, U, W, Y, a, c, f, h, j, m, p, r, t, v, x, z, AB, AD, AF, AJ, AL, AN, AR, AT = Cu.; B, D, F, J, L, N, R, T, V, X, Z, b, d, g, i, k, n, q, s, u, w, y, AA, AC, AE, AH, AK, AM, AP, AS = Con.; AU, AW, AY, BA, BC, BE, BH, BK, BM, BP, BS, BU = Ch.; AV, AX, AZ, BB, BD, BF, BJ, BL, BN, BR, BT, BV = Al. |
| 44-57 | 44-52 | 104 | | 104 | * | A, C, E, G, J, L, etc. = Cu.; B, D, F, H, K, M, etc. = Con. |
| 44-59 | 44-52 | 104 | | 104 | * | 34 = Con.; 70 = Cu. |
| 44-60 | 44-52 | 104 | | 104 | * | A, C, E, etc. = Ch., (52); B, D, F, etc. = Al. (52) |
| 44-62 | 44-52 | 104 | | 104 | * | BY, BZ, CA, CB, CC, CD, CE, CR = Al.; CH, CJ, CK, CL, CM, CN, CP CS = Ch.; Bal. = Cu. |

††Amphenol® arrangement*No rotation required.

Other Heavy Duty Cylindrical Connectors Offered by Amphenol

Class “L” MIL-C-22992, QWLD and Star-Line

Amphenol meets the demands for heavy duty connectors by providing three additional cylindrical connector series, each with unique design characteristics for reliable operation in specific industrial environments.

Class “L”, MIL-C-22992 – for the heaviest electrical loads; for military and industrial applications.

- MIL-C-22992 qualification.
- Current range from 40 to 200 amperes.
- Direct current or single/three phase, 60/400 Hertz alternating current.
- Rugged shells are resistant to vibration, high impact, shock and corrosion
- Double stub threads per MIL-STD-1373 for fast coupling and easy cleaning.
- Five key polarization system assures that circuits with incompatible power characteristics (voltage, phase and frequency) are not mated.
- Crimp termination. Contacts can be soldered.
- Automatic grounding for safety.
- Unique arc quenching capability provides a positive safety feature if connectors are inadvertently disconnected under load.
- 4 shell styles with 7 insert patterns that facilitate large conductors.
- Grommets and seals provide waterproofing.



Heavy Duty Class “L” Connectors

QWLD – for most power and control circuits

- Military (MIL-C-22992) qualified connectors and industrial equivalents available.
- Increased shell size for greater durability than similar standard connectors.
- Crimp or solder termination.
- Double stub threaded per MIL-STD-1373.
- 7 shell styles with over 300 insert patterns (MIL-C-5015 inserts plus specials)
- Class C is pressurized; Class R is environmental.

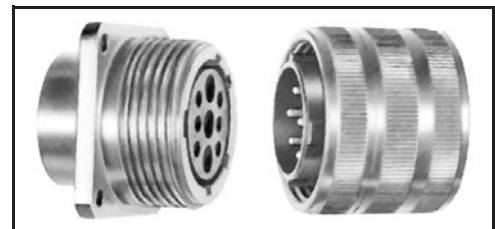

QWLD Series

Star-line® Series – heavy duty environmentally sealed plugs and receptacles that are used in all types of industrial and aerospace applications.

- Equals or exceeds MIL-C-5015 E and R specifications.
- UL listed and CSA listed circuit breaking capability.
- Up to high amperage of 1135 amps at 1000VAC or DC rating available.
- Solder, crimp and pressure terminals. Circuit breaking power and control types.
- Double lead Acme threads provide complete coupling in one turn of the coupling nut, and do not clog under adverse weather conditions.
- IP67 rating for environmental sealing.
- Hard anodic coating provides dielectric strength with heat and corrosion resistance.



Star-Line Series

Star-line EX® Series – Hybrid form of the Star-Line series with higher temperature ranges. Cenelec Certified for use in Zone 1-IIc hazardous environments. EX Certificate #03ATEX 1101X.

X-ON Electronics

Largest Supplier of Electrical and Electronic Components

Click to view similar products for [Amphenol](#) manufacturer:

Other Similar products are found below :

[PT01SE-16-8P\(027\)](#) [PT01SE-16-8P\(476\)](#) [CTV06RW-11-2JB-LC](#) [97-3108A-22-14P](#) [10-474017-10P](#) [MS27473P14B18S](#) [TV06RW-25-90AE](#)
[PT02E10-2PW](#) [PT02E10-2PX](#) [97-3106A18-3PX-958](#) [97-3106A18-3PY-958](#) [TV06RL-13-35AD](#) [TV06RL-13-98BD](#) [TV06RW-25-46AE](#)
[TV06RL-13-35SD-LC](#) [TV06RL-13-35SD](#) [TV06RL-13-98SD-LC](#) [TV06RL-13-98SD](#) [TVP00RW-23-53AD](#) [PT02E10-2PW-025](#) [100-007-213-](#)
[002-001](#) [2M805-002-16NF23-12PA](#) [97-3108B16S-5PW-417](#) [97-3108B16S-5PY-417](#) [CS-DSDMDB37MF-025](#) [97-3108B16S-5PZ-417](#)
[PT06SE2041P](#) [CF-5A9013-04N](#) [CF-6A4615-06N](#) [GTC02R32-17S-025-RDS-LC](#) [GTC02R32-17S-025-LC](#) [PT06SE-24-61P\(LC\)](#) [SP28W1F](#)
[TV07DT-25-37P](#) [TV07DT-25-37JN-LC](#) [TV07DT-25-37S](#) [TV07DT-25-37S-LC](#) [TV07DT-25-46P-LC](#) [97-3101A20-21P-958](#) [TV07DT-25-](#)
[90P-LC](#) [TV07DT-25-46A](#) [TV07DT-25-37P-LC](#) [GTS08-36-22PZ-025-B30](#) [PT00SP2241P](#) [LJT06RT-15-35PB\(023\)](#) [TV06RW-23-53AB](#)
[LJT06RT-15-68PB-023](#) [97-3106A-22-9S\(621\)](#) [PT06A14-4S-005](#) [TVS07RF-15-19BB](#)