

RIB-CAGE™

1.27mm (0.050in.) Pitch Board-to-Board Connector System for Extreme Applications

OVERVIEW

Rib-Cage™ connectors provide optimal precision and reliability at a competitive commercial cost.

Rib-Cage™ connectors meet high performance standards for use in applications with shock and vibration.

The versatile Rib-Cage™ system includes dual-row, pin-and-socket connectors for right-angle and mezzanine connections between printed circuit boards (PCB) or flexible printed circuits (FPC).



FEATURES & BENEFITS

- Exclusive Rib-Cage™ multi-point, gold plated receptacle contacts provide optimal reliability in high vibration and shock-prone applications
- MIL-STD-202 Method 204
- IEC 60512 Test 6d
- High density 1.27mm (.050in.) x 1.27mm (.050in.) double row contact grid occupies only 20% of the volume of comparable .100in. pitch systems
- Multiple stack height options offer flexibility for mezzanine connection designs
- Polarization prevents mis-mating
- Multiple PCB positioning and PCB attachment options suit customer assembly requirements
- Available sizes: 10 through 100 total positions
- Lead-free, RoHS compatible plating satisfies environmental regulations

TARGET MARKETS/APPLICATIONS

- Handheld test and diagnostic equipment
- Outdoor test and measurement devices
- Military communications equipment
- Security systems and access control
- Point-of-sale terminals
- Electronic sub-assemblies used in conjunction with fans, motors and mechanical devices

VERTICAL HEADER WITH SURFACE-MOUNT ATTACHMENT

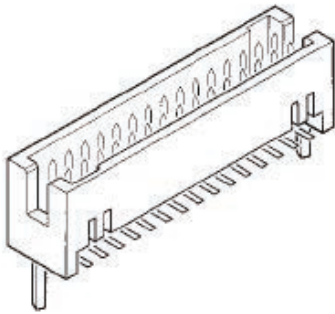

Base number specifies surface-mount vertical shrouded header configuration

Dash number specifies contact finish (1 = 0.76µm (30µin.) gold or GXT) and number of positions per row (5 through 50 increments of 5)

BASE PART NUMBER

Connector Height = DIM.P

Optional feature:	mm	in.	mm	in.	mm	in.
Plain locators	5.74	0.226	7.57	0.298	9.25	0.364
	87849		93221		73546	
	87409		90098		73547	

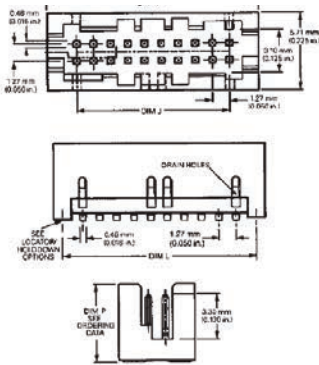

Note 1 – Refer to composite drawing 95781 for availability of tape packaging.
 Note 2 – Locators are the same as those indicated in the SMT receptacle section.

Dash Number	Size	L		J		K	
		mm	in.	mm	in.	mm	in.
105	2 x 5	8.13	0.320	5.08	0.200	9.45	0.372
110	2 x 10	14.48	0.570	11.43	0.450	15.80	0.622
115	2 x 15	20.83	0.820	17.78	0.700	22.15	0.872
120	2 x 20	27.18	1.070	24.13	0.950	28.50	1.122
125	2 x 25	33.53	1.320	30.48	1.200	34.85	1.372
130	2 x 30	39.88	1.570	36.83	1.450	41.20	1.622
135	2 x 35	46.23	1.820	43.18	1.700	47.55	1.872
140	2 x 40	52.58	2.070	49.53	1.950	53.90	2.122
145	2 x 45	58.93	2.320	55.88	2.200	60.25	2.372
150	2 x 50	65.28	2.570	62.23	2.450	66.60	2.622

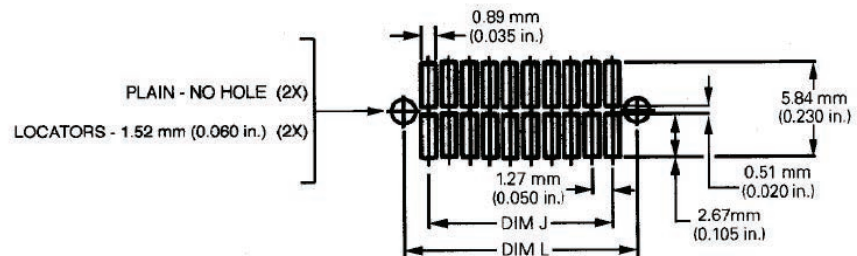

RIGHT-ANGLE HEADER WITH THROUGH-HOLE ATTACHMENT

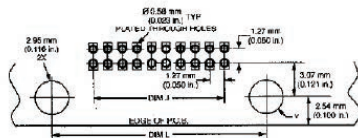
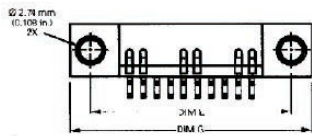
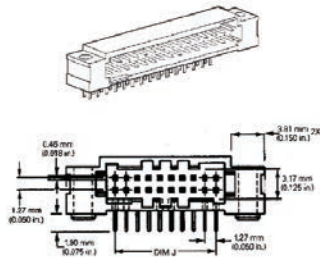

45° TYP

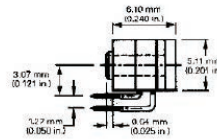
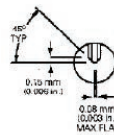

87402

1XX

LF

Lead-free indicator

Base number specifies through-hole, right angle shrouded header configuration

Dash number specifies contact finish (1 = 0.76µm (30µin.) gold or GXT) and number of positions per row (5 through 50 increments of 5)

BASE PART NUMBER

Dash Number	Size	G		J		L	
		mm	in.	mm	in.	mm	in.
105	2 x 5	6.13	0.635	5.08	0.200	12.35	0.485
110	2 x 10	22.48	0.885	11.43	0.450	18.67	0.735
115	2 x 15	28.83	1.135	17.78	0.700	25.02	0.985
135	2 x 35	54.23	2.135	43.18	1.700	50.42	1.985
140	2 x 40	60.58	2.385	49.53	1.950	56.77	2.235
145	2 x 45	66.93	2.635	55.88	2.200	63.12	2.485
150	2 x 50	73.28	2.885	62.23	2.450	69.47	2.735

Additional information can be found at www.fci.com/ribcage

VERTICAL RECEPTACLE WITH SURFACE-MOUNT

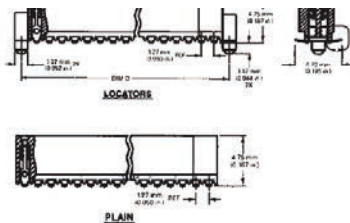
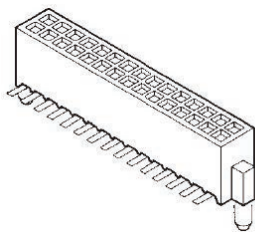

6XX

LF

Lead-free indicator

Base number specifies surface-mount vertical receptacle configuration

Dash number specifies contact finish (6 = 0.76µm (30µin.) gold or GXT) and number of positions per row (5 through 50 increments of 5)

Optional Features	Non-Polarized	Polarized
Plain	87021	87022
Locators	87023	87024

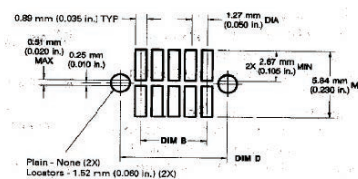

VERTICAL RECEPTACLE WITH SURFACE-MOUNT

BASE PART NUMBER

Note 1 – Refer to product drawing for availability of tape and reel packaging.

Dash Number	Size	A		B		C		D	
		mm	in.	mm	in.	mm	in.	mm	in.
605	2 x 5	6.756	0.266	5.080	0.200	9.398	0.370	8.128	0.320
610	2 x 10	13.106	0.516	11.430	0.450	15.748	0.620	14.478	0.570
615	2 x 15	19.456	0.766	17.780	0.700	22.098	0.870	20.828	0.820
620	2 x 20	25.806	1.016	24.130	0.950	28.448	1.120	27.178	1.070
625	2 x 25	32.156	1.266	30.480	1.200	34.798	1.370	33.528	1.320
630	2 x 30	38.506	1.516	36.830	1.450	41.148	1.620	39.878	1.570
635	2 x 35	44.856	1.766	43.180	1.700	47.498	1.870	46.228	1.820
640	2 x 40	51.206	2.016	49.530	1.950	53.848	2.120	52.578	2.070
645	2 x 45	57.556	2.266	55.880	2.200	60.198	2.370	58.928	2.320
650	2 x 50	63.906	2.516	62.230	2.450	66.548	2.620	65.278	2.570

STACK HEIGHT GUIDANCE

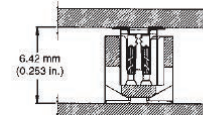

SURFACE-MOUNT RECEPTACLE TO 5.74 mm (0.226 in.) TALL SURFACE-MOUNT HEADER

Surface-Mount Header 5.7mm (0.226 in)

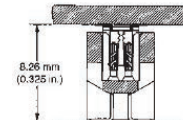

SURFACE-MOUNT RECEPTACLE TO 7.57 mm (0.298 in.) TALL SURFACE-MOUNT HEADER

Surface-Mount Header 7.57mm (0.298 in)

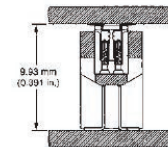

SURFACE-MOUNT RECEPTACLE TO 9.25 mm (0.364 in.) TALL SURFACE-MOUNT HEADER

Surface-Mount Header 9.25mm (0.364 in)

TECHNICAL INFORMATION

MATERIALS

- Housing: Glass-filled thermoplastic, UL94V-0, black or natural color; Temperature range: -55°C to 130°C
- Contact base metal, PCB receptacles: Copper alloy, high spring
- Contact base metal, PCB pin headers: Phosphor bronze
- Contact plating: 30µ (0.76µm) gold/GXT over nickel in contact area; 100µ (2.54µm) lead-free pure tin over nickel on solder tails

ELECTRICAL PERFORMANCE

- Contact resistance (LLCR): 20mΩ max. initial; 25mΩ max. after environmental test
- Current rating: 1.0A DC per contact with all contacts energized (30°C Temp. Rise)
- Insulation resistance: 50,000MΩ min. initial
- Withstanding voltage: 800V AC, RMS at 60Hz
- Capacitance: 1.0pf max. between pairs of adjacent or opposing contacts, un-mated connector

MECHANICAL PERFORMANCE

- Mating force: 157g (5.5oz.) max. per contact
- Unmating force: 43g (1.5oz.) min. per contact
- Contact durability: 200 mating cycles
- Shock and vibration: Per MIL-STD-202 Method 204 and IEC 60512 Test 6d
 - Shock: 50g 11ms half sine
 - Vibration: +/- 20g, 10 to 2000Hz

SPECIFICATIONS

- Product specification: BUS-12-087
- Application specification: BUS-20-052
- Application drawing: TA-901

APPROVALS AND CERTIFICATIONS

- Antistatic tubes or tape and reel / pick-up caps. Packaging options vary by part number. Consult print on website and verify with FCI.

X-ON Electronics

Largest Supplier of Electrical and Electronic Components

Click to view similar products for [Headers & Wire Housings](#) category:

Click to view products by [Amphenol](#) manufacturer:

Other Similar products are found below :

[892-18-020-10-001101](#) [58102-G61-06LF](#) [582553-1](#) [0009485154](#) [009176003701906](#) [0050291907](#) [LY20-4P-DT1-P1E-BR](#) [02.125.8002.8](#)
[609-3404](#) [61062-3](#) [622-0430](#) [622-3653LF](#) [63453-116](#) [636-1030](#) [636-1427](#) [636-3427](#) [636-4007](#) [641938-9](#) [641991-4](#) [644827-2](#) [65817-010LF](#)
[65817-015LF](#) [65863-015LF](#) [66207-023LF](#) [67095-007LF](#) [67601157](#) [68648-049](#) [70.362.1628.0](#) [70-4210](#) [70-4226B](#) [70-4853B](#) [707-5020](#) [707-5028](#) [71.350.2428.0](#) [71918-208LF](#) [71961-016LF](#) [733-134](#) [733-162](#) [754199-000](#) [760-3052](#) [787-8014-00](#) [79531-3000](#) [FCN-360C032-B](#) [FCN-367T-T012/H](#) [FCN-723D010/2](#) [80.063.4001.1](#) [800-90-001-10-001000](#) [800-90-010-10-002000](#) [801-43-002-10-013000](#) [801-43-006-10-002000](#)