

# MMCX

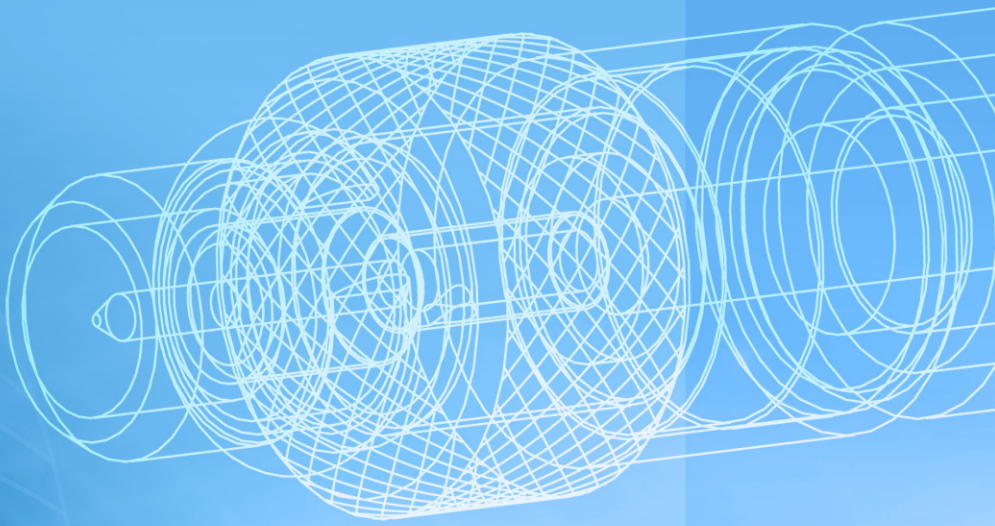

**MMCX Connectors**

# Micro-Mate™ (MMCX) Connectors

## Description

MMCX (also called MicroMate™), is a micro-miniature connector series with a snap-lock mechanism allowing for 360 degrees rotation enabling flexibility in PCB layouts. MMCX connectors conform to the European CECC 22000 specification. The MicroMate Family of products is a 6 GHz 50 Ω interconnect system. A range of connectors is available including surface mount, edge card, and cable connectors.

## Features/Benefits

- Broadband performance with low reflection DC to 6 GHz
- Quick connect/disconnect snap-on mating reduces installation time
- Conforms to European CECC 22000 specifications
- Available in straight and right angle plugs and printed circuit board connectors

## Applications

- Antennas
- Cable Assemblies
- Instrumentation
- Satcom
- Base Stations
- Components
- PCMCIA Cards
- Telecom
- Broadband Communications
- GPS
- Radio Boards

## MMCX Specifications

<b>Electrical</b>		<b>CECC 22000</b>
Impedance	50 Ω	
Frequency range	DC - 6 GHz	
VSWR	1.15 max. @ DC - 4 GHz 1.40 max. @ 4 - 6 GHz	4.4.1
RF-leakage	60 dB minimum 1 GHz (flexible cable) 70 dB minimum 1 GHz (semi-rigid cable)	4.4.8
Voltage rating (at sea level)	≤ 170 Vrms (depending on cable)	
Contact resistance	center contact: ≤ 10 mΩ outer contact: ≤ 5 mΩ	4.4.2 4.4.3
Insulation resistance	1,000 MΩ minimum	4.4.4
Dielectric withstanding voltage	500 Vrms (at sea level)	4.4.5

<b>Mechanical</b>		
Mating	Snap-on coupling	
Contact Captivation	2.3 lbs	4.5.2
Engagement force	≤ 3.4 lbs (15N)	4.5.4
Disengagement force	≥ 1.4 lbs (6N)	4.5.4
Durability (matings)	500 cycles minimum	4.7.1

<b>Environmental</b>		
Temperature range	-55°C to +155°C	4.6.5
Thermal shock	MIL-STD-202, method 107, cond. F	4.6.7
Moisture resistance	MIL-STD-202, method 106	4.6.6
Corrosion	MIL-STD-202, method 101, cond. B	4.6.10
Vibration	3 cycles, 3 opposite directions, 10 - 150 Hz, 10 - 60 Hz: 0.75mm / 0.03 in., 60 - 150 Hz: 10 G	4.6.3
Mechanical shock	MIL-STD-202, method 213, cond. B	4.6.4
Humidity	MIL-STD-202, method 103, cond. B	4.6.6

<b>Material</b>		
Body and outer contacts	Brass, nickel or gold plated	
Male contact	Brass, gold plated	
Female contact	Beryllium copper or phosphor bronze, gold plated	
Crimp ferrule	Copper or brass, nickel plated	
Insulator	LCP, PTFE or PFA	

### Plug

### Jack

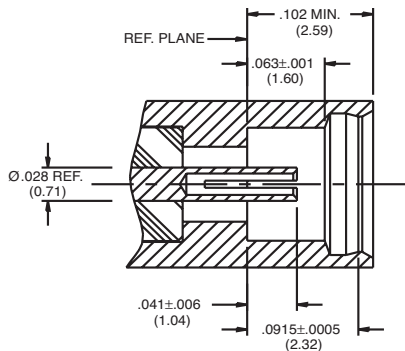
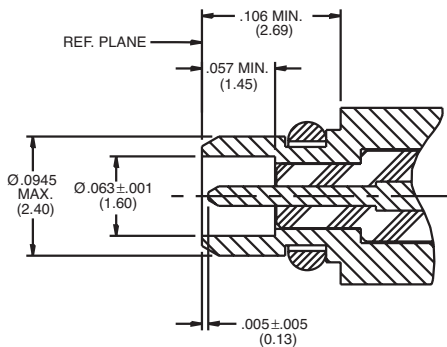

## Cable Connectors

### Straight Plugs



Cable Group	Part Number	Plating	Termination	
		Body and Contact	Body	Contact
A	908-41200	Gold	Crimp	Solder
B	908-41300	Gold	Crimp	Solder
B2	908-41500	Gold	Crimp	Solder
L2	908-41400	Gold	Solder	Solder
L4	908-41600	Gold	Solder	Solder

### Angle Plugs

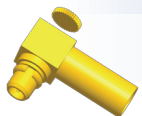

Cable Group	Part Number	Plating	Termination	
		Body and Contact	Body	Contact
A	908-43200	Gold	Crimp	Solder
B	908-43300	Gold	Crimp	Solder
B2	908-43500	Gold	Crimp	Solder
L2	908-43400	Gold	Solder	Solder
L4	908-43600	Gold	Solder	Solder

### Straight Jacks



Cable Group	Part Number	Plating	Termination	
		Body and Contact	Body	Contact
B	908-42300	Gold	Crimp	Solder
B2	908-42500	Gold	Crimp	Solder

## Printed Circuit Board Connectors

### Straight Plugs



Part Number	Plating Body and Contact	Description
908-21103	Gold	Thru-Hole

### Straight Jacks



Part Number	Plating Body and Contact	Description
908-22106	Gold	Thru-Hole
908-22109	Gold	Surface Mount

### Angle Jacks

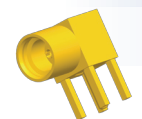

Part Number	Plating Body and Contact	Description
908-24100	Gold	Thru-Hole

## Edge Mount Plugs

Part Number	Plating Body and Contact	Description
908-21100	Gold	
908-21100T	Gold	Tape & Reel, 1500 per reel
908-21102	Gold	Offset

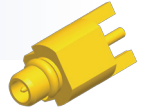

## Edge Mount Jacks

Part Number	Plating Body and Contact	Description
908-22100	Gold	
908-22100T	Gold	Tape & Reel, 1500 per reel
908-22103	Gold	Offset



## Surface Mount Jacks

Part Number	Plating Body and Contact	Insulator	Cap	Description
908-22101	Gold	LCP	-	Single Packed
908-22101B	Gold	LCP	-	Bulk Packed, 100 per bag
908-22101T	Gold	LCP	-	Tape & Reel, 1500 per reel
908-22101-TC	Gold	LCP	LCP	Tape & Reel, 1500 per reel

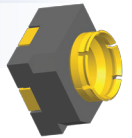

Cable Group	Cable Type
A	RG-178, 196
B	RG-174, 188A, 316, Belden 7805
B1	RG-179, 187, Belden 9221
B2	RD-188/U, RD-316/U
B3	RD-179/U, AT&T 19224L2
C	RG-58, 58A, 58C, 141, 303, LMR195, Belden 7806A, 9907
C1	RG-55, 142, 223, 400
C2	LMR200, Belden 7807A
D	RG-58/U Plenum, Thinnet, RG-122/U, Belden 88240, 89907
E	RG-59, 62, 140, 210, Belden 8241, 8263, 8279, 9209
E1	RG-59/U 20 AWG center conductor, Belden 1426A, 1505A, 9100, 9278
E2	RD-59/U, Belden 8281, 9141, 9231
E3	RG-59/U Quad Shield, Belden 1152A
F	RG-59/U Plenum, Belden 1560A, 9259, 82259, 89259, 88241
F1	RG-59/U Plenum 20 AWG center conductor, Belden 82108
G1	RG-6, 143, 212
G2	8X, LMR240, Belden 7808A, 9258
G3	LMR400, Belden 7810A, 8214, 9913
G4	RG-8, 8A, 9, 87A, 213, 214, 225, 393
G5	RD-6/U
H	RG-11
H1	Belden 1694A, 9248
H2	Belden 1859A, 7731, 8213, 9292
H3	RG-54A/U
I	AT&T 734A, Belden 1505A
I2	AT&T 735A, Belden 735A1
J	Quad 59 headend cable
K	LMR600
K2	Belden 1695A
K3	RG-122, 180, 195, Belden 1855, 1865A, 8218
L	.141 semi-rigid, RG-402/U
L2	.085, .086, .087 semi-rigid, RG-405/U
L3	.250 semi-rigid
L4	.047 semi-rigid, Belden 1674
M	1/2 inch annular corrugated
M1	1 1/4 inch annular corrugated
M2	1 5/8 inch annular corrugated
M3	7/8 inch annular corrugated
N	1/4 Helical
N1	3/8 Helical
N2	1/2 Helical
N3	7/8 inch SFC
P1	.81 mm OD micro-cable
P2	1.13 mm OD micro-cable, TCB-068
P3	1.32 mm OD micro-cable
P4	1.37 mm OD micro-cable

## X-ON Electronics

Largest Supplier of Electrical and Electronic Components

*Click to view similar products for [RF Connectors / Coaxial Connectors](#) category:*

*Click to view products by [Amphenol](#) manufacturer:*

Other Similar products are found below :

[8915-1511-000](#) [89674-0827](#) [6001-7071-019](#) [6002-7051-003](#) [6002-7551-202](#) [6059674-1](#) [619550-1](#) [630059-000](#) [M39030/3-01N](#) [M3933/25-36N](#) [6500-7071-046](#) [6769](#) [CX050L2AQ](#) [7002-1542-011](#) [7004-1512-000](#) [7009-1511-004](#) [7010-1511-000](#) [7029-1511-060](#) [7101-1541-010](#) [7101-1571-002](#) [7105-1521-002](#) [7145-1521-002](#) [7203-1571-003](#) [7209-1511-011](#) [7210-1511-015](#) [7210-1511-019](#) [73137-5015](#) [73216-2241](#) [7325-1512-000](#) [73404-2300](#) [7405-1521-005](#) [7405-1521-802](#) [7406-1521-005](#) [8527](#) [8547](#) [FS11V](#) [8808-1511-001](#) [9049-9513-000](#) [9074-9513-000](#) [9101-9573-002](#) [910A205F](#) [9130-9573-002](#) [PL11SC-026](#) [PL375-33](#) [PL40-5](#) [PL71-9](#) [PL74C-221](#) [PL75MC-217](#) [PL803-7](#) [980-8666-005](#)