

PRODUCT NUMBER
95000-XXXXLF

PLATING ————
 ———— RoHS COMPATIBLE, SEE NOTE 6
 ———— PACKAGING TYPE, NOTE 3
 ———— TOTAL NB OF POSITIONS, 3 TO 17

- 0 = 0.20µm GOLD/GXT ON CONTACT AREA
2.0µm MIN MATTE TIN ON TAILS
- 1 = 0.76µm GOLD/GXT ON CONTACT AREA
2.0µm MIN MATTE TIN ON TAILS
- 3 = 0.38µm GOLD/GXT ON CONTACT AREA
2.0µm MIN MATTE TIN ON TAILS
- T = FULL MATTE TIN 2µm-5µm
1.27µm Ni MIN UNDERPLATING

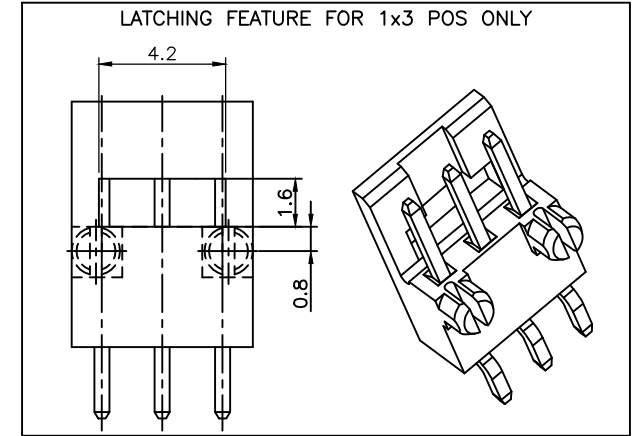
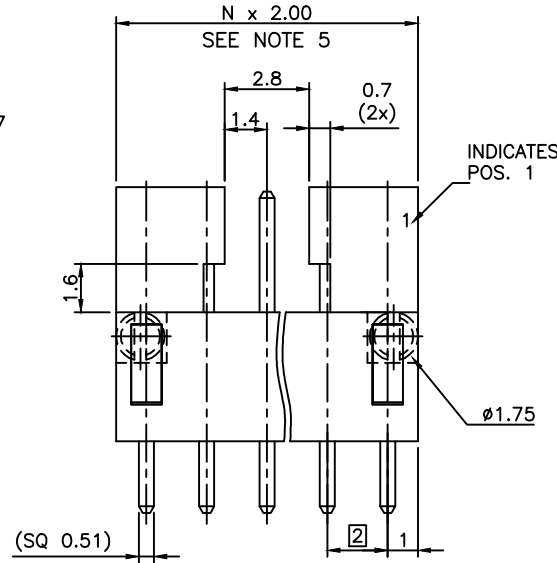

NOTES:

- 1 - HOUSING MAT'L : HIGH TEMPERATURE THERMOPLASTIC. UL94V-0 COLOR: CREAM
- 2 - PIN MATERIAL : COPPER ALLOY
- 3 - PACKAGING :
= POLY BAGS
T = TUBE, FROM 04 POS UP TO 17 POS
TR = TAPE & REEL AS AVAILABLE.
- 4 - 7N MIN RETENTION IN EITHER DIRECTION
- 5 - TO DETERMINE DIMENSIONS :
N = NUMBER OF POSITIONS
- 6 - RoHS COMPATIBLE PRODUCT SPECIFICATIONS

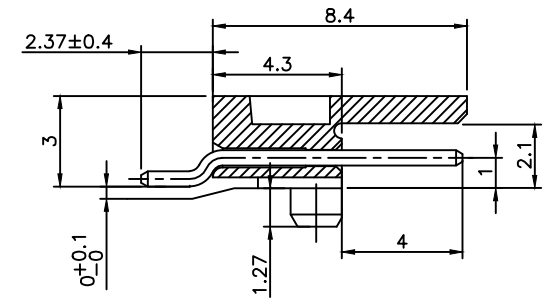
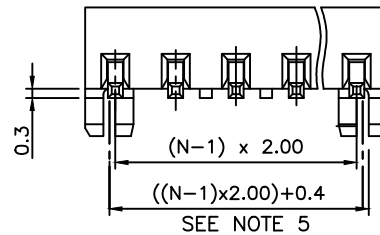

- a - MANUFACTURING PROCESS COMPATIBILITY
- THE HOUSING WILL WITHSTAND EXPOSURE TO 260°C PEAK TEMPERATURE FOR 30 SECONDES MAX IN A CONVECTION, INFRA-RED OR VAPOR PHASE OR REFLOW OVEN.
- b - LABELLING:
- MEETS PACKAGING SPECS AS PER GS-14-920
- c - THIS PRODUCT MEETS EUROPEAN DIRECTIVES AND OTHER COUNTRY REGULATIONS AS DISCRIBED IN GS-47-0004
- 7 - HOLE DIMENSION TO BE ø1.60±0.07 FOR INTERFERENCE FIT APPLICATIONS, SEE SHEET 2.
HOLE DIMENSION TO BE ø1.95±0.07 FOR NON INTERFERENCE FIT (LOCATIONAL) APPLICATIONS

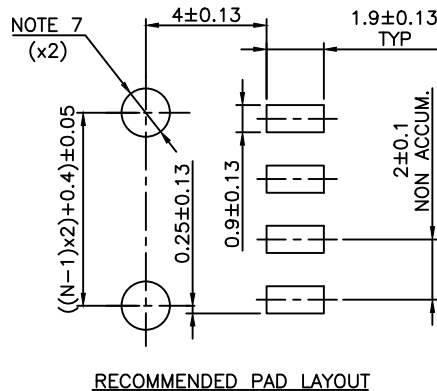

mat'l. code		surface		tolerance		projection		product family	
		ISO 1302 ✓		ISO 406 ISO 1101		mm		MINITEK	
ltr		ecn no dr date		tolerances unless otherwise specified		mm		title	
S		B-19986 JCO 15.01.13		angles		.x ±0.3		MINITEK SMT HDR SR	
T		B-19995 JCO 15.01.15		linear		.xx ±0.13		POLARIZATION & LATCHING	
U		F-23052 AMA 16.01.15		±z		xxx ±0.05		scale 7:1	
		dr		J. FABRE		13.01.07		dwg no	
N		B-15804 JCO 13.08.28		enrg		J. FABRE 13.01.07		sheet 1 of 2	
P		B-16822 JCO 14.01.23		chr		JL CORDIER 13.01.07		size	
R		B-19187 LMU 14.10.24		appd		JMC 13.01.07		95000 A3	
sheet		revision		U A		FCJ		type	
index		sheet		1 2				CUSTOMER Drawing	

RECOMMENDATION TO PLACE THE CONNECTOR ONTO THE PCB

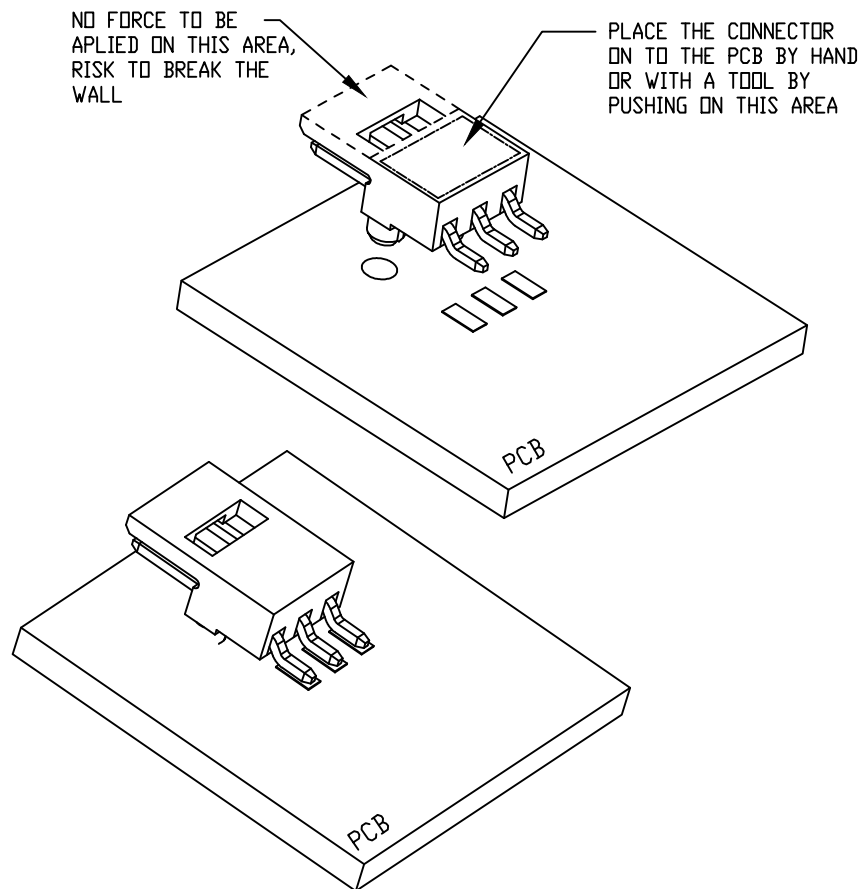
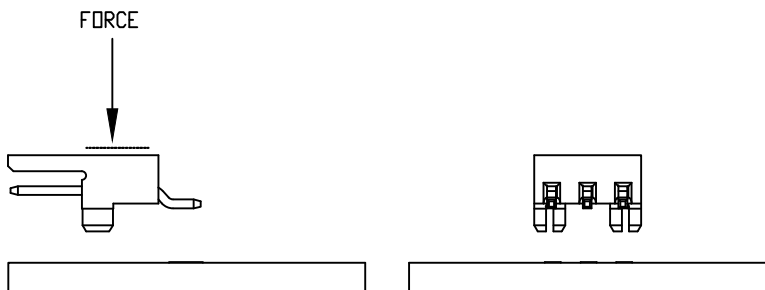
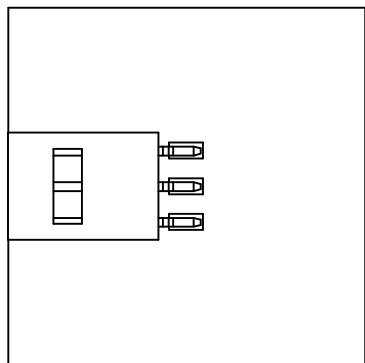

Copyright FCI

mat'l. code		surface		tolerance		projection		product family	
N/A		ISO 1302 ✓		ISO 406 ISO 1101				MINITEK	
ltr ecn no dr date		tolerances unless otherwise specified						title	
A	B-19986	J.FA	15.01.13	angles	linear	mm		MINITEK SMT HDR SR	
				0°±x'		scale 1:1		POLARIZATION & LATCHING	
		dr	J.FABRE	15.01.07				dwg no	
		enr	L.MULIN	15.01.07	sheet of 2				
		chr	J.COMPAGNON	15.01.12	95000				
		appd	JCO	15.01.13			type		Product Customer Drawing
sheet index	revision sheet								

X-ON Electronics

Largest Supplier of Electrical and Electronic Components

Click to view similar products for [Headers & Wire Housings](#) category:

Click to view products by [Amphenol](#) manufacturer:

Other Similar products are found below :

[892-18-020-10-001101](#) [58102-G61-06LF](#) [582553-1](#) [0009485154](#) [009176003701906](#) [0050291907](#) [LY20-4P-DT1-P1E-BR](#) [02.125.8002.8](#)
[609-3404](#) [61062-3](#) [622-0430](#) [622-3653LF](#) [63453-116](#) [636-1030](#) [636-1427](#) [636-3427](#) [636-4007](#) [641938-9](#) [641991-4](#) [644827-2](#) [65817-010LF](#)
[65817-015LF](#) [65863-015LF](#) [66207-023LF](#) [67095-007LF](#) [67601157](#) [68648-049](#) [70.362.1628.0](#) [70-4210](#) [70-4226B](#) [70-4853B](#) [707-5020](#) [707-](#)
[5028](#) [71.350.2428.0](#) [71918-208LF](#) [71961-016LF](#) [733-134](#) [733-162](#) [754199-000](#) [760-3052](#) [787-8014-00](#) [79531-3000](#) [FCN-360C032-B](#) [FCN-](#)
[367T-T012/H](#) [FCN-723D010/2](#) [80.063.4001.1](#) [800-90-001-10-001000](#) [800-90-010-10-002000](#) [801-43-002-10-013000](#) [801-43-006-10-002000](#)