

## Accessories Index

• Cable	
T-Cable .....	21-1
Y-Cable	
.....	21-3
• Adaptor	
T-Adaptor .....	21-4
Y-Adaptor	
.....	21-6
I-Adaptor .....	21-7
• Cap	
Dust Cap .....	21-9
Waterproof Cap	
.....	21-11
Dummy	
.....	21-18
• Multi-port	
Multi-port	
.....	21-19
• Box	
Box .....	21-21
• Tool	
Wrench	
.....	21-22
Unlock Tool	
.....	21-22

# Accessories - Cable

## ➤ T-Cable > Circular > Standard Size: 5/8"-27 UNS

■ Customized – Upon Request

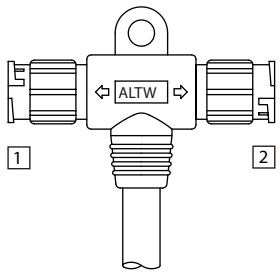

5 For connector 1  
6 For connector 2

Choose Connector / Contacts Gender:  
M: Male + Male  
F: Female + Female  
H: Male + Female  
B: Female + Male

\* Choose the cable length:01-99 m / PVC UL2464 Cable

Current Rating	Contacts 2	Mating Style	Connector 1 (Male Connector / Male Contacts)	Connector 1 (Female Connector / Female Contacts)	More options
			Connector 2 (Male Connector / Male Contacts)	Connector 2 (Female Connector / Female Contacts)	
10A	02,03,04	Screw Thread	BA-2-2-00-MM0-TSA*	BA-2-2-00-FF0-TSA*	BA-2-2-00-5-6-0-TSA*
		2 point lock bayonet	BA-2-2-00-MM0-TLA*	BA-2-2-00-FF0-TLA*	BA-2-2-00-5-6-0-TLA*
5A	02,03,04,05,06,07,08	Screw Thread	BA-2-2-00-MM0-TSA*	BA-2-2-00-FF0-TSA*	BA-2-2-00-5-6-0-TSA*
		2 point lock bayonet	BA-2-2-00-MM0-TLA*	BA-2-2-00-FF0-TLA*	BA-2-2-00-5-6-0-TLA*
2A	10,12	Screw Thread	BA-2-2-00-MM0-TSA*	BA-2-2-00-FF0-TSA*	BA-2-2-00-5-6-0-TSA*
		2 point lock bayonet	BA-2-2-00-MM0-TLA*	BA-2-2-00-FF0-TLA*	BA-2-2-00-5-6-0-TLA*

## ➤ T-Cable > Circular > Other Size > Mix Size (10A+5A)

■ Customized – Upon Request

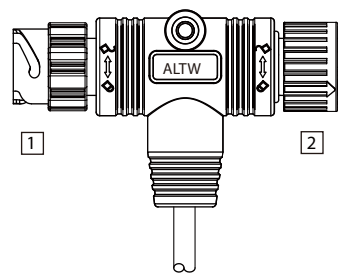

\* Choose the cable length:01-99 m / PVC UL2464 Cable

Current Rating	Contacts	Mating Style	Connector 1 (Male Connector / Male Contacts)	Connector 1 (Female Connector / Female Contacts)	Connector 1 (Male Connector / Male Contacts)
			Connector 2 (Male Connector / Male Contacts)	Connector 2 (Female Connector / Female Contacts)	Connector 2 (Female Connector / Female Contacts)
5A	08	Screw Thread	GA-080800-MM0-TSA*	GA-080800-FF0-TSA*	GA-080800-MF0-TSA*

➤ T-Cable > M Series Sensor > M12

■ Customized – Upon Request

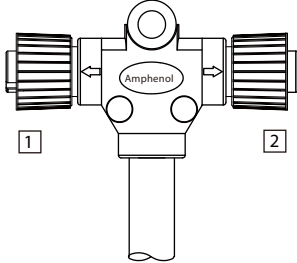

Choose Connector / Contacts Gender:

- 6 For connector 1
- 7 For connector 2

A/B/D Code  
M: Male + Male  
F: Female + Female  
I Style  
K: Connector (Male) + Contact (Male+Female)  
Z: Connector (Female) + Contact (Male+Female)

\* Choose the cable length: 01-99 m / PVC UL2464 Cable

Type	Current Rating	Contacts 2	Mating Style	Connector 1 (Male Connector / Male Contacts)	Connector 1 (Female Connector / Female Contacts)	More options	
				Connector 2 (Male Connector / Male Contacts)	Connector 2 (Female Connector / Female Contacts)		
M12	A Code	4A	03,04,05	Screw Thread	SS- 2 2 00-MM0-TSA*	SS- 2 2 00-FF0-TSA*	SS- 2 2 00- 6 7 0-TSA*
		2A	08		SS-080800-MM0-TSA*	SS-080800-FF0-TSA*	SS-080800- 6 7 0-TSA*
	B Code	4A	04,05		SB- 2 2 00-MM0-TSA*	SB- 2 2 00-FF0-TSA*	SB- 2 2 00- 6 7 0-TSA*
	D Code	4A	04,05		SD- 2 2 00-MM0-TSA*	SD- 2 2 00-FF0-TSA*	SD- 2 2 00- 6 7 0-TSA*
	I Style	4A	05		SI-050500-KK0-TSA*	SI-050500-ZZ0-TSA*	SI-050500- 6 7 0-TSA*
M12 (Plastic)	A Code	4A	03,04,05	Screw Thread	PS- 2 2 00-MM0-TSA*	PS- 2 2 00-FF0-TSA*	PS- 2 2 00- 6 7 0-TSA*
		2A	08		PS-080800-MM0-TSA*	PS-080800-FF0-TSA*	PS-080800- 6 7 0-TSA*
	B Code	4A	04,05		PB- 2 2 00-MM0-TSA*	PB- 2 2 00-FF0-TSA*	PB- 2 2 00- 6 7 0-TSA*
	D Code	4A	04,05		PD- 2 2 00-MM0-TSA*	PD- 2 2 00-FF0-TSA*	PD- 2 2 00- 6 7 0-TSA*
	I Style	4A	05		PI-050500-KK0-TSA*	PI-050500-ZZ0-TSA*	PI-050500- 6 7 0-TSA*

\* Design and specification are subject to change without notice.

Y-Cable > M Series Sensor > M12

■ Customized – Upon Request

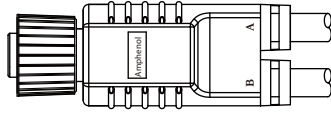

\* Choose the cable length:01-99 m / PU VW-1Cable

Type		Current Rating	Contacts ②	Mating Style	Connector (Male Connector / Male Contacts)	Connector (Female Connector / Female Contacts)
M12	A Code	4A	03,04,05	Screw Thread	SS- ② 0000-M00-YSB*	SS- ② 0000-F00-YSB*
		2A	08	Screw Thread	SS-080000-M00-YSB*	SS-080000-F00-YSB*
	B Code	4A	04,05	Screw Thread	SB- ② 0000-M00-YSB*	SB- ② 0000-F00-YSB*
	D Code	4A	04,05	Screw Thread	SD- ② 0000-M00-YSB*	SD- ② 0000-F00-YSB*
	I Style	4A	05	Screw Thread	SI-050000-K00-YSB*	SI-050000-Z00-YSB*

# Accessories - Adaptor

## ↳ T-Adaptor > Circular > Mini Size: 7/16"-28 UNS

Customized – Upon Request

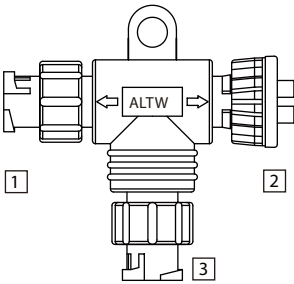

5 For connector 1  
6 For connector 2  
7 For connector 3

Choose Connector / Contacts Gender:  
M: Male + Male  
F: Female + Female

Current Rating	Contacts 2	Mating Style	Connector 1 (Male Connector / Male Contacts)	Connector 1 (Female Connector / Female Contacts)	More options
			Connector 2 (Male Connector / Male Contacts)	Connector 2 (Female Connector / Female Contacts)	
			Connector 3 (Male Connector / Male Contacts)	Connector 3 (Female Connector / Female Contacts)	
5A	02,03	Screw Thread	AA-2 2 2 -MMM-TS001	AA-2 2 2 -FFF-TS001	AA-2 2 2 -5 6 7 -TS001
		2 point lock bayonet	AA-2 2 2 -MMM-TL001	AA-2 2 2 -FFF-TL001	AA-2 2 2 -5 6 7 -TL001
2A	04,05,06	Screw Thread	AA-2 2 2 -MMM-TS001	AA-2 2 2 -FFF-TS001	AA-2 2 2 -5 6 7 -TS001
		2 point lock bayonet	AA-2 2 2 -MMM-TL001	AA-2 2 2 -FFF-TL001	AA-2 2 2 -5 6 7 -TL001

## ↳ T-Adaptor > Circular > Standard Size: 5/8"-27 UNS

Customized – Upon Request

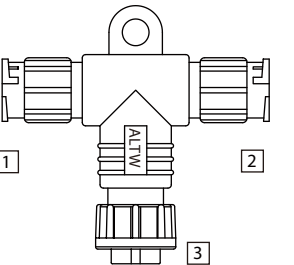

5 For connector 1  
6 For connector 2  
7 For connector 3

Choose Connector / Contacts Gender:  
M: Male + Male  
F: Female + Female  
H: Male + Female  
B: Female + Male

\* Choose the cable length:01-99 m /  
PVC UL2464 Cable

Current Rating	Contacts 2	Mating Style	Connector 1 (Male Connector / Male Contacts)	Connector 1 (Female Connector / Female Contacts)	More options
			Connector 2 (Male Connector / Male Contacts)	Connector 2 (Female Connector / Female Contacts)	
			Connector 3 (Male Connector / Male Contacts)	Connector 3 (Female Connector / Female Contacts)	
5A	02,03,04, 05,06,07, 08	Screw Thread	BA-2 2 2 -MMM-TS001	BA-2 2 2 -FFF-TS001	BA-2 2 2 -5 6 7 -TS001
		2 point lock bayonet	BA-2 2 2 -MMM-TL001	BA-2 2 2 -FFF-TL001	BA-2 2 2 -5 6 7 -TL001
2A	10,12	Screw Thread	BA-2 2 2 -MMM-TS001	BA-2 2 2 -FFF-TS001	BA-2 2 2 -5 6 7 -TS001
		2 point lock bayonet	BA-2 2 2 -MMM-TL001	BA-2 2 2 -FFF-TL001	BA-2 2 2 -5 6 7 -TL001

\* Design and specification are subject to change without notice.

↳ T-Adaptor > M Series Sensor > M12

Customized – Upon Request

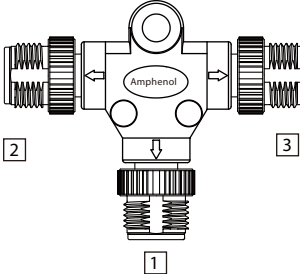

Choose Connector / Contacts Gender:

- 5 For connector 1
- 6 For connector 2
- 7 For connector 3

A/B/D Code  
M: Male + Male  
F: Female + Female  
I Style  
K: Connector (Male) + Contact (Male+Female)  
Z: Connector (Female) + Contact (Male+Female)

Type	Current Rating	Contacts 2	Mating Style	Connector 1 (Male Connector / Male Contacts)	Connector 1 (Female Connector / Female Contacts)	More options	
				Connector 2 (Male Connector / Male Contacts)	Connector 2 (Female Connector / Female Contacts)		
				Connector 3 (Male Connector / Male Contacts)	Connector 3 (Female Connector / Female Contacts)		
M12	A Code	4A	03,04,05	Screw Thread	SS- 2 2 2 -MMM-TS001	SS- 2 2 2 -FFF-TS001	SS- 2 2 2 -5 6 7-TS001
		2A	08	Screw Thread	SS-080808-MMM-TS001	SS-080808-FFF-TS001	SS-080808- 5 6 7-TS001
	B Code	4A	04,05	Screw Thread	SB- 2 2 2 -MMM-TS001	SB- 2 2 2 -FFF-TS001	SB- 2 2 2 -5 6 7-TS001
	D Code	4A	04,05	Screw Thread	SD- 2 2 2 -MMM-TS001	SD- 2 2 2 -FFF-TS001	SD- 2 2 2 -5 6 7-TS001
	I Style	4A	05	Screw Thread	SI-050505-KKK-TS001	SI-050505-ZZZ-TS001	SI-050505- 5 6 7-TS001
M12 (Plastic)	A Code	4A	03,04,05	Screw Thread	PS- 2 2 2 -MMM-TS001	PS- 2 2 2 -FFF-TS001	PS- 2 2 2 -5 6 7-TS001
		2A	08	Screw Thread	PS-080808-MMM-TS001	PS-080808-FFF-TS001	PS-080808- 5 6 7-TS001
	B Code	4A	04,05	Screw Thread	PB- 2 2 2 -MMM-TS001	PB- 2 2 2 -FFF-TS001	PB- 2 2 2 -5 6 7-TS001
	D Code	4A	04,05	Screw Thread	PD- 2 2 2 -MMM-TS001	PD- 2 2 2 -FFF-TS001	PD- 2 2 2 -5 6 7-TS001
	I Style	4A	05	Screw Thread	PI-050505-KKK-TS001	PI-050505-ZZZ-TS001	PI-050505- 5 6 7-TS001

Y-Adaptor > M Series Sensor > M12

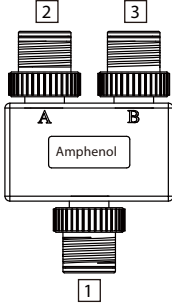
		Customized – Upon Request				Choose Connector / Contacts Gender:	
Type	Current Rating	Contacts 2	Mating Style	Connector 1 (Male Connector / Male Contacts)	Connector 1 (Female Connector / Female Contacts)	More options	
				Connector 2 (Male Connector / Male Contacts)	Connector 2 (Female Connector / Female Contacts)		
				Connector 3 (Male Connector / Male Contacts)	Connector 3 (Female Connector / Female Contacts)		
M12	A Code	4A	03,04,05	Screw Thread	SS-222-MMM-YS001	SS-222-FFF-YS001	SS-222-567-YS001
		2A	08	Screw Thread	SS-080808-MMM-YS001	SS-080808-FFF-YS001	SS-080808-567-YS001
	B Code	4A	04,05	Screw Thread	SB-222-MMM-YS001	SB-222-FFF-YS001	SB-222-567-YS001
	D Code	4A	04,05	Screw Thread	SD-222-MMM-YS001	SD-222-FFF-YS001	SD-222-567-YS001
	I Style	4A	05	Screw Thread	SI-050505-KKK-YS001	SI-050505-ZZZ-YS001	SI-050505-567-YS001
M12 (Plastic)	A Code	4A	03,04,05	Screw Thread	PS-222-MMM-YS001	PS-222-FFF-YS001	PS-222-567-YS001
		2A	08	Screw Thread	PS-080808-MMM-YS001	PS-080808-FFF-YS001	PS-080808-567-YS001
	B Code	4A	04,05	Screw Thread	PB-222-MMM-YS001	PB-222-FFF-YS001	PB-222-567-YS001
	D Code	4A	04,05	Screw Thread	PD-222-MMM-YS001	PD-222-FFF-YS001	PD-222-567-YS001
	I Style	4A	05	Screw Thread	PI-050505-KKK-YS001	PI-050505-ZZZ-YS001	PI-050505-567-YS001

\* Design and specification are subject to change without notice.

∨ I-Adaptor > Circular > Mini Size: 7/16"-28 UNS

■ Customized – Upon Request

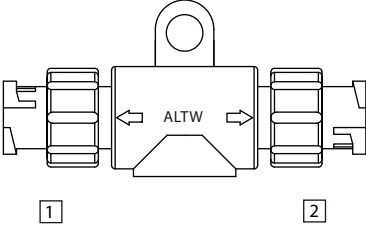

6 For connector 1  
7 For connector 2

Choose Connector / Contacts Gender:  
M: Male + Male  
F: Female + Female

Current Rating	Contacts 3	Mating Style	Connector 1 (Male Connector / Male Contacts)	Connector 1 (Female Connector / Female Contacts)	More options
			Connector 2 (Male Connector / Male Contacts)	Connector 2 (Female Connector / Female Contacts)	
5A	02,03	Screw Thread	AA-00 3 3 -0MM-IS001	AA-00 3 3 -0FF-IS001	AA-00 3 3 -0 6 7 IS001
		2 point lock bayonet	AA-00 3 3 -0MM-IL001	AA-00 3 3 -0FF-IL001	AA-00 3 3 -0 6 7 IL001
2A	04,05,06	Screw Thread	AA-00 3 3 -0MM-IS001	AA-00 3 3 -0FF-IS001	AA-00 3 3 -0 6 7 IS001
		2 point lock bayonet	AA-00 3 3 -0MM-IL001	AA-00 3 3 -0FF-IL001	AA-00 3 3 -0 6 7 IL001

∨ I-Adaptor > Circular > Standard Size: 5/8"-27 UNS

■ Customized – Upon Request

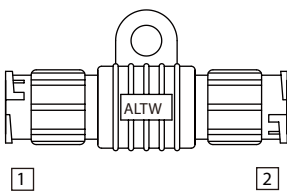

6 For connector 1  
7 For connector 2

Choose Connector / Contacts Gender:  
M: Male + Male  
F: Female + Female  
H: Male + Female  
B: Female + Male

Current Rating	Contacts 3	Mating Style	Connector 1 (Male Connector / Male Contacts)	Connector 1 (Female Connector / Female Contacts)	More options
			Connector 2 (Male Connector / Male Contacts)	Connector 2 (Female Connector / Female Contacts)	
5A	02,03,04,05,06,07,08	Screw Thread	BA-00 3 3 -0MM-IS001	BA-00 3 3 -0FF-IS001	BA-00 3 3 -0 6 7 IS001
		2 point lock bayonet	BA-00 3 3 -0MM-IL001	BA-00 3 3 -0FF-IL001	BA-00 3 3 -0 6 7 IL001
2A	10,12	Screw Thread	BA-00 3 3 -0MM-IS001	BA-00 3 3 -0FF-IS001	BA-00 3 3 -0 6 7 IS001
		2 point lock bayonet	BA-00 3 3 -0MM-IL001	BA-00 3 3 -0FF-IL001	BA-00 3 3 -0 6 7 IL001



└ I-Adaptor > Circular > Other Size > Mix Size (10A+5A)

■ Customized – Upon Request

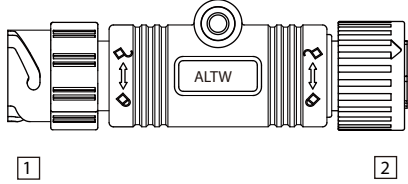

Current Rating	Contacts	Mating Style	Connector 1 (Male Connector / Male Contacts)	Connector 1 (Female Connector / Female Contacts)	Connector 1 (Female Connector / Female Contacts)
			Connector 2 (Male Connector / Male Contacts)	Connector 2 (Female Connector / Female Contacts)	Connector 1 (Male Connector / Male Contacts)
5A	08	3 point lock bayonet	GA-000808-0MM-IT001	GA-000808-OFF-IT001	GA-000808-0FM-IT001

└ I-Adaptor > M Series Sensor > M12

■ Customized – Upon Request

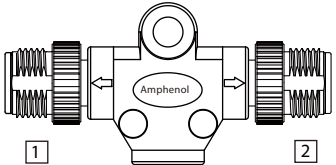

Choose Connector / Contacts Gender:

- 6 For connector 1
- 7 For connector 2

A/B/D Code  
M: Male + Male  
F: Female + Female  
I Style  
K: Connector (Male) + Contact (Male+Female)  
Z: Connector (Female) + Contact (Male+Female)

\* M12

Type	Current Rating	Contacts 3	Mating Style	Connector 1 (Male Connector / Male Contacts)	Connector 1 (Female Connector / Female Contacts)	More options	
				Connector 2 (Male Connector / Male Contacts)	Connector 2 (Female Connector / Female Contacts)		
M12	A Code	4A	03,04,05	Screw Thread	SS-00 3 3 -0MM-IS001	SS-00 3 3 -OFF-IS001	SS-00 3 3 -0 6 7 IS001
		2A	08	Screw Thread	SS-000808-0MM-IS001	SS-000808-OFF-IS001	SS-000808-0 6 7 IS001
	B Code	4A	04,05	Screw Thread	SB-00 3 3 -0MM-IS001	SB-00 3 3 -OFF-IS001	SB-00 3 3 -0 6 7 IS001
	D Code	4A	04,05	Screw Thread	SD-00 3 3 -0MM-IS001	SD-00 3 3 -OFF-IS001	SD-00 3 3 -0 6 7 IS001
	I Style	4A	05	Screw Thread	SI-000505-0KK-IS001	SI-000505-0ZZ-IS001	SI-000505-0KZ-IS001 SI-000505-0ZK-IS001
M12 (Plastic)	A Code	4A	03,04,05	Screw Thread	PS-00 3 3 -0MM-IS001	PS-00 3 3 -OFF-IS001	PS-00 3 3 -0 6 7 IS001
		2A	08	Screw Thread	PS-000808-0MM-IS001	PS-000808-OFF-IS001	PS-000808-0 6 7 IS001
	B Code	4A	04,05	Screw Thread	PB-00 3 3 -0MM-IS001	PB-00 3 3 -OFF-IS001	PB-00 3 3 -0 6 7 IS001
	D Code	4A	04,05	Screw Thread	PD-00 3 3 -0MM-IS001	PD-00 3 3 -OFF-IS001	PD-00 3 3 -0 6 7 IS001
	I Style	4A	05	Screw Thread	PI-000505-0KK-IS001	PI-000505-0ZZ-IS001	PI-000505-0KZ-IS001 PI-000505-0ZK-IS001

\* Design and specification are subject to change without notice.

# Accessories - Cap

## ∟ Dust Cap > Circular

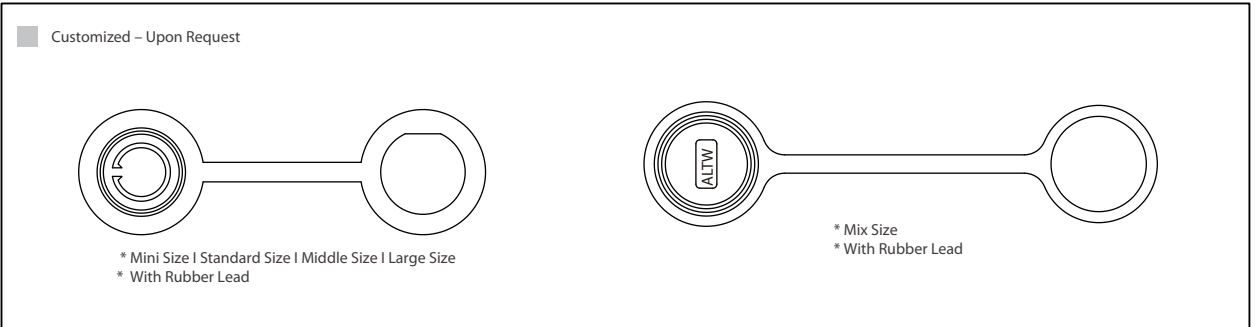

Size	Mating Pair	Mating Pair (Gender)	P/N
Mini Size 7/16"-28 UNS	Receptacle	Male	CAP-DAAMDPC1
Standard Size 5/8"-27 UNS	Receptacle	Male	CAP-DABMDPC1 CAP-DABMDPC2 CAP-DABMDPC3
		Female	-
	Overmolded with Cable	Male	CAP-DABMDCC1 CAP-DABMDCC2
		Female	CAP-DABFDCC1
Middle Size 13/16"-28 UNS	Receptacle	Male	CAP-DACMDPC1 CAP-DACMDPC2
	Overmolded with Cable	Female	CAP-DACFDCC1
Large Size 1"-20 UNEF	Receptacle	Male	CAP-DADMDPC1
Mix Size 12-5A	Receptacle	Male	CAP-DPLMDPC1

▾ Dust Cap > D-SUB > Standard & High Density

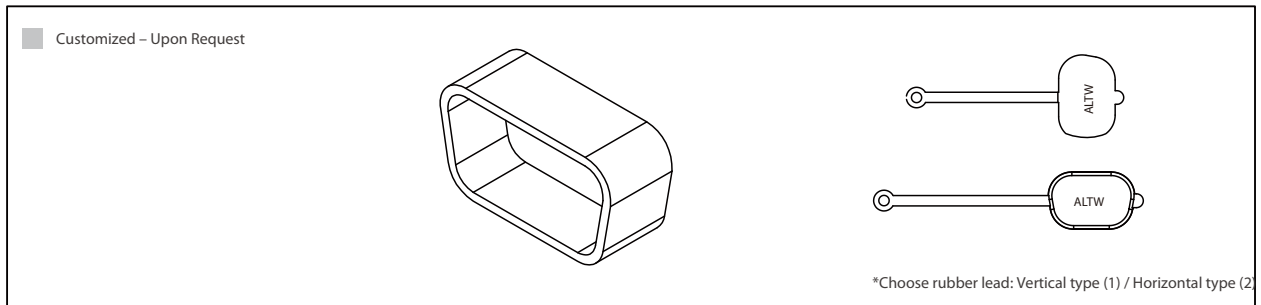

Type		Mating Pairs	Mating Pair (Gender)	P/N
Standard D-SUB	High Density D-SUB			
Standard (9 pins)	High Density (15 Pins)	Receptacle (With horizontal rubber lead)	Male	CAP-DD1MDPC2
		Receptacle and Overmolded with Cable (With horizontal / Vertical rubber lead)		CAP-DD1MDMA1
		Receptacle	Female	CAP-DD1FDPC1* CAP-DD1FDPC2*
		Receptacle and Overmolded with Cable		CAP-DD1FDMA1
Standard (15 pins)	High Density (26 Pins)	Receptacle and Overmolded with Cable	Male	CAP-DD2MDMA1
		Receptacle and Overmolded with Cable	Female	CAP-DD2FDMA1
Standard (25 pins)	High Density (44 Pins)	Receptacle and Overmolded with Cable	Male	CAP-DD3MDMA1
		Receptacle (With horizontal rubber lead)	Female	CAP-DD3FDPC1
		Receptacle and Overmolded with Cable		CAP-DD3FDMA1

\* Design and specification are subject to change without notice.

Waterproof Cap > Circular

Customized – Upon Request

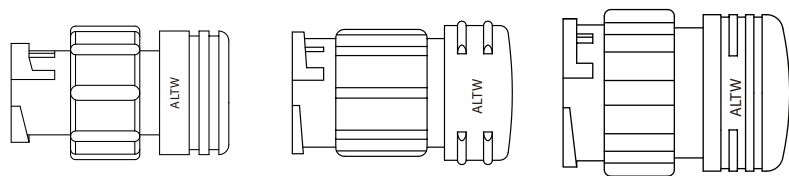

Choose Connector / Contacts Gender:

- 6 More to choose: None(A) / With Chain(B) / With Rubber Lead(C) / With Fish Line(D)
- 7 \* Mini Size: Choose 2 contacts(1) / 3 contacts(3) / 4~6 contacts(2) for male mating pair
- \* Standard Size: Choose 12 contacts (2) for male mating pair
- \* Middle Size: Choose plastic(1) or metal(2) items

Size	Mating Pair	Mating Style	Mating Pair (Gender)	P/N	
Mini Size 7/16"-28 UNS	Receptacle	Screw Thread	Male	CAP-WAAMSP <sup>6</sup> 1	
		2 point lock bayonet	Male	CAP-WAAML <sup>6</sup> 7	
			Female	CAP-WAAFLP <sup>6</sup> 7	
	Overmolded with Cable	Screw Thread	Male	CAP-WAAMSMA1	
		2 point lock bayonet	Male	CAP-WAAMLMA <sup>7</sup>	
			Female	CAP-WAAF <sup>7</sup> MA	
	Receptacle and Overmolded with Cable	Screw Thread	Male	CAP-WAAMSMA1	
		2 point lock bayonet	Male	CAP-WAAMLMA <sup>7</sup>	
			Female	CAP-WAAFLMA <sup>7</sup>	
	Standard Size 5/8"-27 UNS	Receptacle	Screw Thread	Male	CAP-WABMSP <sup>6</sup> 1
			2 point lock bayonet	Female	CAP-WABFSP <sup>6</sup> 1
				Male	CAP-WABMLP <sup>6</sup> 7
Overmolded with Cable		2 point lock bayonet	Female	CAP-WABFLP <sup>6</sup> 7	
			Male	CAP-WABMSMA1	
		Screw Thread	Female	CAP-WABFSMA1	
Receptacle and Overmolded with Cable		2 point lock bayonet	Male	CAP-WABMLMA <sup>7</sup>	
			Female	CAP-WABFLMA <sup>7</sup>	
		Screw Thread	Male	CAP-WABMSMA1	
Middle Size 13/16"-28 UNS		Receptacle	Screw Thread	Female	CAP-WABFSMA1
			2 point lock bayonet	Male	CAP-WABMLMA <sup>7</sup>
				Female	CAP-WABFLMA <sup>7</sup>
	Overmolded with Cable	Screw Thread	Male	CAP-WABMSMA1	
		2 point lock bayonet	Male	CAP-WACMLP <sup>6</sup> 1	
			Female	CAP-WACFLP <sup>6</sup> 1	
	Receptacle and Overmolded with Cable	Screw Thread	Male	CAP-WACMSMA <sup>7</sup>	
		2 point lock bayonet	Male	CAP-WACMLMA1	
			Female	CAP-WACFLMA1	
		Screw Thread	Male	CAP-WACMSMA <sup>7</sup>	
			Female	CAP-WACFLMA1	
		Screw Thread	Male	CAP-WACMSMA <sup>7</sup>	
2 point lock bayonet	Male	CAP-WACMLMA1			
	Female	CAP-WACFLMA1			

Waterproof Cap >Circular

Customized – Upon Request

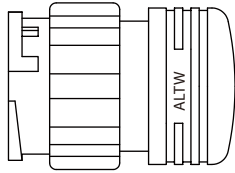

\* Large Size

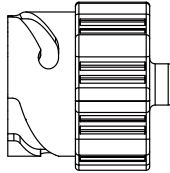

\* Mix Size

6 More to choose: None(A) / With Chain(B) / With Rubber Lead(C) / With Fish Line(D)

7 \* Large Size: Choose 18 contacts(2) for female mating pair

Size	Mating Pair	Mating Style	Mating Pair (Gender)	P/N
Large Size 1"-20 UNEF	Receptacle	Screw Thread	Male	CAP-WADMSP 6 1
		2 point lock bayonet	Male	CAP-WADMLP 6 7
	Female		CAP-WADFLP 6 7	
	Overmolded with Cable	Screw Thread	-	-
		2 point lock bayonet	-	-
	Receptacle and Overmolded with Cable	Screw Thread	Male	CAP-WADMSMA1
2 point lock bayonet		Male	CAP-WADMLMA 7	
	Female	CAP-WADFLMA 7		
Mix Size (Between Standard & Middle Size)	Receptacle	3 Points Lock	Male	CAP-WEBMLP 6 1
			Female	CAP-WEBFLP 6 1
	Receptacle and Overmolded with Cable	3 Points Lock	Male	CAP-WEBMLMA1
			Female	CAP-WEBFLMA1

\* Design and specification are subject to change without notice.

Waterproof Cap > Power

Customized – Upon Request

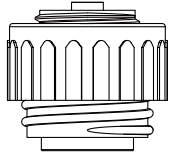

\* 8A (PWE) | 12A (PWF) | 16A (PWG)

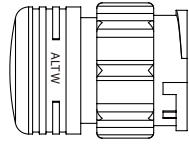

\* 20A (PWC) | 20A+2A (PWCU)

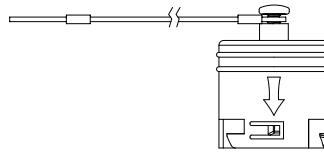

\* 25A (PWH) | 30A (PWJ)

6 More to choose: None(A) / With Chain(B) / With Rubber Lead(C) / With Fish Line(D)

Current Rating	Mating Pair	Mating Style	Mating Pair (Gender)	P/N
8A(PWE)	Receptacle	Screw Thread	Male	CAP-WTAMSP 6 1
	Receptacle and Overmolded with Cable		Female	CAP-WTAFSP 6 1
			Male	CAP-WTAM5MA1
			Female	CAP-WTAF5MA1
12A(PWF)	Receptacle	Screw Thread	Male	CAP-WTAMSP 6 1
	Receptacle and Overmolded with Cable		Female	CAP-WTAFSP 6 1
			Male	CAP-WTAM5MA1
			Female	CAP-WTAF5MA1
16A(PWG)	Receptacle	Screw Thread	Male	CAP-WTAMSP 6 1
	Receptacle and Overmolded with Cable		Female	CAP-WTAFSP 6 1
			Male	CAP-WTAM5MA1
			Female	CAP-WTAF5MA1
20A(PWC)	Receptacle	2 point lock bayonet	Male	CAP-WACMLP 6 1
	Receptacle and Overmolded with Cable		Female	CAP-WACFLMA2
	Receptacle and Overmolded with Cable		Male	CAP-WACMLMA1
20A+2A(PWCU)	Receptacle	2 point lock bayonet	Male	CAP-WACMLP 6 1
	Receptacle and Overmolded with Cable		Female	CAP-WACFLMA2
	Receptacle and Overmolded with Cable		Male	CAP-WACMLMA1
25A(PWH)	Receptacle and Overmolded with Cable	3 point lock bayonet	Female	CAP-WPWFTMD1
30A(PWJ)	Receptacle and Overmolded with Cable	3 point lock bayonet	Male	CAP-WPWTMD1

Waterproof Cap > Sensor > M8

■ Customized – Upon Request

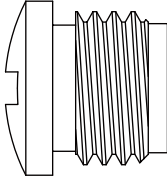

For Female

Size	Mating Pair	Mating Style	Mating Pair (Gender)	P/N
M8	Overmolded with Cable	Screw Thread	Female	CAP-WBBFSCC1
	Receptacle and Overmolded with Cable	Screw Thread	Male	CAP-WBBMSMA1
			Female	CAP-WBBFSMA1

Waterproof Cap > Sensor > M10.5

■ Customized – Upon Request

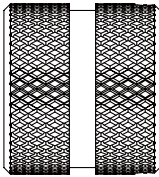

For male

Size	Mating Pair	Mating Style	Mating Pair (Gender)	P/N
M10.5	Receptacle and Overmolded with Cable	Screw Thread	Male	CAP-WBCMSMA2

\* Design and specification are subject to change without notice.

Waterproof Cap > Sensor > M12

Customized – Upon Request

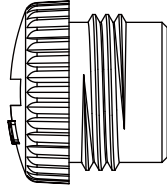

\* For Female

7 Choose plastic(1) or metal(2) items

Size	Size	Mating Pair	Mating Style	Mating Pair (Gender)	P/N
M12	A/B/D Code I Style	Receptacle	Screw Thread	Male	CAP-WBDPMSB1
		Receptacle and Overmolded with Cable	Screw Thread	Male	CAP-WBDMMSMA 7
				Female	CAP-WBDFSMA 7
M12(Plastic)	A/B/D Code I Style	Receptacle and Overmolded with Cable	Screw Thread	Male	CAP-WBDMMSMA 7
				Female	CAP-WBDFSMA 7

Waterproof Cap > Sensor > Heavy Duty Shielded Connectors

Customized – Upon Request

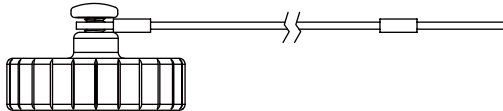

Size	Mating Pair	Mating Style	Mating Pair (Gender)	P/N
M22	Receptacle	Screw Thread	Male	CAP-WHBMSPD1

Waterproof Cap > Sensor > M23

Customized – Upon Request

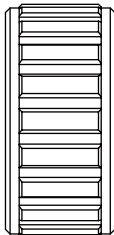

Size	Mating Pair	Mating Style	Mating Pair (Gender)	P/N
M23	Receptacle and Overmolded with Cable	Screw Thread	Male	CAP-WBHMSMA1



## Waterproof Cap > USB | IEEE 1394

■ Customized – Upon Request

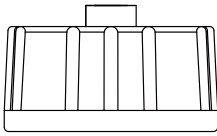

\* USB Screw (Mating Pair: Male)

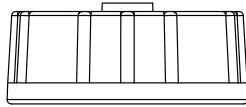

\* USB Lock

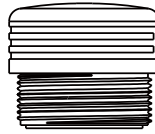

\* USB Screw (Mating Pair: Female)

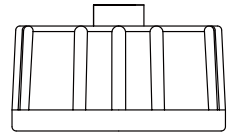

\* IEEE 1394

⑥ More to choose: None(A) / With Chain(B) / With Rubber Lead(C) / With Fish Line(D)

Type	Mating Pair	Mating Style	Mating Pair (Gender)	P/N
USB 2.0 Type A USB 2.0 Type B USB 3.0 Type A	Receptacle	Screw Thread	Male	CAP-WACMSP ⑥ 1
		2 point lock bayonet	Male	CAP-WADMLP ⑥ 1
	Receptacle and Overmolded with Cable	Screw Thread	Male	CAP-WACMSMA1
		2 point lock bayonet	Male	CAP-WADMLMA1
	Overmolded with Cable	Screw Thread	Female	CAP-WUSFSCC1
IEEE 1394	Receptacle	Screw Thread	Male	CAP-WACMSP ⑥ 1
	Receptacle and Overmolded with Cable	Screw Thread	Male	CAP-WACMSMA1

## Waterproof Cap > D-SUB | DVI

■ Customized – Upon Request

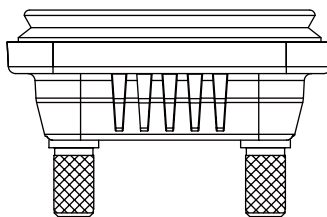

⑦ Choose rubber lead: Vertical type (1) / Horizontal type (2)

Type		Mating Pairs	Mating Style	Mating Pair (Gender)	P/N
Standard D-SUB	High Density D-SUB				
Standard (9 pins)	High Density (15 Pins)	Receptacle	Screw Thread	Male & Female	CAP-WD1CSPA1
Standard (15 pins)	High Density (26 Pins)	Receptacle	Screw Thread	Male & Female	CAP-WD2CSPA1
Standard (25 pins)	High Density (44 Pins)	Receptacle	Screw Thread	Male & Female	CAP-WD3CSPA1
DVI		Receptacle	Screw Thread	Male & Female	CAP-WDVCSPA1

\* Design and specification are subject to change without notice.

Waterproof Cap > RJ

■ Customized – Upon Request

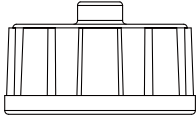

\* RJ C 3 Point Lock

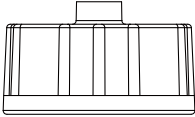

\* RJ C Screw

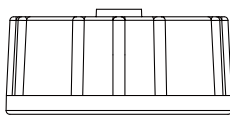

\* RJ D Screw

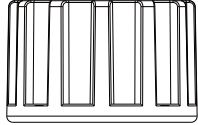

\* RJ ODVA 3 Point Lock

6 More to choose: None(A) / With Chain(B) / With Rubber Lead(C) / With Fish Line(D)  
7 Choose plastic (1) or metal (2) items

Size	Mating Pair	Mating Style	Mating Pair (Gender)	P/N
C Size	Receptacle	3 point lock bayonet	Male	CAP-WACMTMA1 CAP-WACMTP <span style="color: blue;">6</span> 1
		Screw Thread	Male	CAP-WACMSMA <span style="color: blue;">7</span> CAP-WACMSP <span style="color: blue;">6</span> <span style="color: blue;">7</span>
D Size	Receptacle	Screw Thread	Male	CAP-WADMSMA1 CAP-WADMSP <span style="color: blue;">6</span> 1
ODVA	Receptacle	3 point lock bayonet	Male	CAP-WEOFTPC1

Waterproof Cap > HDMI

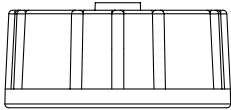

\* D Size (Circular Type)

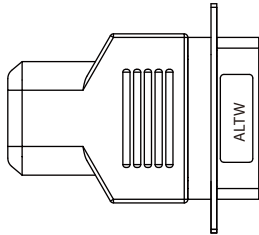

\* Rectangle Type

Size	Mating Pair	Mating Style	Mating Pair (Gender)	P/N
D Size (Circular Type)	Receptacle	Screw Thread	Male	CAP-WADMSMA1
Rectangle Type	Receptacle	Latch Type	Female	CAP-WHDFLPA1

Waterproof Cap > Fiber Optic

Customized – Upon Request

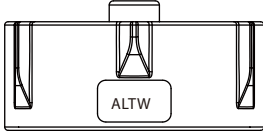

7

Size	Mating Pair	Mating Style	Mating Pair (Gender)	P/N
Fiber Optic	Receptacle and Overmolded with Cable	3 point lock bayonet	Female	CAP-WFBFTMA1

Dummy > Circular > Middle Size: 13/16"-28 UNS

Customized – Upon Request

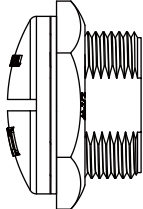

Size	Mating Pair	Mating Style	P/N
13/16"-28 UNS	Receptacle (Female)	Screw Thread	CAP-CACFSBA1

\* Design and specification are subject to change without notice.

# Accessories - Multi-port

## Multi-port > Circular > Mini Size: 7/16"-28 UNS

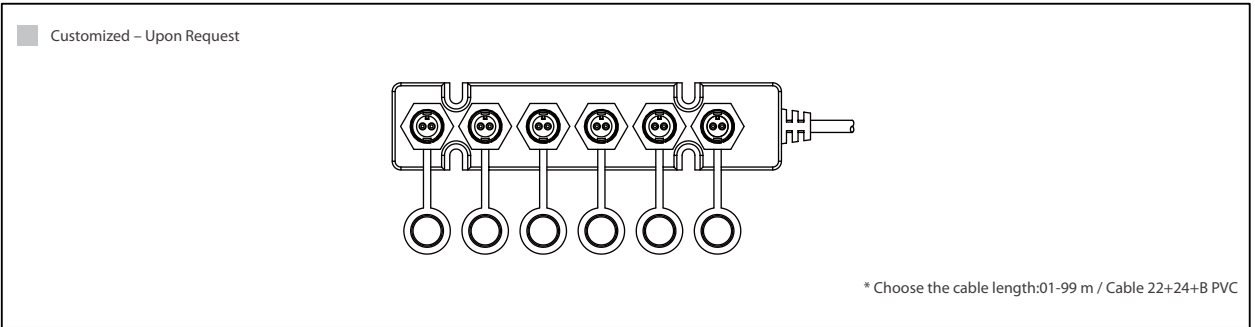

Current Rating	Contacts 2	Mating Style	Connector 1 (Male Connector / Male Contacts)	Connector 1 (Male Connector / Female Contacts)	More options
			Connector 2 (Male Connector / Male Contacts)	Connector 2 (Male Connector / Female Contacts)	
			Connector 3 (Male Connector / Male Contacts)	Connector 3 (Male Connector / Female Contacts)	
			Connector 4 (Male Connector / Male Contacts)	Connector 4 (Male Connector / Female Contacts)	
			Connector 5 (Male Connector / Male Contacts)	Connector 5 (Male Connector / Female Contacts)	
			Connector 6 (Male Connector / Male Contacts)	Connector 6 (Male Connector / Female Contacts)	
5A	02,03	Screw Thread	A-2 2 2 2 2 2 -MMMMMM-SA*	A-2 2 2 2 2 2 -HHHHHH-SA*	A-2 2 2 2 2 -7 8 9 10 11 12 13 -SA*
		2 point lock bayonet	A-2 2 2 2 2 2 -MMMMMM-LA* A-22222-MMMMMM-LA01	A-2 2 2 2 2 2 -HHHHHH-LA*	A-2 2 2 2 2 -7 8 9 10 11 12 13 -LA*
2A	04,05,06	Screw Thread	A-2 2 2 2 2 2 -MMMMMM-SA*	A-2 2 2 2 2 2 -HHHHHH-SA*	A-2 2 2 2 2 -7 8 9 10 11 12 13 -SA*
		2 point lock bayonet	A-2 2 2 2 2 2 -MMMMMM-LA*	A-2 2 2 2 2 2 -HHHHHH-LA*	A-2 2 2 2 2 -7 8 9 10 11 12 13 -LA*

Multi-port > Circular > Standard Size: 5/8"-27 UNS

Customized – Upon Request

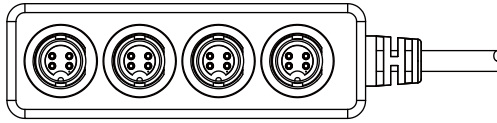

- 6 For connector 1
- 7 For connector 2
- 8 For connector 3
- 9 For connector 4

Choose Connector / Contacts Gender:  
 M: Male + Male  
 F: Female + Female

\* Choose the cable length:01-99 m /  
 Cable 22+24+B PVC

Current Rating	Contacts 2	Mating Style	Connector 1 (Male Connector / Male Contacts)	Connector 1 (Male Connector / Female Contacts)	More options
			Connector 2 (Male Connector / Male Contacts)	Connector 2 (Male Connector / Female Contacts)	
			Connector 3 (Male Connector / Male Contacts)	Connector 3 (Male Connector / Female Contacts)	
			Connector 4 (Male Connector / Male Contacts)	Connector 4 (Male Connector / Female Contacts)	
10A	02,03,04	Screw Thread	B-2 2 2 2 -MMMMMM-SA*	B-2 2 2 2 -HHHHHH-SA*	B-2 2 2 2 -6 7 8 9 -SA*
		2 point lock bayonet	B-2 2 2 2 -MMMMMM-LA*	B-2 2 2 2 -HHHHHH-LA*	B-2 2 2 2 -6 7 8 9 -LA*
5A	02,03,04, 05,06,07, 08	Screw Thread	B-2 2 2 2 -MMMMMM-SA*	B-2 2 2 2 -HHHHHH-SA* B-04040404-HHHH-SA*	B-2 2 2 2 -6 7 8 9 -SA*
		2 point lock bayonet	B-2 2 2 2 -MMMMMM-LA*	B-2 2 2 2 -HHHHHH-LA*	B-2 2 2 2 -6 7 8 9 -LA*
2A	10,12	Screw Thread	B-2 2 2 2 -MMMMMM-SA*	B-2 2 2 2 -HHHHHH-SA*	B-2 2 2 2 -6 7 8 9 -SA*
		2 point lock bayonet	B-2 2 2 2 -MMMMMM-LA*	B-2 2 2 2 -HHHHHH-LA*	B-2 2 2 2 -6 7 8 9 -LA*

\* Design and specification are subject to change without notice.

# Accessories - Box

Box > USB > 2.0 Type A, 2.0 Type B

■ Customized – Upon Request

Type	Ports	P/N
2.0 Type A	1	BOX-USA11
	2	BOX-USA22
	4	BOX-USA44
2.0 Type B	1	BOX-USB11
	2	BOX-USB22
	4	BOX-USB44

## Accessories - Tool

Wrench > Circular > Standard Size:  
5/8"-27 UNS

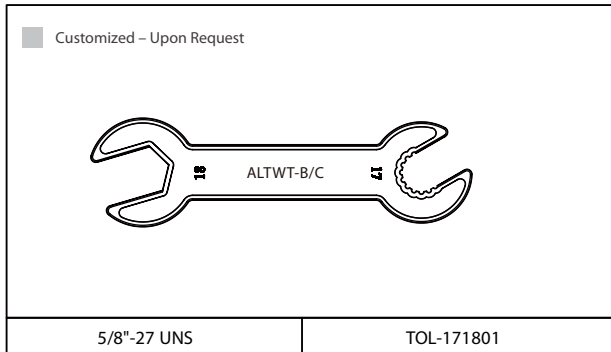

Wrench > Circular > Middle Size:  
13/16"-28 UNS

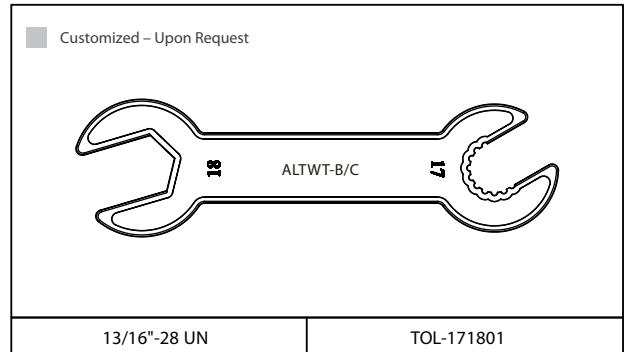

Wrench > Circular > Large Size:  
1"-20 UNEF

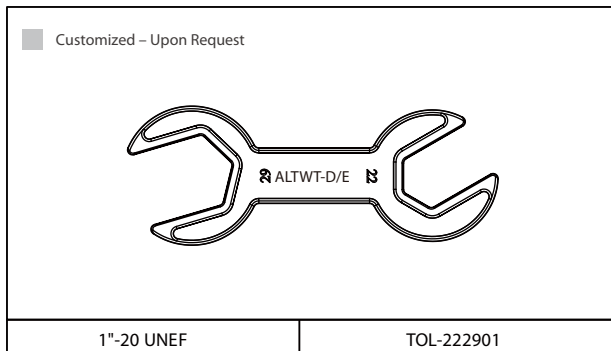

Unlock Tool > Cable Joiner >  
8~10mm/10~12mm/12~16mm

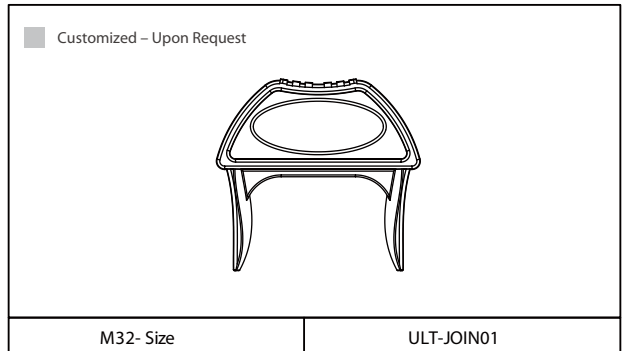

# Accessories - Joint

∟ Joint > D-SUB > Standard & High Density

■ Customized – Upon Request

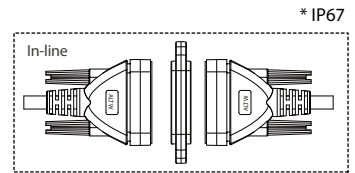
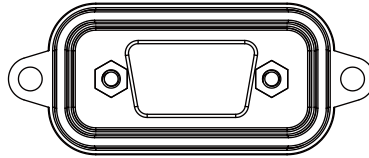

Type		Mating Style	P/N
Standard D-SUB	High Density D-SUB		
Standard (9 pins)	High Density (15 Pins)	Screw Thread	DJ1-00JNNA-SL7001
Standard (15 pins)	High Density (26 Pins)	Screw Thread	DJ2-00JNNA-SL7001
Standard (25 pins)	High Density (44 Pins)	Screw Thread	DJ3-00JNNA-SL7001



# Accessories - Patch Cable (Double-ended)

## ▾ Patch Cable (Double-ended) > RJ

■ Customized – Upon Request

End 2 Pin Header End 1

Plug

Gold Plated 6u"  
Pitch 2.54mm  
Select cable length 10cm/20cm/30cm

End 1		End 2		P/N
Type	Gender	Type	Gender	
RJ 45 Unshielded	Plug	RJ 45 Unshielded	Pin Header	UPG06-CHOP1-C10
			Plug	UPG06-UPG06-C10

\* Design and specification are subject to change without notice.

## X-ON Electronics

Largest Supplier of Electrical and Electronic Components

*Click to view similar products for [Sensor Cables / Actuator Cables](#) category:*

*Click to view products by [Amphenol](#) manufacturer:*

Other Similar products are found below :

[60963](#) [60964](#) [M83513/19-F01CP](#) [703000D02F2002](#) [703001D02F0602](#) [703001D02F300](#) [704000D02F120](#) [773032K02F030](#) [802027107404-1](#)  
[802027213811-1](#) [804001A09M150](#) [805001A09M0502](#) [84914-0235](#) [84914-0237](#) [885030A09M020](#) [8R4J30E03C3003](#) [1200651332](#)  
[1200651713](#) [1200660844](#) [1200660845](#) [1200661173](#) [1200680071](#) [1200720053](#) [1200720081](#) [1200720099](#) [1200720217](#) [1200800231](#)  
[1200860125](#) [1200870123](#) [1200980102](#) [1200650267](#) [1200650298](#) [1200660183](#) [1200660782](#) [1200660849](#) [1200661295](#) [1200661297](#)  
[1200661342](#) [1200661343](#) [1200670080](#) [1200670220](#) [1200680331](#) [1200720252](#) [1200730184](#) [1200860344](#) [1200870359](#) [1200870643](#)  
[1200980008](#) [1200980031](#) [1210502211](#)