

Amphenol MIL-DTL-5015, Matrix[®]



TABLE OF CONTENTS

MIL-DTL-5015, Matrix[®]

- Design Characteristics, Customer Options 433
- Insert Availability and Identification 434, 435
- Insert Arrangement Drawings 436-444
- Class Descriptions, Performance Specifications 445
- Insert Alternate Positioning 446
- How to Order, Military and Commercial 447

Shell Styles:

- Wall mounting receptacle threaded MS3450 (9440) 448
- Cable connecting receptacle threaded MS3451 (9441) 449
- Box mounting receptacle threaded MS3452 (9442) 450
- Jam nut receptacle threaded MS3454 (9444) 451
- Straight plug threaded MS3456 (9446) 452
- Straight plug, self-locking threaded MS3459 (9816) 453
- Quick disconnect plug push-pull coupling (9817/9818) 454
- Matrix[®] 5015 with RADSOK[®] contacts, for high power 455
- Contact information, sealing plugs, tools 456
- Protection caps, dust caps 457-459
- Additional MIL-DTL-5015 connectors offered by Amphenol 460



MIL-DTL-5015, Matrix[®] Typical Markets:

- Military Vehicles
- Heavy Equipment
- Military Aircraft
- Power Generation





MS3450 wall mounting receptacle



MS3451 cable connecting receptacle



MS3452 box mounting receptacle



MS3454 jam nut receptacle



MS3456 plug with threaded coupling



MS3459 plug with self-locking coupling nut

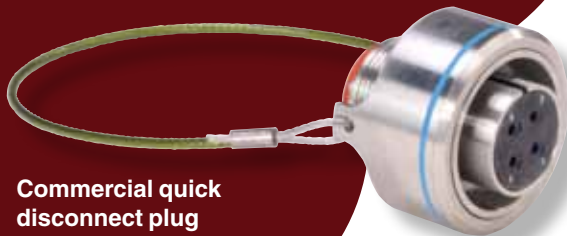

Commercial quick disconnect plug with/without lanyard

Amphenol broadens their MS/Standard family of connectors with the MIL-DTL-5015 Crimp Rear Release Series.

This series provides an alternative to the older MIL-C-5015 solder type. It bridges the gap between an old connector standard and the environmental and high performance needs of current technologies.

DESIGN CHARACTERISTICS

- Medium to heavy weight cylindrical
- MS345() series intermateable with existing MIL-DTL-5015 solder or crimp versions on existing equipment
- Captive coupling nut mechanism, utilizes retaining rings in combination with "L" washers to prevent inadvertent disassembly
- Multiple interlock systems ensure permanent insert retention
- Positive control of dielectric separation with guaranteed ease of contact insertion
- Positive contact retention provided by a closely toleranced damage-proof metal retention clip
- Completely sealed against environmental extremes with -
 - Individual contact seals (conical risers on pin interface)
 - Interfacial seals between contacts
 - Peripheral gasket shell-to-shell seals
 - Redundant rear wire seals and insert-to-shell seals

CUSTOMER OPTIONS

- Seven mounting styles, in shell sizes 8 to 48*
- Threaded coupling or self-locking plug (MS3459) with an internal ratcheting mechanism to prevent unmating due to vibration and shock, eliminating the need for safety wiring
- Proprietary quick disconnect plug, with or without lanyard available
- Classes include aluminum or stainless steel shells, or firewall capability
- MS and Proprietary versions available
- Some styles are supplied to McDonnell Douglas Specification BAN 7025, DC60 Series
- Accommodation of contact sizes 0 to 16
- Over 100 insert arrangement patterns available, accommodating from a minimum of 1 to a maximum of 85 circuits
- Alternate positioning available
- Thermocouple pin and socket contacts are available**

NOTE: MIL-C-5015 is superseded to MIL-DTL-5015 for all Amphenol/Matrix rear release crimp type contacts.

* Consult Amphenol Aerospace for availability of shell sizes 44 and 48.

** Consult Amphenol Aerospace for information on thermocouple contacts.

38999

| |
|-------------|
| III |
| HD |
| Dualok |
| II |
| I |
| SJT |
| Accessories |
| Aquacon |
| Herm/Seal |
| PCB |

| |
|----------------------------|
| HIGH SPEED |
| Fiber Optics |
| Contacts Connectors Cables |

EMI Filter Transient

26482 Matrix 2

83723 III Matrix | Pyle

26500 Pyle

5015 Crimp Rear Release Matrix

22992 Class 1

Back-Shell's

Options Others

38999

- III
- HD
- Dualok
- II
- I
- SJT
- Accessories
- Aquacon
- Herm/Seal
- PCB

- HIGH SPEED
- Fiber Optics
- Contacts Connectors Cables

- EMI Filter Transient

- 26482 Matrix 2

- 83723 III Matrix | Pyle

- 26500 Pyle

- 5015 Crimp Rear Release Matrix

- 22992 Class I

- Back-Shells

- Options Others

| Insert Arrangement | Service Rating | Total Contacts | Contact Size | | | | |
|--------------------|----------------|----------------|--------------|---|---|----|----|
| | | | 0 | 4 | 8 | 12 | 16 |
| 8S-1 | A | 1 | | | | | 1 |
| 10S-2 | A | 1 | | | | | 1 |
| 10SL-3 | A | 3 | | | | | 3 |
| 10SL-4 | A | 2 | | | | | 2 |
| 12S-1 | A | 2 | | | | | 2 |
| 12S-2 | A | 2 | | | | | 2 |
| 12S-3 | A | 2 | | | | | 2 |
| 12S-4 | D | 1 | | | | | 1 |
| 12-5 | D | 1 | | | | 1 | |
| 14S-1** | A | 3 | | | | | 3 |
| 14S-2 | Inst. | 4 | | | | | 4 |
| 14-3 | A | 1 | | | 1 | | |
| 14S-5 | Inst. | 5 | | | | | 5 |
| 14S-6 | Inst. | 6 | | | | | 6 |
| 14S-7 | A | 3 | | | | | 3 |
| 14S-9** | A | 2 | | | | | 2 |
| 14S-10 | Inst. | 4 | | | | | 4 |
| 14S-11 | Inst. | 4 | | | | | 4 |
| 14S-12 | A | 3 | | | | | 3 |
| 14S-13 | A | 3 | | | | | 3 |
| 16S-1 | A | 7 | | | | | 7 |
| 16-2* | E | 1 | | | | 1 | |
| 16S-3* | B | 1 | | | | | 1 |
| 16S-4* | D | 2 | | | | | 2 |
| 16-7* | A | 3 | | | 1 | | 2 |
| 16S-8 | A | 5 | | | | | 5 |
| 16-9 | A | 4 | | | | 2 | 2 |
| 16-10 | A | 3 | | | | 3 | |
| 16-11 | A | 2 | | | | 2 | |
| 16-12 | A | 1 | | 1 | | | |
| 16-13 | A | 2 | | | | 2 | |
| 18-1 | A/Inst. | 10 | | | | | 10 |
| 18-4 | D | 4 | | | | | 4 |
| 18-5• | D | 3 | | | | 2 | 1 |
| 18-6* | D | 1 | | 1 | | | |
| 18-7* | B | 1 | | | 1 | | |
| 18-8 | A | 8 | | | | 1 | 7 |
| 18-9 | Inst. | 7 | | | | 2 | 5 |
| 18-10** | A | 4 | | | | 4 | |
| 18-11 | A | 5 | | | | 5 | |
| 18-12 | A | 6 | | | | | 6 |
| 18-13 | A | 4 | | | 1 | 3 | |
| 18-14* | A | 2 | | 1 | | | 1 |
| 18-15 | A | 4 | | | | 4 | |
| 18-16* | C | 1 | | | | 1 | |
| 18-17 | Inst. | 7 | | | | 2 | 5 |
| 18-18 | Inst. | 7 | | | | 2 | 5 |
| 18-19** | A | 10 | | | | | 10 |
| 18-22** | D | 3 | | | | | 3 |

| Insert Arrangement | Service Rating | Total Contacts | Contact Size | | | | |
|--------------------|----------------|----------------|--------------|---|---|----|----|
| | | | 0 | 4 | 8 | 12 | 16 |
| 18-23 | A/Inst. | 10 | | | | | 10 |
| 18-24 | A/Inst. | 10 | | | | | 10 |
| 18-27• | D | 3 | | | | 2 | 1 |
| 18-28• | D | 3 | | | | 2 | 1 |
| 20-2 | D | 1 | 1 | | | | |
| 20-4 | D | 4 | | | | 4 | |
| 20-7 | D/A | 8 | | | | | 8 |
| 20-8 | Inst. | 6 | | | 2 | | 4 |
| 20-9* | D/A | 8 | | | | 1 | 7 |
| 20-14 | A | 5 | | | 2 | 3 | |
| 20-15 | A | 7 | | | | 7 | |
| 20-16 | A | 9 | | | | 2 | 7 |
| 20-17 | A | 6 | | | | 5 | 1 |
| 20-18 | A | 9 | | | | 3 | 6 |
| 20-19 | A | 3 | | | 3 | | |
| 20-21 | A | 9 | | | | 1 | 8 |
| 20-22 | A | 6 | | | 3 | | 3 |
| 20-24 | A | 4 | | | 2 | | 2 |
| 20-27 | A | 14 | | | | | 14 |
| 20-29 | A | 17 | | | | | 17 |
| 20-32 | D/A | 8 | | | | | 8 |
| 20-33 | A | 11 | | | | | 11 |
| 22-2 | D | 3 | | | 3 | | |
| 22-4** | A | 4 | | | 2 | 2 | |
| 22-5 | D | 6 | | | | 2 | 4 |
| 22-6* | D | 3 | | | 2 | | 1 |
| 22-7* | E | 1 | 1 | | | | |
| 22-9* | E | 3 | | | | 3 | |
| 22-10* | E | 4 | | | | | 4 |
| 22-11* | B | 2 | | | | | 2 |
| 22-12* | D | 5 | | | 2 | | 3 |
| 22-14 | A | 19 | | | | | 19 |
| 22-15* | E/A | 6 | | | | 5 | 1 |
| 22-17* | D/A | 9 | | | | 1 | 8 |
| 22-18* | D/A | 8 | | | | | 8 |
| 22-19 | A | 14 | | | | | 14 |
| 22-21 | A | 3 | 1 | | | | 2 |
| 22-22 | A | 4 | | | 4 | | |
| 22-23 | D/A | 8 | | | | 8 | |
| 22-27* | D/A | 9 | | | 1 | | 8 |
| 22-30 | A | 19 | | | | | 19 |
| 22-32 | D | 6 | | | | 2 | 4 |
| 22-36* | D/A | 8 | | | | 8 | |
| 24-1** | D | 2 | 1 | | | 1 | |
| 24-2 | D | 7 | | | | 7 | |
| 24-4* | D | 4 | 1 | | | | 3 |
| 24-5** | A | 16 | | | | | 16 |
| 24-6* | D/A | 8 | | | | 8 | |

* Consult Amphenol Aerospace for availability
 ** Inactive for new design
 • Socket Only

MIL-DTL-5015 Crimp Rear Release Insert Availability and Identification



38999

| Insert Arrangement | Service Rating | Total Contacts | Contact Size | | | | |
|--------------------|----------------|----------------|--------------|---|---|----|----|
| | | | 0 | 4 | 8 | 12 | 16 |
| 24-7 | A | 16 | | | | 2 | 14 |
| 24-10 | A | 7 | | | 7 | | |
| 24-11 | A | 9 | | | 3 | 6 | |
| 24-12 | A | 5 | | 2 | | 3 | |
| 24-15 | A | 16 | | | | | 16 |
| 24-16* | D/A | 7 | | | 1 | 3 | 3 |
| 24-20 | D | 11 | | | | 2 | 9 |
| 24-21* | D | 10 | | | 1 | | 9 |
| 24-22 | D | 4 | | | 4 | | |
| 24-24 | A | 16 | | | | | 16 |
| 24-27* | E | 7 | | | | | 7 |
| 24-28 | Inst. | 24 | | | | | 24 |
| 24-80* | Inst. | 23 | | | | | 23 |
| 28-1 | D/A | 9 | | | 3 | 6 | |
| 28-2 | D | 14 | | | | 2 | 12 |
| 28-3* | E | 3 | | | 3 | | |
| 28-4* | E/D | 9 | | | | 2 | 7 |
| 28-5* | D | 5 | | 2 | | 1 | 2 |
| 28-8* | E/D/A | 12 | | | | 2 | 10 |
| 28-9 | D | 12 | | | | 6 | 6 |
| 28-10 | D/A | 7 | | 2 | 2 | 3 | |
| 28-11 | A | 22 | | | | 4 | 18 |
| 28-12 | A | 26 | | | | | 26 |
| 28-13 | A | 26 | | | | | 26 |
| 28-15 | A | 35 | | | | | 35 |
| 28-16* | A | 20 | | | | | 20 |
| 28-17 | B/D/A | 15 | | | | | 15 |
| 28-18* | C/D/A/Inst. | 12 | | | | | 12 |
| 28-19* | B/D/A | 10 | | | | 4 | 6 |
| 28-20 | A | 14 | | | | 10 | 4 |
| 28-21 | A | 37 | | | | | 37 |
| 28-22 | D | 6 | | 3 | | | 3 |
| 32-1 | E/D | 5 | 2 | | | 3 | |
| 32-2* | E | 5 | | 3 | | | 2 |
| 32-3* | D | 9 | 1 | 2 | | 2 | 4 |
| 32-6 | A | 23 | | 2 | 3 | 2 | 16 |
| 32-7 | Inst./A | 35 | | | | 7 | 28 |
| 32-9 | D | 14 | | 2 | | | 12 |
| 32-13 | D | 23 | | | | 5 | 18 |
| 32-15 | D | 8 | 2 | | | 6 | |
| 32-16 | A | 23 | | 2 | 3 | 2 | 16 |
| 32-17 | D | 4 | | 4 | | | |
| 32-19 | E/D | 5 | 2 | | | 3 | |
| 32-20 | A | 23 | | 2 | 3 | 2 | 16 |

| Insert Arrangement | Service Rating | Total Contacts | Contact Size | | | | |
|--------------------|----------------|----------------|--------------|---|---|----|----|
| | | | 0 | 4 | 8 | 12 | 16 |
| 32-22* | A | 54 | | | | | 54 |
| 32-63 | D | 5 | | 5 | | | |
| 32-73 | A | 46 | | | | | 46 |
| 36-3 | D | 6 | 3 | | | 3 | |
| 36-5 | A | 4 | 4 | | | | |
| 36-6 | A | 6 | 2 | 4 | | | |
| 36-7 | A | 47 | | | | 7 | 40 |
| 36-8 | A | 47 | | | | 1 | 46 |
| 36-9 | A | 31 | | 1 | 2 | 14 | 14 |
| 36-10 | A | 48 | | | | | 48 |
| 36-11 | A | 48 | | | | | 48 |
| 36-12 | A | 48 | | | | | 48 |
| 36-15 | D/A | 35 | | | | | 35 |
| 36-16 | A | 47 | | | | 7 | 40 |
| 36-17 | A | 47 | | | | 7 | 40 |
| 36-18 | A | 31 | | 1 | 2 | 14 | 14 |
| 36-21 | A | 31 | | 1 | 2 | 14 | 14 |
| 36-52 | A | 52 | | | | | 52 |
| 36-66* | A | 56 | | | | 4 | 52 |
| 40-1 | D | 30 | | | | 6 | 24 |
| 40-2* | D | 23 | | | | | 23 |
| 40-3* | D | 23 | | 1 | | 4 | 18 |
| 40-4* | D | 23 | | 2 | 3 | 2 | 16 |
| 40-5* | A | 15 | 3 | 2 | 4 | 6 | |
| 40-6* | D | 26 | 1 | | | 1 | 24 |
| 40-7* | A/D | 22 | 2 | | | 2 | 18 |
| 40-9 | A | 47 | | | 1 | 22 | 24 |
| 40-10* | A | 29 | | 4 | 9 | | 16 |
| 40-11* | D | 25 | 1 | 1 | 1 | 4 | 18 |
| 40-56 | A | 85 | | | | | 85 |
| 40-62* | A | 60 | | | | | 60 |

* Consult Amphenol Aerospace for availability
** Inactive for new design

III
HD
Dualok
II
I
SJT
Accessories
Aquacon
Herm/Seal
PCB

HIGH SPEED
Fiber Optics
Contacts
Connectors
Cables

EMI Filter
Transient
26482
Matrix 2
83723 III
Matrix | Pyle

26500
Pyle

5015
Crimp Rear
Release
Matrix

22992
Class 1

Back-
Shells

Options
Others

38999

- III
- HD
- Dualok
- II
- I
- SJT
- Accessories
- Aquacon
- Herm/Seal
- PCB

Front Face of Pin Insert or Rear Face of Socket Insert Illustrated



| Insert Arrangement | 8S-1 | 10S-2 | 10SL-3 | 10SL-4 | 12S-1 | 12S-2 | 12S-3 |
|--------------------|------|-------|--------|--------|-------|-------|-------|
| Service Rating | A | A | A*** | A | A | A | A |
| Number of Contacts | 1 | 1 | 3 | 2 | 2 | 2 | 2 |
| Contact Size | 16 | 16 | 16 | 16 | 16 | 16 | 16 |

- HIGH SPEED
- Fiber Optics
- Contacts Connectors Cables

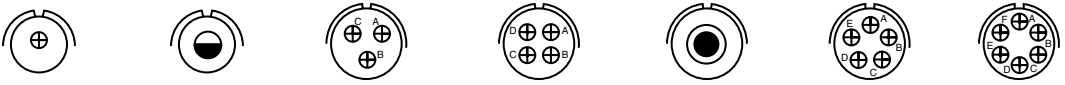

| Insert Arrangement | 12S-4 | 12-5 | 14S-1** | 14S-2 | 14-3 | 14S-5 | 14S-6 |
|--------------------|-------|------|---------|-------|------|-------|-------|
| Service Rating | D | D | A | Inst. | A | Inst. | Inst. |
| Number of Contacts | 1 | 1 | 3 | 4 | 1 | 5 | 6 |
| Contact Size | 16 | 12 | 16 | 16 | 8 | 16 | 16 |

- EMI Filter Transient

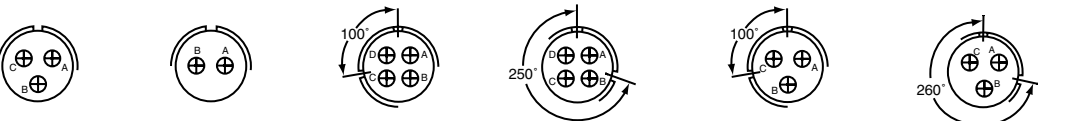

| Insert Arrangement | 14S-7 | 14S-9** | 14S-10 | 14S-11 | 14S-12 | 14S-13 |
|--------------------|-------|---------|--------|--------|--------|--------|
| Service Rating | A | A | Inst. | Inst. | A | A |
| Number of Contacts | 3 | 2 | 4 | 4 | 3 | 3 |
| Contact Size | 16 | 16 | 16 | 16 | 16 | 16 |

- 26482 Matrix 2

- 83723 III Matrix | Pyle

- 26500 Pyle



| Insert Arrangement | 16S-1 | 16-2* | 16S-3* | 16S-4* | 16-7* | 16S-8 |
|--------------------|-------|-------|--------|--------|-------|-------|
| Service Rating | A | E | B | D | A | A |
| Number of Contacts | 7 | 1 | 1 | 2 | 1 2 | 5 |
| Contact Size | 16 | 12 | 16 | 16 | 8 16 | 16 |

- 5015 Crimp Rear Release Matrix

- 22992 Class 1

- Back-Shells

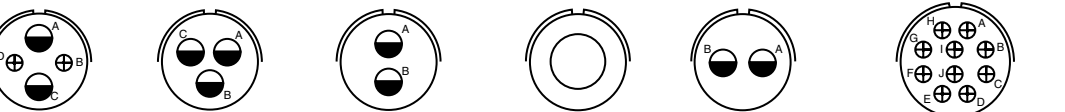

| Insert Arrangement | 16-9 | 16-10 | 16-11 | 16-12 | 16-13 | 18-1 |
|--------------------|-------|-------|-------|-------|-------|------------------------------|
| Service Rating | A | A | A | A | A | B, C, F, G = A; Bal. = Inst. |
| Number of Contacts | 2 2 | 3 | 2 | 1 | 2† | 10 |
| Contact Size | 12 16 | 12 | 12 | 4 | 12 | 16 |

- Options Others

* Consult Amphenol Aerospace for availability.
 ** Inactive for new design
 *** Service rating Inst. Class K
 † one Iron contact and one Constantan contact

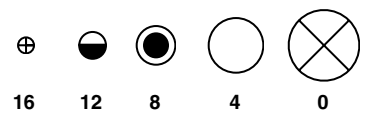

MIL-DTL-5015 Crimp Rear Release Insert Arrangements

Front Face of Pin Insert or Rear Face of Socket Insert Illustrated



| | | | | | | | | | |
|---------------------------|-------------|---------------|----|--------------|--------------|--------------|----|-------------|----|
| Insert Arrangement | 18-4 | 18-5 • | | 18-6* | 18-7* | 18-8* | | 18-9 | |
| Service Rating | D | D | | D | B | A | | Inst. | |
| Number of Contacts | 4 | 2 | 1 | 1 | 1 | 1 | 7 | 2 | 5 |
| Contact Size | 16 | 12 | 16 | 4 | 8 | 12 | 16 | 12 | 16 |

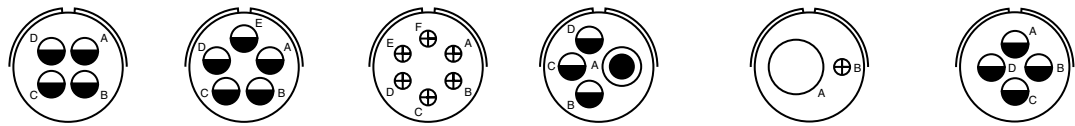

| | | | | | | | | | |
|---------------------------|----------------|--------------|--|--------------|--------------|----|---------------|----|--------------|
| Insert Arrangement | 18-10** | 18-11 | | 18-12 | 18-13 | | 18-14* | | 18-15 |
| Service Rating | A | A | | A | A | | A | | A |
| Number of Contacts | 4 | 5 | | 6 | 1 | 3 | 1 | 1 | 4†† |
| Contact Size | 12 | 12 | | 16 | 8 | 12 | 4 | 16 | 12 |

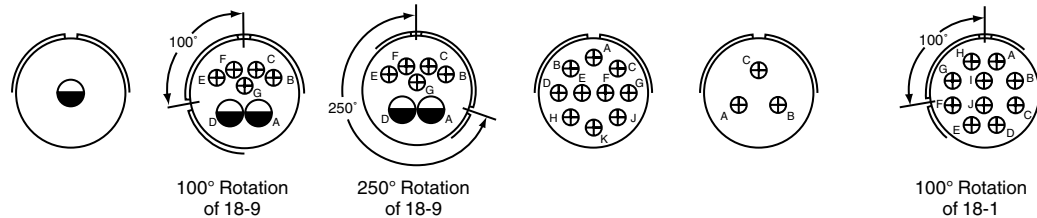

| | | | | | | | | | |
|---------------------------|---------------|--------------|----|--------------|----|----------------|----------------|------------------------------|--|
| Insert Arrangement | 18-16* | 18-17 | | 18-18 | | 18-19** | 18-22** | 18-23 | |
| Service Rating | C | Inst. | | Inst. | | A | D | B, C, F, G = A; Bal. = Inst. | |
| Number of Contacts | 1 | 2 | 5 | 2 | 5 | 10 | 3 | 10 | |
| Contact Size | 12 | 12 | 16 | 12 | 16 | 16 | 16 | 16 | |

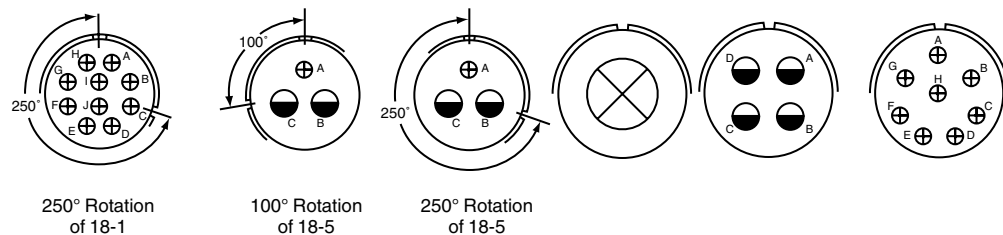

| | | | | | | | | | |
|---------------------------|------------------------------|----------------|----|----------------|----|-------------|-------------|--------------------------------|--|
| Insert Arrangement | 18-24 | 18-27 • | | 18-28 • | | 20-2 | 20-4 | 20-7 | |
| Service Rating | B, C, F, G = A; Bal. = Inst. | D | | D | | D | D | A, B, G, H = D; C, D, E, F = A | |
| Number of Contacts | 10 | 2 | 1 | 2 | 1 | 1 | 4 | 8 | |
| Contact Size | 16 | 12 | 16 | 12 | 16 | 0 | 12 | 16 | |

* Consult Amphenol Aerospace for availability.
 ** Inactive for new design\
 • Socket only
 † one Iron contact and one Constantan contact
 †† A, C = Iron; B, D = Constantan

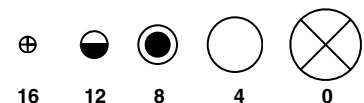

CONTACT LEGEND

38999

- III
- HD
- Dualok
- II
- I
- SJT
- Accessories
- Aquacon
- Herm/Seal
- PCB

- HIGH SPEED
- Fiber Optics
- Contacts Connectors Cables

- EMI Filter
- Transient
- 26482 Matrix 2
- 83723 III Matrix | Pyle
- 26500 Pyle

- 5015 Crimp Rear Release Matrix
- 22992 Class 1

- Back-Shell's
- Options Others

Front Face of Pin Insert or Rear Face of Socket Insert Illustrated

38999
III
HD
Dualok
II
I
SJT
Accessories
Aquacon
Herm/Seal
PCB

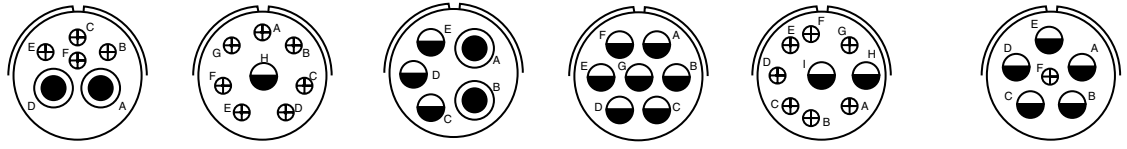

| Insert Arrangement | 20-8* | | 20-9* | | 20-14 | | 20-15 | | 20-16 | | 20-17 | |
|--------------------|-------|----|-----------------|----|-------|----|-------|--|-------|----|-------|----|
| Service Rating | Inst. | | H = D; Bal. = A | | A | | A | | A | | A | |
| Number of Contacts | 2 | 4 | 1 | 7 | 2 | 3 | 7 | | 2 | 7 | 5 | 1 |
| Contact Size | 8 | 16 | 12 | 16 | 8 | 12 | 12 | | 12 | 16 | 12 | 16 |

HIGH SPEED
Fiber Optics
Contacts
Connectors
Cables

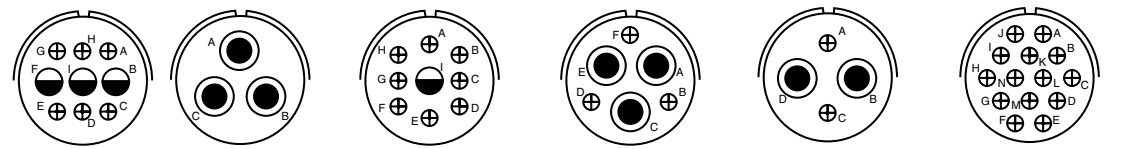

| Insert Arrangement | 20-18 | | 20-19 | | 20-21 | | 20-22 | | 20-24 | | 20-27 | |
|--------------------|-------|----|-------|--|-------|----|-------|----|-------|----|-------|--|
| Service Rating | A | | A | | A | | A | | A | | A | |
| Number of Contacts | 3 | 6 | 3 | | 1 | 8 | 3 | 3 | 2 | 2 | 14 | |
| Contact Size | 12 | 16 | 8 | | 12 | 16 | 8 | 16 | 8 | 16 | 16 | |

EMI Filter
Transient

26482
Matrix 2

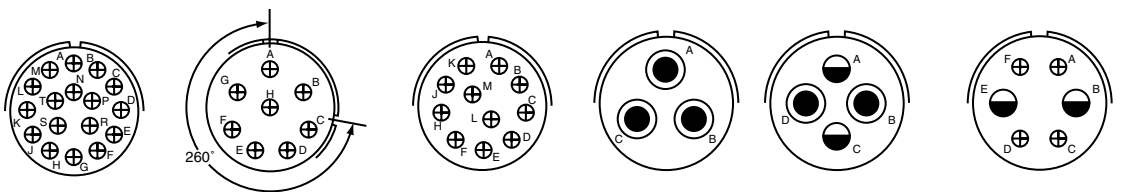

260° Rotation of 20-7

| Insert Arrangement | 20-29 | | 20-32 | | 20-33 | | 22-2 | | 22-4** | | 22-5 | |
|--------------------|-------|--|--------------------------|--|-------|--|------|--|--------|----|------|----|
| Service Rating | A | | A, B, G, H = D; Bal. = A | | A | | D | | A | | D | |
| Number of Contacts | 17 | | 8 | | 11 | | 3 | | 2 | 2 | 2 | 4 |
| Contact Size | 16 | | 16 | | 16 | | 8 | | 8 | 12 | 12 | 16 |

83723 III
Matrix | Pyle

26500
Pyle

5015
Crimp Rear Release
Matrix

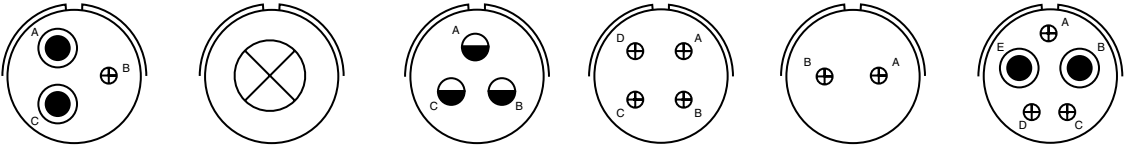

| Insert Arrangement | 22-6** | | 22-7* | | 22-9* | | 22-10* | | 22-11* | | 22-12* | |
|--------------------|--------|----|-------|--|-------|--|--------|--|--------|--|--------|----|
| Service Rating | D | | E | | E | | E | | B | | D | |
| Number of Contacts | 2 | 1 | 1 | | 3 | | 4 | | 2 | | 2 | 3 |
| Contact Size | 8 | 16 | 0 | | 12 | | 16 | | 16 | | 8 | 16 |

22992
Class I

Back-
Shells

Options
Others

* Consult Amphenol Aerospace for availability.

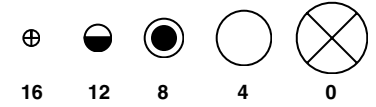

MIL-DTL-5015 Crimp Rear Release Insert Arrangements

Front Face of Pin Insert or Rear Face of Socket Insert Illustrated

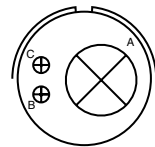
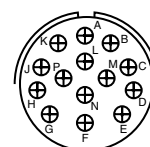
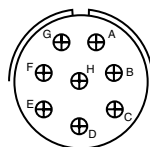
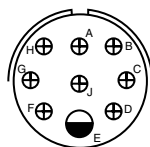
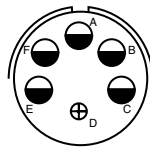
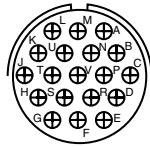

| Insert Arrangement | 22-14 | 22-15* | | 22-17* | | 22-18* | 22-19 | | 22-21 | |
|--------------------|-------|-----------------|----|-----------------|----|-----------------------|-------|--|-------|----|
| Service Rating | A | D = 3; Bal. = A | | A = D; Bal. = A | | C, D, E = A; Bal. = D | A | | A | |
| Number of Contacts | 19 | 5 | 1 | 1 | 8 | 8 | 14 | | 1 | 2 |
| Contact Size | 16 | 12 | 16 | 12 | 16 | 16 | 16 | | 0 | 16 |

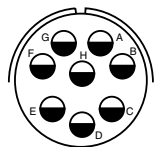
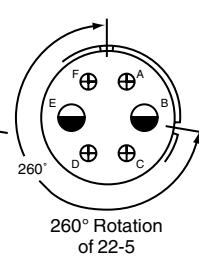
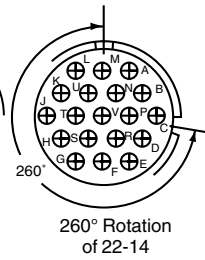
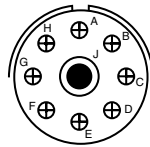
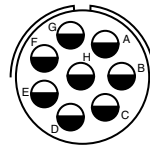
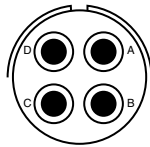

| Insert Arrangement | 22-22 | 22-23 | | 22-27* | | 22-30 | 22-32 | | 22-36* | |
|--------------------|-------|-----------------|--|-----------------|--|-------|-------|----|-----------------|----|
| Service Rating | A | H = D; Bal. = A | | J = D; Bal. = A | | A | D | | H = D; Bal. = A | |
| Number of Contacts | 4 | 8 | | 1 | | 8 | 19 | 2 | 4 | 8 |
| Contact Size | 8 | 12 | | 8 | | 16 | 16 | 12 | 16 | 12 |

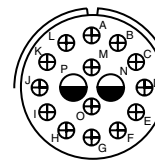
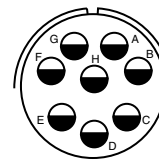
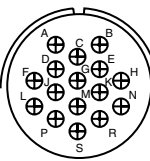
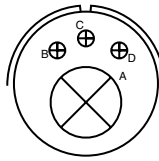
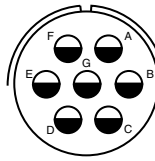
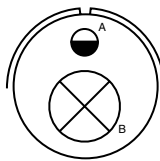

| Insert Arrangement | 24-1** | | 24-2 | | 24-4* | | 24-5** | 24-6* | | 24-7 | |
|--------------------|--------|----|------|----|-------|----|--------|-----------------------|----|------|----|
| Service Rating | D | | D | | D | | A | A, G, H = D; Bal. = A | | A | |
| Number of Contacts | 1 | 1 | 7 | 7 | 1 | 3 | 16 | 8 | 8 | 2 | 14 |
| Contact Size | 0 | 12 | 12 | 12 | 0 | 16 | 16 | 12 | 12 | 12 | 16 |

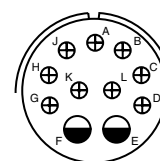
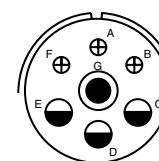
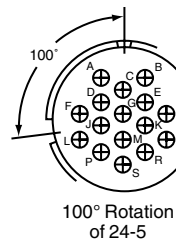
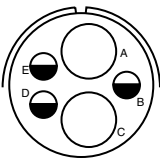
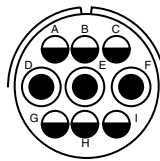
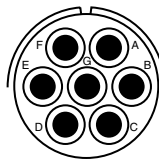

| Insert Arrangement | 24-10 | | 24-11 | | 24-12 | | 24-15 | | 24-16* | | | 24-20 |
|--------------------|-------|---|-------|----|-------|----|-------|---|-----------------------------|----|----|-------|
| Service Rating | A | | A | | A | | A | | A, B, F, G = D; C, D, E = A | | | D |
| Number of Contacts | 7 | 7 | 3 | 6 | 2 | 3 | 16 | 1 | 3 | 3 | 2 | 9 |
| Contact Size | 8 | 8 | 8 | 12 | 4 | 12 | 16 | 8 | 12 | 16 | 12 | 16 |

* Consult Amphenol Aerospace for availability.
 ** Inactive for new design

CONTACT LEGEND

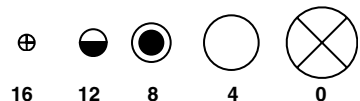

38999

- III
- HD
- Dualok
- II
- I
- SJT
- Accessories
- Aquacon
- Herm/Seal
- PCB

- HIGH SPEED
- Fiber Optics
- Contacts Connectors Cables

EMI Filter
Transient

26482
Matrix 2

83723 III
Matrix | Pyle

26500
Pyle

5015
Crimp Rear Release Matrix

22992
Class 1

Back-Shell's

Options
Others

38999
III
HD
Dualok
II
I
SJT
Accessories
Aquacon
Herm/Seal
PCB

Front Face of Pin Insert or Rear Face of Socket Insert Illustrated

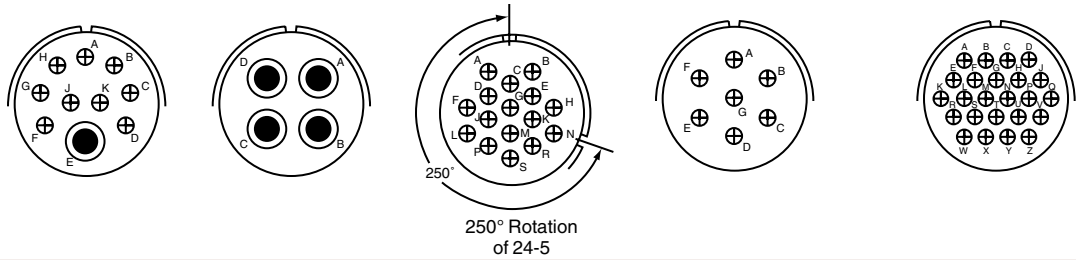

| Insert Arrangement | 24-21* | | 24-22 | | 24-24 | | 24-27* | | 24-28 | |
|--------------------|--------|----|-------|---|-------|----|--------|----|-------|--|
| Service Rating | D | | D | | A | | E | | Inst. | |
| Number of Contacts | 1 | 9 | 4 | 8 | 16 | 16 | 7 | 16 | 24 | |
| Contact Size | 8 | 16 | 8 | 8 | 16 | 16 | 16 | 16 | 16 | |

HIGH SPEED
Fiber Optics
Contacts
Connectors
Cables

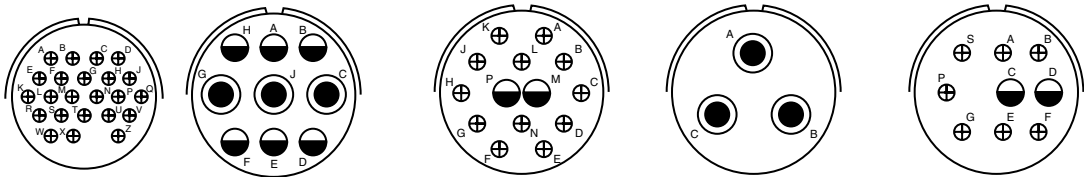

| Insert Arrangement | 24-80* | | | 28-1 | | 28-2 | | 28-3* | | 28-4* | |
|--------------------|--------|---|----|-----------------------|----|------|----|-------|---|-----------------------|----|
| Service Rating | Inst. | | | A, J, E = D; Bal. = A | | D | | E | | G, P, S = E; Bal. = D | |
| Number of Contacts | 23 | 3 | 6 | 3 | 6 | 2 | 12 | 3 | 8 | 2 | 7 |
| Contact Size | 16 | 8 | 12 | 8 | 12 | 12 | 16 | 8 | 8 | 12 | 16 |

EMI Filter
Transient

26482
Matrix 2

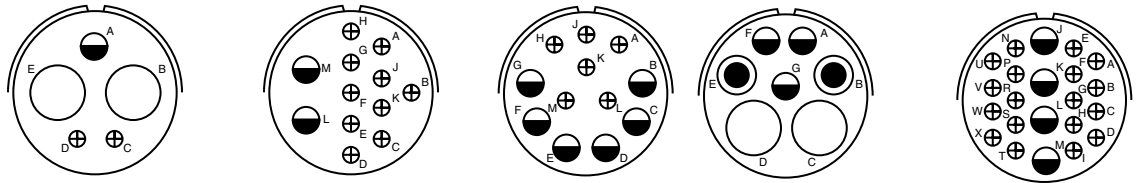

| Insert Arrangement | 28-5* | | | 28-8* | | 28-9 | | 28-10 | | | 28-11 | |
|--------------------|-------|----|----|---------------------------|----|------|----|-----------------|---|----|-------|----|
| Service Rating | D | | | L, M = E; B = D; Bal. = A | | D | | G = D, Bal. = A | | | A | |
| Number of Contacts | 2 | 1 | 2 | 2 | 10 | 6 | 6 | 2 | 2 | 3 | 4 | 18 |
| Contact Size | 4 | 12 | 16 | 12 | 16 | 12 | 16 | 4 | 8 | 12 | 12 | 16 |

83723 III
Matrix | Pyle

26500
Pyle

5015
Crimp Rear Release Matrix

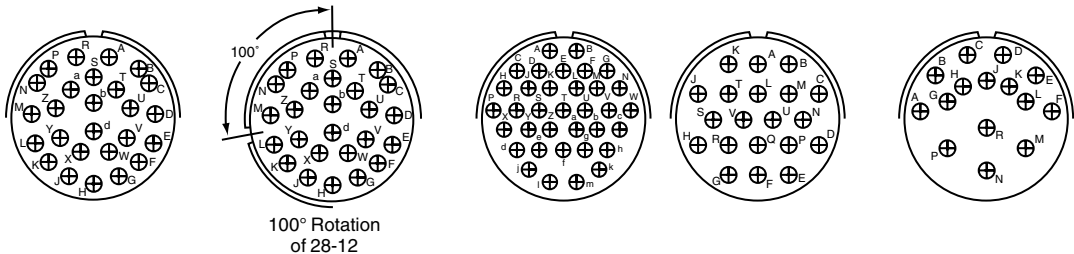

| Insert Arrangement | 28-12 | | 28-13 | | 28-15 | | 28-16** | | 28-17 | |
|--------------------|-------|--|-------|--|-------|--|---------|--|------------------------------|--|
| Service Rating | A | | A | | A | | A | | R = B; M, N, P = D; Bal. = A | |
| Number of Contacts | 26 | | 26 | | 35 | | 20 | | 15 | |
| Contact Size | 16 | | 16 | | 16 | | 16 | | 16 | |

22992
Class I

Back-Shells

Options
Others

* Consult Amphenol Aerospace for availability.

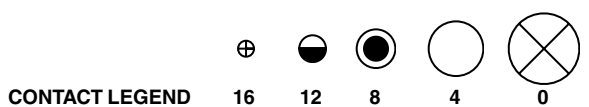

MIL-DTL-5015 Crimp Rear Release Insert Arrangements

Front Face of Pin Insert or Rear Face of Socket Insert Illustrated

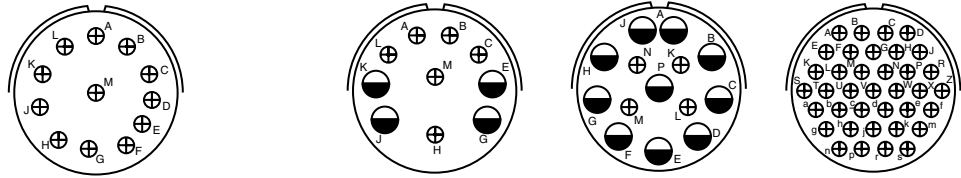

| Insert Arrangement | 28-18* | 28-19* | 28-20 | 28-21 |
|--------------------|--|------------------------------|----------|-------|
| Service Rating | M = C; G, H, J, K, L = D; A, B = A; Bal. = Inst. | H, M = B; A, B = D; Bal. = A | A | A |
| Number of Contacts | 12 | 4 6 | 10 4 | 37 |
| Contact Size | 16 | 12 16 | 12 16 | 16 |

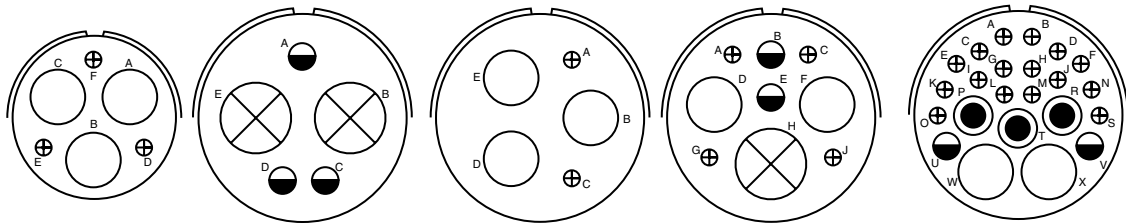

| Insert Arrangement | 28-22 | 32-1 | 32-2* | 32-3* | 32-6 |
|--------------------|---------|-----------------------|---------|--------------------|--------------------|
| Service Rating | D | A = E; B, C, D, E = D | E | D | A |
| Number of Contacts | 3 3 | 2 3 | 3 2 | 1 2 2 4 | 2 3 2 16 |
| Contact Size | 4 16 | 0 12 | 4 16 | 0 4 12 16 | 4 8 12 16 |

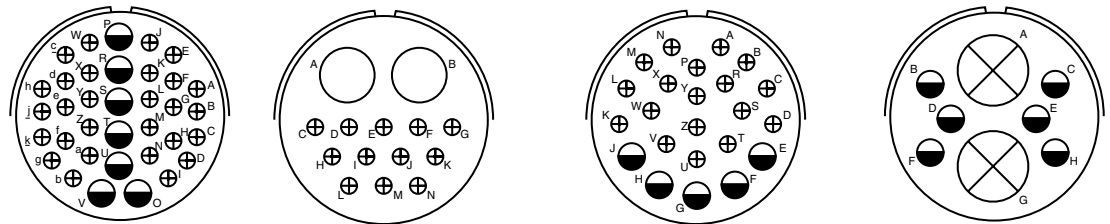

| Insert Arrangement | 32-7 | 32-9 | 32-13 | 32-15 |
|--------------------|------------------------------|-----------|-----------|-----------|
| Service Rating | A, B, h, j = Inst.; Bal. = A | D | D | D |
| Number of Contacts | 7 28 | 2 12 | 5 18 | 2 6 |
| Contact Size | 12 16 | 4 16 | 12 16 | 0 12 |

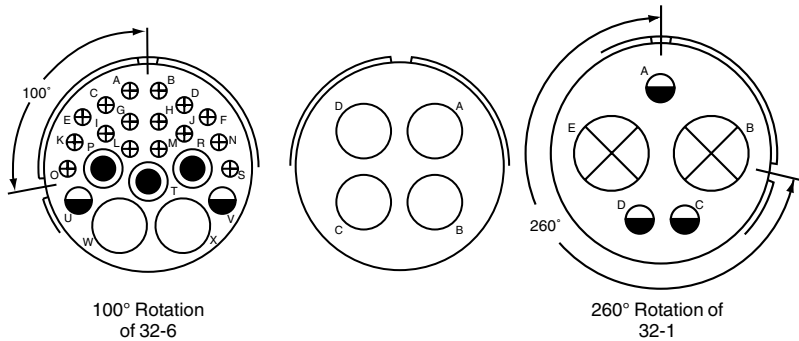

| Insert Arrangement | 32-16 | 32-17 | 32-19 |
|--------------------|--------------------|-------|-----------------|
| Service Rating | A | D | A = E, Bal. = D |
| Number of Contacts | 2 3 2 16 | 4 | 2 3 |
| Contact Size | 4 8 12 16 | 4 | 0 12 |

* Consult Amphenol Aerospace for availability.
 ** Inactive for new design

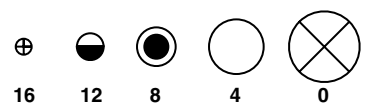

38999

- III
- HD
- Dualok
- II
- I
- SJT
- Accessories
- Aquacon
- Herm/Seal
- PCB

- HIGH SPEED
- Fiber Optics
- Contacts Connectors Cables

EMI Filter
Transient

26482
Matrix 2

83723 III
Matrix | Pyle

26500
Pyle

5015
Crimp Rear Release Matrix

22992
Class 1

Back-Shells

Options
Others

Front Face of Pin Insert or Rear Face of Socket Insert Illustrated

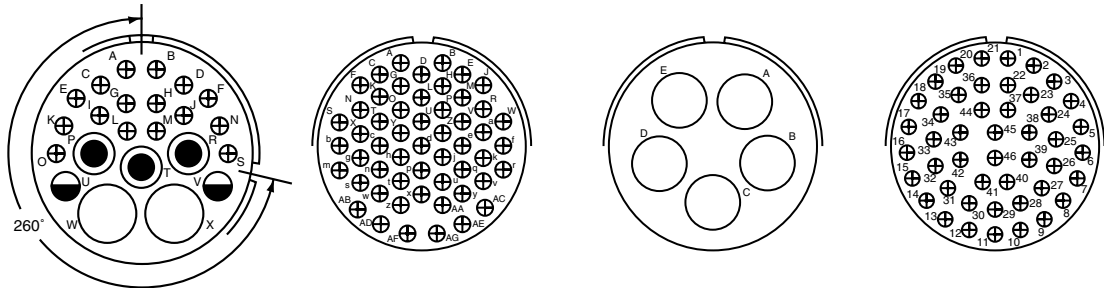

260° Rotation of 32-6

| Insert Arrangement | 32-20 | | | | 32-22* | | | | 32-63 | | | | 32-73 | | | |
|--------------------|-------|---|----|----|--------|--|--|--|-------|--|--|--|-------|--|--|--|
| Service Rating | A | | | | A | | | | D | | | | A | | | |
| Number of Contacts | 2 | 3 | 2 | 16 | 54 | | | | 5 | | | | 46 | | | |
| Contact Size | 4 | 8 | 12 | 16 | 16 | | | | 4 | | | | 16 | | | |

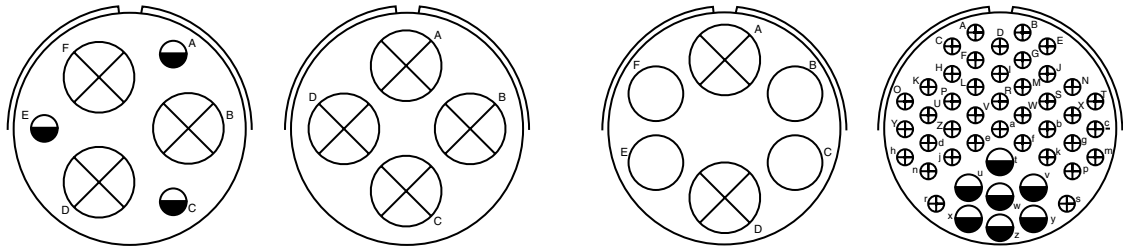

| Insert Arrangement | 36-3 | | 36-5 | | 36-6 | | 36-7 | |
|--------------------|------|----|------|--|------|---|------|----|
| Service Rating | D | | A | | A | | A | |
| Number of Contacts | 3 | 3 | 4 | | 2 | 4 | 7 | 40 |
| Contact Size | 0 | 12 | 0 | | 0 | 4 | 12 | 16 |

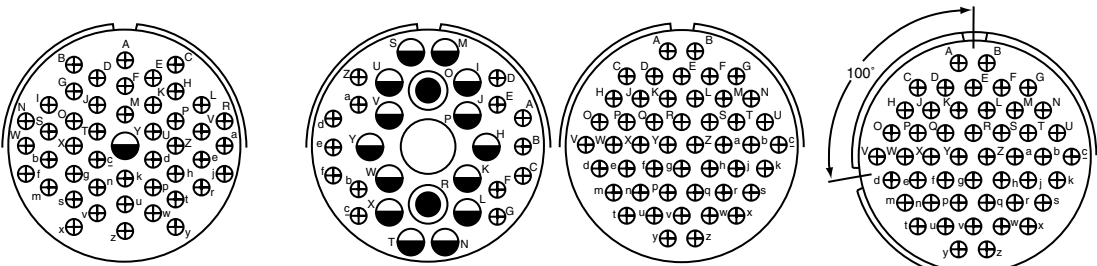

100° Rotation of 36-10

| Insert Arrangement | 36-8 | | 36-9 | | | | 36-10 | | 36-11 | |
|--------------------|------|----|------|---|----|----|-------|--|-------|--|
| Service Rating | A | | A | | | | A | | A | |
| Number of Contacts | 1 | 46 | 1 | 2 | 14 | 14 | 48 | | 48 | |
| Contact Size | 12 | 16 | 4 | 8 | 12 | 16 | 16 | | 16 | |

* Consult Amphenol Aerospace for availability.

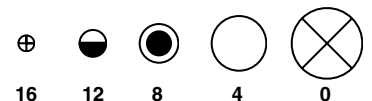

CONTACT LEGEND 16 12 8 4 0

38999
III
HD
Dualok
II
I
SJT
Accessories
Aquacon
Herm/Seal
PCB

HIGH SPEED
Fiber Optics
Contacts
Connectors
Cables

EMI Filter
Transient

26482
Matrix 2

83723 III
Matrix | Pyle

26500
Pyle

5015
Crimp Rear Release
Matrix

22992
Class I

Back-
Shells

Options
Others

MIL-DTL-5015 Crimp Rear Release Insert Arrangements

Front Face of Pin Insert or Rear Face of Socket Insert Illustrated

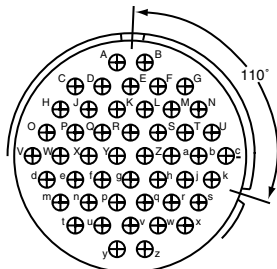

110° Rotation of 36-10

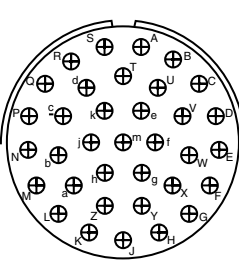

100° Rotation of 36-7

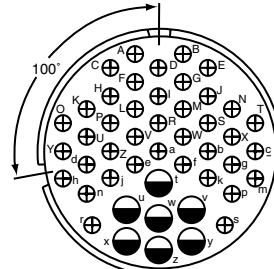

100° Rotation of 36-6

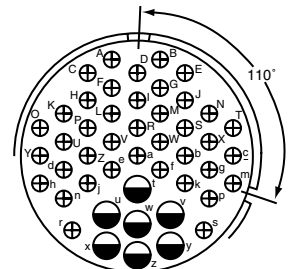

110° Rotation of 36-17

| Insert Arrangement | 36-12 | 36-15 | 36-16 | | 36-17 | |
|--------------------|-------|-----------------|-------|----|-------|----|
| Service Rating | A | M = D, Bal. = A | A | | A | |
| Number of Contacts | 48 | 35 | 7 | 40 | 7 | 40 |
| Contact Size | 16 | 16 | 12 | 16 | 12 | 16 |

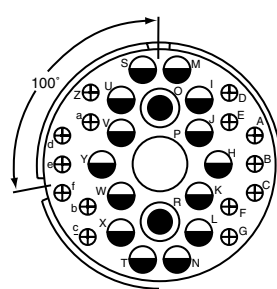

100° Rotation of 36-9

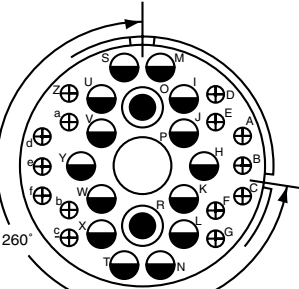

260° Rotation of 36-9

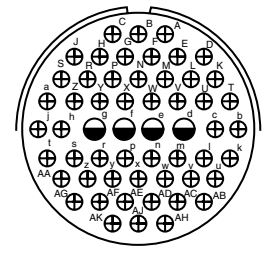
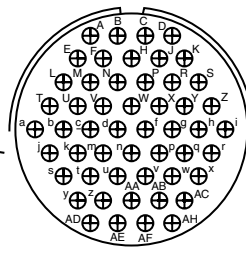

| Insert Arrangement | 36-18 | | | | 36-21 | | | | 36-52 | 36-66* | |
|--------------------|-------|---|----|----|-------|---|----|----|-------|--------|----|
| Service Rating | A | | | | A | | | | A | A | |
| Number of Contacts | 1 | 2 | 14 | 14 | 1 | 2 | 14 | 14 | 52 | 4 | 52 |
| Contact Size | 4 | 8 | 12 | 16 | 4 | 8 | 12 | 16 | 16 | 12 | 16 |

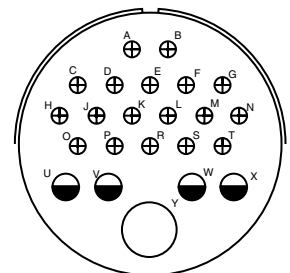
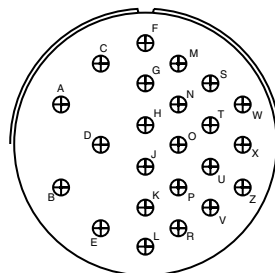
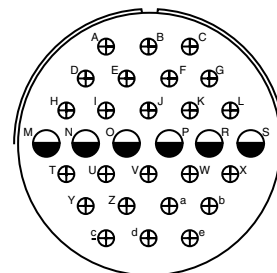

| Insert Arrangement | 40-1 | | 40-2* | 40-3* | | |
|--------------------|------|----|-------|-------|----|----|
| Service Rating | D | | D | D | | |
| Number of Contacts | 6 | 24 | 23 | 1 | 4 | 18 |
| Contact Size | 12 | 16 | 16 | 4 | 12 | 16 |

* Consult Amphenol Aerospace for availability.

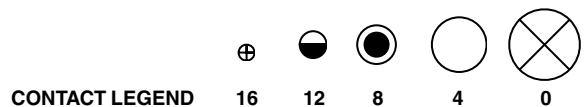

38999

- III
- HD
- Duallok
- II
- I
- SJT
- Accessories
- Aquacon
- Herm/Seal
- PCB

- HIGH SPEED
- Fiber Optics
- Contacts Connectors Cables

EMI Filter Transient

26482 Matrix 2

83723 III Matrix | Pyle

26500 Pyle

5015 Crimp Rear Release Matrix

22992 Class I

Back-Shell's

Options Others

Front Face of Pin Insert or Rear Face of Socket Insert Illustrated

- 38999
- III
- HD
- Dualok
- II
- I
- SJT
- Accessories
- Aquacon
- Herm/Seal
- PCB

- HIGH SPEED
- Fiber Optics
- Contacts Connectors Cables

- EMI Filter Transient

- 26482 Matrix 2

- 83723 III Matrix | Pyle

- 26500 Pyle

- 5015 Crimp Rear Release Matrix

- 22992 Class I

- Back-Shells

- Options Others

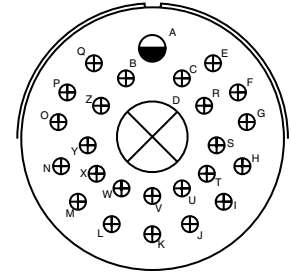
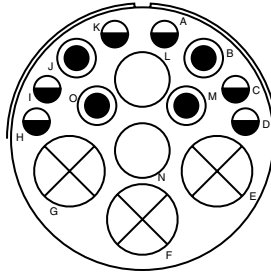
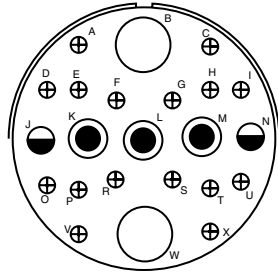

| Insert Arrangement | 40-4* | | | | 40-5* | | | | 40-6* | | |
|--------------------|-------|---|----|----|-------|---|---|----|-------|----|----|
| Service Rating | D | | | | A | | | | D | | |
| Number of Contacts | 2 | 3 | 2 | 16 | 3 | 2 | 4 | 6 | 1 | 1 | 24 |
| Contact Size | 4 | 8 | 12 | 16 | 0 | 4 | 8 | 12 | 0 | 12 | 16 |

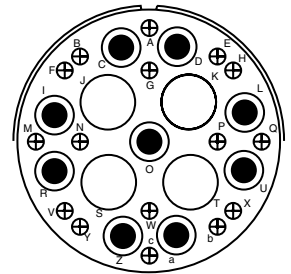
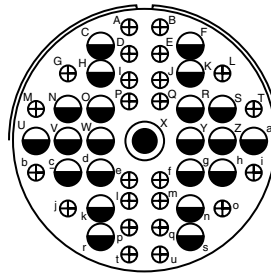
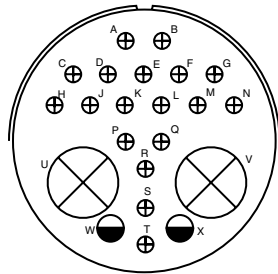

| Insert Arrangement | 40-7* | | | 40-9 | | | 40-10* | | |
|--------------------|--------------------------------|----|----|------|----|----|--------|---|----|
| Service Rating | P, Q, U, V, W, X = A; Bal. = D | | | A | | | A | | |
| Number of Contacts | 2 | 2 | 18 | 1 | 22 | 24 | 4 | 9 | 16 |
| Contact Size | 0 | 12 | 16 | 8 | 12 | 16 | 4 | 8 | 16 |

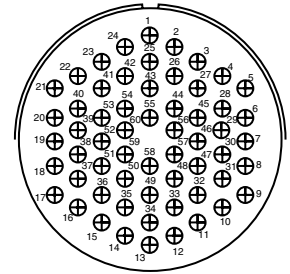
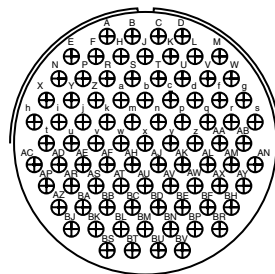
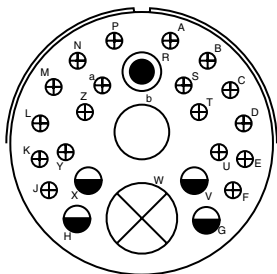

| Insert Arrangement | 40-11* | | | | | 40-56 | 40-62* |
|--------------------|--------|---|---|----|----|-------|--------|
| Service Rating | D | | | | | A | A |
| Number of Contacts | 1 | 1 | 1 | 4 | 18 | 85 | 60 |
| Contact Size | 0 | 4 | 8 | 12 | 16 | 16 | 16 |

* Consult Amphenol Aerospace for availability.

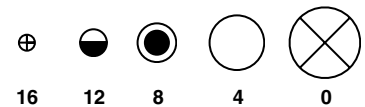

MIL-DTL-5015 Crimp Rear Release

Class Descriptions, Performance Specifications

CLASS DESCRIPTIONS

| Military MIL-DTL-5015 | |
|-----------------------|--|
| Class L* | Aluminum shell, electroless nickel finish, fluid resistant insert |
| Class W | Aluminum shell, cadmium olive drab finish, fluid resistant insert |
| Class LS | Stainless steel shell, passivated, fluid resistant insert |
| Class KT** | Firewall, steel shell, cadmium olive drab finish, non-flammable hard dielectric and fluid resistant insert |
| Class KS | Firewall, stainless steel shell, passivated, non-flammable hard dielectric and fluid resistant insert |

| Amphenol/Matrix | |
|-----------------|--|
| Class A | Aluminum shell, black anodize finish, fluid resistant insert |
| Class F | Aluminum shell, electroless nickel finish, fluid resistant insert |
| Class W | Aluminum shell, cadmium/olive drab finish, fluid resistant insert |
| Class FS | Stainless steel shell, passivated, fluid resistant insert |
| Class KT | Firewall, steel shell, cadmium olive drab finish, non-flammable hard dielectric and fluid resistant insert |
| Class KS | Firewall, stainless steel shell, passivated, non-flammable hard dielectric and fluid resistant insert |

* Class L inactivates older Class U (aluminum, electroless nickel)

** Class KT (ferrous alloy, cadmium/olive drab) inactivates older Class K (ferrous alloy, electroless nickel)

PERFORMANCE SPECIFICATIONS

VOLTAGE RATING

| Altitude | Inst. | A | D | E | B | C |
|-------------|-------|------|------|------|------|------|
| Sea Level | 1000 | 2000 | 2800 | 3500 | 4500 | 7000 |
| 50,000 ft. | 400 | 600 | 675 | 750 | 825 | 975 |
| 70,000 ft. | 260 | 360 | 400 | 440 | 480 | 560 |
| 110,000 ft. | 200 | 200 | 200 | 200 | 200 | 200 |

SHOCK

Wired, mated connectors are subjected to one shock in each of three mutually perpendicular axes with pulse of an approximate half sine wave of 50g magnitude for a duration of 11 milliseconds. All contacts wired in series circuit with 100 ±10 Milliampères of current flow.

OPERATING TEMPERATURE RANGE

Classes L, LS and KS have temperature range of -55°C (-75°F) to 200°C (392°F)

Classes W and KT have temperature range of -55°C (-75°F) to 175°C (347°F)

ENVIRONMENTAL SEAL

Wired, mated connectors with the specified accessory attached will meet the altitude immersion test specified in MIL-DTL-5015.

DURABILITY

Minimum of 100 mating cycles.

38999

- III
- HD
- Dualok
- II
- I
- SJT
- Accessories
- Aquacon
- Herm/Seal
- PCB

- HIGH SPEED
- Fiber Optics
- Contacts Connectors Cables

- EMI Filter
- Transient

- 26482
- Matrix 2

- 83723 III
- Matrix | Pyle

- 26500
- Pyle

- 5015
- Crimp Rear Release Matrix

- 22992
- Class L

- Back-Shells

- Options Others

38999

To avoid cross-plugging problems in applications requiring the use of more than one connector of the same size and arrangement, alternate rotations are available as indicated in the accompanying charts.

As shown in the diagram below, the front face of the pin insert is rotated within the shell in a clockwise direction from the normal shell key. The socket insert would be rotated counter-clockwise the same number of degrees in respect to the normal shell key.

The charts give the W, X, Y, Z positions for the alternate rotations available for the insert arrangements of the rear release MIL-DTL-5015 series of connectors. If an insert arrangement number is not given, then there is no available alternate rotation for that pattern.

The following insert arrangements have the same alternate insert rotations for W, X, Y and Z, which are:

| Degrees | | | |
|---------|-----|-----|-----|
| W | X | Y | Z |
| 80 | 110 | 250 | 280 |

| | | | | | |
|-------|-------|-------|-------|-------|-------|
| 16-7 | 20-22 | 24-4 | 28-4 | 28-21 | 40-3 |
| 18-5 | 22-6 | 24-5 | 28-8 | 32-1 | 40-4 |
| 18-9 | 22-12 | 24-6 | 28-9 | 32-3 | 40-5 |
| 18-13 | 22-14 | 24-7 | 28-10 | 32-6 | 40-6 |
| 18-14 | 22-15 | 24-12 | 28-11 | 32-9 | 40-7 |
| 20-7 | 22-17 | 24-16 | 28-15 | 32-13 | 40-11 |
| 20-8 | 22-18 | 24-20 | 28-16 | 32-22 | |
| 20-9 | 22-19 | 24-21 | 28-17 | 36-7 | |
| 20-14 | 22-21 | 24-28 | 28-19 | 36-8 | |
| 20-16 | 24-1 | 28-1 | 28-20 | 40-2 | |

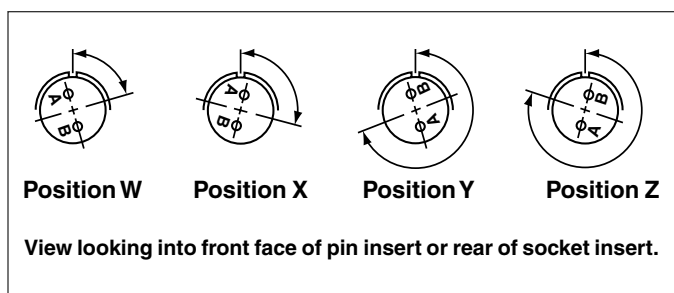

| Insert Arrangement | Degrees | | | |
|--------------------|---------|-----|-----|-----|
| | W | X | Y | Z |
| 12S-3 | 70 | 145 | 215 | 290 |
| 14S-2 | - | 120 | 240 | - |
| 14S-5 | - | 110 | - | - |
| 14S-7 | 90 | 180 | 270 | - |
| 14S-9 | 70 | 145 | 215 | 290 |
| 16S-1 | 80 | - | - | 280 |
| 16S-4 | 35 | 110 | 250 | 325 |
| 16S-8 | - | 170 | 265 | - |
| 16-9 | 35 | 110 | 250 | 325 |
| 16-10 | 90 | 180 | 270 | - |
| 16-11 | 35 | 110 | 250 | 325 |
| 16-13 | 35 | 110 | 250 | 325 |
| 18-1 | 70 | 145 | 215 | 290 |
| 18-4 | 35 | 110 | 250 | 325 |
| 18-8 | 70 | - | - | 290 |
| 18-10 | - | 120 | 240 | - |
| 18-11 | - | 170 | 265 | - |
| 18-12 | 80 | - | - | 280 |
| 18-15 | - | 120 | 240 | - |
| 18-19 | - | 120 | 240 | - |
| 18-22 | 70 | 145 | 215 | 290 |
| 20-4 | 45 | 110 | 250 | - |
| 20-15 | 80 | - | - | 280 |

| Insert Arrangement | Degrees | | | |
|--------------------|---------|-----|-----|-----|
| | W | X | Y | Z |
| 20-17 | 90 | 180 | 270 | - |
| 20-18 | 35 | 110 | 250 | 325 |
| 20-19 | 90 | 180 | 270 | - |
| 20-21 | 35 | 110 | 250 | 325 |
| 20-24 | 35 | 110 | 250 | 325 |
| 20-27 | 35 | 110 | 250 | 325 |
| 20-29 | 80 | - | - | 280 |
| 22-2 | 70 | 145 | 215 | 290 |
| 22-4 | 35 | 110 | 250 | 325 |
| 22-5 | 35 | 110 | 250 | 325 |
| 22-9 | 70 | 145 | 215 | 290 |
| 22-10 | 35 | 110 | 250 | 325 |
| 22-11 | 35 | 110 | 250 | 325 |
| 22-22 | - | 110 | 250 | - |
| 22-23 | 35 | - | 250 | - |
| 22-27 | 80 | - | 250 | 280 |
| 22-36 | 90 | - | 270 | - |
| 24-2 | 80 | - | - | 280 |
| 24-10 | 80 | - | - | 280 |
| 24-11 | 35 | 110 | 250 | 325 |
| 24-22 | 45 | 110 | 250 | - |
| 24-27 | 80 | - | - | 280 |
| 24-80 | 35 | 145 | 240 | 300 |

| Insert Arrangement | Degrees | | | |
|--------------------|---------|-----|-----|-----|
| | W | X | Y | Z |
| 28-2 | 35 | 110 | 250 | 325 |
| 28-3 | 70 | 145 | 215 | 290 |
| 28-5 | 35 | 110 | 250 | 325 |
| 28-12 | 90 | 180 | 270 | - |
| 28-18 | 70 | 145 | 215 | 290 |
| 28-22 | 70 | 145 | 215 | 290 |
| 32-2 | 70 | 145 | 215 | 290 |
| 32-7 | 80 | 125 | 235 | 280 |
| 32-15 | 35 | 110 | 250 | 280 |
| 32-17 | 45 | 110 | 250 | - |
| 32-73 | 36 | - | - | - |
| 36-3 | 70 | 145 | 215 | 290 |
| 36-5 | - | 120 | 240 | - |
| 36-6 | 35 | 110 | 250 | 325 |
| 36-9 | 80 | 125 | 235 | 280 |
| 36-10 | 80 | 125 | 235 | 280 |
| 36-15 | 60 | 125 | 245 | 305 |
| 36-52 | 72 | 144 | 216 | 288 |
| 36-66 | 110 | 250 | 260 | 280 |
| 40-1 | 65 | 130 | 235 | 300 |
| 40-9 | 65 | 125 | 255 | 310 |
| 40-10 | 65 | 125 | 255 | 310 |
| 40-56 | 72 | 144 | 216 | 288 |
| 40-62 | 30 | 130 | 220 | 290 |

MIL-DTL-5015 Crimp Rear Release

How to Order

| | 1. | 2. | 3. | 4. | 5. | 6. | 7. |
|---|----------------|-------------|---------------|-------------------------------|---------------|---------------------|---------------------|
| MIL-DTL-5015 with rear release crimp contacts | Connector Type | Shell Style | Service class | Shell Size-Insert Arrangement | Contact Types | Alternate Positions | Modification Number |
| MILITARY | MS | 3456 | L | 16S-8 | P | W | NA |
| COMMERCIAL | 944 | 6 | F | 16S-8 | P | W | (XXX) |

Step 1. Military Connector Type

| | |
|-----------|------------------------------|
| MS | Designates Military Standard |
|-----------|------------------------------|

Step 2. Select a Shell Style

THREADED COUPLING CONNECTORS

| | |
|-------------|--|
| 3450 | Wall mounting receptacle |
| 3451 | Cable connecting receptacle |
| 3452 | Box mounting receptacle |
| 3454 | Jam nut receptacle |
| 3456 | Straight plug |
| 3459 | Straight plug with self-locking coupling nut |

Step 3. Select a Service Class

| | |
|---|--|
| L | Aluminum shell, electroless nickel finish, fluid resistant insert |
| W | Aluminum shell, cadmium olive drab finish, fluid resistant insert |
| LS | Stainless steel shell, passivated, fluid resistant insert |
| Firewall Styles only available for 3450, 3456, 3459 per mil spec: | |
| KT | Firewall, steel shell, cadmium/olive drab finish, non-flammable hard dielectric and fluid resistant insert |
| KS | Firewall, stainless steel shell, passivated, non-flammable hard dielectric and fluid resistant insert |

Note: Class L inactivates older Class U.

Class K is inactive and has been replaced by Class KT for all applications.

Step 4. Select a Shell Size & Insert Arrangement see pages 434, 435

First number represents Shell Size, second number is the Insert Arrangement.

Step 5. Select a Contact Type

| | |
|----------|--------------|
| | Designates |
| P | Pin |
| S | Socket |
| A | Less pins |
| B | Less sockets |

Step 6. Alternate Positions

“W”, “X”, “Y”, “Z” designate that insert is rotated in its shell from normal position. No letter required for normal (no rotation) position. See page 446 for description of alternate positions.

Step 1. Select a Commercial Connector Type

| | |
|------------|---|
| 944 | Designates Amphenol/Matrix Commercial Series |
| 981 | Designates self locking/Quick disconnect (+)(-) lanyard |

Step 2. Select a Shell Style

THREADED COUPLING CONNECTORS

| | |
|---|--|
| 0 | Wall mounting receptacle |
| 1 | Cable connecting receptacle |
| 2 | Box mounting receptacle |
| 4 | Jam nut receptacle |
| 6 | Straight plug |
| Self Locking/Quick disconnect (981) styles: | |
| 6 | Straight plug with self-locking coupling nut |
| 7 | Quick disconnect plug with lanyard |
| 8 | Quick disconnect plug without lanyard |

Step 3. Select a Service Class

| | |
|-----------|--|
| A | Aluminum shell, black anodize finish, fluid resistant insert (not MIL-Spec) |
| F | Aluminum shell, electroless nickel finish, fluid resistant insert |
| W | Aluminum shell, cadmium olive drab finish, fluid resistant insert |
| FS | Stainless steel shell, passivated, fluid resistant insert |
| RS | Fluid resistant insert |
| KT | Firewall, steel shell, cadmium/olive drab finish, non-flammable hard dielectric and fluid resistant insert |
| KS | Firewall, stainless steel shell, passivated, non-flammable hard dielectric and fluid resistant insert |

Step 4. Select a Shell Size & Insert Arrangement see pages 434, 435

First number represents Shell Size, second number is the Insert Arrangement.

Step 5. Select a Contact Type

| | |
|----------|------------|
| | Designates |
| P | Pin |
| S | Socket |

Step 6. Alternate Positions

“W”, “X”, “Y”, “Z” designate that insert is rotated in its shell from normal position. No letter required for normal (no rotation) position. See page 446 for description of alternate positions.

Step 7. Modification Number

Consult Amphenol Aerospace for information.

For strain reliefs use the following modification codes:

- (189) E-nut M85049/31 configuration
- (190) Straight strain relief M85049/52 configuration
- (191) 90° strain relief M85049/51 configuration

38999

III

HD

Dualok

II

I

SJT

Accessories

Aquacon

Herm/Seal

PCB

HIGH SPEED

Fiber Optics

Contacts
Connectors
Cables

EMI Filter
Transient

26482
Matrix 2

83723 III
Matrix | Pyle

26500
Pyle

5015
Crimp Rear Release
Matrix

22992
Class 1

Back-Shell's

Options
Others

38999

PART # Receptacle Shell, Flange Wall Mount, Threaded Coupling.
To complete, see how to order page 447

| MIL-DTL-5015 | Connector Type | Shell Style | Service Class | Shell Size-Insert Arrangement | Contact Type | Alternate Rotation | Modification Number |
|-------------------|----------------|-------------|---------------|-------------------------------|--------------|--------------------|---------------------|
| Military | MS | 3450 | <i>L</i> | <i>16S-8</i> | <i>P</i> | <i>W</i> | NA |
| Commercial | 944 | 0 | <i>F</i> | <i>16S-8</i> | <i>P</i> | <i>W</i> | <i>xxx</i> |

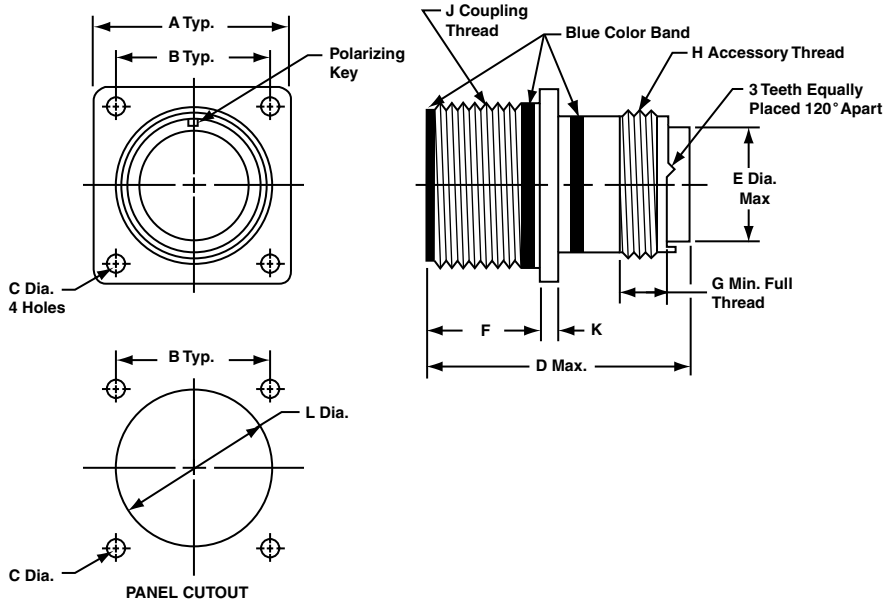

| Shell Size* | A ±.031 | B | C Dia. +.010 -0.005 | | D Max. | | E Dia. Max. | F | G Min. | H Thread Class 2A | J Thread Class 2A | K | L Dia. ±.010 |
|-------------|---------|-------|---------------------|---------|-----------------------|-----------------------|-------------|-----------|--------|-------------------|-------------------|------|--------------|
| | | | Class A, F, R, W | Class K | Size 16 & 12 Contacts | Size 8, 4, 0 Contacts | | | | | | | |
| 8S | .875 | .594 | .120 | .150 | 2.031 | — | .305 | .593/.562 | .290 | .5000-20 UNEF | .5000-28 UNEF | .083 | .562 |
| 10S | 1.000 | .719 | .120 | .150 | 2.031 | — | .405 | .593/.562 | .290 | .6250-24 UNEF | .6250-24 UNEF | .083 | .688 |
| 10SL | 1.000 | .719 | .120 | .150 | 2.031 | — | .405 | .593/.562 | .290 | .6250-24 UNEF | .6250-24 UNEF | .083 | .688 |
| 12 | 1.094 | .812 | .120 | .150 | 2.125 | — | .549 | .781/.750 | .290 | .7500-20 UNEF | .7500-20 UNEF | .083 | .812 |
| 12S | 1.094 | .812 | .120 | .150 | 2.031 | — | .549 | .593/.562 | .290 | .7500-20 UNEF | .7500-20 UNEF | .083 | .812 |
| 14 | 1.188 | .906 | .120 | .150 | 2.125 | — | .665 | .781/.750 | .290 | .8750-20 UNEF | .8750-20 UNEF | .083 | .938 |
| 14S | 1.188 | .906 | .120 | .150 | 2.031 | — | .665 | .593/.562 | .290 | .8750-20 UNEF | .8750-20 UNEF | .083 | .938 |
| 16 | 1.281 | .969 | .120 | .150 | 2.125 | 2.500 | .790 | .781/.750 | .290 | 1.0000-20 UNEF | 1.0000-20 UNEF | .083 | 1.062 |
| 16S | 1.281 | .969 | .120 | .150 | 2.031 | — | .790 | .593/.562 | .290 | 1.0000-20 UNEF | 1.0000-20 UNEF | .083 | 1.062 |
| 18 | 1.375 | 1.062 | .120 | .177 | 2.125 | 2.500 | .869 | .781/.750 | .290 | 1.0625-18 UNEF | 1.1250-18 UNEF | .125 | 1.188 |
| 20 | 1.500 | 1.156 | .120 | .177 | 2.125 | 2.500 | .994 | .781/.750 | .290 | 1.1875-18 UNEF | 1.2500-18 UNEF | .125 | 1.312 |
| 22 | 1.625 | 1.250 | .120 | .177 | 2.125 | 2.500 | 1.119 | .781/.750 | .290 | 1.3125-18 UNEF | 1.3750-18 UNEF | .125 | 1.438 |
| 24 | 1.750 | 1.375 | .147 | .177 | 2.125 | 2.500 | 1.244 | .843/.812 | .290 | 1.4375-18 UNEF | 1.5000-18 UNEF | .125 | 1.562 |
| 28 | 2.000 | 1.562 | .147 | .177 | 2.125 | 2.500 | 1.465 | .843/.812 | .467 | 1.7500-18 UNS | 1.7500-18 UNS | .125 | 1.812 |
| 32 | 2.250 | 1.750 | .173 | .209 | 2.125 | 2.500 | 1.715 | .906/.875 | .467 | 2.0000-18 UNS | 2.0000-18 UNS | .125 | 2.062 |
| 36 | 2.500 | 1.938 | .173 | .209 | 2.125 | 2.500 | 1.930 | .906/.875 | .467 | 2.2500-16 UN | 2.2500-16 UN | .125 | 2.312 |
| 40 | 2.750 | 2.188 | .173 | .209 | 2.125 | 2.500 | 2.145 | .906/.875 | .467 | 2.5000-16 UN | 2.5000-16 UN | .125 | 2.562 |

* Consult Amphenol Aerospace for availability of shell sizes 44 and 48.

MS3451, MIL-DTL-5015 Crimp Rear Release Cable Connecting Receptacle

PART # Receptacle Shell, Cable Connecting, Threaded Coupling.
To complete, see how to order page 447

| MIL-DTL-5015 | Connector Type | Connector Style | Service Class | Shell Size- Insert Arrangement | Contact Type | Insert Rotation | Modification Number |
|-------------------|----------------|-----------------|---------------|-----------------------------------|--------------|-----------------|---------------------|
| Military | MS | 3451 | <i>L</i> | <i>16S-8</i> | <i>P</i> | <i>W</i> | NA |
| Commercial | 944 | 1 | <i>F</i> | <i>16S-8</i> | <i>P</i> | <i>W</i> | <i>xxx</i> |

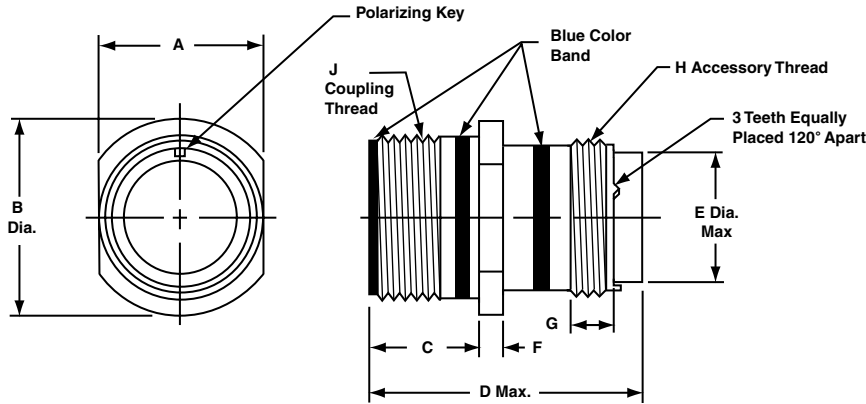

| Shell Size | A | B Dia. ±.031 | C | D Max. | | E Dia. Max. | F ±.015 | G Min. | H Thread Class 2A | J Thread Class 2A |
|------------|-------------|--------------|-----------|-----------------------|-----------------------|-------------|---------|--------|-------------------|-------------------|
| | | | | Size 16 & 12 Contacts | Size 8, 4, 0 Contacts | | | | | |
| 8S | .504/.496 | .729 | .577/.562 | 2.031 | — | .305 | .083 | .290 | .5000-20 UNEF | .5000-28 UNEF |
| 10S | .629/.621 | .854 | .577/.562 | 2.031 | — | .405 | .083 | .290 | .6250-24 UNEF | .6250-24 UNEF |
| 10SL | .629/.621 | .854 | .577/.562 | 2.031 | — | .405 | .083 | .290 | .6250-24 UNEF | .6250-24 UNEF |
| 12 | .754/.746 | .974 | .765/.750 | 2.125 | — | .549 | .083 | .290 | .7500-20 UNEF | .7500-20 UNEF |
| 12S | .754/.746 | .974 | .577/.562 | 2.031 | — | .549 | .083 | .290 | .7500-20 UNEF | .7500-20 UNEF |
| 14 | .879/.871 | 1.099 | .765/.750 | 2.125 | — | .665 | .083 | .290 | .8750-20 UNEF | .8750-20 UNEF |
| 14S | .879/.871 | 1.099 | .577/.562 | 2.031 | — | .665 | .083 | .290 | .8750-20 UNEF | .8750-20 UNEF |
| 16 | 1.005/.996 | 1.224 | .765/.750 | 2.125 | 2.500 | .790 | .083 | .290 | 1.0000-20 UNEF | 1.0000-20 UNEF |
| 16S | 1.005/.996 | 1.224 | .577/.562 | 2.031 | — | .790 | .083 | .290 | 1.0000-20 UNEF | 1.0000-20 UNEF |
| 18 | 1.131/1.121 | 1.349 | .765/.750 | 2.125 | 2.500 | .869 | .125 | .290 | 1.0625-18 UNEF | 1.1250-18 UNEF |
| 20 | 1.256/1.246 | 1.474 | .765/.750 | 2.125 | 2.500 | .994 | .125 | .290 | 1.1875-18 UNEF | 1.2500-18 UNEF |
| 22 | 1.381/1.371 | 1.599 | .765/.750 | 2.125 | 2.500 | 1.119 | .125 | .290 | 1.3125-18 UNEF | 1.3750-18 UNEF |
| 24 | 1.506/1.496 | 1.715 | .827/.812 | 2.125 | 2.500 | 1.244 | .125 | .290 | 1.4375-18 UNEF | 1.5000-18 UNEF |
| 28 | 1.756/1.746 | 1.974 | .827/.812 | 2.125 | 2.500 | 1.465 | .125 | .467 | 1.7500-18 UNS | 1.7500-18 UNS |
| 32 | 2.007/1.996 | 2.224 | .890/.870 | 2.125 | 2.500 | 1.715 | .125 | .467 | 2.0000-18 UNS | 2.0000-18 UNS |
| 36 | 2.257/2.246 | 2.474 | .890/.870 | 2.125 | 2.500 | 1.930 | .125 | .467 | 2.2500-16 UN | 2.2500-16 UN |
| 40 | 2.511/2.456 | 2.724 | .890/.870 | 2.125 | 2.500 | 2.145 | .125 | .467 | 2.5000-16 UN | 2.5000-16 UN |

* Consult Amphenol Aerospace for availability of shell sizes 44 and 48.

38999

- III
- HD
- Dualok
- II
- I
- SJT
- Accessories
- Aquacon
- Herm/Seal
- PCB

- HIGH SPEED
- Fiber Optics
- Contacts Connectors Cables

EMI Filter Transient

26482 Matrix 2

83723 III Matrix | Pyle

26500 Pyle

5015 Crimp Rear Release Matrix

22992 Class 1

Back-Shell's

Options Others

38999

- III
- HD
- Dualok
- II
- I
- SJT
- Accessories
- Aquacon
- Herm/Seal
- PCB

HIGH SPEED

- Fiber Optics
- Contacts Connectors Cables

EMI Filter Transient

26482 Matrix 2

83723 III Matrix | Pyle

26500 Pyle

5015 Crimp Rear Release Matrix

22992 Class I

Back-Shells

Options Others

PART # Receptacle Shell, Flange Mount, Threaded Coupling.
To complete, see how to order page 447

| MIL-DTL-5015 Connector Type | Shell Style | Service Class | Shell Size-Insert Arrangement | Contact Type | Alternate Rotation | Modification Number |
|-----------------------------|-------------|---------------|-------------------------------|--------------|--------------------|-------------------------|
| Military | MS | 3452 | <i>L</i> | <i>16S-8</i> | <i>P</i> | <i>W</i> |
| Commercial | 944 | 2 | <i>F</i> | <i>16S-8</i> | <i>P</i> | <i>W</i> |
| | | | | | | NA <i>xxx</i> |

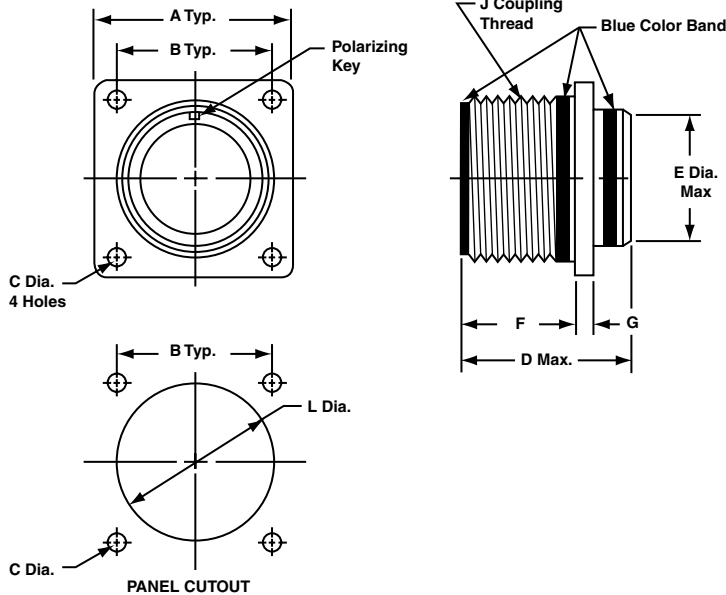

| Shell Size* | A ±.031 | B | C Dia. | D Max. | | E Dia. ±.016 | F | G ±.015 | J Thread Class 2A | L Dia. ±.010 |
|-------------|---------|-------|-----------|-----------------------|-----------------------|--------------|-----------|---------|-------------------|--------------|
| | | | | Size 16 & 12 Contacts | Size 8, 4, 0 Contacts | | | | | |
| 8S | .875 | .594 | .130/.115 | 1.662 | — | .500 | .578/.562 | .083 | .5000-28 UNEF | .562 |
| 10S | 1.000 | .719 | .130/.115 | 1.662 | — | .625 | .578/.562 | .083 | .6250-24 UNEF | .688 |
| 10SL | 1.000 | .719 | .130/.115 | 1.662 | — | .625 | .578/.562 | .083 | .6250-24 UNEF | .688 |
| 12 | 1.094 | .812 | .130/.115 | 1.662 | — | .750 | .765/.750 | .083 | .7500-20 UNEF | .812 |
| 12S | 1.094 | .812 | .130/.115 | 1.662 | — | .750 | .578/.562 | .083 | .7500-20 UNEF | .812 |
| 14 | 1.188 | .906 | .130/.115 | 1.662 | — | .875 | .765/.750 | .083 | .8750-20 UNEF | .938 |
| 14S | 1.188 | .906 | .130/.115 | 1.662 | — | .875 | .577/.562 | .083 | .8750-20 UNEF | .938 |
| 16 | 1.281 | .969 | .130/.115 | 1.662 | 1.937 | 1.000 | .765/.750 | .083 | 1.0000-20 UNEF | 1.062 |
| 16S | 1.281 | .969 | .130/.115 | 1.662 | — | 1.000 | .577/.562 | .083 | 1.0000-20 UNEF | 1.062 |
| 18 | 1.375 | 1.062 | .130/.115 | 1.662 | 1.937 | 1.062 | .765/.750 | .125 | 1.1250-18 UNEF | 1.188 |
| 20 | 1.500 | 1.156 | .130/.115 | 1.662 | 1.937 | 1.187 | .765/.750 | .125 | 1.2500-18 UNEF | 1.312 |
| 22 | 1.625 | 1.250 | .130/.115 | 1.662 | 1.937 | 1.312 | .765/.750 | .125 | 1.3750-18 UNEF | 1.438 |
| 24 | 1.750 | 1.375 | .157/.142 | 1.662 | 1.937 | 1.437 | .827/.812 | .125 | 1.5000-18 UNEF | 1.562 |
| 28 | 2.000 | 1.562 | .157/.142 | 1.662 | 1.937 | 1.750 | .827/.812 | .125 | 1.7500-18 UNS | 1.812 |
| 32 | 2.250 | 1.750 | .183/.168 | 1.662 | 1.937 | 2.000 | .988/.875 | .125 | 2.0000-18 UNS | 2.062 |
| 36 | 2.500 | 1.938 | .183/.168 | 1.662 | 1.937 | 2.250 | .988/.875 | .125 | 2.2500-16 UN | 2.312 |
| 40 | 2.750 | 2.188 | .183/.168 | 1.662 | 1.937 | 2.500 | .988/.875 | .125 | 2.5000-16 UN | 2.562 |

* Consult Amphenol Aerospace for availability of shell sizes 44 and 48.

MS3454, MIL-DTL-5015 Crimp Rear Release Jam Nut Receptacle

PART # Receptacle Shell, Jam Nut Mount, Threaded Coupling
To complete, see how to order page 447

| MIL-DTL-5015 | Connector Type | Shell Style | Service Class | Shell Size—Insert Arrangement | Contact Type | Alternate Rotation | Modification Number |
|-------------------|----------------|-------------|---------------|-------------------------------|--------------|--------------------|---------------------|
| Military | MS | 3454 | L | 16S-8 | P | W | NA |
| Commercial | 944 | 4 | F | 16S-8 | P | W | xxx |

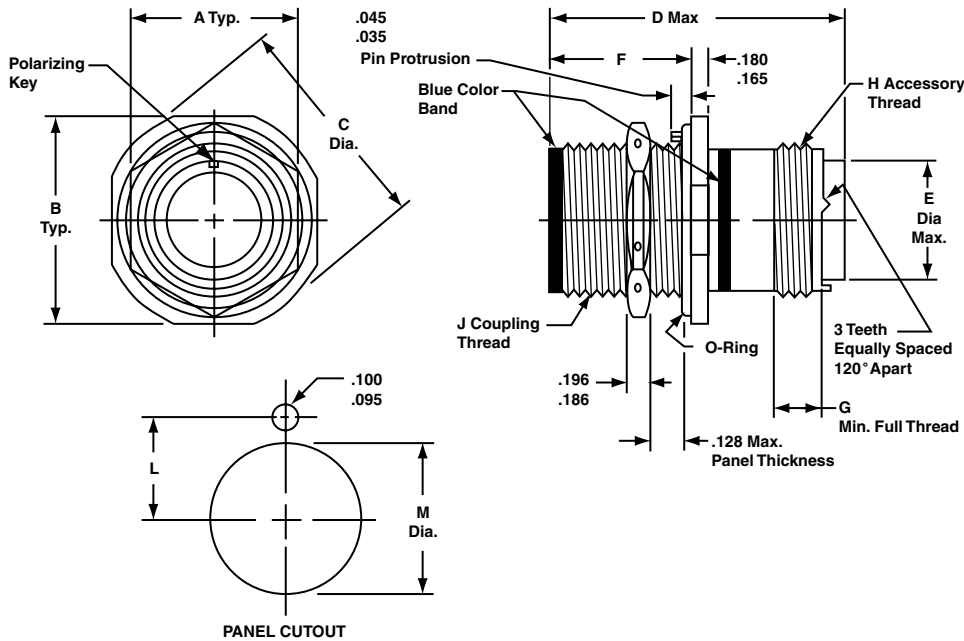

| Shell Size* | A ±.010 | B ±.005 | C Dia. ±.005 | D Max. | | E Dia. Max. | F ±.005 | G Min. | H Thread Class 2A | J Thread Class 2A | Panel Cutout Dimensions | |
|-------------|---------|---------|--------------|-----------------------|-----------------------|-------------|---------|--------|-------------------|-------------------|-------------------------|---------------------|
| | | | | Size 16 & 12 Contacts | Size 8, 4, 0 Contacts | | | | | | L ±.005 | M Dia. +.015 - .000 |
| 8S | .687 | 1.187 | 1.272 | 2.031 | — | .305 | .720 | .290 | .5000-20 UNEF | .5000-28 UNEF | .323 | .505 |
| 10S | .812 | 1.312 | 1.397 | 2.031 | — | .405 | .720 | .290 | .6250-24 UNEF | .6250-24 UNEF | .385 | .630 |
| 10SL | .812 | 1.312 | 1.397 | 2.031 | — | .405 | .720 | .290 | .6250-24 UNEF | .6250-24 UNEF | .385 | .630 |
| 12 | .937 | 1.437 | 1.522 | 2.125 | — | .549 | .970 | .290 | .7500-20 UNEF | .7500-20 UNEF | .448 | .755 |
| 12S | .937 | 1.437 | 1.522 | 2.031 | — | .549 | .720 | .290 | .7500-20 UNEF | .7500-20 UNEF | .448 | .755 |
| 14 | 1.125 | 1.562 | 1.647 | 2.125 | — | .665 | .970 | .290 | .8750-20 UNEF | .8750-20 UNEF | .510 | .880 |
| 14S | 1.125 | 1.562 | 1.647 | 2.031 | — | .665 | .720 | .290 | .8750-20 UNEF | .8750-20 UNEF | .510 | .880 |
| 16 | 1.250 | 1.687 | 1.772 | 2.125 | 2.500 | .790 | .970 | .290 | 1.0000-20 UNEF | 1.0000-20 UNEF | .573 | 1.005 |
| 16S | 1.250 | 1.687 | 1.772 | 2.031 | — | .790 | .720 | .290 | 1.0000-20 UNEF | 1.0000-20 UNEF | .573 | 1.005 |
| 18 | 1.375 | 1.812 | 1.897 | 2.125 | 2.500 | .869 | .970 | .290 | 1.0625-18 UNEF | 1.1250-18 UNEF | .635 | 1.130 |
| 20 | 1.500 | 1.937 | 2.022 | 2.125 | 2.500 | .994 | .970 | .290 | 1.1875-18 UNEF | 1.2500-18 UNEF | .698 | 1.255 |
| 22 | 1.625 | 2.156 | 2.241 | 2.125 | 2.500 | 1.119 | .970 | .290 | 1.3125-18 UNEF | 1.3750-18 UNEF | .760 | 1.380 |
| 24 | 1.750 | 2.281 | 2.366 | 2.125 | 2.500 | 1.244 | .970 | .290 | 1.4375-18 UNEF | 1.5000-18 UNEF | .823 | 1.505 |
| 28 | 2.000 | 2.531 | 2.616 | 2.125 | 2.500 | 1.465 | .970 | .467 | 1.7500-18 UNS | 1.7500-18 UNS | .948 | 1.755 |
| 32 | 2.375 | 2.781 | 2.866 | 2.125 | 2.500 | 1.715 | .970 | .467 | 2.0000-18 UNS | 2.0000-18 UNS | 1.073 | 2.005 |
| 36 | 2.625 | 3.031 | 3.116 | 2.125 | 2.500 | 1.930 | .970 | .467 | 2.2500-16 UN | 2.2500-16 UN | 1.198 | 2.255 |
| 40 | 2.875 | 3.281 | 3.366 | 2.125 | 2.500 | 2.145 | .970 | .467 | 2.5000-16 UN | 2.5000-16 UN | 1.323 | 2.505 |

* Consult Amphenol Aerospace for availability of shell sizes 44 and 48.

38999

- III
- HD
- Dualok
- II
- I
- SJT
- Accessories
- Aquacon
- Herm/Seal
- PCB

- HIGH SPEED
- Fiber Optics
- Contacts Connectors Cables

EMI Filter Transient

26482 Matrix 2

83723 III Matrix | Pyle

26500 Pyle

5015 Crimp Rear Release Matrix

22992 Class 1

Back-Shell's

Options Others

38999
III
HD
Dualok
II
I
SJT
Accessories
Aquacon
Herm/Seal
PCB

HIGH SPEED
Fiber Optics
Contacts
Connectors
Cables

EMI Filter
Transient

26482
Matrix 2

83723 III
Matrix | Pyle

26500
Pyle

5015
Crimp Rear Release
Matrix

22992
Class I

Back-
Shells

Options
Others

PART # Plug Shell, Threaded Coupling.

To complete, see how to order page 447

| | | | | | | | |
|-------------------|----------------|-------------|---------------|-------------------------------|--------------|--------------------|---------------------|
| MIL-DTL-5015 | Connector Type | Shell Style | Service Class | Shell Size—Insert Arrangement | Contact Type | Alternate Rotation | Modification Number |
| Military | MS | 3456 | <i>L</i> | <i>16S-8</i> | <i>P</i> | <i>W</i> | NA |
| Commercial | 944 | 6 | <i>F</i> | <i>16S-8</i> | <i>P</i> | <i>W</i> | <i>xxx</i> |

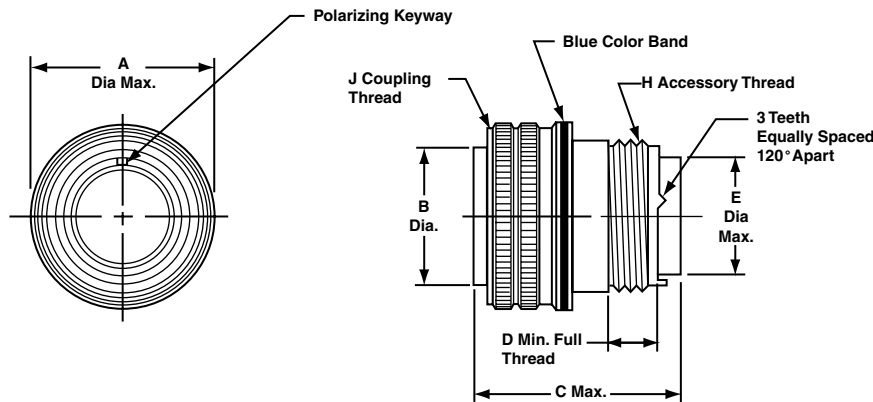

| Shell Size* | A Dia. Max. | B Dia. ±.005 | C Max. | | D Min. | E Dia. Max. | H Thread Class 2A | J Thread Class 2B |
|-------------|-------------|--------------|-----------------------|-----------------------|--------|-------------|-------------------|-------------------|
| | | | Size 16 & 12 Contacts | Size 8, 4, 0 Contacts | | | | |
| 8S | .844 | .360 | 2.031 | — | .290 | .305 | .5000-20 UNF | .5000-28 UNEF |
| 10S | .969 | .435 | 2.031 | — | .290 | .405 | .6250-24 UNEF | .6250-24 UNEF |
| 10SL | .969 | .441** | 2.031 | — | .290 | .405 | .6250-24 UNEF | .6250-24 UNEF |
| 12 | 1.062 | .550 | 2.125 | — | .290 | .549 | .7500-20 UNEF | .7500-20 UNEF |
| 12S | 1.062 | .550 | 2.031 | — | .290 | .549 | .7500-20 UNEF | .7500-20 UNEF |
| 14 | 1.156 | .670 | 2.125 | — | .290 | .665 | .8750-20 UNEF | .8750-20 UNEF |
| 14S | 1.156 | .670 | 2.031 | — | .290 | .665 | .8750-20 UNEF | .8750-20 UNEF |
| 16 | 1.250 | .800 | 2.125 | 2.500 | .290 | .790 | 1.0000-20 UNEF | 1.0000-20 UNEF |
| 16S | 1.250 | .800 | 2.031 | — | .290 | .790 | 1.0000-20 UNEF | 1.0000-20 UNEF |
| 18 | 1.344 | .925 | 2.125 | 2.500 | .290 | .869 | 1.0625-18 UNEF | 1.1250-18 UNEF |
| 20 | 1.469 | 1.045 | 2.125 | 2.500 | .290 | .994 | 1.1875-18 UNEF | 1.2500-18 UNEF |
| 22 | 1.594 | 1.170 | 2.125 | 2.500 | .290 | 1.119 | 1.3125-18 UNEF | 1.3750-18 UNEF |
| 24 | 1.719 | 1.295 | 2.125 | 2.500 | .290 | 1.244 | 1.4375-18 UNEF | 1.5000-18 UNEF |
| 28 | 1.969 | 1.515 | 2.125 | 2.500 | .467 | 1.465 | 1.7500-18 UNS | 1.7500-18 UNS |
| 32 | 2.219 | 1.765 | 2.125 | 2.500 | .467 | 1.715 | 2.0000-18 UNS | 2.0000-18 UNS |
| 36 | 2.469 | 1.975 | 2.125 | 2.500 | .467 | 1.930 | 2.2500-16 UN | 2.2500-16 UN |
| 40 | 2.719 | 2.225 | 2.125 | 2.500 | .467 | 2.145 | 2.5000-16 UN | 2.5000-16 UN |

* Consult Amphenol Aerospace for availability of shell sizes 44 and 48.
** Tolerance on this dimension is +.000 –.006

MS3459, MIL-DTL-5015 Crimp Rear Release Straight Plug with Self-locking Coupling Nut

PART # Plug Shell, Self-Locking, Threaded Coupling
To complete, see how to order page 447

| MIL-DTL-5015 | Connector Type | Shell Style | Service Class | Shell Size-Insert Arrangement | Contact Type | Alternate Rotation | Modification Number |
|-------------------|----------------|-------------|---------------|-------------------------------|--------------|--------------------|---------------------|
| Military | MS | 3459 | <i>L</i> | <i>16S-8</i> | <i>P</i> | <i>W</i> | NA |
| Commercial | 981 | 6 | <i>F</i> | <i>16S-8</i> | <i>P</i> | <i>W</i> | <i>xxx</i> |

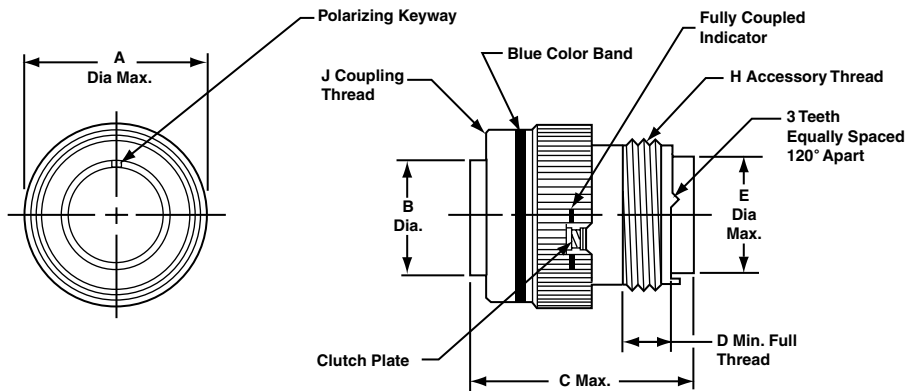

| Shell Size* | A Dia. Max. | B Dia. ±.005 | C Max. | | D Min. | E Dia. Max. | H Thread Class 2A | J Thread Class 2B |
|-------------|-------------|--------------|-----------------------|-----------------------|--------|-------------|-------------------|-------------------|
| | | | Size 16 & 12 Contacts | Size 8, 4, 0 Contacts | | | | |
| 8S | .963 | .360 | 1.510 | - | .290 | .305 | .5000-20 UNEF | .5000-28 UNEF |
| 10S | 1.088 | .435 | 1.510 | - | .290 | .405 | .6250-24 UNEF | .6250-24 UNEF |
| 10SL | 1.088 | .441** | 1.510 | - | .290 | .405 | .6250-24 UNEF | .6250-24 UNEF |
| 12 | 1.213 | .550 | 1.780 | - | .290 | .549 | .7500-20 UNEF | .7500-20 UNEF |
| 12S | 1.213 | .550 | 1.510 | - | .290 | .549 | .7500-20 UNEF | .7500-20 UNEF |
| 14 | 1.358 | .670 | 1.780 | - | .290 | .665 | .8750-20 UNEF | .8750-20 UNEF |
| 14S | 1.358 | .670 | 1.510 | - | .290 | .665 | .8750-20 UNEF | .8750-20 UNEF |
| 16 | 1.463 | .800 | 1.780 | 2.500 | .290 | .790 | 1.0000-20 UNEF | 1.0000-20 UNEF |
| 16S | 1.463 | .800 | 1.510 | - | .290 | .790 | 1.0000-20 UNEF | 1.0000-20 UNEF |
| 18 | 1.588 | .925 | 1.850 | 2.500 | .290 | .869 | 1.0625-18 UNEF | 1.1250-18 UNEF |
| 20 | 1.713 | 1.045 | 1.850 | 2.500 | .290 | .994 | 1.1875-18 UNEF | 1.2500-18 UNEF |
| 22 | 1.788 | 1.170 | 1.850 | 2.500 | .290 | 1.119 | 1.3125-18 UNEF | 1.3750-18 UNEF |
| 24 | 1.963 | 1.295 | 1.850 | 2.500 | .290 | 1.244 | 1.4375-18 UNEF | 1.5000-18 UNEF |
| 28 | 2.213 | 1.515 | 1.850 | 2.500 | .467 | 1.465 | 1.7500-18 UNS | 1.7500-18 UNS |
| 32 | 2.463 | 1.765 | 1.850 | 2.500 | .467 | 1.715 | 2.0000-18 UNS | 2.0000-18 UNS |
| 36 | 2.713 | 1.975 | 1.850 | 2.500 | .467 | 1.930 | 2.2500-16 UN | 2.2500-16 UN |
| 40 | 2.963 | 2.225 | 1.850 | 2.500 | .467 | 2.145 | 2.5000-16 UN | 2.5000-16 UN |

* Consult Amphenol Aerospace for availability of shell sizes 44 and 48.
** Tolerance on this dimension is +.000 - .006

38999

III

HD

Dualok

II

I

SJT

Accessories

Aquacon

Herm/Seal

PCB

HIGH SPEED

Fiber Optics

Contacts
Connectors
Cables

EMI Filter
Transient

26482
Matrix 2

83723 III
Matrix | Pyle

26500
Pyle

5015
Crimp Rear
Release
Matrix

22992
Class 1

Back-
Shells

Options
Others

PART # Plug Shell, Quick Disconnect, Push-pull Coupling
To complete, see how to order page 447

| MIL-DTL-5015 | Connector Type | Shell Style | Service Class | Shell Size— Insert Arrangement | Contact Type | Alternate Rotation | Modification Number |
|--------------|----------------|-------------|---------------|-----------------------------------|--------------|--------------------|---------------------|
| Commercial | 981 | 7 | L | 16S-8 | P | W | xxx |
| Commercial | 981 | 8 | F | 16S-8 | P | W | xxx |

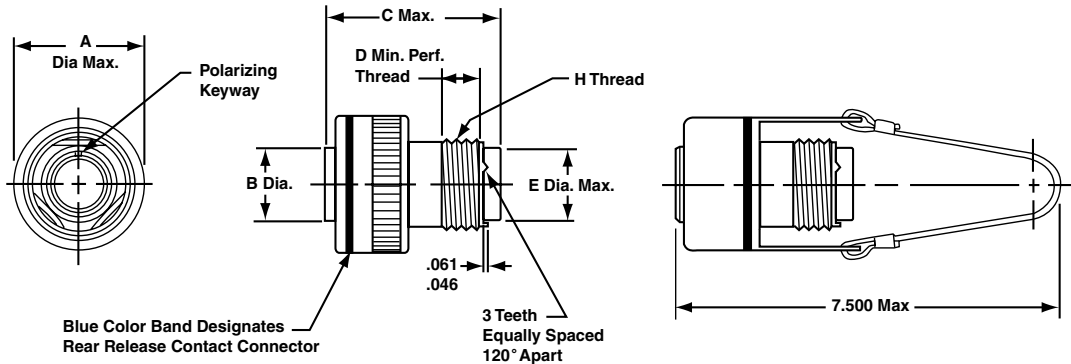

9818 Connector

9817 Connector with Lanyard

| Shell Size* | A Dia. Max. | B Dia. | C Max. | | D Min. | E Dia. Max. | H Thread Class 2A | Amphenol/ Matrix Part Number for Adapter Ring |
|-------------|-------------|--------|-----------------------|-----------------------|--------|-------------|-------------------|---|
| | | | Size 16 & 12 Contacts | Size 8, 4, 0 Contacts | | | | |
| 8S | 1.087 | .360 | 2.031 | — | .290 | .305 | .5000-20 UNF | 2500-008-0X08 |
| 10S | 1.224 | .435 | 2.031 | — | .290 | .405 | .6250-24 UNEF | 2500-008-0X10 |
| 10SL | 1.224 | .441 | 2.031 | — | .290 | .405 | .6250-24 UNEF | 2500-008-0X10 |
| 12 | 1.355 | .550 | 2.125 | — | .290 | .549 | .7500-20 UNEF | 2500-008-0X12 |
| 12S | 1.355 | .550 | 2.031 | — | .290 | .549 | .7500-20 UNEF | 2500-008-0X13 |
| 14 | 1.482 | .670 | 2.125 | — | .290 | .665 | .8750-20 UNEF | 2500-008-0X14 |
| 14S | 1.482 | .670 | 2.031 | — | .290 | .665 | .8750-20 UNEF | 2500-008-0X15 |
| 16 | 1.609 | .800 | 2.125 | 2.500 | .290 | .790 | 1.0000-20 UNEF | 2500-008-0X16 |
| 16S | 1.609 | .800 | 2.031 | — | .290 | .790 | 1.0000-20 UNEF | 2500-008-0X17 |
| 18 | 1.817 | .925 | 2.125 | 2.500 | .290 | .869 | 1.0625-18 UNEF | 2500-008-0X18 |
| 20 | 1.942 | 1.045 | 2.125 | 2.500 | .290 | .994 | 1.1875-18 UNEF | 2500-008-0X20 |
| 22 | 2.075 | 1.170 | 2.125 | 2.500 | .290 | 1.119 | 1.3125-18 UNEF | 2500-008-0X22 |
| 24 | 2.203 | 1.295 | 2.125 | 2.500 | .290 | 1.244 | 1.4375-18 UNEF | 2500-008-0X24 |
| 28 | 2.516 | 1.515 | 2.125 | 2.500 | .467 | 1.465 | 1.7500-18 UNS | 2500-008-0X28 |
| 32 | 2.735 | 1.765 | 2.125 | 2.500 | .467 | 1.715 | 2.0000-18 UNS | 2500-008-0X32 |
| 36 | 3.015 | 1.975 | 2.125 | 2.500 | .467 | 1.930 | 2.2500-16 UN | 2500-008-0X36 |
| 40 | 3.306 | 2.225 | 2.125 | 2.500 | .467 | 2.145 | 2.5000-16 UN | 2500-008-0X40 |

* Consult Amphenol Aerospace for availability of shell sizes 44 and 48.

Receptacle Adapter Ring

Required to mate the quick disconnect plug with receptacle. Not furnished with the quick disconnect plug and must be ordered separately.

Note: Use Locktite Material on the threads for a permanent installation to the shell.

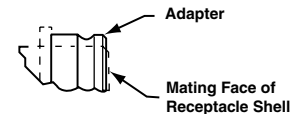

How to Order Adapter Ring

Part Number

2500-008-0 X XX

Shell Size (varies from connector shell size designation, see last column of table at left)

- Finish
- 0 - Electroless Nickel
 - 1 - Black Anodize
 - 2 - Cadmium/Olive Drab
 - 3 - Stainless Steel, Passivated

Amphenol® Matrix 5015 Connector With RADSOK® Contacts

For High Power Applications

- Mil-spec qualified, environmental Matrix MIL-DTL-5015 connectors with improved sealing
- Completely environmentally sealed with contact seals, gaskets, wire seals and insert-to-shell seals
- Special design enhanced with RADSOK contacts in the plug instead of standard rear release crimp contacts
- All the shell styles and finishes of the Matrix 5015 family are available, including firewall styles and non-decoupling styles

RADSOK contacts provide high amperage capability with minimal voltage loss and low insertion forces.

The RADSOK contact has a hyperbolic, stamped grid configuration with the socket circular. As a male pin is inserted, axial members in the female socket deflect, enabling high current flow across the connection with minimal voltage loss.

See pages 561-563 for more information on RADSOK contacts.



38999

| |
|-------------|
| III |
| HD |
| Dualok |
| II |
| I |
| SJT |
| Accessories |
| Aquacon |
| Herm/Seal |
| PCB |

| |
|--------------|
| HIGH SPEED |
| Fiber Optics |
| Contacts |
| Connectors |
| Cables |

EMI Filter
Transient

26482
Matrix 2

83723 III
Matrix | Pyle

26500
Pyle

5015
Crimp Rear
Release
Matrix

22992
Class 1

Back-
Shells

Options
Others

38999
III
HD
Dualok
II
I
SJT
Accessories
Aquacon
Herm/Seal
PCB
HIGH SPEED
Fiber Optics
Contacts Connectors Cables
EMI Filter Transient
26482 Matrix 2
83723 III Matrix | Pyle
26500 Pyle
5015 Crimp Rear Release Matrix
22992 Class I
Back-Shells
Options Others

MS/STANDARD CRIMP REAR RELEASE CONTACTS

| Contact Size | Wire Range | | Socket Contacts | | Pin Contacts | |
|--------------|------------|-----------------|----------------------|-----------------------------|----------------------|-----------------------------|
| | AWG | mm ² | Military Part Number | Amphenol/Matrix Part Number | Military Part Number | Amphenol/Matrix Part Number |
| 16S* | 20-16 | 0.5-1.4 | M39029/30-217 | M5100-033-1601L | M39029/29-212 | M5000-029-0016L |
| 16 | 20-16 | 0.5-1.4 | M39029/30-218 | M5100-033-1602L | M39029/29-212 | M5000-029-0016L |
| 12 | 14-12 | 2-3 | M39029/30-219 | M5100-033-0012 | M39029/29-213 | M5000-029-0012 |
| 8 | 10-8† | 5-8.5 | M39029/30-220 | M5100-033-0008 | M39029/29-214 | M5000-029-0008 |
| 4 | 6-4† | 13-21 | M39029/30-221 | M5100-033-0004 | M39029/29-215 | M5000-029-0004 |
| 0 | 2-0† | 34-60 | M39029/30-222 | M5100-033-0000 | M39029/29-216 | M5000-029-0000 |

* Shorter wire barrel Note: For information on thermocouple contacts, consult Amphenol Aerospace
† Use MS3348 bushing kit to accommodate smaller wire.

CONTACT CURRENT RATING AND RETENTION

| Contact Size** | Current Rating | | Contact Retention | |
|----------------|----------------|-------------------------|-------------------|-------|
| | Amperes Max. | Voltage Drop Millivolts | Axial Load | |
| | | | lb. | N |
| 16 | 13 | 50 | 25 | 111.2 |
| 12 | 23 | 50 | 30 | 133.4 |
| 8 | 46 | 25 | 50 | 222.4 |
| 4 | 80 | 14 | 60 | 266.9 |
| 0 | 150 | 12 | 75 | 333.6 |

** Organize individual circuits to maintain heat rise within operating temperature requirements.

SEALING PLUGS

| Contact Size | Sealing Plugs | |
|--------------|----------------------|-----------------------------|
| | Military Part Number | Amphenol/Matrix Part Number |
| 16S | MS27488-16-3 | 10-405996-163 |
| 16 | MS27488-16-3 | 10-405996-163 |
| 12 | MS27488-12-3 | 10-405996-123 |
| 8 | MS27488-8-3 | 10-405996-083 |
| 4 | MS27488-4-3 | 10-405996-043 |
| 0 | MS27488-0-3 | 10-405996-003 |

CRIMPING TOOLS

| Contact Size | Wire Range | | Finished Wire Dia. Range | | Color Code | Crimping Tool Part Number | Turret or Positioner Part Number |
|--------------|------------|-----------------|--------------------------|------------|-------------|---------------------------|----------------------------------|
| | AWG | mm ² | Inch | mm | | | |
| 16S | 20-16 | 0.5-1.4 | .053-.103 | 1.34-2.62 | Red/White | M22520/1-01 | M22520/1-02 |
| 16 | 20-16 | 0.5-1.4 | .053-.103 | 1.34-2.62 | Blue/White | M22520/1-01 | M22520/1-02 |
| 12 | 14-12 | 2-3 | .085-.158 | 2.15-4.01 | Yell./White | M22520/1-01 | M22520/1-02 |
| 8 | 10-8 | 5-8.5 | .132-.255 | 3.35-6.48 | White/Red | M22520/23-01 | M22520/23-02 |
| 4 | 6-4 | 13-21 | .237-.370 | 6.01-9.40 | White/Blue | M22520/23-01 | M22520/23-04 |
| 0 | 2-0 | 34-60 | .360-.550 | 9.14-13.97 | White/Yell. | M22520/23-01 | M22520/23-05 |

INSERTION/REMOVAL TOOLS

| Contact Size | Color Code | Military Part Number | Amphenol/Matrix Part Number |
|--------------|--------------|----------------------|-----------------------------|
| 16 | Blue/White | M81969/14-03 | 10-538988-016 |
| 12 | Yellow/White | M81969/14-04 | 10-538988-012 |
| 8 | Red | M81969/14-06 | 6500-018-0008 |
| 4 | Blue | M81969/14-07 | 6500-018-0004 |
| 0 | Yellow | M81969/14-08 | 6500-018-0000 |

Amphenol installation instructions, L-2106, gives information on insertion, removal and crimping of contacts for Matrix MIL-DTL-5015 connectors.

BACKSHELLS

The section of this catalog called "Backshells" covers the backshells for MIL-DTL-5015 that are provided through Amphenol PCD. Please refer to this section for:
• Backshells for Connector Family "J", which includes MIL-DTL-26482 (Series II), MIL-DTL-5015 (MS3400), MIL-DTL-83723 (Series I & III).

PLUG PROTECTION CAP 10-329393-XX*

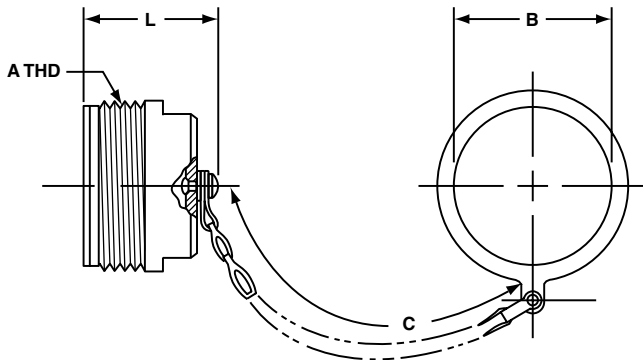

| Assembly Number | A Thread Class 2A | B Dia. +.010 - .000 | C Approx. | L Max. |
|-----------------|-------------------|---------------------|-----------|--------|
| 10-329393-10 | .625-24UNEF | .641 | 3.5 | 1.312 |
| 10-329393-11 | .625-24UNEF | .641 | 3.5 | 1.312 |
| 10-329393-12 | .750-20UNEF | .766 | 3.5 | 1.500 |
| 10-329393-14 | .875-20UNEF | .891 | 3.5 | 1.500 |
| 10-329393-16 | 1.000-20UNEF | 1.016 | 3.5 | 1.500 |
| 10-329393-18 | 1.125-18UNEF | 1.141 | 3.5 | 1.500 |
| 10-329393-20 | 1.250-18UNEF | 1.266 | 4.0 | 1.500 |
| 10-329393-22 | 1.375-18UNEF | 1.391 | 4.0 | 1.500 |
| 10-329393-24 | 1.500-18UNEF | 1.641 | 4.5 | 1.500 |
| 10-329393-28 | 1.750-18UNS | 1.891 | 4.5 | 1.500 |
| 10-329393-32 | 2.000-18UNS | 2.078 | 5.0 | 1.500 |
| 10-329393-36 | 2.250-16UN | 2.328 | 5.0 | 1.500 |
| 10-329393-40 | 2.500-16UN | 2.641 | 5.0 | 1.500 |
| 10-329393-44 | 2.750-16UN | 2.891 | 6.0 | 1.500 |

PLUG PROTECTION CAP 10-229125-XX*

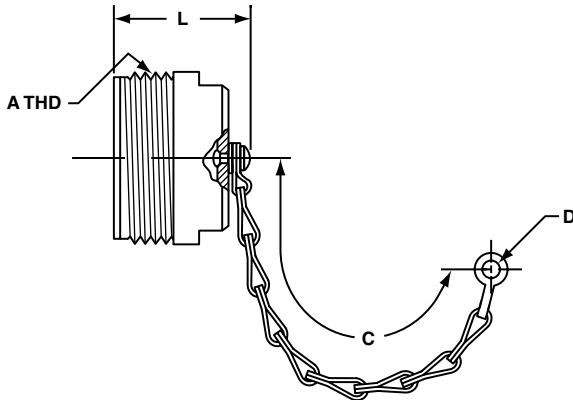

| Assembly Number | A Thread Class 2A | C Approx. | D Ref. | L Max. |
|-----------------|-------------------|-----------|--------|--------|
| 10-229125-10 | .625-24NEF | 3.0 | .140 | 1.233 |
| 10-229125-12 | .750-20UNEF | 3.5 | .140 | 1.421 |
| 10-229125-14 | .875-20UNEF | 3.5 | .140 | 1.421 |
| 10-229125-16 | 1.000-20UNEF | 3.5 | .140 | 1.421 |
| 10-229125-18 | 1.125-18NEF | 3.5 | .140 | 1.421 |
| 10-229125-20 | 1.250-18NEF | 3.5 | .193 | 1.421 |
| 10-229125-22 | 1.375-18NEF | 3.5 | .193 | 1.421 |
| 10-229125-24 | 1.500-18NEF | 4.5 | .193 | 1.421 |
| 10-229125-28 | 1.750-18NS | 4.5 | .193 | 1.421 |
| 10-229125-32 | 2.000-18NS | 5.0 | .193 | 1.421 |
| 10-229125-36 | 2.250-16UN | 5.0 | .193 | 1.421 |
| 10-229125-40 | 2.500-16UN | 5.0 | .193 | 1.421 |

PLUG PROTECTION CAP MS25042-XXDA*

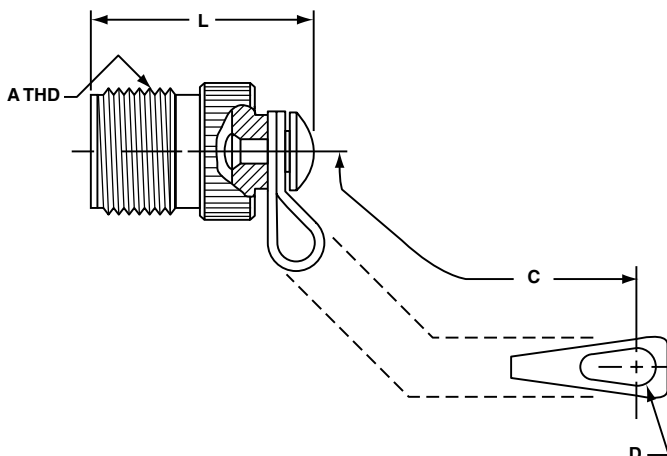

| MS Number | A Thread Class 2A | B Dia. +.010 - .005 | C Approx. | L Max. |
|--------------|-------------------|---------------------|-----------|--------|
| MS25042-8DA | .500-28UNEF | .156 | 4.00 | .969 |
| MS25042-10DA | .625-24UNEF | .156 | 4.00 | .969 |
| MS25042-12DA | .750-20UNEF | .156 | 4.50 | 1.156 |
| MS25042-14DA | .875-20UNEF | .156 | 4.50 | 1.156 |
| MS25042-16DA | 1.000-20UNEF | .156 | 4.50 | 1.156 |
| MS25042-18DA | 1.125-18UNEF | .156 | 4.50 | 1.156 |
| MS25042-20DA | 1.250-18UNEF | .187 | 5.00 | 1.156 |
| MS25042-22DA | 1.375-18UNEF | .187 | 5.00 | 1.156 |
| MS25042-24DA | 1.500-18UNEF | .187 | 5.50 | 1.156 |
| MS25042-28DA | 1.750-18UNS | .187 | 7.75 | 1.156 |
| MS25042-32DA | 2.000-18UNS | .218 | 7.75 | 1.156 |
| MS25042-36DA | 2.250-16UN | .218 | 7.75 | 1.156 |
| MS25042-40DA | 2.500-16UN | .218 | 7.75 | 1.156 |

* Protective caps are illustrated with sash chains and are available with beaded chains or without chains. Optional terminations are also available. Consult Amphenol Aerospace when ordering.

38999

- III
- HD
- Dualok
- II
- I
- SJT
- Accessories
- Aquacon
- Herm/Seal
- PCB

- HIGH SPEED
- Fiber Optics
- Contacts
- Connectors
- Cables

- EMI Filter
- Transient
- 26482
- Matrix 2
- 83723
- III
- Matrix | Pyle
- 26500
- Pyle

- 5015
- Crimp Rear
- Release
- Matrix
- 22992
- Class 1
- Back-
- Shells
- Options
- Others

38999

- III
- HD
- Dualok
- II
- I
- SJT
- Accessories
- Aquacon
- Herm/Seal
- PCB

HIGH SPEED

- Fiber Optics
- Contacts
- Connectors
- Cables

EMI Filter Transient

26482 Matrix 2

83723 III Matrix | Pyle

26500 Pyle

5015 Crimp Rear Release Matrix

22992 Class I

Back-Shells

Options Others

| Assembly Number | A Thread Class 2B | B Dia. Min. | C Approx. | D Dia. Max. | L Max. |
|-----------------|-------------------|-------------|-----------|-------------|--------|
| 10-329394-10 | .625-24UNEF | .641 | 3.5 | .875 | .793 |
| 10-329394-12 | .750-20UNEF | .766 | 3.5 | 1.000 | .793 |
| 10-329394-14 | .875-20UNEF | .891 | 3.5 | 1.125 | .793 |
| 10-329394-16 | 1.000-20UNEF | 1.016 | 3.5 | 1.250 | .793 |
| 10-329394-18 | 1.125-18UNEF | 1.141 | 3.5 | 1.375 | 1.024 |
| 10-329394-20 | 1.250-18UNEF | 1.266 | 4.0 | 1.500 | 1.024 |
| 10-329394-22 | 1.375-18UNEF | 1.391 | 4.0 | 1.625 | 1.024 |
| 10-329394-24 | 1.500-18UNEF | 1.641 | 4.5 | 1.750 | 1.024 |
| 10-329394-28 | 1.750-18UNS | 1.891 | 4.5 | 2.000 | 1.024 |
| 10-329394-32 | 2.000-18UNS | 2.078 | 5.0 | 2.250 | 1.024 |
| 10-329394-36 | 2.250-16UN | 2.328 | 5.0 | 2.500 | 1.024 |
| 10-329394-40 | 2.500-16UN | 2.641 | 5.0 | 2.656 | 1.024 |
| 10-329394-44 | 2.750-16UN | 2.891 | 6.0 | 2.938 | 1.024 |

| Assembly Number | A Thread Class 2B | B Ref. | C Approx. | D Dia. Max. | L Max. |
|-----------------|-------------------|--------|-----------|-------------|--------|
| 10-422905-103 | .625-24UNEF | .140 | 3.0 | .875 | .812 |
| 10-422905-123 | .750-20UNEF | .140 | 3.5 | 1.000 | .812 |
| 10-422905-143 | .875-20UNEF | .140 | 3.5 | 1.125 | .812 |
| 10-422905-163 | 1.000-20UNEF | .140 | 3.5 | 1.250 | .812 |
| 10-422905-183 | 1.125-18UNEF | .193 | 3.5 | 1.375 | 1.031 |
| 10-422905-203 | 1.250-18UNEF | .193 | 4.0 | 1.500 | 1.031 |
| 10-422905-223 | 1.375-18UNEF | .193 | 4.0 | 1.625 | 1.031 |
| 10-422905-243 | 1.500-18UNEF | .193 | 4.5 | 1.750 | 1.031 |
| 10-422905-283 | 1.750-18UNS | .193 | 4.5 | 2.000 | 1.031 |
| 10-422905-323 | 2.000-18UNS | .193 | 5.0 | 2.250 | 1.031 |
| 10-422905-363 | 2.250-16UN | .193 | 5.0 | 2.500 | 1.031 |
| 10-422905-403 | 2.500-16UN | .193 | 5.0 | 2.656 | 1.031 |

| MS Number | A Thread Class 2B | B +.010 - .005 | C Approx. | D Dia. Max. | L Max. |
|--------------|-------------------|----------------|-----------|-------------|--------|
| MS25043-8DA | .500-28UNEF | .140 | 4.00 | .688 | .750 |
| MS25043-10DA | .625-24UNEF | .140 | 4.00 | .815 | .750 |
| MS25043-12DA | .750-20UNEF | .140 | 4.50 | 1.000 | .750 |
| MS25043-14DA | .875-20UNEF | .140 | 4.50 | 1.125 | .750 |
| MS25043-16DA | 1.000-20UNEF | .140 | 4.50 | 1.188 | .750 |
| MS25043-18DA | 1.125-18UNEF | .140 | 4.50 | 1.344 | .750 |
| MS25043-20DA | 1.250-18UNEF | .140 | 5.00 | 1.469 | .750 |
| MS25043-22DA | 1.375-18UNEF | .140 | 5.00 | 1.594 | .750 |
| MS25043-24DA | 1.500-18UNEF | .171 | 5.50 | 1.719 | .750 |
| MS25043-28DA | 1.750-18UNS | .171 | 7.75 | 1.969 | .812 |
| MS25043-32DA | 2.000-18UNS | .187 | 7.75 | 2.219 | .812 |
| MS25043-36DA | 2.250-16UN | .187 | 7.75 | 2.469 | .812 |
| MS25043-40DA | 2.500-16UN | .187 | 7.75 | 2.719 | .812 |

RECEPTACLE PROTECTION CAP 10-329394-XX*

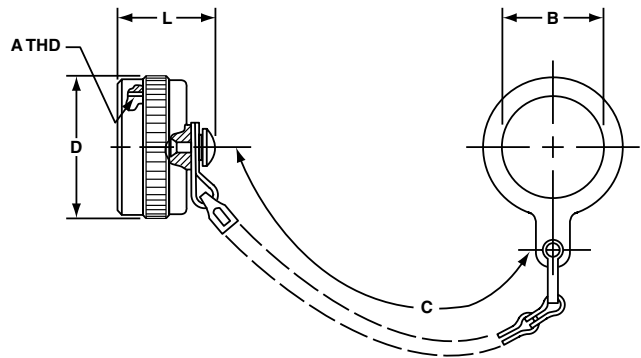

RECEPTACLE PROTECTION CAP 10-422905-XXX*

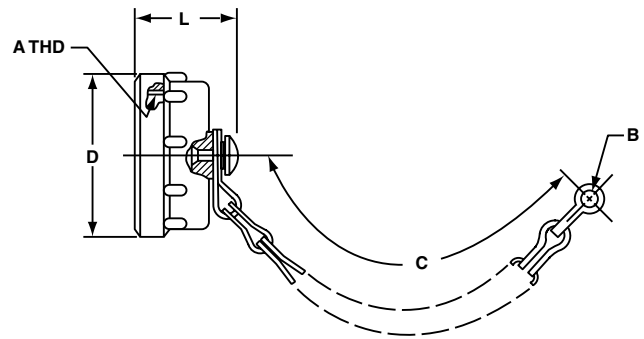

RECEPTACLE PROTECTION CAP MS25043-XXDA*

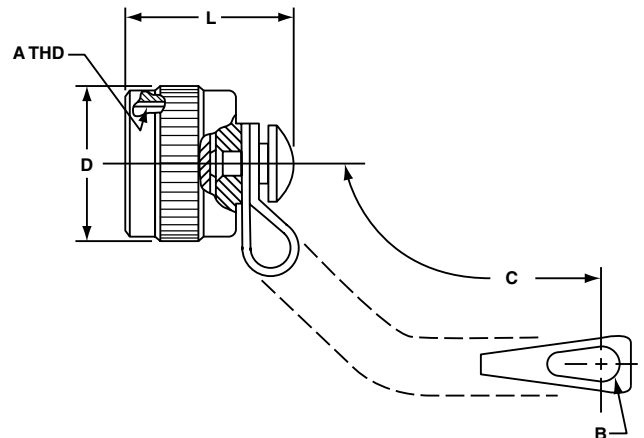

* Protective caps are illustrated with sash chains and are available with beaded chains or without chains. Optional terminations are also available. Consult Amphenol Aerospace when ordering.

10-70500 RECEPTACLE DUST CAP for external threads

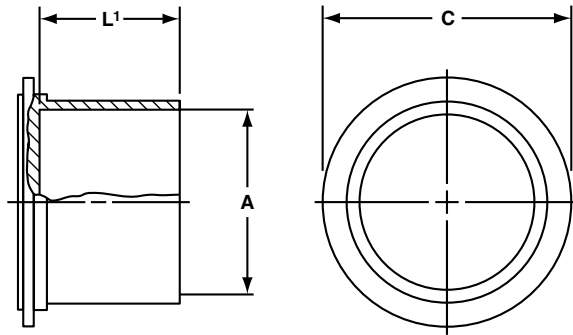

| MS Shell Size | Order Number | A Dia. Nominal Thread | C Dia. ±.031 | L ¹ ±.062 |
|---------------|--------------|-----------------------|--------------|----------------------|
| 8S | 10-70500-8 | .500 | .750 | .500 |
| 10S | 10-70500-10 | .625 | .875 | .500 |
| 10SL | 10-70500-10 | .625 | .875 | .500 |
| 12S | 10-70500-12 | .750 | 1.000 | .500 |
| 12 | 10-70500-12 | .750 | 1.000 | .500 |
| 14S | 10-70500-14 | .875 | 1.125 | .500 |
| 14 | 10-70500-14 | .875 | 1.125 | .500 |
| 16S | 10-70500-16 | 1.000 | 1.250 | .500 |
| 16 | 10-70500-16 | 1.000 | 1.250 | .500 |
| 18 | 10-70500-18 | 1.125 | 1.375 | .562 |
| 20 | 10-70500-20 | 1.250 | 1.500 | .562 |
| 22 | 10-70500-22 | 1.375 | 1.625 | .562 |
| 24 | 10-70500-24 | 1.500 | 1.750 | .562 |
| 28 | 10-70500-28 | 1.750 | 1.938 | .562 |
| 32 | 10-70500-32 | 2.000 | 2.250 | .562 |
| 36 | 10-70500-36 | 2.250 | 2.500 | .625 |
| 40 | 10-70500-40 | 2.500 | 2.750 | .625 |

10-70506 PLUG DUST CAP for internal threads

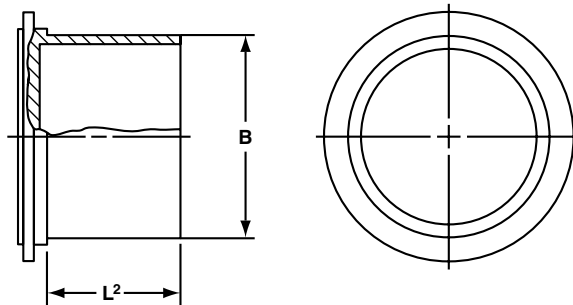

| MS Shell Size | Order Number | B Dia. Min. | L ² ±.125 |
|---------------|--------------|-------------|----------------------|
| 8S | 10-70506-8S | .469 | .625 |
| 10S | 10-70506-10S | .587 | .625 |
| 10SL | 10-70506-10S | .587 | .625 |
| 12S | 10-70506-12 | .704 | .625 |
| 12 | 10-70506-12 | .704 | .625 |
| 14S | 10-70506-14 | .828 | .625 |
| 14 | 10-70506-14 | .828 | .625 |
| 16S | 10-70506-16 | .953 | .625 |
| 16 | 10-70506-16 | .953 | .625 |
| 18 | 10-70506-18 | 1.072 | .625 |
| 20 | 10-70506-20 | 1.197 | .625 |
| 22 | 10-70506-22 | 1.322 | .625 |
| 24 | 10-70506-24 | 1.447 | .625 |
| 28 | 10-70506-28 | 1.697 | .625 |
| 32 | 10-70506-32 | 1.947 | .625 |
| 36 | 10-70506-36 | 2.190 | .625 |
| 40 | 10-70506-40 | 2.440 | .625 |

38999

III
HD
Dualok
II
I
SJT
Accessories
Aquacon
Herm/Seal
PCB

HIGH SPEED
Fiber Optics
Contacts
Connectors
Cables

EMI Filter
Transient

26482
Matrix 2

83723 III
Matrix | Pyle

26500
Pyle

5015
Crimp Rear
Release
Matrix

22992
Class 1

Back-
Shells

Options
Others

38999

- III
- HD
- Dualok
- II
- I
- SJT
- Accessories
- Aquacon
- Herm/Seal
- PCB

- HIGH SPEED**
- Fiber Optics
- Contacts
- Connectors
- Cables

- EMI Filter
- Transient

- 26482
- Matrix 2

- 83723 III
- Matrix | Pyle

- 26500
- Pyle

- 5015
- Crimp Rear Release Matrix

- 22992
- Class 1

- Back-Shells

- Options
- Others



MS/Standard 3100 Series, MIL-5015 Type Connectors

MIL-DTL-5015 and MIL-5015 Type Standard Circular Connectors with solder or crimp (non-rear release) contacts

Amphenol has long been the accepted leader in providing MS Standard MIL-5015 type connectors. These connectors represent well-proven electrical capability at an economical cost for most equipment where durability is important.

The MS/Standard family of connectors (3100 Series) is a very broad range of product with the following features:

- Medium to heavy weight cylindrical with resilient inserts
- Environmental resistant
- Threaded couplings, single key/keyway shell polarization
- Operating voltage to 3000 VAC (RMS) at sea level
- 5 shell styles, 19 shell sizes, 280 contact arrangements
- Solder or crimp contacts (non-rear-release type), sizes 16–0 accepting 22–0 AWG
- Coaxial or thermocouple contact options
- Alternate insert positioning
- Hermetic configurations available
- Zinc alloy plating (cadmium-free) available

The 3100 Series has five classes of connectors to meet different requirements. Within these connector styles, MIL-C-5015 has been replaced as follows: Environmental classes F and R are updated to and produced in strict accordance to MIL-DTL-5015. Classes A, C and E are still produced, but are no longer listed on the qualified products listing (QPL). Class designations and brief descriptions are as follows:

- A – Solid Shell – for general, non-environmental applications.
- C – Pressurized – for use on pressurized bulkheads or pressure barriers; limits air leakage regardless of type and class of plug mated with them.
- E/F – Environmental Resisting with Strain Relief – designed for applications where the connector will be exposed to moisture, vibration, and rapid changes in pressure and temperature.
- R – Lightweight Environmental Resisting – shorter in length, lighter in weight than the E & F classes, the MS-R offers a high degree of reliability under adverse conditions: recommended for new design applications.

Ask for Amphenol catalog 12-020 which gives detailed information on this family of connectors or visit www.amphenol-industrial.com

MIL-5015 Modifications

In order to supplement standard MS shell styles and provide a greater variety of styles for the electrical connector user, there are several MS and MS Modified cylindrical connectors offered by Amphenol. These types include flange mount plugs, thru bulkhead receptacles, jam nut receptacles, connectors for potting and connectors designed specifically to terminate jacketed cable. Ask for Amphenol catalog 12-021 for detailed information or visit www.amphenol-industrial.com.

97 Series, MIL-5015 Type Connectors

The low cost, general duty connector used extensively in the machine tool industry, welding industry and numerous other industrial applications, is the Amphenol® 97 Series. Offered in non-environmental styles, these connectors have hard dielectric inserts and threaded coupling. They are Underwriters Laboratories Recognized and Canadian Standards Association Certified.

Recent addition to this family is the 97E environmental styles, still an economical choice. The 97E can be used in a variety of industrial applications where environmental sealing is required, such as automotive and robotics.

Ask for Amphenol catalog 12-022 for detailed information or visit www.amphenol-industrial.com.



97 Series, MIL-5015 Type Connectors

X-ON Electronics

Largest Supplier of Electrical and Electronic Components

Click to view similar products for [Circular MIL Spec Tools, Hardware & Accessories](#) *category:*

Click to view products by [Amphenol](#) *manufacturer:*

Other Similar products are found below :

[0113-201-2025](#) [600-079-06](#) [600-146-06](#) [M10-101982-143](#) [M10-101982-163](#) [M10-101983-183](#) [M10-150912-083](#) [M10-454396-008](#)
[602GB18808](#) [CS3102A-22-14PW](#) [M2887615-CD](#) [627-009](#) [M38999/9-19B](#) [630A007NF083A](#) [630B007M051A](#) [630BJ003NF032H](#) [637-](#)
[149NF04B](#) [M39029/29-215](#) [6408-203V-09273](#) [6426-201-11343](#) [650FS002NF16](#) [660-008NF14S7-01](#) [660-009M22H8-03](#) [660-013NF19U6-](#)
[210](#) [660-015M10S6-17](#) [660-015NF10S5-01](#) [660-015NF14R3.5-01](#) [660-023NF19H6-19](#) [660-024NF11S12-01](#) [660-024NF11S3-01](#) [660-](#)
[024NF17S4-109](#) [660-050XM17F4-01](#) [660-068NF25R6-30G](#) [660-070M23S8-04](#) [660-073MTCH9-20](#) [M83723/61-18W](#) [M83723/61-218R](#)
[M83723/61-224W](#) [667-084-23C](#) [667-084-35C](#) [667-224NF16](#) [687-697NF-1](#) [M85049/94-10-A](#) [M85049/96-7-A](#) [M855282-10A01A](#)
[M85528/2-10B](#) [M855282-18A01A](#) [M85528/2-22A01A](#) [M85528/2-22AA](#) [710HS460NF2508](#)