

7	8
REV.	DESCRIPTION

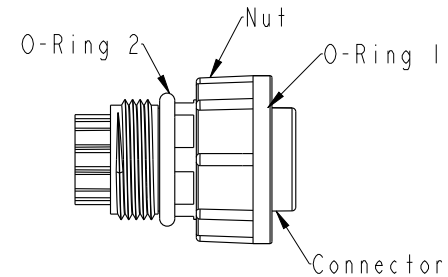
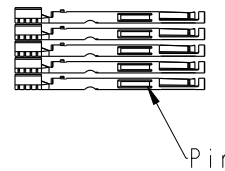
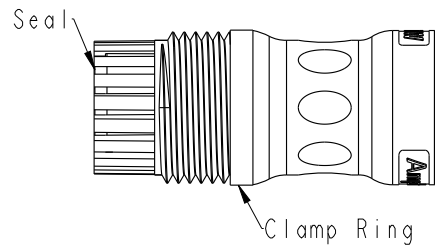
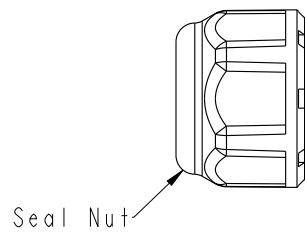

Material Specification:

- * Connector: Nylon+GF, Black.
- * Pins: Copper Alloy, Gold Plated.
- * Seal & O-Ring: Silicone, Gray.
- * UL Rated: UL 94V-0, fl.
- * RoHS Compliant.

Electrical Specification:

- * Contact Resistance: 10mΩ Max.
- * Insulation Resistance: 100MΩ Min.
- * Dielectric Withstand Voltage: 1,600 Vac.

Mechanical Specification:

- * Durability: 1000 Cycles.
- * Tensile strength: 10 kgf.
- * Wire Conductor:
 - 5A: 22AWG~20AWG
 - 10A: 18AWG~16AWG
 - 20A: 14AWG~12AWG
- * Wire Insulation OD:
 - 5A: 1.9mm Max.
 - 10A: 2.7mm Max.
 - 20A: 4.3mm Max.
- * Torque Force for Clamp Ring: 6~8 kgf-cm
- * Torque Force for Seal Nut: 6~8 kgf-cm

Environmental Specification:

- * Waterproof Rating: IP67(Mated)
- * Temperature Range: -40°C to 105°C.
- * Salt Spray: Mated, 1000 Hours.
- * Safety Compliance: UL 1977.

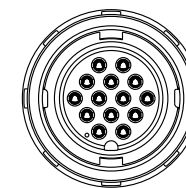
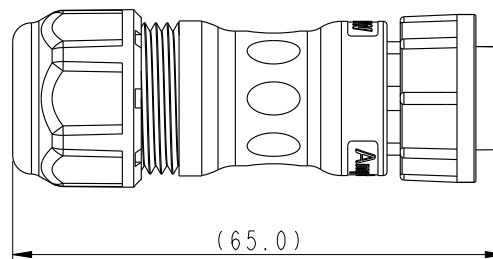
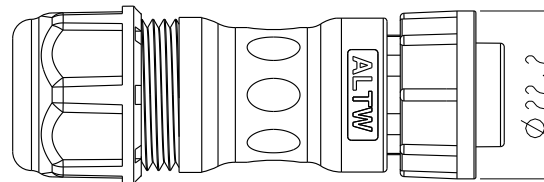

UNIT:mm			TITLE Circular C-Size Field Installable Cable Type F Conn		
TOLERANCE ±0.5 mm			SCALE 8:5	SIZE A4	SHEET 1 OF 2
REV. A	WC-REV. A.3	QC: Inspection item			

Amphenol LTW
安費諾亮泰企業股份有限公司

ITEM NO	DRAWN BY Peng	DATE 2018-12-15
DWG NO ACX-XXBFXC-LL7XXX	CHECKED BY Mafei	DATE 2018-12-15
CUSTOMER ALTW	APPROVED BY Jerry	DATE 2018-12-15

THIS DOCUMENT IS SUBJECT TO CHANGE WITHOUT NOTICE. IT IS CONFIDENTIAL AND A PROPERTY OF Amphenol LTW. DISCLOSURE TO THIRD PARTY HAS TO BE AUTHORIZED BY Amphenol LTW.

THIS DOCUMENT IS SUBJECT TO CHANGE WITHOUT NOTICE. IT IS CONFIDENTIAL AND A PROPERTY OF Amphenol LTW. DISCLOSURE TO THIRD PARTY HAS TO BE AUTHORIZED BY Amphenol LTW.

Ordering Information:

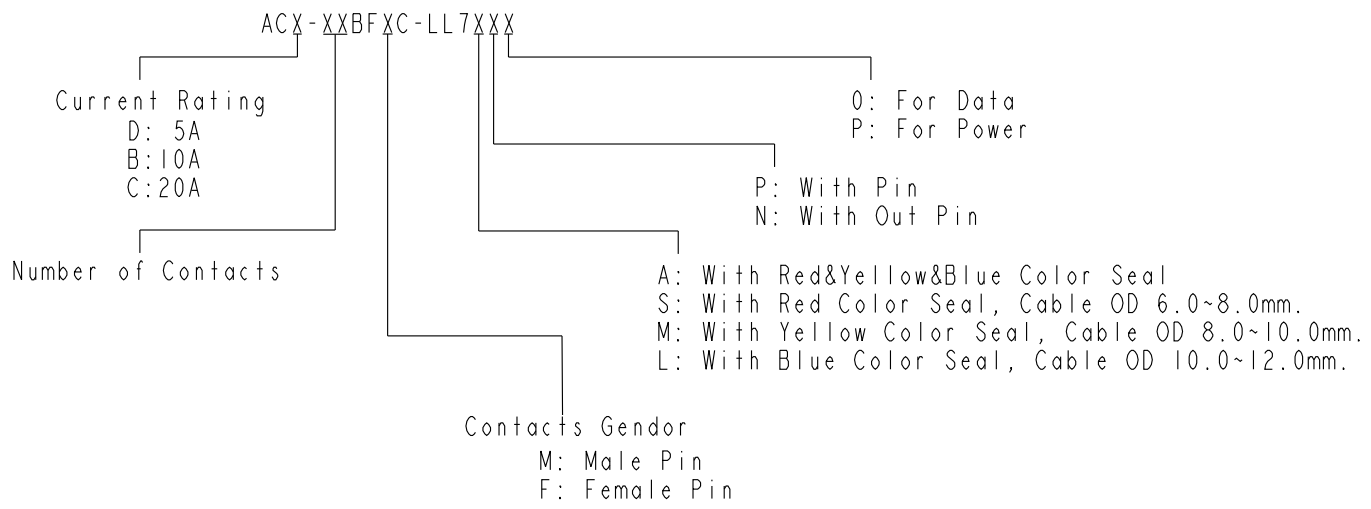

Pin Assignments Front View	20A ; 2 Contacts(02)	10A ; 4 Contacts(04)	10A ; 5 Contacts(05)	10A ; 6 Contacts(06)	5A ; 7 Contacts(07)	5A ; 8 Contacts(08)	5A ; 9 Contacts(09)	5A ; 10 Contacts(10)	5A ; 12 Contacts(12)	5A ; 14 Contacts(14)
Male Pin										
Female Pin										

UNIT:mm		TITLE Circular C-Size Field Installable Cable Type F Conn		
TOLERANCE ±0.5 mm		SCALE 8:5	SIZE A4	SHEET 2 OF 2
		REV. A	WC-REV. A.3	QC: Inspection item

Amphenol LTW
 安費諾亮泰企業股份有限公司

ITEM NO	DRAWN BY Peng	DATE 2018-12-15
DWG NO ACX-XXBFXC-LL7XXX	CHECKED BY Mafei	DATE 2018-12-15
CUSTOMER ALTW	APPROVED BY Jerry	DATE 2018-12-15

X-ON Electronics

Largest Supplier of Electrical and Electronic Components

Click to view similar products for [Circular Metric Connectors](#) category:

Click to view products by [Amphenol](#) manufacturer:

Other Similar products are found below :

[600X518037X](#) [6STD15PCR99B70A](#) [8R4000A16M020](#) [8R5000A16M005](#) [1200910002](#) [1203580030](#) [1200910008](#) [1200910011](#) [1300140094](#)
[130203-0054](#) [1300140026](#) [1300150099](#) [1-3637-600-5205](#) [1612618](#) [21036836414](#) [8R4006A16M010](#) [1R3006A20M005](#) [41-40011](#) [42-00006](#)
[42-01015](#) [4-22279-4](#) [4-22281-1](#) [4-22284-9](#) [43-00113](#) [43-01203](#) [41-40013](#) [42-00008](#) [43-00343](#) [43-01026](#) [43-01162](#) [43-01173](#) [43-10000](#)
[XS3P-M421-2](#) [600X518050X](#) [8R5006A16M020](#) [8R5006A16M005](#) [8R4000A16M010](#) [6-22279-3](#) [1605332](#) [N03FA03144](#) [1300140077](#) [43-](#)
[16213](#) [43-01338](#) [XS2RD4265](#) [XS2R-D426-1](#) [XS8A-0441](#) [859RD04-103R004](#) [860RD04-113R004](#) [860RD04-213R004](#) [1-213245-2](#)