

**TABLE OF PART NUMBERS**

CONNECTOR  
END A

ADAPTOR ASSY PART No.

CONNECTOR  
END B



AC3FDZB

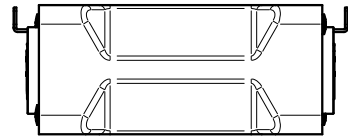

AC3F3FDW



AC3FDZB



AC3FDZB

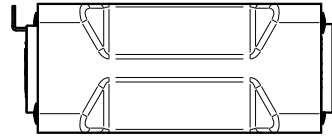

AC3F3MDW



AC3MDZB

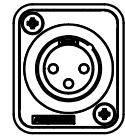

AC3MDZB

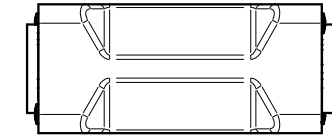

AC3M3MDW



AC3MDZB



AC5FDZB

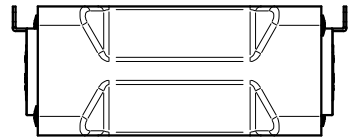

AC5F5FDW



AC5FDZB



AC5FDZB

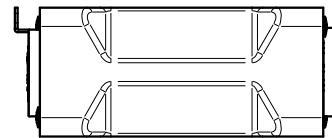

AC5F5MDW



AC5MDZB

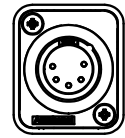

AC5MDZB

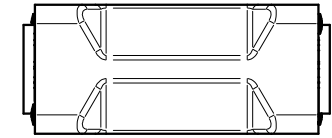

AC5M5MDW



AC5MDZB



SP-2-MD

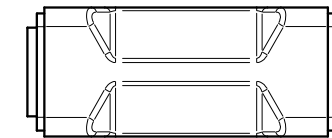

SP2F2FDW



SP-2-MD

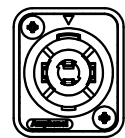

SP-4-MD

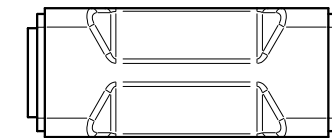

SP4F4FDW

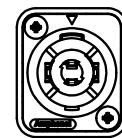

SP-4-MD



AC-BNC-JS-75B

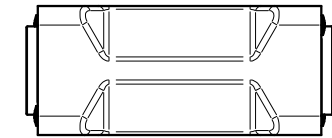

ACBNCJJDW



AC-BNC-JS-75B

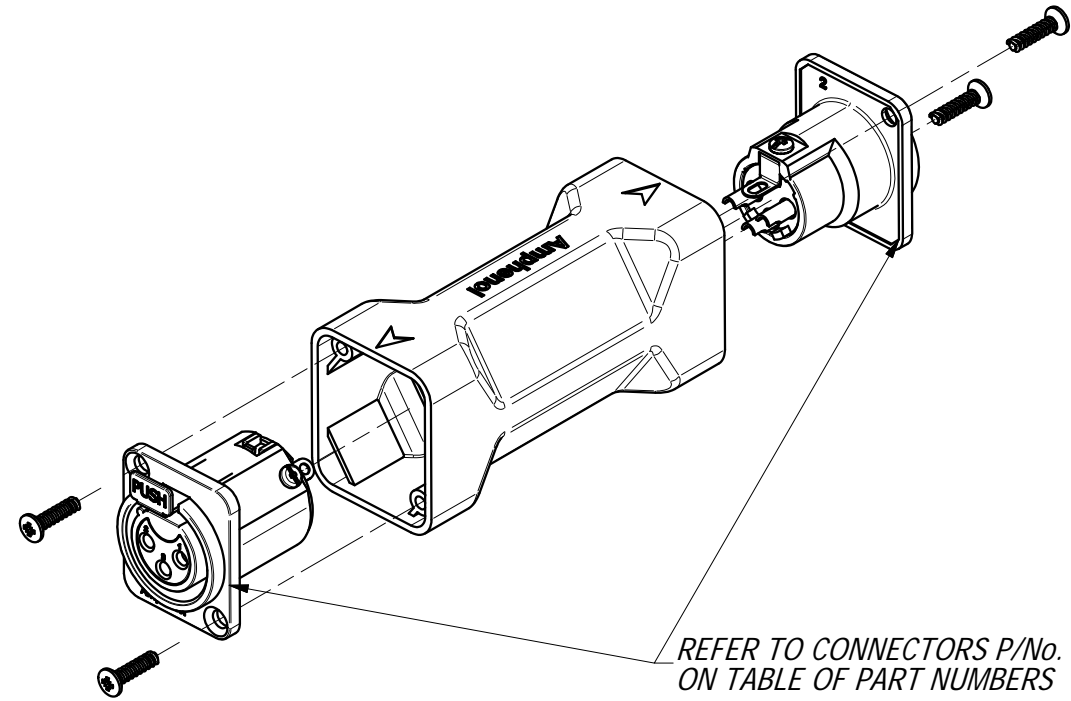

REFER TO CONNECTORS P/No.  
ON TABLE OF PART NUMBERS

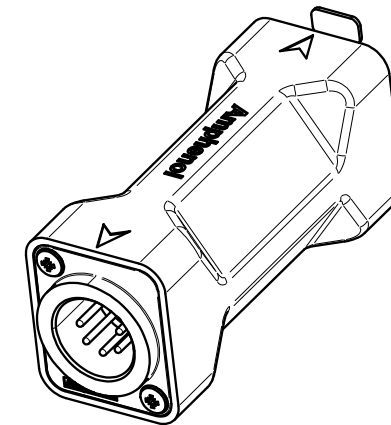
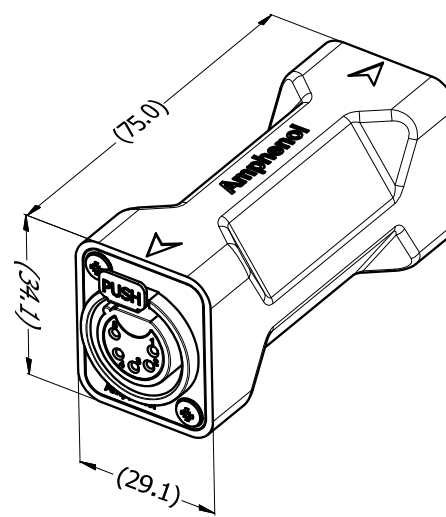

UNLESS OTHERWISE SPECIFIED TOLERANCE TO BE		THIS DOCUMENT IS THE PROPERTY OF AMPHENOL AUSTRALIA PTY. LTD. NO PART THEREOF MAY BE REPRODUCED AND USED WITHOUT THE PRIOR WRITTEN CONSENT OF THE OWNER.				<b>Amphenol</b> Amphenol Australia Pty.Ltd, 22 Industry Blvd, Carrum Downs VIC 3201	
LINER	ANGULAR	MATERIAL:	DRN: T.N	DATE: 15/05/14	TITLE:	PART No:	REV
X ± 0.5	X' ± 1	REFER TO COMPONENTS	CKD: T.Z	DATE: 15/05/14	<b>ADAPTOR XLR-SP-BNC-HP CUSTOMER DWG</b>	<b>REFER TABLE</b>	<b>1</b>
X.X ± 0.1	X.X' ± 30'		APP'D: P.M	DATE: 24/06/14			
X.X ± 0.05	X.X'X' ± 15'	DO NOT SCALE	SCALE: <b>NTS</b>	SIZE: <b>A3</b>	DRAWING No.	55011005-000-1	SHEET
DIMENSIONS IN MILLIMETRES		THIRD ANGLE PROJECTION		CB4.17.F1			

## X-ON Electronics

Largest Supplier of Electrical and Electronic Components

*Click to view similar products for [XLR Connectors](#) category:*

*Click to view products by [Amphenol](#) manufacturer:*

Other Similar products are found below :

[707-0300](#) [PPCB-H](#) [A3F01](#) [A3M01](#) [QGP3F](#) [HA16PRQ-3SE\(71\)](#) [AA3FL](#) [AAA4FWZ](#) [AAA4MWZ](#) [AC3-MIC](#) [AC4-MIC](#) [AC5FPZB](#)  
[AC6AFDZV](#) [D4FB](#) [DE4MW](#) [DHNF-BAG](#) [E3MBAUSW](#) [NA2FP-UW](#) [NA3MP-UW](#) [NC3FBHR1-0](#) [NC3FD-H-0](#) [NC3FK-V](#) [NC3FXY-B](#)  
[NC3MK-V](#) [NC3MXY](#) [NC5FX-HD-B](#) [NC6MSX-BAG](#) [91210071096](#) [SL05](#) [99.265.0400.0](#) [A3F04](#) [AC3FG](#) [AC4-FCP](#) [AC4FPZ](#) [AQG4F](#)  
[2504FP](#) [30-498-2](#) [R6MZ](#) [3FD-H-I](#) [3FD-H-I-\(0\)](#) [3FD-H-I-B](#) [3FD-V-I](#) [3FD-V-I-\(0\)](#) [3FD-V-I-B](#) [3MD-H-I-B](#) [3MD-V-I](#) [3MD-V-I-B](#) [TA01](#)  
[TA3MWX](#) [TA5MLWX](#)