

FIBRE WASHER

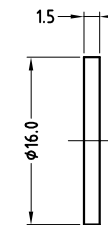

NUT OPTIONS

PLASTIC NUT

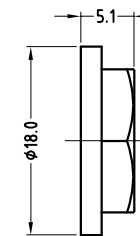

METAL NUT

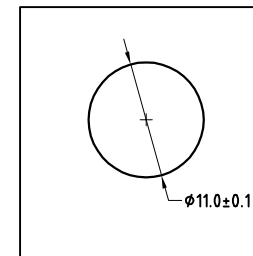
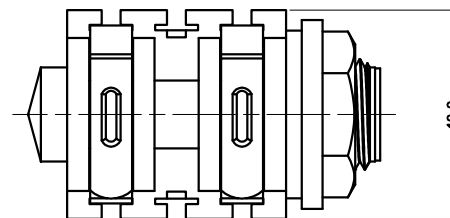
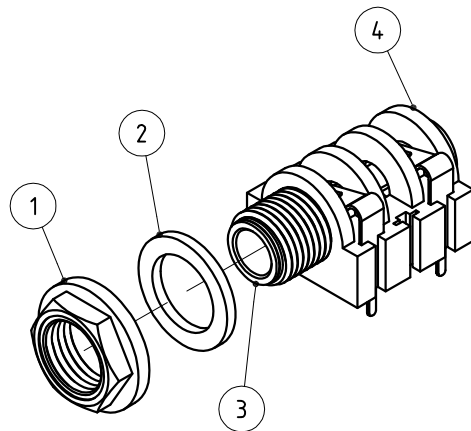
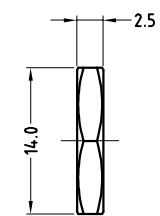

PANEL CUTOUT

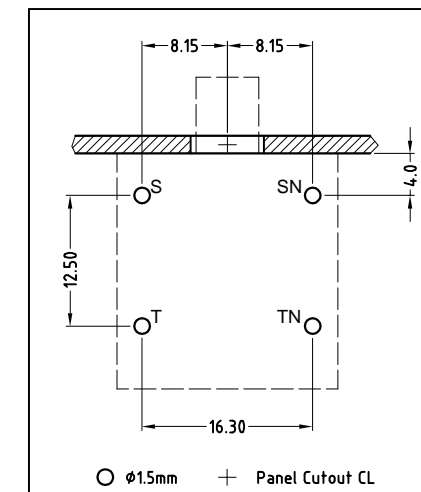

PCB LAYOUT

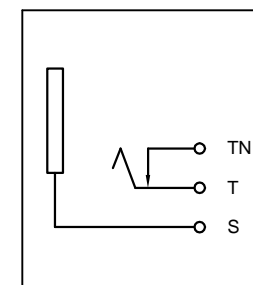

SCHEMATIC

ITEM	DESCRIPTION
1	METAL/PLASTIC NUT
2	FIBRE WASHER
3	METAL TUBE INSERT
4	CONNECTOR ASSEMBLY

PART No.	CATALOG No.	DESCRIPTION
55010097-000	ACJM-MH	METAL NUT
55010097-001	ACJM-PH	PLASTIC NUT

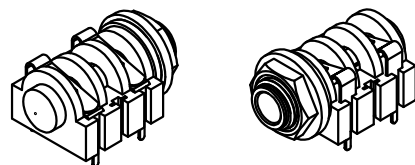

ISO VIEW

UNLESS OTHERWISE SPECIFIED TOLERANCE TO BE		THIS DOCUMENT IS THE PROPERTY OF AMPHENOL AUSTRALIA PTY. LTD. NO PART THEREOF MAY BE REPRODUCED AND USED WITHOUT THE PRIOR WRITTEN CONSENT OF THE OWNER			
LINEAR	ANGULAR	CAD FILE:	DRN:	DATE:	REV.
X ± 0.5	X° ± 1°	55010097000111	L.V	17-10-01	1
X.X ± 0.1	X°X' ± 30'	MATL: REFER TO COMPONENT	CKD: M.N.H	DATE: 13-01-06	0
X.XX ± 0.05	X°X'X" ± 15'	FINISH: REFER TO COMPONENT	APP'D: P.M	DATE: 13-01-06	REV.
DO NOT SCALE		THIRD ANGLE PROJECTION		SCALE: 2:1 UOS	PART No: REFER TO TABLE

1	CHANGE DRAWING NUMBER & PART VARIATION NUMBER	L.V	07-07-04	8293
0	FIRST ISSUE	L.V	17-10-01	----
TITLE: 1/4" MONO JACK PCB LUG CUSTOMER DRAWING		BY	DATE	CHG/No
DRAWING NO. 55010097-000-1		SHEET 1 OF 1		

Amphenol
Amphenol Australia Pty Ltd, 2 Fineways Blvd, Keysborough, Vic 3173

X-ON Electronics

Largest Supplier of Electrical and Electronic Components

Click to view similar products for [Phone Connectors](#) category:

Click to view products by [Amphenol](#) manufacturer:

Other Similar products are found below :

[M444B](#) [6J1041A](#) [R4F](#) [E12BPKG](#) [ECP4PKG](#) [161-3502L-E](#) [MT333X](#) [171-0350-EX](#) [171-101A-EX](#) [171-3325-EX](#) [176S](#) [NC3MG-V](#)
[NYS228G](#) [P10834](#) [P2380](#) [P2381X](#) [P2411X](#) [P2412](#) [P2724](#) [JM2PB-AU BULK](#) [9144](#) [S2674](#) [280L](#) [163-156N-2-E](#) [163-158N-2-E](#) [171-3308-](#)
[EX](#) [171-3500-E](#) [2501FT](#) [CMT335](#) [M10662](#) [330Q](#) [RJ5VI-S](#) [40116](#) [TM1R-AU](#) [TM2PBMJ-AU](#) [TM2PJ-AU](#) [TM2PJ-AU BULK](#) [4803.1351](#)
[49201](#) [49205](#) [TS3PBJ-AU](#) [TS3PBMJ-AU](#) [TT32BX](#) [54B](#) [40112](#) [40205](#) [XMT332B](#) [52170017-331](#) [570](#) [NM3](#)