

FIBRE WASHER

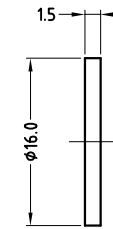

**NUT OPTIONS**

PLASTIC NUT

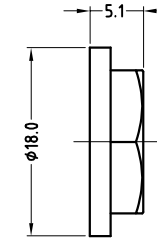

METAL NUT

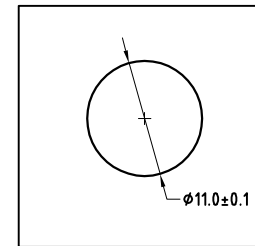
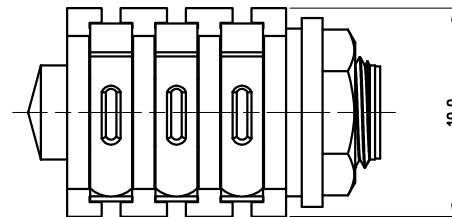
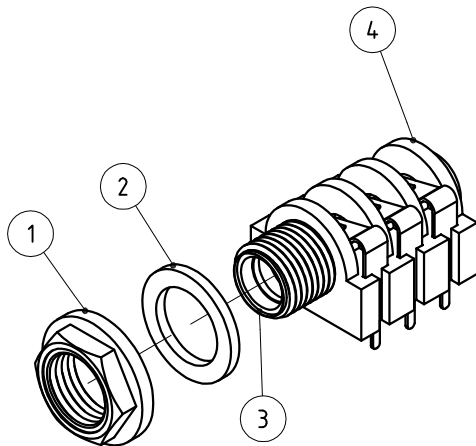
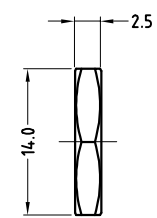

PANEL CUTOUT

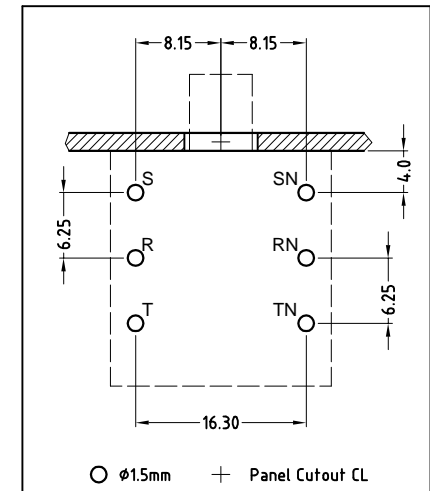

PCB LAYOUT

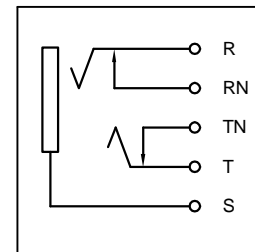

SCHEMATIC

ITEM	DESCRIPTION
1	METAL/PLASTIC NUT
2	FIBRE WASHER
3	METAL TUBE INSERT
4	CONNECTOR ASSEMBLY

PART No.	CATALOG No.	DESCRIPTION
55010099-000	ACJS-MH	METAL NUT
55010099-001	ACJS-PH	PLASTIC NUT

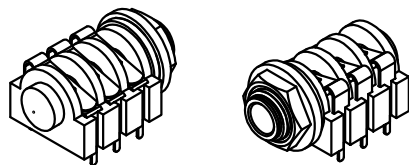

ISO VIEW

UNLESS OTHERWISE SPECIFIED TOLERANCE TO BE		THIS DOCUMENT IS THE PROPERTY OF AMPHENOL AUSTRALIA PTY. LTD.. NO PART THEREOF MAY BE REPRODUCED AND USED WITHOUT THE PRIOR WRITTEN CONSENT OF THE OWNER			
LINEAR	ANGULAR	CAD FILE:	DRN:	DATE:	17-10-01
X ± 0.5	X° ± 1°	55010099000111	L.V	DATE:	13-01-06
X.X ± 0.1	X°X' ± 30'	MATL: REFER TO COMPONENT	CKD:	M.N.H	
X.XX ± 0.05	X°X'X" ± 15'	FINISH: REFER TO COMPONENT	APP'D:	P.M	
BREAK ALL SHARP EDGES AND REMOVE ALL BURRS		SCALE: 2:1 UOS			
DO NOT SCALE		PART No: REFER TO TABLE			
DIMENSIONS IN MILLIMETRES		THIRD ANGLE PROJECTION			

1	CHANGE DRAWING NUMBER & PART VARIATION NUMBER	L.V	07-07-04	8293
0	FIRST ISSUE	L.V	17-10-01	----
REV.	CHANGE DETAILS	BY	DATE	CHG/No
TITLE: 1/4" STEREO JACK PCB LUG		Amphenol		
CUSTOMER DRAWING		Amphenol Australia Pty Ltd, 2 Fineways Blvd, Keysborough, Vic 3173		
DRAWING NO. 55010099-000-1		SHEET 1 OF 1		

## X-ON Electronics

Largest Supplier of Electrical and Electronic Components

*Click to view similar products for [Phone Connectors](#) category:*

*Click to view products by [Amphenol](#) manufacturer:*

Other Similar products are found below :

[M444B](#) [6J1041A](#) [R4F](#) [E12BPKG](#) [ECP4PKG](#) [161-3502L-E](#) [MT333X](#) [171-0350-EX](#) [171-101A-EX](#) [171-3325-EX](#) [176S](#) [NC3MG-V](#)  
[NYS228G](#) [P10834](#) [P2380](#) [P2381X](#) [P2411X](#) [P2412](#) [P2724](#) [JM2PB-AU BULK](#) [9144](#) [S2674](#) [280L](#) [163-156N-2-E](#) [163-158N-2-E](#) [171-3308-](#)  
[EX](#) [171-3500-E](#) [2501FT](#) [CMT335](#) [M10662](#) [330Q](#) [RJ5VI-S](#) [40116](#) [TM1R-AU](#) [TM2PBMJ-AU](#) [TM2PJ-AU](#) [TM2PJ-AU BULK](#) [4803.1351](#)  
[49201](#) [49205](#) [TS3PBJ-AU](#) [TS3PBMJ-AU](#) [TT32BX](#) [54B](#) [40112](#) [40205](#) [415](#) [XMT332B](#) [52170017-331](#) [570](#)