

**ISO VIEW**  
SCALE 1:1

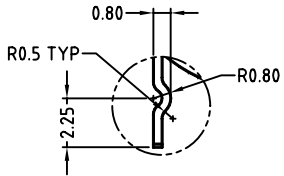

**DETAIL A**  
SCALE 4:1

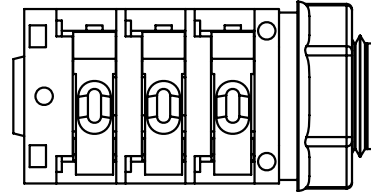
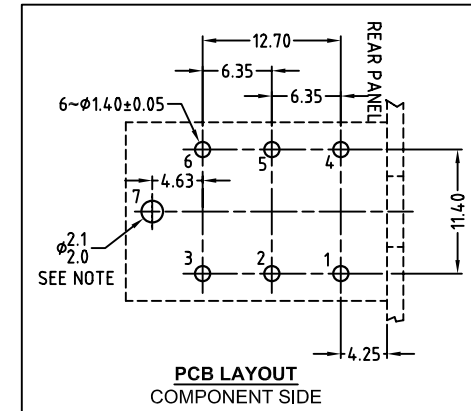
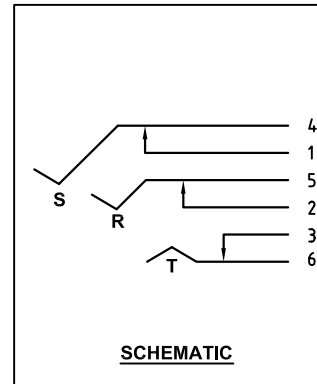
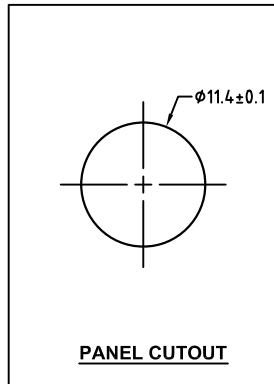
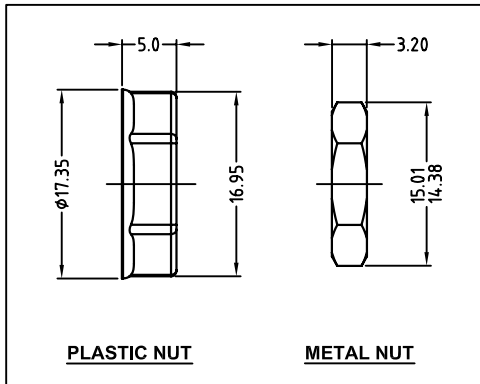
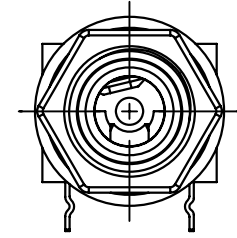
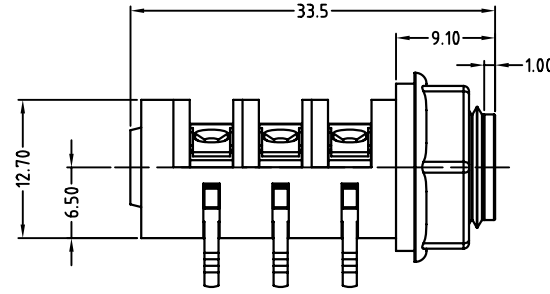
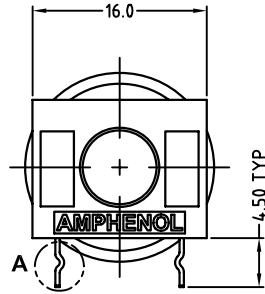

CATALOGUE P/N	ASSEMBLY P/N	NUT OPTIONS
ACJS-PHDR	55010154-502	PLASTIC
ACJS-MHDR	55010154-302	METAL

**NOTE:** OPTIONAL MOUNTING HOLE FOR SELF-TAPPING M2 SCREW

UNLESS OTHERWISE SPECIFIED TOLERANCE TO BE

LINEAR	ANGULAR
X ± 0.5	X° ± 1°
X.X ± 0.1	X°X' ± 30'
X.XX ± 0.05	X°X'X" ± 15"

BREAK ALL SHARP EDGES AND REMOVE ALL BURRS

DO NOT SCALE

DIMENSIONS IN MILLIMETRES

THIS DOCUMENT IS THE PROPERTY OF AMPHENOL AUSTRALIA PTY. LTD. NO PART THEREOF MAY BE REPRODUCED AND USED WITHOUT THE PRIOR WRITTEN CONSENT OF THE OWNER

CAD FILE: 55010154502222 DRN: L.V DATE: 18-06-02

MATL: REFER TO COMPONENTS CKD: M.N.H DATE: 17-05-06

FINISH: REFER TO COMPONENTS APP'D: P.M DATE: 17-05-06

SCALE: 2:1 UOS PART No: REFER TO CHART

2	CHANGE PLASTIC NUT FROM P/N: 52170018-531 TO P/N: 52170032-531	L.V	31-01-05	8333
1	UPDATE TO COMPLY WITH MODIFIED COMPONENTS	L.V	11-06-03	8184
0	FIRST ISSUE	L.V	18-06-02	----
REV.	CHANGE DETAILS	BY	DATE	CHG/No

**TITLE:**  
1/4" PHONE STEREO JACK  
CUSTOMER DRAWING

**Amphenol**  
Amphenol Australia Pty.Ltd, 2 Fireways Blvd, Keysborough, Vic3173  
DRAWING No. SHEET

55010154-502-2 2 OF 2

## X-ON Electronics

Largest Supplier of Electrical and Electronic Components

*Click to view similar products for [Phone Connectors](#) category:*

*Click to view products by [Amphenol](#) manufacturer:*

Other Similar products are found below :

[M444B](#) [6J1041A](#) [R4F](#) [E12BPKG](#) [ECP4PKG](#) [161-3502L-E](#) [MT333X](#) [171-0350-EX](#) [171-101A-EX](#) [171-3325-EX](#) [176S](#) [NC3MG-V](#)  
[NYS228G](#) [P10834](#) [P2380](#) [P2381X](#) [P2411X](#) [P2412](#) [P2724](#) [JM2PB-AU BULK](#) [9144](#) [S2674](#) [280L](#) [163-156N-2-E](#) [163-158N-2-E](#) [171-3308-](#)  
[EX](#) [171-3500-E](#) [2501FT](#) [CMT335](#) [M10662](#) [330Q](#) [RJ5VI-S](#) [40116](#) [TM1R-AU](#) [TM2PBMJ-AU](#) [TM2PJ-AU](#) [TM2PJ-AU BULK](#) [4803.1351](#)  
[49201](#) [49205](#) [TS3PBJ-AU](#) [TS3PBMJ-AU](#) [TT32BX](#) [54B](#) [40112](#) [40205](#) [XMT332B](#) [52170017-331](#) [570](#) [NM3](#)