

FIBRE WASHER

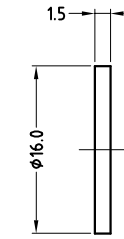

**NUT OPTIONS**

PLASTIC NUT

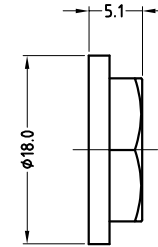

METAL NUT

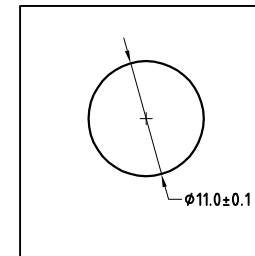
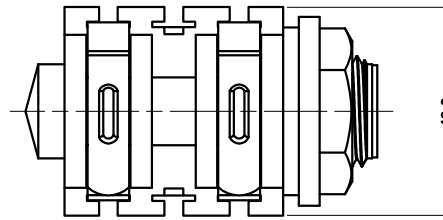
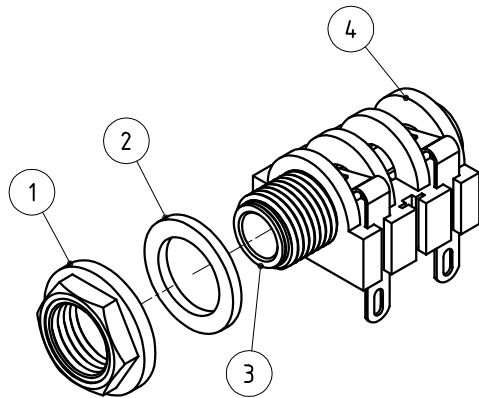
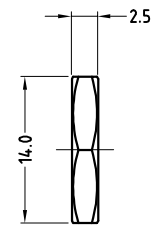

PANEL CUTOUT

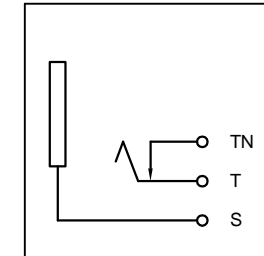

SCHEMATIC

ITEM	DESCRIPTION
1	METAL/PLASTIC NUT
2	FIBRE WASHER
3	METAL TUBE INSERT
4	CONNECTOR ASSEMBLY

PART No.	CATALOG No.	DESCRIPTION
55010292-000	ACJM-MHS	METAL NUT
55010292-001	ACJM-PHS	PLASTIC NUT

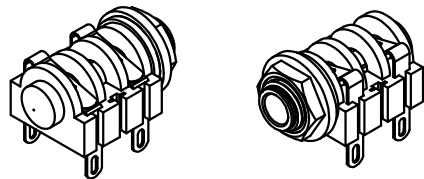

ISO VIEW

UNLESS OTHERWISE SPECIFIED TOLERANCE TO BE	
LINEAR	ANGULAR
X ± 0.5	X° ± 1°
X.X ± 0.1	X°X' ± 30'
X.XX ± 0.05	X°X'X" ± 15"

BREAK ALL SHARP EDGES AND REMOVE ALL BURRS

DO NOT SCALE

DIMENSIONS IN MILLIMETRES

THIS DOCUMENT IS THE PROPERTY OF AMPHENOL AUSTRALIA PTY. LTD.. NO PART THEREOF MAY BE REPRODUCED AND USED WITHOUT THE PRIOR WRITTEN CONSENT OF THE OWNER

CAD FILE: 55010292000111

MATL: REFER TO COMPONENT

FINISH: REFER TO COMPONENT

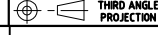

DRN: L.V DATE: 17-10-01

CKD: M.N.H DATE: 13-01-06

APP'D: P.M DATE: 13-01-06

SCALE: 2:1 UOS

REV.	CHANGE DETAILS	BY	DATE	CHG/No
1	CHANGE PART VARIATION NUMBER IN TABLE UPDATE DRAWING TO CURRENT PART	L.V	07-07-04	8293
0	FIRST ISSUE	L.V	17-10-01	----

TITLE: **ACJM-MHS/ACJM-PHS 1/4" MONO JACK CUSTOMER DRAWING**

**Amphenol**  
Amphenol Australia Pty Ltd, 2 Finesops Blvd, Keysborough, Vic 3173

DRAWING NO. SHEET  
55010292-000-1 1 OF 1

## X-ON Electronics

Largest Supplier of Electrical and Electronic Components

*Click to view similar products for [Phone Connectors](#) category:*

*Click to view products by [Amphenol](#) manufacturer:*

Other Similar products are found below :

[M444B](#) [6J1041A](#) [R4F](#) [E12BPKG](#) [ECP4PKG](#) [161-3502L-E](#) [MT333X](#) [171-0350-EX](#) [171-101A-EX](#) [171-3325-EX](#) [176S](#) [NC3MG-V](#)  
[NYS228G](#) [P10834](#) [P2380](#) [P2381X](#) [P2411X](#) [P2412](#) [P2724](#) [JM2PB-AU BULK](#) [9144](#) [S2674](#) [280L](#) [163-156N-2-E](#) [163-158N-2-E](#) [171-3308-](#)  
[EX](#) [171-3500-E](#) [2501FT](#) [CMT335](#) [M10662](#) [330Q](#) [RJ5VI-S](#) [40116](#) [TM1R-AU](#) [TM2PBMJ-AU](#) [TM2PJ-AU](#) [TM2PJ-AU BULK](#) [4803.1351](#)  
[49201](#) [49205](#) [TS3PBJ-AU](#) [TS3PBMJ-AU](#) [TT32BX](#) [54B](#) [40112](#) [40205](#) [XMT332B](#) [52170017-331](#) [570](#) [NM3](#)