

7	8
Rev.	DESCRIPTION

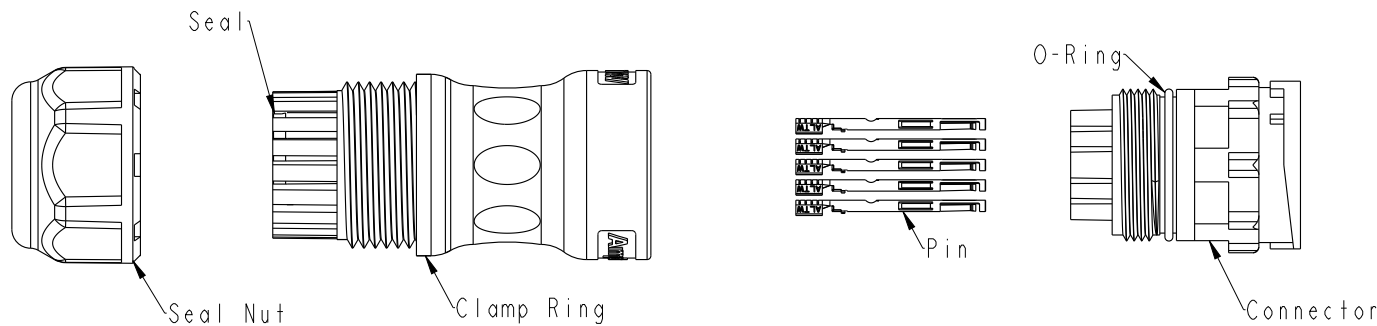

Material Specification:

- \* Connector: Nylon+GF, Black.
- \* Pins: Copper Alloy, Gold Plated.
- \* Seal & O-Ring: Silicone, Gray.
- \* UL Rated: UL 94V-0, fl.
- \* RoHS Compliant.

Electrical Specification:

- \* Contact Resistance: 10mΩ Max.
- \* Insulation Resistance: 100MΩ Min.
- \* Dielectric Withstand Voltage: 1,600 Vac.

Mechanical Specification:

- \* Durability: 1000 Cycles.
- \* Tensile strength: 10 kgf.
- \* Wire Conductor:
  - 5A: 22AWG~20AWG
- \* Wire Insulation OD:
  - 5A: 1.9mm Max.
- \* Torque Force for Clamp Ring: 6~8 kgf-cm
- \* Torque Force for Seal Nut: 6~8 kgf-cm

Environmental Specification:

- \* Waterproof Rating: IP67(Mated)
- \* Temperature Range: -40°C to 105°C.
- \* Salt Spray: Mated, 1000 Hours.
- \* Safety Compliance: UL 1977.

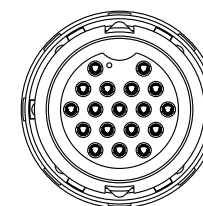
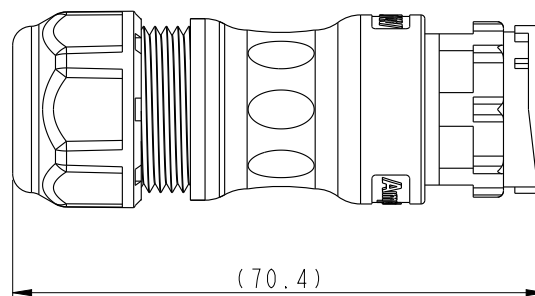
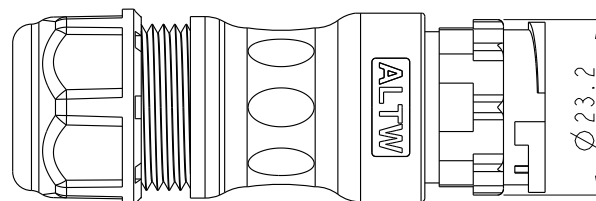

UNIT:mm

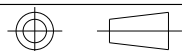

TITLE  
Circular D-Size Field Installable  
Cable Type M Conn

**Amphenol LTW**  
安費諾亮泰企業股份有限公司

ITEM NO	DRAWN BY	DATE
DWG NO	CHECKED BY	DATE
CUSTOMER	APPROVED BY	DATE
ALTW	Peng	2018-12-15
	Mafei	2018-12-15
	Jerry	2018-12-15

SCALE	SIZE	SHEET	OF
8:5	A4	1	2
REV.	WC-REV.	QC: Inspection item	
A	A.3		

THIS DOCUMENT IS SUBJECT TO CHANGE WITHOUT NOTICE. IT IS CONFIDENTIAL AND A PROPERTY OF Amphenol LTW. DISCLOSURE TO THIRD PARTY HAS TO BE AUTHORIZED BY Amphenol LTW.

Ordering Information:

ADD-18BMC-LL7XXX

O: For Data  
P: For Power

P: With Pin  
N: With Out Pin

A: With Red&Yellow&Blue Color Seal  
S: With Red Color Seal, Cable OD 8.0~10.0mm.  
M: With Yellow Color Seal, Cable OD 10.0~12.0mm.  
L: With Blue Color Seal, Cable OD 12.0~14.0mm.

Contacts Gendor  
M: Male Pin  
F: Female Pin

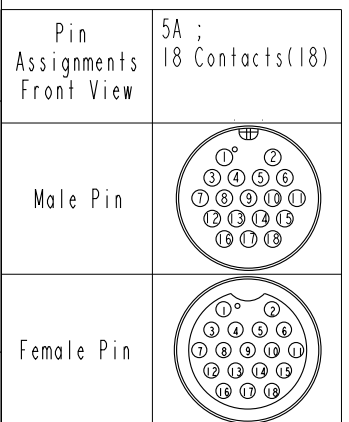

UNIT:mm		TITLE Circular D-Size Field Installable Cable Type M Conn
TOLERANCE ±0.5 mm	SCALE 8:5	SIZE A4
	REV. A	SHEET 2 OF 2
	WC-REV. A.3	QC: Inspection item

**Amphenol LTW**  
安費諾亮泰企業股份有限公司

ITEM NO	DRAWN BY Peng	DATE 2018-12-15
DWG NO ADD-18BMC-LL7XXX	CHECKED BY Mafei	DATE 2018-12-15
CUSTOMER ALTW	APPROVED BY Jerry	DATE 2018-12-15

## X-ON Electronics

Largest Supplier of Electrical and Electronic Components

*Click to view similar products for [Circular Metric Connectors](#) category:*

*Click to view products by [Amphenol](#) manufacturer:*

Other Similar products are found below :

[600X518037X](#) [6STD15PCR99B70A](#) [8R4000A16M020](#) [8R5000A16M005](#) [1200910002](#) [1203580030](#) [1200910008](#) [1200910011](#) [1300140094](#)  
[130203-0054](#) [1300140026](#) [1300150099](#) [1-3637-600-5205](#) [1612618](#) [21036836414](#) [8R4006A16M010](#) [1R3006A20M005](#) [41-40011](#) [42-00006](#)  
[42-01015](#) [4-22279-4](#) [4-22281-1](#) [4-22284-9](#) [43-00113](#) [43-01203](#) [41-40013](#) [42-00008](#) [43-00343](#) [43-01026](#) [43-01162](#) [43-01173](#) [43-10000](#)  
[XS3P-M421-2](#) [600X518050X](#) [8R5006A16M020](#) [8R5006A16M005](#) [8R4000A16M010](#) [6-22279-3](#) [1605332](#) [N03FA03144](#) [1300140077](#) [43-](#)  
[16213](#) [43-01338](#) [XS2RD4265](#) [XS2R-D426-1](#) [XS8A-0441](#) [859RD04-103R004](#) [860RD04-113R004](#) [860RD04-213R004](#) [1-213245-2](#)