

REVISIONS					
REV	ECO	DESCRIPTION	DATE	BY	APPR
A1	--	RELEASED	16MAR2020	J. HEAD	DH

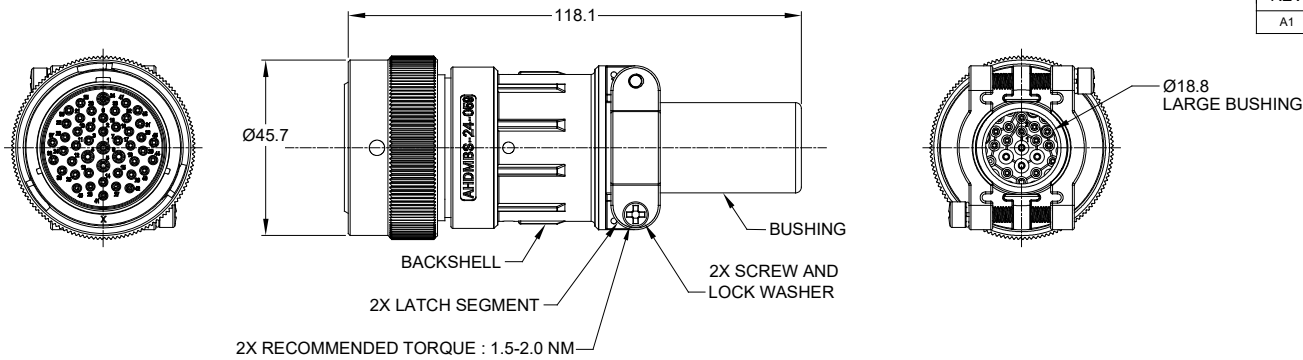

NOTES: UNLESS OTHERWISE SPECIFIED

1. PLUG MATERIAL:
SHELL: ZINC ALLOY, NICKEL PLATED
COUPLING RING: ALUMINUM ALLOY, NICKEL PLATED
INSERT AND RETAINING RING: THERMOPLASTIC
SEAL: SILICONE RUBBER
2. BACKSHELL MATERIAL:
SHELL: ALUMINIUM ALLOY, NICKEL PLATED;
LATCH SEGMENT: ALUMINIUM ALLOY, NICKEL PLATED;
SCREW AND LOCK WASHER: STAINLESS STEEL;
BUSHING: EPDM.
3. SPECIFICATIONS:
3.1 OPERATING TEMPERATURE: -55°C TO +125°C.
3.2 DIELECTRIC WITHSTANDING VOLTAGE: LESS THAN 2 MILLIAMPS CURRENT LEAKAGE @ 1500 VOLTS AC.
3.3 INSULATION RESISTANCE: 1000 MEGOHM MIN @ 25°C.
3.4 MOISTURE RESISTANCE: IP67 & IP69K (MATED CONDITION).
3.5 MATING CYCLE DURABILITY: 100 CYCLES
3.6 RoHS COMPLIANT
4. APPLY TO CABLE OD SIZE: Ø11.20-Ø24.08 . CAN BE USED:
4.1. WITH LARGE AND SMALL BUSHINGS IN PLACE.
4.2. WITH ONLY LARGE BUSHING IN PLACE.
4.3. WITH BOTH BUSHINGS REMOVED.
5. ALL DIMENSIONS ARE FOR REFERENCE USE ONLY.
6. SEE SPECIFIC PLUG DRAWING FOR:
6.1 CONTACT SIZE AND WIRE RANGE.
6.2 RETAINING RING COLOR.
6.3 MATING PART(S).
6.4 CONTACT LAYOUT AND ALL OTHER SPECIFICATIONS.

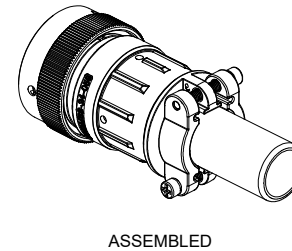

ASSEMBLED

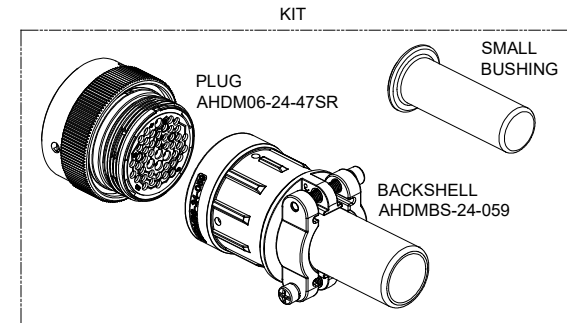

AHDM06-24-47SR-059		HD36-24-47SE-059	
PART NUMBER		DESCRIPTION	
QUANTITY		ITEM	
MATERIALS LIST			
UNLESS OTHERWISE SPECIFIED			
1) All dimensions are in metric (mm).			
2) Tolerances are as follows:			
1 PL DEC ±0.30	Fractions ±1/64		
2 PL DEC ±0.15	Angles ±1°		
3 PL DEC ±0.08			
3) Note reference =			
SIGNATURES		DATE	
DRAWN: J. HEAD		16MAR2020	
CHECKED:			
ENGINEER:			
APPROVAL:			
MATERIAL SPECIFICATIONS:		CUSTOMER:	
PROCESS SPECIFICATIONS:		THIS DRAWING IS SUPPLIED FOR INFORMATION ONLY. DESIGN FEATURES, SPECIFICATIONS AND PERFORMANCE DATA SHOWN HEREON ARE THE PROPERTY OF THE AMPHENOL CORPORATION. NO RIGHTS OF REPRODUCTION ARE IMPLIED. ALL DIMENSIONS ARE SUBJECT TO NORMAL MANUFACTURING VARIATIONS.	
NEXT ASSY:		SCALE: NONE	
		SHEET 1 OF 1	

Amphenol
Sine Systems - www.amphenol-sine.com
44724 Morley Drive
Clinton Township, MI 48036

DURAMATE AHDM PLUG, SIZE 24, WD THD, KIT W/ CABLE CLAMP BACKSHELL



SIZE: **B C-** DWG NO: **AHDM06-24-47SR-059** REVISION: **A1**

TITLE: KIT, PLUG AND BACKSHELL, SZ 24 DWG NO: AHDM06-24-47SR-059 REV: A1 SH: 1 OF: 1



ATM Series™ - Contact Size 20 Options

Machined Contacts, Sockets & Pins				
Part Number	Description	Size	AWG	Type
AT60-010-2031	Male Contact - Pin, Gold-plated	20	16-18	Machined
AT62-005-20141	Female Contact - Socket, Gold-plated	20	16-18	Machined
AT60-010-20141	Male Contact - Pin, Nickel-plated	20	16-18	Machined
AT62-005-2031	Female Contact - Socket, Nickel-plated	20	16-18	Machined
AT60-202-2031	Male Contact - Pin, Gold-plated	20	20-22	Machined
AT62-201-2031	Female Contact - Socket, Gold-plated	20	20-22	Machined
AT60-202-20141	Male Contact - Pin, Nickel-plated	20	20-22	Machined
AT62-201-20141	Female Contact - Socket, Nickel-plated	20	20-22	Machined

Tooling - Machined Contacts		
Part	Part Number	Description
	CA-5D12	Universal Hand Crimp Tool, Size 12/16/20 (Machined contacts only)
	CA-5E12	Pneumatic Crimp Tool, Size 12/16/20 (Machined contacts only)

Contact Removal Tools		
Part	Part Number	Description
	ATRT-100	Used for removal of contacts for A Series™ products
	AT11-240-2005	Contact Removal Tool, Plastic, Size 20
	AT13-204-2005	Sealing Plug, Size 20, White



Stamped & Formed Contacts, Sockets & Pins				
Part Number	Description	Size	AWG	Type
AT60-20-0144	Male Contact - Pin, Gold-plated	20	16-22	Stamped & Formed
AT62-20-0144	Female Contact - Socket, Gold-plated	20	16-22	Stamped & Formed
AT60-20-0244	Male Contact - Socket, Gold-plated	20	16-22	Stamped & Formed
AT62-20-0244	Female Contact - Socket, Gold-plated	20	16-22	Stamped & Formed
AT60-20-0122	Male Contact - Pin, Nickel-plated	20	16-22	Stamped & Formed
AT62-20-0122	Female Contact - Socket, Nickel-plated	20	16-22	Stamped & Formed
AT60-20-0222	Male Contact - Socket, Nickel-plated	20	16-22	Stamped & Formed
AT62-20-0222	Female Contact - Socket, Nickel-plated	20	16-22	Stamped & Formed
AT60-20-0277	Male Contact - Socket, Tin-plated	20	16-22	Stamped & Formed
AT62-20-0277	Female Contact - Socket, Tin-plated	20	16-22	Stamped & Formed
AT60-20-0422	Male Contact - Socket, Nickel-plated	20	20-22	Stamped & Formed
AT62-20-0444	Female Contact - Socket, Gold-plated	20	20-22	Stamped & Formed



Tooling - Stamped & Formed Contacts		
Part	Part Number	Description
	MFX-3974	Crimp Die - Size 20 (S&F contacts only)
	MFX-3976	Crimp Die - Size 20 (S&F contacts only) 20-22AWG -04XX Series
	MFX-3978	Crimp Die - Size 20 (S&F contacts only) 20-22AWG -02XX Series
	ATT-20-00	Hand Crimp Tool - Size 20, 20AWG (S&F contacts only)

Amphenol Sine Systems
 44724 Morley Drive
 Clinton Township, MI 48036 USA
www.amphenol-sine.com
 09/2021

AT Series™ - Contact Size 16 Options

Machined Contacts, Sockets & Pins				
Part Number	Description	Size	AWG	Type
AT60-215-1631	Male Contact - Pin, Gold-plated	16	14	Machined
AT62-209-1631	Female Contact - Socket, Gold-plated	16	14	Machined
AT60-215-16141	Male Contact - Pin, Nickel-plated	16	14	Machined
AT62-209-16141	Female Contact - Socket, Nickel-plated	16	14	Machined
AT60-202-1631	Male Contact - Pin, Gold-plated	16	16-20	Machined
AT62-201-1631	Female Contact - Socket, Gold-plated	16	16-20	Machined
AT60-202-16141	Male Contact - Pin, Nickel-plated	16	16-20	Machined
AT62-201-16141	Female Contact - Socket, Nickel-plated	16	16-20	Machined
AT60-202-1631-22	Male Contact - Pin, Gold-plated	16	22-24	Machined
AT62-201-1631-22	Female Contact - Socket, Gold-plated	16	22-24	Machined
AT60-202-16141-22	Male Contact - Pin, Nickel-plated	16	22-24	Machined
AT62-201-16141-22	Female Contact - Socket, Nickel-plated	16	22-24	Machined

Tooling - Machined Contacts		
Part	Part Number	Description
	CA-5D12	Universal Hand Crimp Tool, Size 12/16/20 (Machined contacts only)
	CA-5E12	Pneumatic Crimp Tool, Size 12/16/20 (Machined contacts only)

Contact Removal Tools		
Part	Part Number	Description
	ATRT-100	Used for removal of contacts for A Series™ products
	AT11-310-1605	Contact Removal Tool, Plastic, Size 16
	A114017	Sealing Plug, Size 16, White

Stamped & Formed Contacts, Sockets & Pins				
Part Number	Description	Size	AWG	Type
AT60-14-0144	Male Contact - Pin, Gold-plated	16	14-16	Stamped & Formed
AT62-14-0144	Female Contact - Socket, Gold-plated	16	14-16	Stamped & Formed
AT60-14-0122	Male Contact - Pin, Nickel-plated	16	14-16	Stamped & Formed
AT62-14-0122	Female Contact - Socket, Nickel-plated	16	14-16	Stamped & Formed
AT60-16-0144	Male Contact - Pin, Gold-plated	16	16-18	Stamped & Formed
AT62-16-0144	Female Contact - Socket, Gold-plated	16	16-18	Stamped & Formed
AT60-16-0122	Male Contact - Pin, Nickel-plated	16	16-18	Stamped & Formed
AT62-16-0122	Female Contact - Socket, Nickel-plated	16	16-18	Stamped & Formed
AT60-16-0644	Male Contact - Pin, Gold-plated	16	18-20	Stamped & Formed
AT62-16-0644	Female Contact - Socket, Gold-plated	16	18-20	Stamped & Formed
AT60-16-0622	Male Contact - Pin, Nickel-plated	16	18-20	Stamped & Formed
AT62-16-0622	Female Contact - Socket, Nickel-plated	16	18-20	Stamped & Formed
AT60-16-0844	Male Contact - Pin, Gold-plated	16	20-22	Stamped & Formed
AT62-16-0844	Female Contact - Socket, Gold-plated	16	20-22	Stamped & Formed
AT60-16-0822	Male Contact - Pin, Nickel-plated	16	20-22	Stamped & Formed
AT62-16-0822	Female Contact - Socket, Nickel-plated	16	20-22	Stamped & Formed

Tooling - Stamped & Formed Contacts		
Part	Part Number	Description
	MFX-3950	Crimp Die - Size 16, 18-20AWG (S&F contacts only)
	MFX-3953	Crimp Die - Size 16, 16-18AWG (S&F contacts only)
	MFX-3975	Crimp Die - Size 16, 14-16AWG (S&F contacts only)
	MFX-3990	Crimp Die - Size 16, 20-22AWG (S&F contacts only)
	ATT-16-00	Hand Crimp Tool - Size 16, 14-16AWG (S&F contacts only)
	ATT-16-01	Hand Crimp Tool - Size 16, 18-20AWG (S&F contacts only)
	ATT-1612-03	Hand Crimp Tool - Size 16, 20-22AWG (S&F contacts only)

Amphenol Sine Systems
 44724 Morley Drive
 Clinton Township, MI 48036 USA
www.amphenol-sine.com
 09/2021

X-ON Electronics

Largest Supplier of Electrical and Electronic Components

Click to view similar products for [Standard Circular Connector](#) category:

Click to view products by [Amphenol](#) manufacturer:

Other Similar products are found below :

[5M2530B10P](#) [600259N006](#) [600273N007](#) [6134-336-13149](#) [6134-337-11149](#) [6134-337-2390](#) [6134-341-17149](#) [6280-4SG-516](#) [6280-7SG-3DC](#)
[6290](#) [6291A](#) [66200A-10](#) [680-SMG](#) [681-PMG](#) [CXS3102A14S2P](#) [CXS3102A181S](#) [7251-6SG-300](#) [7271-6SG-300](#) [7282-3PG-300-CH3](#) [75-](#)
[474014-05S](#) [75-474618-01S](#) [75-474618-04P](#) [75-474618-04S](#) [799539-000](#) [MI8-SE](#) [805-005-07NF11-19PC](#) [805-005-07NF15-7PA](#) [8280-4PG-](#)
[516](#) [8280-7PG-519](#) [8282-5PG-519](#) [836783-1](#) [MP-4102-25P-C](#) [862256-1](#) [864019-2](#) [866857-1](#) [867865-1](#) [PT01SP-14-18P](#) [PT08P-14-5S](#)
[PTSF06SE-14-12S](#) [120-1833-000](#) [QCM019PC2DC012B](#) [1-2069279-1](#) [121583-0217](#) [121667-0020](#) [129591AU](#) [1000B BULK](#) [RD10A16-19-](#)
[P6CS051/1](#) [RD10A20-31-P8CS051/1](#) [RD16A14-12-S6CS051/2](#) [1301240290](#) [1301240347](#)