

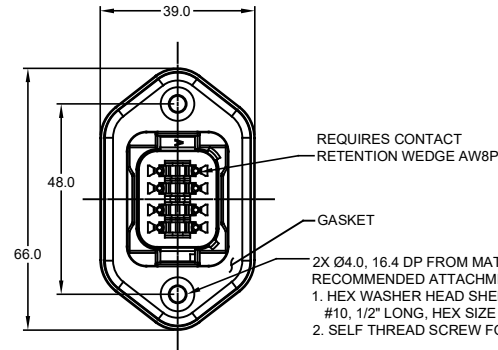

MOUNTING PLATE SIZE

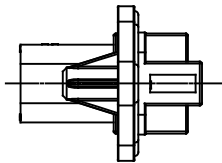

△ STANDARD OR REDUCED DIAMETER SEAL

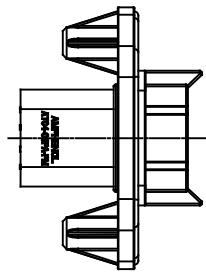
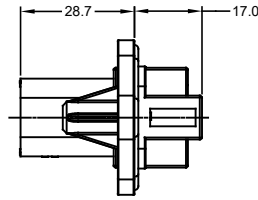
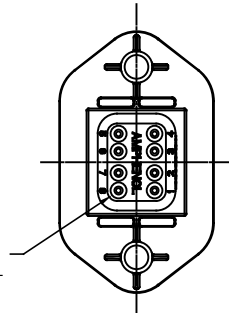

NOTES: UNLESS OTHERWISE SPECIFIED

1. MATERIAL:
 - HOUSING: THERMOPLASTIC; COLOR: PER KEY OPTION
 - END CAP: THERMOPLASTIC; COLOR: BLACK
 - STRAIN RELIEF CAP: THERMOPLASTIC; COLOR: BLACK
 - SEALS: SILICONE RUBBER; COLOR: RED
2. MODIFICATIONS: FLANGE, GASKET, END CAP (OPT), STRAIN RELIEF CAP (OPT), REDUCED DIAMETER SEAL (OPT).
3. SPECIFICATIONS:
 - 3.1 CURRENT RATING: 13 AMPS
 - 3.2 OPERATING TEMPERATURE: -55°C TO +125°C
 - 3.3 DIELECTRIC WITHSTANDING VOLTAGE: LESS THAN 2 MILLIAMPS CURRENT LEAKAGE @ 1500 VOLTS AC.
 - 3.4 INSULATION RESISTANCE: 1000 MEGOHMS MIN @ 25°C.
 - 3.5 MOISTURE RESISTANCE: IP67 (MATED CONDITION)
 - 3.6 MATING CYCLE DURABILITY: 100 CYCLES
 - 3.7 RoHS COMPLIANT
4. MATING PART: AT06-08SX* PLUG
(X = A,B,C,D KEYS; * = MODIFICATIONS AND COLORS)
5. ALL DIMENSIONS ARE FOR REFERENCE USE ONLY.

△ CONTACT SIZE AND REAR SEAL WIRE RANGE

REDUCED DIAMETER SEAL:

CONTACT SIZE	MIN. INSUL O.D.	MAX. INSUL O.D.	TYPICAL WIRE RANGE
16	1.35 mm (.053 in)	3.05 mm (.120 in)	14 - 20 AWG

STANDARD SEAL:

CONTACT SIZE	MIN. INSUL O.D.	MAX. INSUL O.D.	TYPICAL WIRE RANGE
16	2.24 mm (.088 in)	3.68 mm (.145 in)	14 - 20 AWG

REVISIONS					
REV	ECO	DESCRIPTION	DATE	BY	APPR
A1	-	RELEASE	29JUN15	JAH	
A2	-	UPDATE APPEARANCE	20APR16	JARRY	TOMMY
A3	-	ADDED -15 & -16 OPTIONS ADDED COLORS TO NOTE #1	23MAR18	JAH	

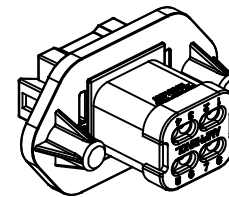

SHOWN WITH END CAP

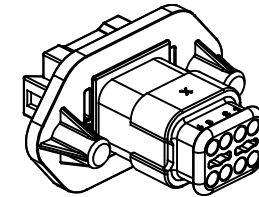

SHOWN WITH STRAIN RELIEF

SEE SHEET 2 FOR KEYS					
PART NUMBER		DESCRIPTION		ITEM	
QUANTITY	MATERIALS LIST				
UNLESS OTHERWISE SPECIFIED		SIGNATURES		DATE	
1) All dimensions are in metric (mm).		DRAWN: J. HEAD		14JUL15	
2) Tolerances are as follows:		CHECKED:			
1 PL DEC ±0.30		ENGINEER:			
2 PL DEC ±0.15		APPROVAL:			
3 PL DEC ±0.08		CUSTOMER:			
3) Note reference = △		FRACTIONS ±1/64		Angles ±1°	
MATERIAL SPECIFICATIONS:		THIS DRAWING IS SUPPLIED FOR INFORMATION ONLY. DESIGN FEATURES, SPECIFICATIONS AND PERFORMANCE DATA SHOWN HEREON ARE THE PROPERTY OF THE AMPHENOL CORPORATION. NO RIGHTS OF REPRODUCTION ARE IMPLIED. ALL DIMENSIONS ARE SUBJECT TO NORMAL MANUFACTURING VARIATIONS.		<p>Amphenol</p> <p>Sine Systems - www.amphenol-sine.com 44724 Morley Drive Clinton Township, MI 48036</p>	
PROCESS SPECIFICATIONS:		NEXT ASSY:		<p>RECEPTACLE, 8 PIN, AT SERIES, W/FLANGE</p>	
		SCALE: NONE		<p>SIZE: B C- DWG NO: AT04-08PX-PMXX REVISION: A3</p>	
		SHEET 1 OF 2			

TITLE: RECEPTACLE, 8 PIN, AT SERIES, W/FLANGE DWG NO.: AT04-08PX-PMXX REV: A3 SH: 1 OF: 2

REVISIONS					
REV	ECO	DESCRIPTION	DATE	BY	APPR
A1	-	RELEASE	14JUL15	JAH	
A2	-	UPDATE APPEARANCE	20APR16	JARRY	TOMMY
A3	-	ADDED -15 & -16 OPTIONS ADDED COLORS TO NOTE #1	23MAR18	JAH	

P/N AT04-08PA-PMXX
KEY-A CONFIGURATION
STANDARD HOUSING COLOR: GREY



KEY-A CONFIGURATION				
PART NUMBER	SEAL	END CAP	STRAIN RELIEF	
AT04-08PA-PM11	STANDARD	NO	NO	
AT04-08PA-PM12	REDUCED DIA.	NO	NO	
AT04-08PA-PM13	STANDARD	YES	NO	
AT04-08PA-PM14	REDUCED DIA.	YES	NO	
AT04-08PA-PM15	STANDARD	NO	YES	
AT04-08PA-PM16	REDUCED DIA.	NO	YES	

P/N AT04-08PB-PMXX
KEY-B CONFIGURATION
STANDARD HOUSING COLOR: BLACK

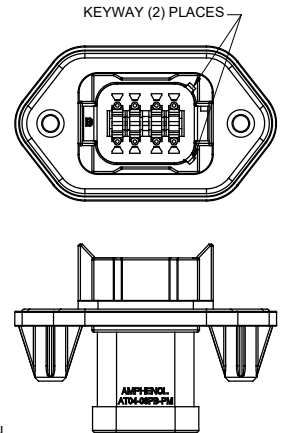

KEY-B CONFIGURATION				
PART NUMBER	SEAL	END CAP	STRAIN RELIEF	
AT04-08PB-PM11	STANDARD	NO	NO	
AT04-08PB-PM12	REDUCED DIA.	NO	NO	
AT04-08PB-PM13	STANDARD	YES	NO	
AT04-08PB-PM14	REDUCED DIA.	YES	NO	
AT04-08PB-PM15	STANDARD	NO	YES	
AT04-08PB-PM16	REDUCED DIA.	NO	YES	

P/N AT04-08PC-PMXX
KEY-C CONFIGURATION
STANDARD HOUSING COLOR: GREEN

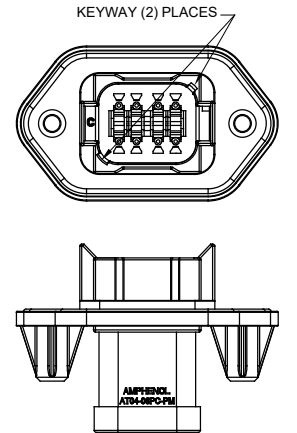

KEY-C CONFIGURATION				
PART NUMBER	SEAL	END CAP	STRAIN RELIEF	
AT04-08PC-PM11	STANDARD	NO	NO	
AT04-08PC-PM12	REDUCED DIA.	NO	NO	
AT04-08PC-PM13	STANDARD	YES	NO	
AT04-08PC-PM14	REDUCED DIA.	YES	NO	
AT04-08PC-PM15	STANDARD	NO	YES	
AT04-08PC-PM16	REDUCED DIA.	NO	YES	

P/N AT04-08PD-PMXX
KEY-D CONFIGURATION
STANDARD HOUSING COLOR: BROWN

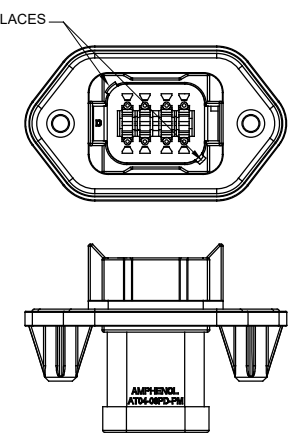

KEY-D CONFIGURATION				
PART NUMBER	SEAL	END CAP	STRAIN RELIEF	
AT04-08PD-PM11	STANDARD	NO	NO	
AT04-08PD-PM12	REDUCED DIA.	NO	NO	
AT04-08PD-PM13	STANDARD	YES	NO	
AT04-08PD-PM14	REDUCED DIA.	YES	NO	
AT04-08PD-PM15	STANDARD	NO	YES	
AT04-08PD-PM16	REDUCED DIA.	NO	YES	

QUANTITY	PART NUMBER	DESCRIPTION	ITEM
MATERIALS LIST			
<small>UNLESS OTHERWISE SPECIFIED</small> 1) All dimensions are in metric (mm). 2) Tolerances are as follows: 1 PL DEC ±0.30 Fractions ±1/64 2 PL DEC ±0.15 Angles ±1° 3 PL DEC ±0.08 3) Note reference =		SIGNATURES DATE DRAWN: J.HEAD 14JUL15 CHECKED: ENGINEER: APPROVAL: CUSTOMER:	<div style="text-align: center;"> <h1>Amphenol</h1> <p>Sine Systems - www.amphenol-sine.com 44724 Morley Drive Clinton Township, MI 48036</p> </div>
MATERIAL SPECIFICATIONS: PROCESS SPECIFICATIONS: NEXT ASSY:		<small>THIS DRAWING IS SUPPLIED FOR INFORMATION ONLY. DESIGN FEATURES, SPECIFICATIONS AND PERFORMANCE DATA SHOWN HEREON ARE THE PROPERTY OF THE AMPHENOL CORPORATION. NO RIGHTS OF REPRODUCTION ARE IMPLIED. ALL DIMENSIONS ARE SUBJECT TO NORMAL MANUFACTURING VARIATIONS.</small>	RECEPTACLE, 8 PIN, AT SERIES, W/FLANGE SIZE: B C- TYPE: DWG NO: AT04-08PX-PMXX REVISION: A3 SCALE: NONE SHEET 2 OF 2

TITLE: RECEPTACLE, 8 PIN, AT SERIES, W/FLANGE
 DWG NO: AT04-08PX-PMXX
 REV: A3
 SH: 2
 OF: 2

X-ON Electronics

Largest Supplier of Electrical and Electronic Components

Click to view similar products for [Automotive Connectors](#) category:

Click to view products by [Amphenol](#) manufacturer:

Other Similar products are found below :

[003-018-000](#) [60403001](#) [60993906-B](#) [M902-2131](#) [M902-2161](#) [72.330.1035.1](#) [73.353.4028.0](#) [F119300-B](#) [F166900](#) [F258300-B](#) [F358300-B](#)
[F407400](#) [F444110](#) [F487000](#) [F509500B-B](#) [827153-1](#) [8N1515-32-24P](#) [9-1326729-8](#) [925474-1](#) [928905-1](#) [964562-4](#) [968782-1](#) [GT17SA-8DS-](#)
[HU](#) [98891-1012](#) [98947-1016](#) [12004475-L](#) [12010290](#) [12010309-B](#) [12015454](#) [12020219-B](#) [12020308](#) [12041318-B](#) [12052225-L](#) [12052466](#)
[12059125](#) [12064869](#) [12004327-B](#) [12010503-B](#) [12015308](#) [12015384](#) [12015909](#) [1-21030-1](#) [12041254](#) [12041318](#) [12047946-B](#) [12047957](#)
[12047957-L](#) [12059473](#) [12066261](#) [12110546](#)