

REVISIONS					
REV	ECO	DESCRIPTION	DATE	BY	APPR
A1	-	RELEASE NEW DRAWING	11APR18	ROOKIE	TOMMY
A2	-	REVISED DESCRIPTION	12JUN19	JAH	DH

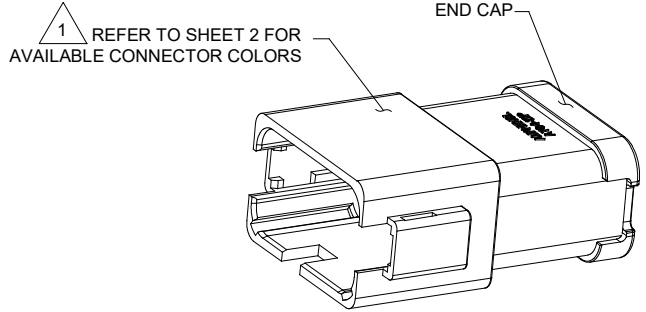
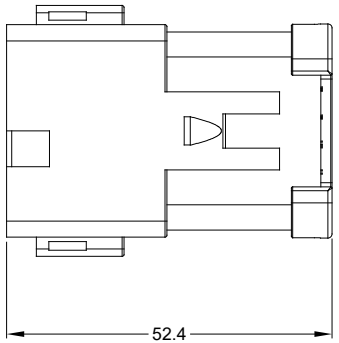
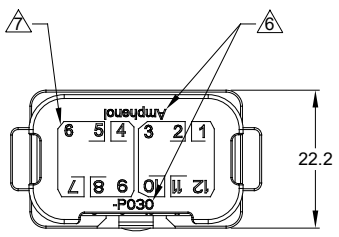
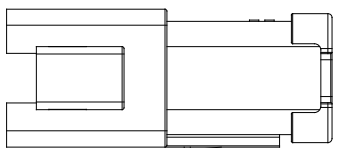
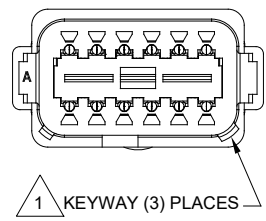
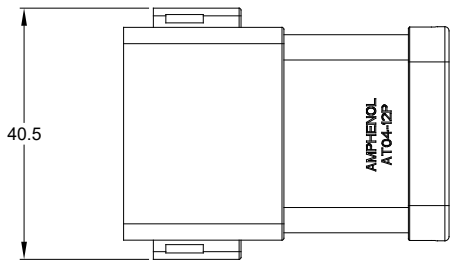

NOTES: UNLESS OTHERWISE SPECIFIED

1 SEE SHEET 2 FOR KEY ARRANGEMENTS AND COLORS.

2. MATERIAL:
HOUSING: THERMOPLASTIC
SEAL: SILICONE RUBBER
CONTACT: COPPER ALLOY

3. MODIFICATIONS: 4 PIECES OF 3 PIN BUSBAR WITH NICKEL PLATED

4. SPECIFICATIONS:
4.1 CURRENT RATING: 13 AMPS MAXIMUM FOR THE 3 PIN BUSBAR
4.2 OPERATING TEMPERATURE: -55°C TO +125°C
4.3 DIELECTRIC WITHSTANDING VOLTAGE: LESS THAN 2 MILLIAMPS CURRENT LEAKAGE @ 1500 VOLTS AC.
4.4 INSULATION RESISTANCE: 1000 MEGOHM MIN @ 25°C.
4.5 MOISTURE RESISTANCE: IP67 (MATED CONDITION).
4.6 MATING CYCLE DURABILITY: 100 CYCLES
4.7 RoHS COMPLIANT

5. MATING PART: AT06-12SX* PLUG
(X=A,B,C,D KEYS * = AVAILABLE MODIFICATIONS)

6. ORIENTATION OF "Amphenol" AND "-P030" TO BE OPTIONAL

7. BORDERS SIGNIFY THAT EACH GROUP OF PINS (PINS 1,11,12 , PINS 2,3,10, PINS 4,8,9 AND PINS 5,6,7) ARE BUSSED TOGETHER WITH A 3 PIN BUSBAR

8. ALL DIMENSIONS ARE FOR REFERENCE USE ONLY.

SEE SHEET 2		REF: DT04-12PA-P030 & DT04-12PB-P030		
PART NUMBER		DESCRIPTION		
QUANTITY	MATERIALS LIST			ITEM
UNLESS OTHERWISE SPECIFIED		SIGNATURES		DATE
1) All dimensions are in metric (mm).		DRAWN: ROOKIE		11APR18
2) Tolerances are as follows:		CHECKED: ORION		11APR18
1 PL DEC ±0.30 Fractions ±1/64		ENGINEER:		
2 PL DEC ±0.15 Angles ±1°		APPROVAL: TOMMY		11APR18
3 PL DEC ±0.08		CUSTOMER:		
3) Note reference =		THIS DRAWING IS SUPPLIED FOR INFORMATION ONLY. DESIGN FEATURES, SPECIFICATIONS AND PERFORMANCE DATA SHOWN HEREON ARE THE PROPERTY OF THE AMPHENOL CORPORATION. NO RIGHTS OF REPRODUCTION ARE IMPLIED. ALL DIMENSIONS ARE SUBJECT TO NORMAL MANUFACTURING VARIATIONS.		
MATERIAL SPECIFICATIONS:		SIZE		REVISION
PROCESS SPECIFICATIONS:		TYPE		
NEXT ASSY:		SCALE		
		B C-		AT04-12PX-P030
		NONE		A2
		DWG NO:		SHEET 1 OF 2

TITLE: HYPERBUSS AT 12WAY RECP 4(3) PIN BUSBAR NICKEL-PLATED
DWG NO: AT04-12PX-P030
REV: A2
SH: 1
OF: 2

REVISIONS					
REV	ECO	DESCRIPTION	DATE	BY	APPR
A1	-	RELEASE NEW DRAWING	11APR18	ROOKIE	TOMMY
A2	-	REVISED DESCRIPTION	12JUN19	JAH	DH

P/N AT04-12PA-P030
KEY-A CONFIGURATION
STANDARD COLOR: GREY

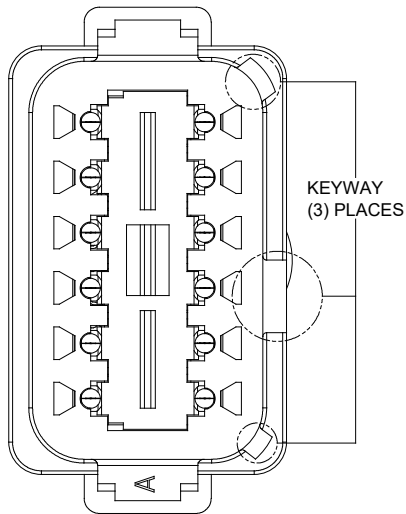

P/N AT04-12PB-P030
KEY-B CONFIGURATION
STANDARD COLOR: BLACK

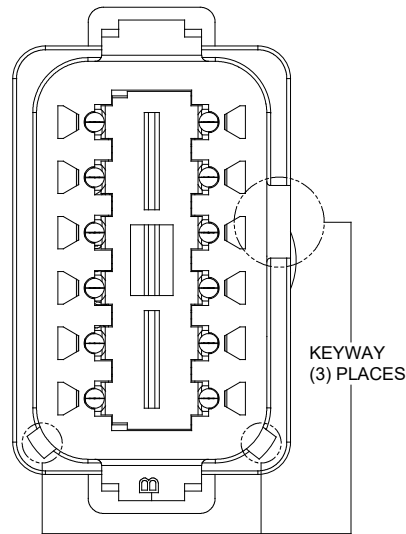

P/N AT04-12PC-P030
KEY-C CONFIGURATION
STANDARD COLOR: GREEN

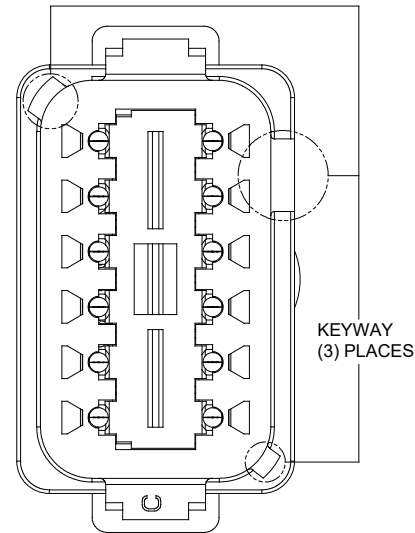

P/N AT04-12PD-P030
KEY-D CONFIGURATION
STANDARD COLOR: BROWN

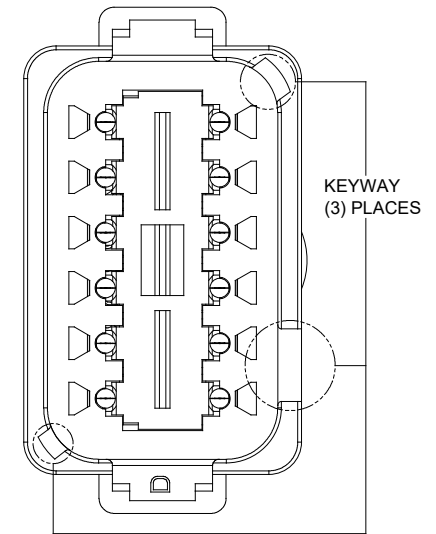

TITLE: HYPERBUSS AT 12WAY RECP (4)3 PIN BUSBAR NICKEL PLATED
DWG NO.: AT04-12PX-P030
REV: A2
SH: 2
OF: 2

PART NUMBER		DESCRIPTION		ITEM
QUANTITY		MATERIALS LIST		
UNLESS OTHERWISE SPECIFIED		SIGNATURES		DATE
1) All dimensions are in metric (mm).		DRAWN: ROOKIE		11APR18
2) Tolerances are as follows:		CHECKED: ORION		11APR18
1 PL DEC ±0.30 Fractions ±1/64		ENGINEER:		
2 PL DEC ±0.15		APPROVAL: TOMMY		11APR18
3 PL DEC ±0.08		CUSTOMER:		
3) Note reference =		HYPERBUSS AT 12WAY RECEPTACLE (4)3 PIN BUSBAR NICKEL-PLATED		
MATERIAL SPECIFICATIONS:		Sine Systems - www.amphenol-sine.com 44724 Morley Drive Clinton Township, MI 48036		
PROCESS SPECIFICATIONS:		THIS DRAWING IS SUPPLIED FOR INFORMATION ONLY. DESIGN FEATURES, SPECIFICATIONS AND PERFORMANCE DATA SHOWN HEREON ARE THE PROPERTY OF THE AMPHENOL CORPORATION. NO RIGHTS OF REPRODUCTION ARE IMPLIED. ALL DIMENSIONS ARE SUBJECT TO NORMAL MANUFACTURING VARIATIONS.		
NEXT ASSY:		SIZE	TYPE	DWG NO.
		B	C-	AT04-12PX-P030
		SCALE	NONE	REVISION
				A2
				SHEET 2 OF 2

X-ON Electronics

Largest Supplier of Electrical and Electronic Components

Click to view similar products for [Automotive Connectors](#) category:

Click to view products by [Amphenol](#) manufacturer:

Other Similar products are found below :

[003-018-000](#) [60403001](#) [60993906-B](#) [M902-2131](#) [M902-2161](#) [72.330.1035.1](#) [73.353.4028.0](#) [F119300-B](#) [F166900](#) [F258300-B](#) [F358300-B](#)
[F407400](#) [F444110](#) [F487000](#) [F509500B-B](#) [827153-1](#) [8N1515-32-24P](#) [9-1326729-8](#) [925474-1](#) [928905-1](#) [964562-4](#) [968782-1](#) [GT17SA-8DS-](#)
[HU](#) [98891-1012](#) [98947-1016](#) [12004475-L](#) [12010290](#) [12010309-B](#) [12015454](#) [12020219-B](#) [12020308](#) [12041318-B](#) [12052225-L](#) [12052466](#)
[12059125](#) [12064869](#) [12004327-B](#) [12010503-B](#) [12015308](#) [12015384](#) [12015909](#) [1-21030-1](#) [12041254](#) [12041318](#) [12047946-B](#) [12047957](#)
[12047957-L](#) [12059473](#) [12066261](#) [12110546](#)