

1 KEYWAY (3) PLACES

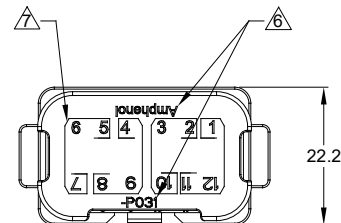

1 REFER TO SHEET 2 FOR AVAILABLE CONNECTOR COLORS

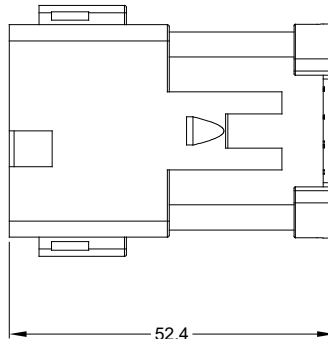
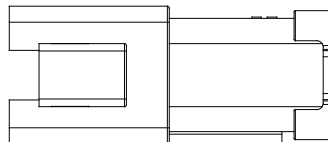
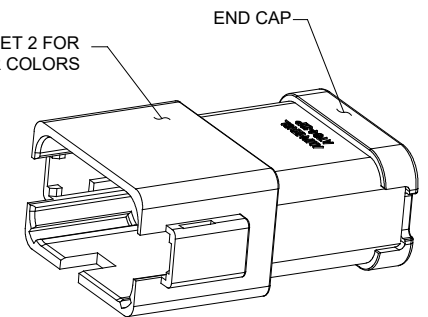

REVISIONS					
REV	ECO	DESCRIPTION	DATE	BY	APPR
A1	-	RELEASE NEW DRAWING	11APR18	ROOKIE	TOMMY
A2	-	REVISED DESCRIPTION	12JUN19	JAH	DH

NOTES: UNLESS OTHERWISE SPECIFIED

1 SEE SHEET 2 FOR KEY ARRANGEMENTS AND COLORS.

2. MATERIAL:
HOUSING: THERMOPLASTIC
SEAL: SILICONE RUBBER
CONTACT: COPPER ALLOY

3. MODIFICATIONS: 4 PIECES OF 3 PIN BUSBAR WITH GOLD PLATED

4. SPECIFICATIONS:
4.1 CURRENT RATING: 13 AMPS MAXIMUM FOR THE 3 PIN BUSBAR
4.2 OPERATING TEMPERATURE: -55°C TO +125°C.
4.3 DIELECTRIC WITHSTANDING VOLTAGE: LESS THAN 2 MILLIAMPS CURRENT LEAKAGE @ 1500 VOLTS AC.
4.4 INSULATION RESISTANCE: 1000 MEGOHM MIN @ 25°C.
4.5 MOISTURE RESISTANCE: IP67 (MATED CONDITION).
4.6 MATING CYCLE DURABILITY: 100 CYCLES
4.7 RoHS COMPLIANT

5. MATING PART: AT06-12SX* PLUG
(X=A,B,C,D KEYS * = AVAILABLE MODIFICATIONS)

6. ORIENTATION OF "Amphenol" AND "-P031" TO BE OPTIONAL

7. BORDERS SIGNIFY THAT EACH GROUP OF PINS (PINS 1,11,12 , PINS 2,3,10, PINS 4,8,9 AND PINS 5,6,7) ARE BUSSED TOGETHER WITH A 3 PIN BUSBAR

8. ALL DIMENSIONS ARE FOR REFERENCE USE ONLY.

SEE SHEET 2		REF: DT04-12PA-P031 & DT04-12PB-P031		
PART NUMBER		DESCRIPTION		
QUANTITY	MATERIALS LIST			ITEM
UNLESS OTHERWISE SPECIFIED 1) All dimensions are in metric(mm). 2) Tolerances are as follows: 1 PL DEC ±0.30 Fractions ±1/64 2 PL DEC ±0.15 3 PL DEC ±0.08 3) Note reference = X		SIGNATURES		DATE
DRAWN:		ROOKIE		11APR18
CHECKED:		ORION		11APR18
ENGINEER:				
APPROVAL:		TOMMY		11APR18
MATERIAL SPECIFICATIONS:		CUSTOMER:		
PROCESS SPECIFICATIONS:		THIS DRAWING IS SUPPLIED FOR INFORMATION ONLY. DESIGN FEATURES, SPECIFICATIONS AND PERFORMANCE DATA SHOWN HEREON ARE THE PROPERTY OF THE AMPHENOL CORPORATION. NO RIGHTS OF REPRODUCTION ARE IMPLIED. ALL DIMENSIONS ARE SUBJECT TO NORMAL MANUFACTURING VARIATIONS.		
NEXT ASSY:		SIZE		REVISION
		B C-		A2
		SCALE: NONE		
		DWG NO: AT04-12PX-P031		
		SHEET 1 OF 2		

TITLE: HYPERBUSS AT 12WAY RECP (4)3 PIN BUSBAR GOLD-PLATED
DWG NO: AT04-12PX-P031
REV: A2
SH: 1
OF: 2

REVISIONS					
REV	ECO	DESCRIPTION	DATE	BY	APPR
A1	-	RELEASE NEW DRAWING	11APR18	ROOKIE	TOMMY
A2	-	REVISED DESCRIPTION	12JUN19	JAH	DH

P/N AT04-12PA-P031
KEY-A CONFIGURATION
STANDARD COLOR: GREY

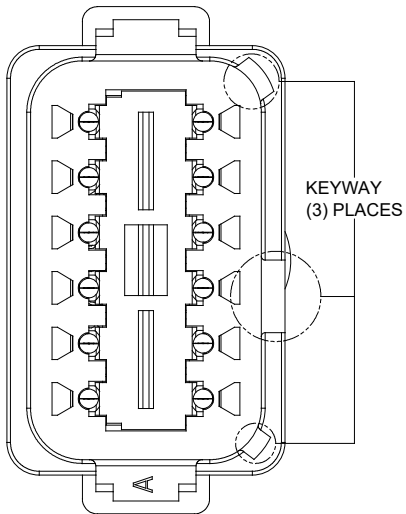

P/N AT04-12PB-P031
KEY-B CONFIGURATION
STANDARD COLOR: BLACK

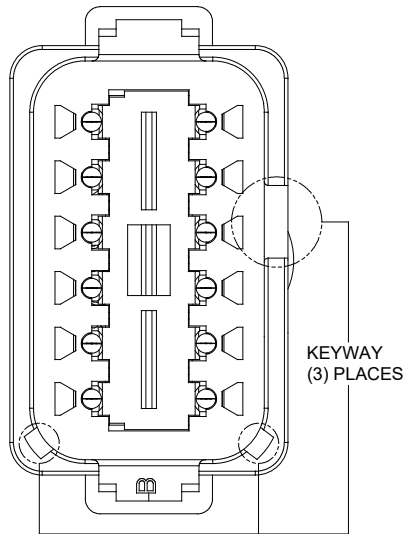

P/N AT04-12PC-P031
KEY-C CONFIGURATION
STANDARD COLOR: GREEN

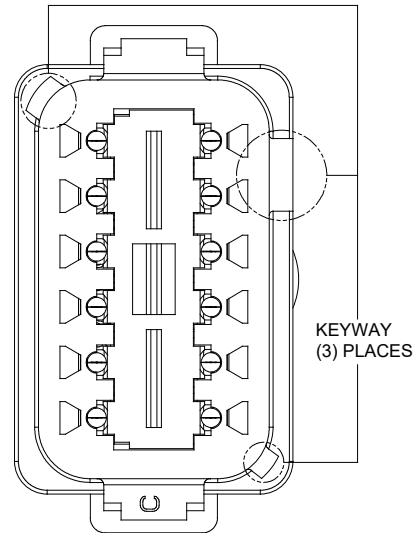

P/N AT04-12PD-P031
KEY-D CONFIGURATION
STANDARD COLOR: BROWN

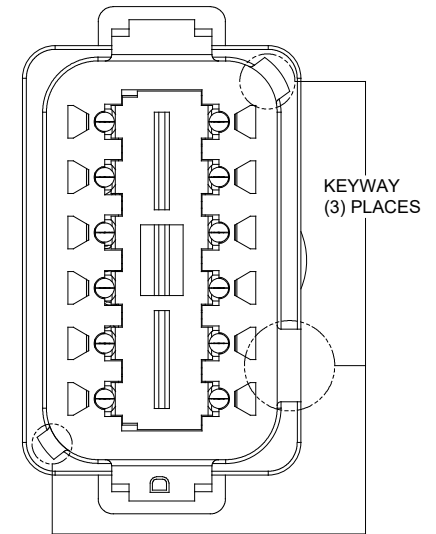

TITLE: HYPERBUSS AT 12WAY RECP (4)3 PIN BUSBAR GOLD-PLATED DWG NO.: AT04-12PX-P031 REV: A2 SH: 2 OF: 2

PART NUMBER		DESCRIPTION		ITEM
QUANTITY		MATERIALS LIST		
UNLESS OTHERWISE SPECIFIED		SIGNATURES		DATE
1) All dimensions are in metric(mm).		DRAWN: ROOKIE		11APR18
2) Tolerances are as follows:		CHECKED: ORION		11APR18
1 PL DEC ±0.30 Fractions ±1/64		ENGINEER:		
2 PL DEC ±0.15 Angles ±1°		APPROVAL: TOMMY		11APR18
3) Note reference =		CUSTOMER:		
MATERIAL SPECIFICATIONS:		THIS DRAWING IS SUPPLIED FOR INFORMATION ONLY. DESIGN FEATURES, SPECIFICATIONS AND PERFORMANCE DATA SHOWN HEREON ARE THE PROPERTY OF THE AMPHENOL CORPORATION. NO RIGHTS OF REPRODUCTION ARE IMPLIED. ALL DIMENSIONS ARE SUBJECT TO NORMAL MANUFACTURING VARIATIONS.		
PROCESS SPECIFICATIONS:		SIZE	TYPE	DWG NO.
NEXT ASSY:		B	C-	AT04-12PX-P031
		SCALE	NONE	REVISION A2
		SHEET 2 OF 2		

Amphenol
Sine Systems - www.amphenol-sine.com
44724 Morley Drive
Clinton Township, MI 48036

HYPERBUSS AT 12WAY RECEPTACLE
(4)3 PIN BUSBAR GOLD-PLATED

X-ON Electronics

Largest Supplier of Electrical and Electronic Components

Click to view similar products for [Automotive Connectors](#) category:

Click to view products by [Amphenol](#) manufacturer:

Other Similar products are found below :

[003-018-000](#) [60403001](#) [60993906-B](#) [M902-2131](#) [M902-2161](#) [72.330.1035.1](#) [73.353.4028.0](#) [F119300-B](#) [F166900](#) [F258300-B](#) [F358300-B](#)
[F407400](#) [F444110](#) [F487000](#) [F509500B-B](#) [827153-1](#) [8N1515-32-24P](#) [9-1326729-8](#) [925474-1](#) [928905-1](#) [964562-4](#) [968782-1](#) [GT17SA-8DS-](#)
[HU](#) [98891-1012](#) [98947-1016](#) [12004475-L](#) [12010290](#) [12010309-B](#) [12015454](#) [12020219-B](#) [12020308](#) [12041318-B](#) [12052225-L](#) [12052466](#)
[12059125](#) [12064869](#) [12004327-B](#) [12010503-B](#) [12015308](#) [12015384](#) [12015909](#) [1-21030-1](#) [12041254](#) [12041318](#) [12047946-B](#) [12047957](#)
[12047957-L](#) [12059473](#) [12066261](#) [12110546](#)