

REVISIONS					
REV	ECO	DESCRIPTION	DATE	BY	APPR
A1	-	RELEASE NUMBER	30/NOV/18	ROOKIE	TOMMY

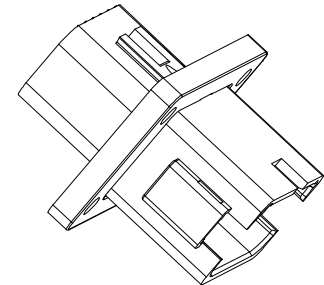
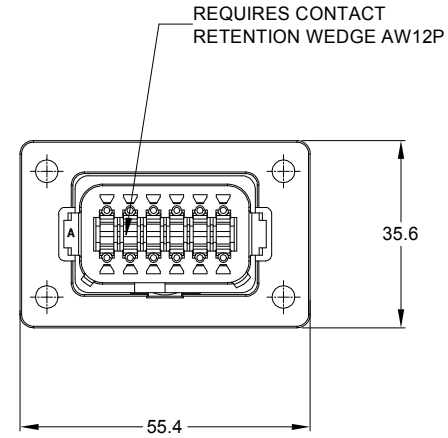
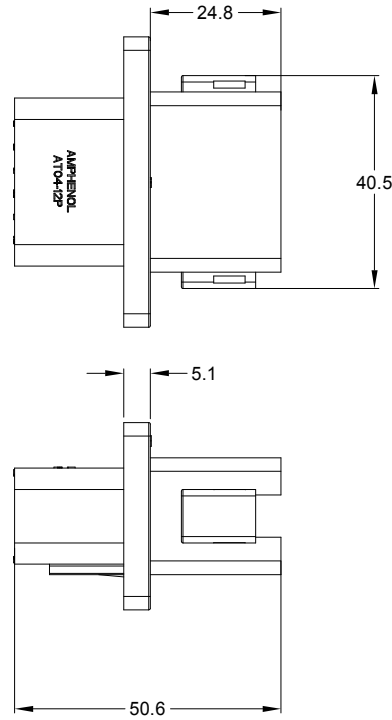
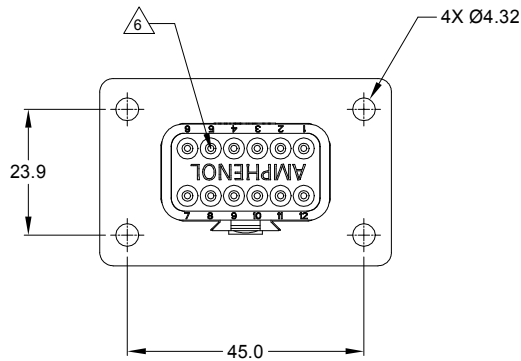

NOTES: UNLESS OTHERWISE SPECIFIED

1. SEE SHEET 2 FOR KEY ARRANGEMENTS AND COLORS.

2. MATERIAL:  
HOUSING: THERMOPLASTIC  
SEAL: SILICONE RUBBER

3. MODIFICATIONS: FLANGE

4. SPECIFICATIONS:  
4.1 CURRENT RATING: 13 AMPS  
4.2 OPERATING TEMPERATURE: -55°C TO +125°C.  
4.3 DIELECTRIC WITHSTANDING VOLTAGE: LESS THAN 2 MILLIAMPS CURRENT LEAKAGE @ 1500 VOLTS AC.  
4.4 INSULATION RESISTANCE: 1000 MEGOHMS MIN @ 25°C.  
4.5 MOISTURE RESISTANCE: IP67 ( MATED CONDITION )  
4.6 MATING CYCLE DURABILITY: 100 CYCLES  
4.7 RoHS COMPLIANT

5. MATING PART: AT06-12SX\* PLUG.  
( X=A,B,C,D KEYS, \* = MODIFICATIONS AND COLORS )

6. ALL DIMENSIONS ARE FOR REFERENCE USE ONLY.

7. CONTACT SIZE AND REAR SEAL WIRE RANGE:

CONTACT SIZE	MIN. INSUL O.D.	MAX. INSUL O.D.	TYPICAL WIRE RANGE
16	2.24 mm (.088 in)	3.68 mm (.145 in)	14 - 20 AWG

SEE SHEET 2		DESCRIPTION		ITEM
QUANTITY	PART NUMBER			
<b>MATERIALS LIST</b>				
<b>UNLESS OTHERWISE SPECIFIED</b> 1) All dimensions are in metric (mm). 2) Tolerances are as follows: 1 PL DEC ±0.30 2 PL DEC ±0.15 3 PL DEC ±0.08 Fractions ±1/64 Angles ±1° 3) Note reference =		<b>SIGNATURES</b> <b>DATE</b> DRAWN: ROOKIE    30/NOV/18 CHECKED: ORON    30/NOV/18 ENGINEER: APPROVAL: TOMMY    30/NOV/18 CUSTOMER:		
MATERIAL SPECIFICATIONS:		 Sine Systems - www.amphenol-sine.com 44724 Morley Drive Clinton Township, MI 48036		
PROCESS SPECIFICATIONS:		12P RECEPTACLE, FLANGE MOUNT, ENHANCE KEY		
NEXT ASSY:		<b>SIZE</b> B C-	<b>DWG NO.</b> AT04-12PX-BL04	<b>REVISION</b> A1
		SCALE: NONE	SHEET 1 OF 3	

TITLE: 12P RECEPTACLE, FLANGE MOUNT, ENHANCE KEY  
 DWG NO.: AT04-12PX-BL04  
 REV: A1  
 SH: 1  
 OF: 3

REVISIONS					
REV	ECO	DESCRIPTION	DATE	BY	APPR
A1	-	RELEASE NUMBER	30/NOV/18	ROOKIE	TOMMY

KEY A CONFIGURATION  
STANDARD COLOR:GREY

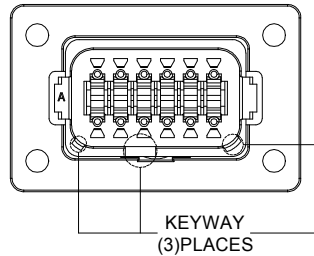
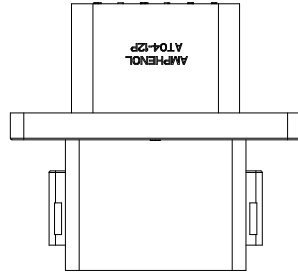

KEY-A CONFIGURATION	
COLOR	PART NUMBER
GREY	AT04-12PA-BL04

KEY B CONFIGURATION  
STANDARD COLOR:BLACK

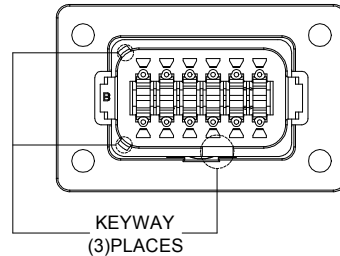
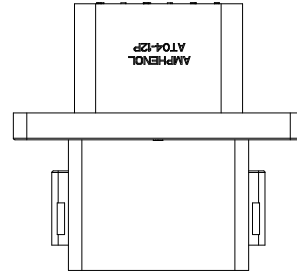

KEY-B CONFIGURATION	
COLOR	PART NUMBER
BLACK	AT04-12PB-BL04

KEY C CONFIGURATION  
STANDARD COLOR:GREEN

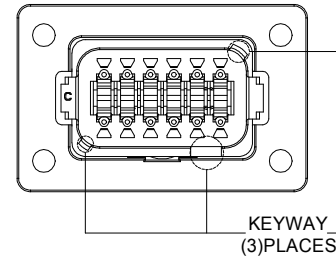
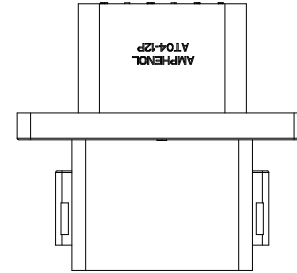

KEY-C CONFIGURATION	
COLOR	PART NUMBER
GREEN	AT04-12PC-BL04

KEY D CONFIGURATION  
STANDARD COLOR:BROWN

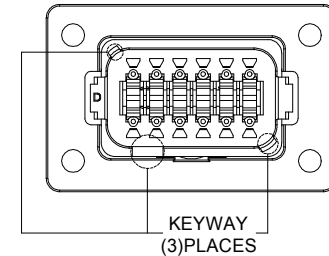
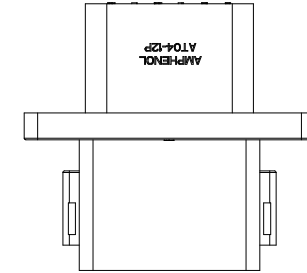

KEY-D CONFIGURATION	
COLOR	PART NUMBER
BROWN	AT04-12PD-BL04

TITLE: 12P RECEPTACLE, FLANGE MOUNT, ENHANCE KEY  
DWG NO.: AT04-12PX-BL04  
REV: A1  
SH: 2  
OF: 3

QUANTITY	SEE SHEET 2 PART NUMBER	DESCRIPTION	ITEM
<b>MATERIALS LIST</b>			
<b>UNLESS OTHERWISE SPECIFIED</b> 1) All dimensions are in metric(mm). 2) Tolerances are as follows: 1 PL DEC $\pm 0.30$ 2 PL DEC $\pm 0.15$ 3 PL DEC $\pm 0.08$ 3) Note reference = $\triangle$		<b>SIGNATURES</b> DRAWN: ROOKIE 30NOV/18 CHECKED: ORION 30NOV/18 ENGINEER: APPROVAL: TOMMY 30NOV/18 CUSTOMER:	<b>DATE</b> 30NOV/18
MATERIAL SPECIFICATIONS:  PROCESS SPECIFICATIONS:  NEXT ASSY:		 Sine Systems - www.amphenol-sine.com 44724 Morley Drive Clinton Township, MI 48036  12P RECEPTACLE, FLANGE MOUNT, ENHANCE KEY	
THIS DRAWING IS SUPPLIED FOR INFORMATION ONLY. DESIGN FEATURES, SPECIFICATIONS AND PERFORMANCE DATA SHOWN HEREON ARE THE PROPERTY OF THE AMPHENOL CORPORATION. NO RIGHTS OF REPRODUCTION ARE IMPLIED. ALL DIMENSIONS ARE SUBJECT TO NORMAL MANUFACTURING VARIATIONS.		<b>SIZE</b> B C-	<b>DWG NO.</b> AT04-12PX-BL04  <b>REVISION</b> A1
SCALE: NONE		SHEET 2 OF 3	

REVISIONS					
REV	ECO	DESCRIPTION	DATE	BY	APPR
A1	-	RELEASE NUMBER	30/NOV/18	ROOKIE	TOMMY

FOR REFERENCE ONLY

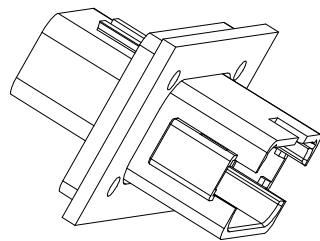

FRONT MOUNT

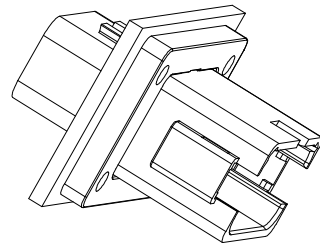

REAR MOUNT

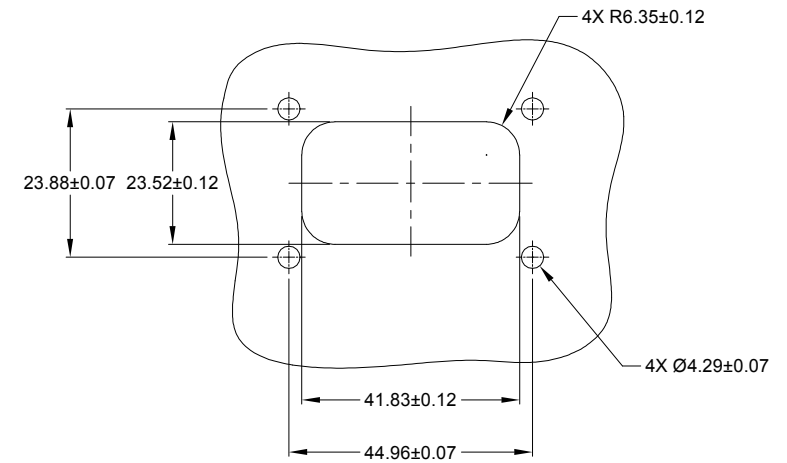

RECOMMENDED CUTOUT  
FRONT AND REAR MOUNT

SEE SHEET 2		
PART NUMBER	DESCRIPTION	ITEM

QUANTITY		PART NUMBER		DESCRIPTION		ITEM
<b>MATERIALS LIST</b>						
<b>UNLESS OTHERWISE SPECIFIED</b> 1) All dimensions are in metric(mm). 2) Tolerances are as follows: 1 PL DEC ±0.30 Fractions ±1/64 2 PL DEC ±0.15 Angles ±1° 3 PL DEC ±0.08 3) Note reference =		<b>SIGNATURES</b> DRAWN: <b>ROOKIE</b> CHECKED: <b>ORION</b> APPROVAL: <b>TOMMY</b>		<b>DATE</b> 30/NOV/18 30/NOV/18 30/NOV/18		 Sine Systems - www.amphenol-sine.com 44724 Morley Drive Clinton Township, MI 48036
MATERIAL SPECIFICATIONS:		CUSTOMER:		12P RECEPTACLE, FLANGE MOUNT, ENHANCE KEY		
PROCESS SPECIFICATIONS:		THIS DRAWING IS SUPPLIED FOR INFORMATION ONLY. DESIGN FEATURES, SPECIFICATIONS AND PERFORMANCE DATA SHOWN HEREON ARE THE PROPERTY OF THE AMPHENOL CORPORATION. NO RIGHTS OF REPRODUCTION ARE IMPLIED. ALL DIMENSIONS ARE SUBJECT TO NORMAL MANUFACTURING VARIATIONS.		SCALE: <b>B C-</b> NONE		DWG NO: <b>AT04-12PX-BL04</b> REVISION <b>A1</b>
NEXT ASSY:				SHEET 3 OF 3		

TITLE: 12P RECEPTACLE, FLANGE MOUNT, ENHANCE KEY  
 DWG NO: AT04-12PX-BL04  
 REV: A1  
 SH: 3  
 OF: 3

## X-ON Electronics

Largest Supplier of Electrical and Electronic Components

*Click to view similar products for [Automotive Connectors](#) category:*

*Click to view products by [Amphenol](#) manufacturer:*

Other Similar products are found below :

[003-018-000](#) [60403001](#) [60993906-B](#) [M902-2131](#) [M902-2161](#) [72.330.1035.1](#) [73.353.4028.0](#) [F119300-B](#) [F166900](#) [F258300-B](#) [F358300-B](#)  
[F407400](#) [F444110](#) [F487000](#) [F509500B-B](#) [827153-1](#) [8N1515-32-24P](#) [9-1326729-8](#) [925474-1](#) [928905-1](#) [964562-4](#) [968782-1](#) [GT17SA-8DS-](#)  
[HU](#) [98891-1012](#) [98947-1016](#) [12004475-L](#) [12010290](#) [12010309-B](#) [12015454](#) [12020219-B](#) [12020308](#) [12041318-B](#) [12052225-L](#) [12052466](#)  
[12059125](#) [12064869](#) [12004327-B](#) [12010503-B](#) [12015308](#) [12015384](#) [12015909](#) [1-21030-1](#) [12041254](#) [12041318](#) [12047946-B](#) [12047957](#)  
[12047957-L](#) [12059473](#) [12066261](#) [12110546](#)