

REVISIONS					
REV	ECO	DESCRIPTION	DATE	BY	APPR
A1	-	RELEASE NEW DRAWING	11APR18	ROOKIE	TOMMY
A2	-	REVISED DESCRIPTION	12JUN19	JAH	DH

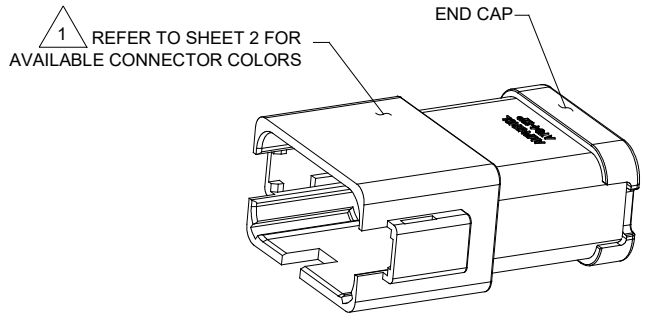
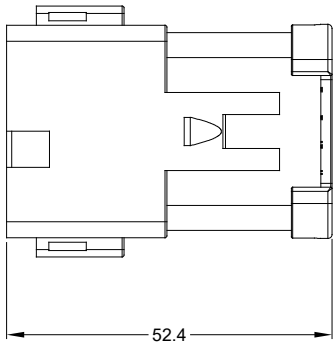
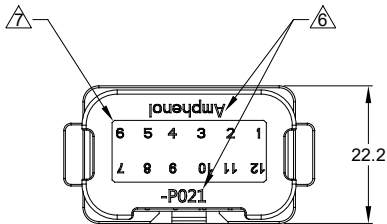
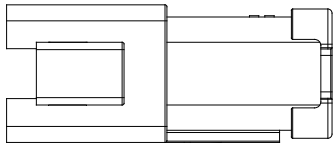
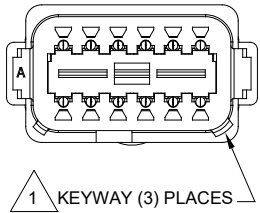
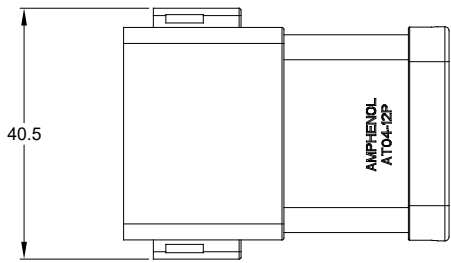

NOTES: UNLESS OTHERWISE SPECIFIED

1 SEE SHEET 2 FOR KEY ARRANGEMENTS AND COLORS.

2. MATERIAL:
HOUSING: THERMOPLASTIC
SEAL: SILICONE RUBBER
CONTACT: COPPER ALLOY

3. MODIFICATIONS: 12 PIN BUSBAR WITH NICKEL PLATED

4. SPECIFICATIONS:
4.1 CURRENT RATING: 78 AMPS MAXIMUM FOR THE 12 PIN BUSBAR
4.2 OPERATING TEMPERATURE: -55°C TO +125°C.
4.3 DIELECTRIC WITHSTANDING VOLTAGE: LESS THAN 2 MILLIAMPS CURRENT LEAKAGE @ 1500 VOLTS AC.
4.4 INSULATION RESISTANCE: 1000 MEGOHM MIN @ 25°C.
4.5 MOISTURE RESISTANCE: IP67 (MATED CONDITION).
4.6 MATING CYCLE DURABILITY: 100 CYCLES
4.7 RoHS COMPLIANT

5. MATING PART: AT06-12SX* PLUG
(X=A,B,C,D KEYS * = AVAILABLE MODIFICATIONS)

6. ORIENTATION OF "Amphenol" AND "-P021" TO BE OPTIONAL

7. ALL DIMENSIONS ARE FOR REFERENCE USE ONLY.

SEE SHEET 2		REF: DT04-12PA-P021 & DT04-12PB-P021			
PART NUMBER		DESCRIPTION		ITEM	
QUANTITY		MATERIALS LIST			
UNLESS OTHERWISE SPECIFIED 1) All dimensions are in metric (mm). 2) Tolerances are as follows: 1 PL DEC ±0.30 Fractions ±1/64 2 PL DEC ±0.15 Angles ±1° 3 PL DEC ±0.08		SIGNATURES		DATE	
3) Note reference = 1		DRAWN: ROOKIE		11APR18	
MATERIAL SPECIFICATIONS:		CHECKED: ORION		11APR18	
PROCESS SPECIFICATIONS:		ENGINEER:			
NEXT ASSY:		APPROVAL: TOMMY		11APR18	
		CUSTOMER:			
		THIS DRAWING IS SUPPLIED FOR INFORMATION ONLY. DESIGN FEATURES, SPECIFICATIONS AND PERFORMANCE DATA SHOWN HEREON ARE THE PROPERTY OF THE AMPHENOL CORPORATION. NO RIGHTS OF REPRODUCTION ARE IMPLIED. ALL DIMENSIONS ARE SUBJECT TO NORMAL MANUFACTURING VARIATIONS.			
		SINE SYSTEMS - www.amphenol-sine.com 44724 Morley Drive Clinton Township, MI 48036			
		HYPERBUSS AT 12WAY RECEPTACLE 12 PIN BUSBAR NICKEL-PLATED			
		SIZE: B C-	DWG NO: AT04-12PX-P021	REVISION: A2	
		SCALE: NONE	SHEET 1 OF 2		

TITLE: HYPERBUSS AT 12WAY RECP 12 PIN BUSBAR N-PLATED
DWG NO: AT04-12PX-P021
REV: A2
SH: 1
OF: 2

REVISIONS					
REV	ECO	DESCRIPTION	DATE	BY	APPR
A1	-	RELEASE NEW DRAWING	11APR18	ROOKIE	TOMMY
A2	-	REVISED DESCRIPTION	12JUN19	JAH	DH

P/N AT04-12PA-P021
KEY-A CONFIGURATION
STANDARD COLOR: GREY

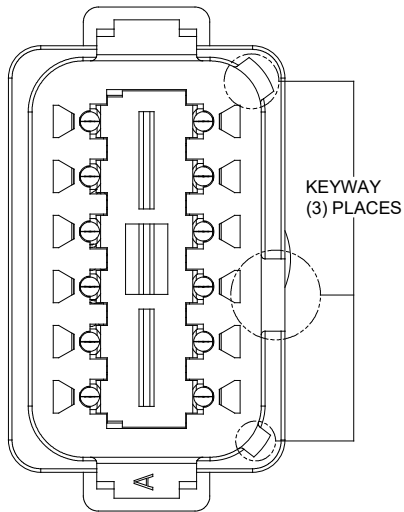

P/N AT04-12PB-P021
KEY-B CONFIGURATION
STANDARD COLOR: BLACK

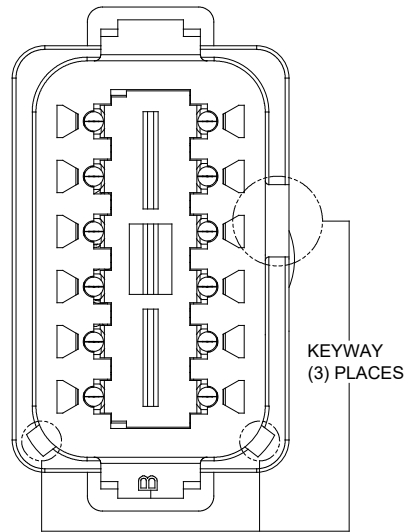

P/N AT04-12PC-P021
KEY-C CONFIGURATION
STANDARD COLOR: GREEN

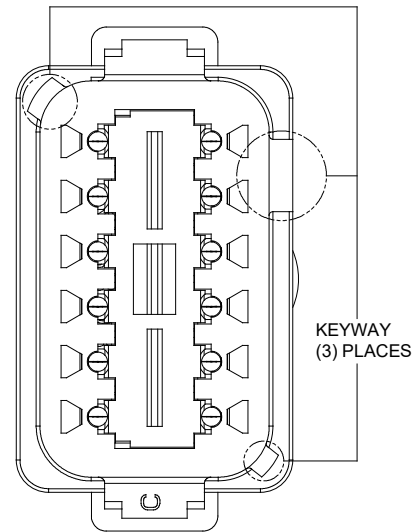

P/N AT04-12PD-P021
KEY-D CONFIGURATION
STANDARD COLOR: BROWN

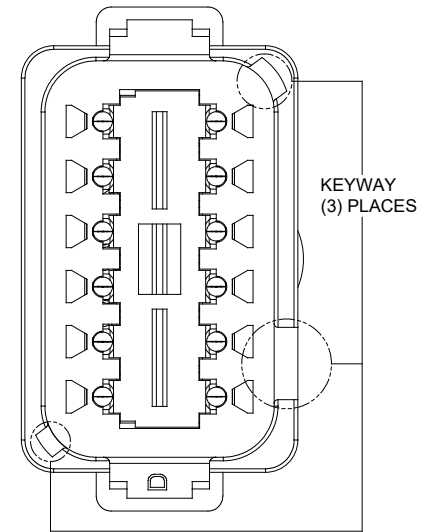

TITLE: HYPERBUSS AT 12WAY RECP 12 PIN BUSBAR NICKEL-PLATED
DWG NO: AT04-12PX-P021
REV: A2
SH: 2
OF: 2

QUANTITY	PART NUMBER	DESCRIPTION	ITEM
MATERIALS LIST			
UNLESS OTHERWISE SPECIFIED 1) All dimensions are in metric (mm). 2) Tolerances are as follows: 1 PL DEC ±0.30 2 PL DEC ±0.15 3 PL DEC ±0.08 3) Note reference =		SIGNATURES DATE DRAWN: ROOKIE 11APR18 CHECKED: ORION 11APR18 ENGINEER: APPROVAL: TOMMY 11APR18 CUSTOMER:	<div style="text-align: center;"> <h1>Amphenol</h1> <p>Sine Systems - www.amphenol-sine.com 44724 Morley Drive Clinton Township, MI 48036</p> </div>
MATERIAL SPECIFICATIONS: PROCESS SPECIFICATIONS: NEXT ASSY:		THIS DRAWING IS SUPPLIED FOR INFORMATION ONLY. DESIGN FEATURES, SPECIFICATIONS AND PERFORMANCE DATA SHOWN HEREON ARE THE PROPERTY OF THE AMPHENOL CORPORATION. NO RIGHTS OF REPRODUCTION ARE IMPLIED. ALL DIMENSIONS ARE SUBJECT TO NORMAL MANUFACTURING VARIATIONS.	SIZE: B C- DWG NO: AT04-12PX-P021 REVISION: A2 SCALE: NONE SHEET 2 OF 2

X-ON Electronics

Largest Supplier of Electrical and Electronic Components

Click to view similar products for [Automotive Connectors](#) category:

Click to view products by [Amphenol](#) manufacturer:

Other Similar products are found below :

[003-018-000](#) [60403001](#) [60993906-B](#) [M902-2131](#) [M902-2161](#) [72.330.1035.1](#) [73.353.4028.0](#) [F119300-B](#) [F166900](#) [F258300-B](#) [F358300-B](#)
[F407400](#) [F444110](#) [F487000](#) [F509500B-B](#) [827153-1](#) [8N1515-32-24P](#) [9-1326729-8](#) [925474-1](#) [928905-1](#) [964562-4](#) [968782-1](#) [GT17SA-8DS-](#)
[HU](#) [98891-1012](#) [98947-1016](#) [12004475-L](#) [12010290](#) [12010309-B](#) [12015454](#) [12020219-B](#) [12020308](#) [12041318-B](#) [12052225-L](#) [12052466](#)
[12059125](#) [12064869](#) [12004327-B](#) [12010503-B](#) [12015308](#) [12015384](#) [12015909](#) [1-21030-1](#) [12041254](#) [12041318](#) [12047946-B](#) [12047957](#)
[12047957-L](#) [12059473](#) [12066261](#) [12110546](#)