

1 KEYWAY (3) PLACES

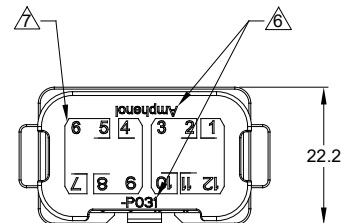

1 REFER TO SHEET 2 FOR AVAILABLE CONNECTOR COLORS

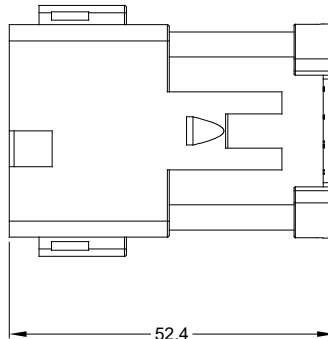
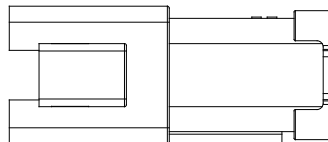
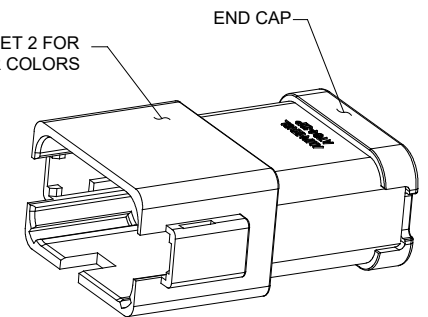

REVISIONS					
REV	ECO	DESCRIPTION	DATE	BY	APPR
A1	-	RELEASE NEW DRAWING	11APR18	ROOKIE	TOMMY
A2	-	REVISED DESCRIPTION	12JUN19	JAH	DH

NOTES: UNLESS OTHERWISE SPECIFIED

1 SEE SHEET 2 FOR KEY ARRANGEMENTS AND COLORS.

2. MATERIAL:
HOUSING: THERMOPLASTIC
SEAL: SILICONE RUBBER
CONTACT: COPPER ALLOY

3. MODIFICATIONS: 4 PIECES OF 3 PIN BUSBAR WITH GOLD PLATED

4. SPECIFICATIONS:
4.1 CURRENT RATING: 13 AMPS MAXIMUM FOR THE 3 PIN BUSBAR
4.2 OPERATING TEMPERATURE: -55°C TO +125°C.
4.3 DIELECTRIC WITHSTANDING VOLTAGE: LESS THAN 2 MILLIAMPS CURRENT LEAKAGE @ 1500 VOLTS AC.
4.4 INSULATION RESISTANCE: 1000 MEGOHM MIN @ 25°C.
4.5 MOISTURE RESISTANCE: IP67 (MATED CONDITION).
4.6 MATING CYCLE DURABILITY: 100 CYCLES
4.7 RoHS COMPLIANT

5. MATING PART: AT06-12SX* PLUG
(X=A,B,C,D KEYS * = AVAILABLE MODIFICATIONS)

6. ORIENTATION OF "Amphenol" AND "-P031" TO BE OPTIONAL

7. BORDERS SIGNIFY THAT EACH GROUP OF PINS (PINS 1,11,12 , PINS 2,3,10, PINS 4,8,9 AND PINS 5,6,7) ARE BUSSED TOGETHER WITH A 3 PIN BUSBAR

8. ALL DIMENSIONS ARE FOR REFERENCE USE ONLY.

SEE SHEET 2		REF: DT04-12PA-P031 & DT04-12PB-P031		
PART NUMBER		DESCRIPTION		
QUANTITY	MATERIALS LIST			ITEM
UNLESS OTHERWISE SPECIFIED 1) All dimensions are in metric(mm). 2) Tolerances are as follows: 1 PL DEC ±0.30 Fractions ±1/64 2 PL DEC ±0.15 3 PL DEC ±0.08 3) Note reference = 		SIGNATURES		DATE
DRAWN:		ROOKIE		11APR18
CHECKED:		ORION		11APR18
ENGINEER:				
APPROVAL:		TOMMY		11APR18
MATERIAL SPECIFICATIONS:		CUSTOMER:		
PROCESS SPECIFICATIONS:		THIS DRAWING IS SUPPLIED FOR INFORMATION ONLY. DESIGN FEATURES, SPECIFICATIONS AND PERFORMANCE DATA SHOWN HEREON ARE THE PROPERTY OF THE AMPHENOL CORPORATION. NO RIGHTS OF REPRODUCTION ARE IMPLIED. ALL DIMENSIONS ARE SUBJECT TO NORMAL MANUFACTURING VARIATIONS.		
NEXT ASSY:		SIZE		REVISION
		B C-		A2
		SCALE: NONE		
		DWG NO: AT04-12PX-P031		
		SHEET 1 OF 2		

TITLE: HYPERBUSS AT 12WAY RECP (4)3 PIN BUSBAR GOLD-PLATED

DWG NO:

AT04-12PX-P031

REV: A2

SH: 1

OF: 2

REVISIONS					
REV	ECO	DESCRIPTION	DATE	BY	APPR
A1	-	RELEASE NEW DRAWING	11APR18	ROOKIE	TOMMY
A2	-	REVISED DESCRIPTION	12JUN19	JAH	DH

P/N AT04-12PA-P031
KEY-A CONFIGURATION
STANDARD COLOR: GREY

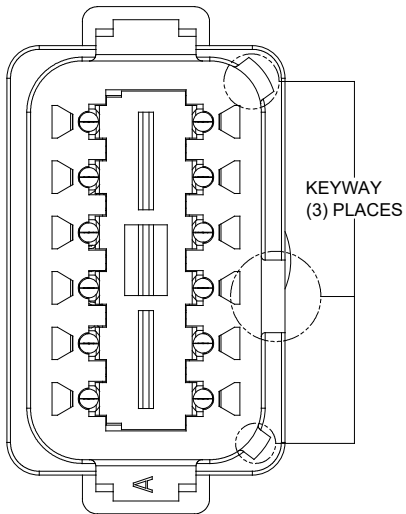

P/N AT04-12PB-P031
KEY-B CONFIGURATION
STANDARD COLOR: BLACK

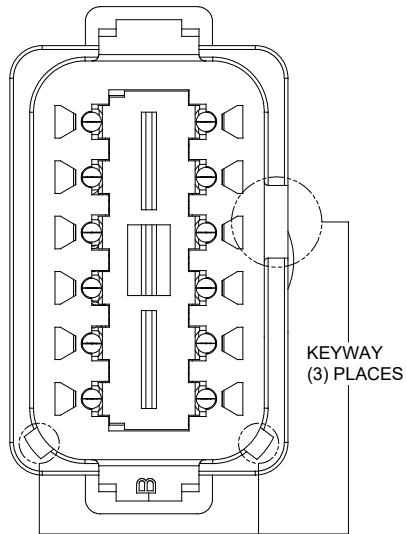

P/N AT04-12PC-P031
KEY-C CONFIGURATION
STANDARD COLOR: GREEN

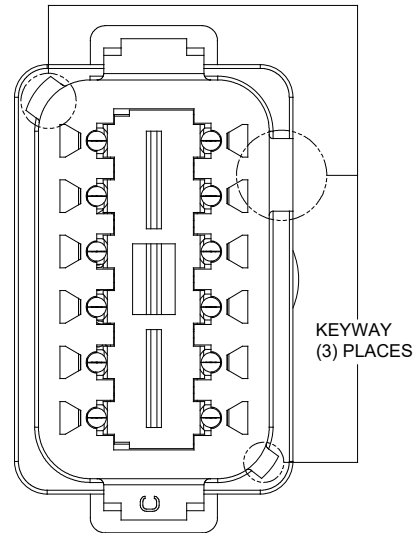

P/N AT04-12PD-P031
KEY-D CONFIGURATION
STANDARD COLOR: BROWN

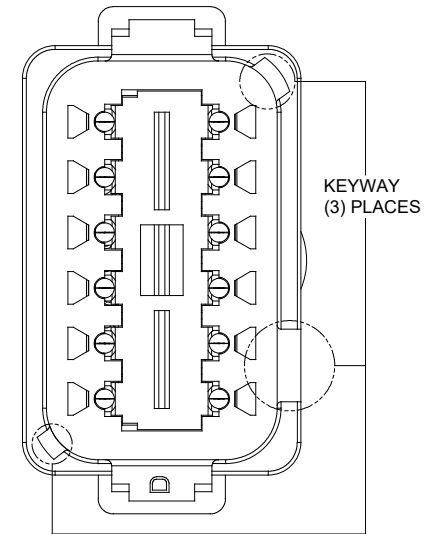

TITLE: HYPERBUSS AT 12WAY RECP (4)3 PIN BUSBAR GOLD-PLATED DWG NO.: AT04-12PX-P031 REV: A2 SH: 2 OF: 2

QUANTITY	PART NUMBER	DESCRIPTION	ITEM												
MATERIALS LIST															
<small>UNLESS OTHERWISE SPECIFIED</small> 1) All dimensions are in metric(mm). 2) Tolerances are as follows: 1 PL DEC ±0.30 Fractions ±1/64 2 PL DEC ±0.15 Angles ±1° 3 PL DEC ±0.08 3) Note reference =		<table border="1"> <thead> <tr> <th>SIGNATURES</th> <th>DATE</th> </tr> </thead> <tbody> <tr> <td>DRAWN: ROOKIE</td> <td>11APR18</td> </tr> <tr> <td>CHECKED: ORION</td> <td>11APR18</td> </tr> <tr> <td>ENGINEER:</td> <td></td> </tr> <tr> <td>APPROVAL: TOMMY</td> <td>11APR18</td> </tr> <tr> <td>CUSTOMER:</td> <td></td> </tr> </tbody> </table>	SIGNATURES	DATE	DRAWN: ROOKIE	11APR18	CHECKED: ORION	11APR18	ENGINEER:		APPROVAL: TOMMY	11APR18	CUSTOMER:		<p style="text-align: center;">Amphenol</p> <p style="text-align: center;">Sine Systems - www.amphenol-sine.com 44724 Morley Drive Clinton Township, MI 48036</p>
SIGNATURES	DATE														
DRAWN: ROOKIE	11APR18														
CHECKED: ORION	11APR18														
ENGINEER:															
APPROVAL: TOMMY	11APR18														
CUSTOMER:															
<small>MATERIAL SPECIFICATIONS:</small> <small>PROCESS SPECIFICATIONS:</small> <small>NEXT ASSY:</small>		<small>THIS DRAWING IS SUPPLIED FOR INFORMATION ONLY. DESIGN FEATURES, SPECIFICATIONS AND PERFORMANCE DATA SHOWN HEREON ARE THE PROPERTY OF THE AMPHENOL CORPORATION. NO RIGHTS OF REPRODUCTION ARE IMPLIED. ALL DIMENSIONS ARE SUBJECT TO NORMAL MANUFACTURING VARIATIONS.</small>	<table border="1"> <thead> <tr> <th>SIZE</th> <th>TYPE</th> <th>DWG NO.</th> <th>REVISION</th> </tr> </thead> <tbody> <tr> <td>B</td> <td>C-</td> <td>AT04-12PX-P031</td> <td>A2</td> </tr> <tr> <td colspan="3">SCALE: NONE</td> <td>SHEET 2 OF 2</td> </tr> </tbody> </table>	SIZE	TYPE	DWG NO.	REVISION	B	C-	AT04-12PX-P031	A2	SCALE: NONE			SHEET 2 OF 2
SIZE	TYPE	DWG NO.	REVISION												
B	C-	AT04-12PX-P031	A2												
SCALE: NONE			SHEET 2 OF 2												

X-ON Electronics

Largest Supplier of Electrical and Electronic Components

Click to view similar products for [Automotive Connectors](#) category:

Click to view products by [Amphenol](#) manufacturer:

Other Similar products are found below :

[003-018-000](#) [60403001](#) [60993906-B](#) [M902-2131](#) [M902-2161](#) [72.330.1035.1](#) [73.353.4028.0](#) [F119300-B](#) [F166900](#) [F258300-B](#) [F358300-B](#)
[F407400](#) [F444110](#) [F487000](#) [F509500B-B](#) [827153-1](#) [8N1515-32-24P](#) [9-1326729-8](#) [925474-1](#) [928905-1](#) [964562-4](#) [968782-1](#) [GT17SA-8DS-](#)
[HU](#) [98891-1012](#) [98947-1016](#) [12004475-L](#) [12010290](#) [12010309-B](#) [12015454](#) [12020219-B](#) [12020308](#) [12041318-B](#) [12052225-L](#) [12052466](#)
[12059125](#) [12064869](#) [12004327-B](#) [12010503-B](#) [12015308](#) [12015384](#) [12015909](#) [1-21030-1](#) [12041254](#) [12041318](#) [12047946-B](#) [12047957](#)
[12047957-L](#) [12059473](#) [12066261](#) [12110546](#)