

REVISIONS					
REV	ECO	DESCRIPTION	DATE	BY	APPR
A1	-	RELEASE NUMBER	30/NOV/18	BROOK	TOMMY

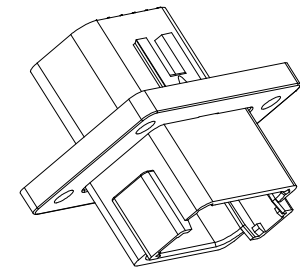
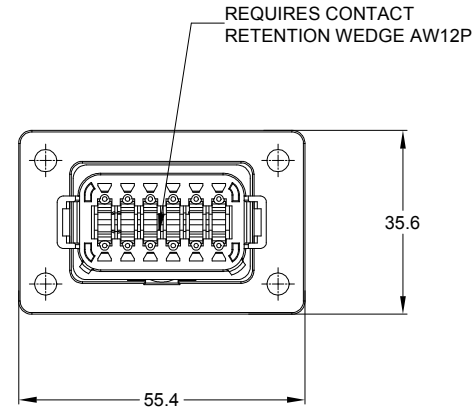
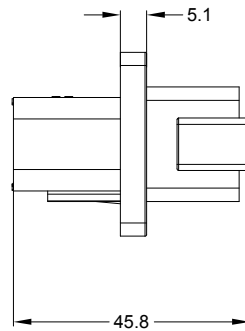
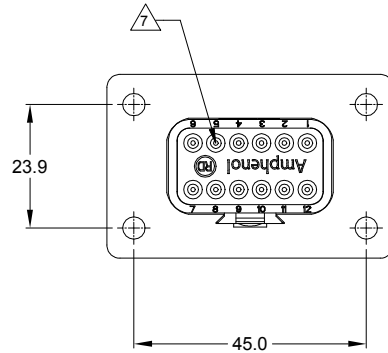
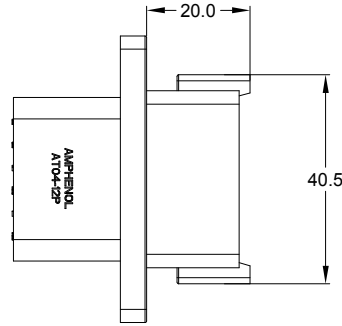

NOTES: UNLESS OTHERWISE SPECIFIED

1. SEE SHEET 2 FOR KEY ARRANGEMENTS AND COLORS.

2. MATERIAL:
HOUSING: THERMOPLASTIC
SEAL: SILICONE RUBBER

3. MODIFICATIONS: FLANGE, REDUCED DIA. WIRE SEAL

4. SPECIFICATIONS:
4.1 CURRENT RATING: 13 AMPS
4.2 OPERATING TEMPERATURE: -55°C TO +125°C.
4.3 DIELECTRIC WITHSTANDING VOLTAGE: LESS THAN 2 MILLIAMPS CURRENT LEAKAGE @ 1500 VOLTS AC.
4.4 INSULATION RESISTANCE: 1000 MEGOHMS MIN @ 25°C.
4.5 MOISTURE RESISTANCE: IP67 (MATED CONDITION)
4.6 MATING CYCLE DURABILITY: 100 CYCLES
4.7 RoHS COMPLIANT

5. MATING PART: AT06-12SX* PLUG.
(X=A,B,C,D KEYS, * = MODIFICATIONS AND COLORS)

6. ALL DIMENSIONS ARE FOR REFERENCE USE ONLY.

7. CONTACT SIZE AND REAR SEAL WIRE RANGE:

CONTACT SIZE	MIN. INSUL O.D.	MAX. INSUL O.D.	TYPICAL WIRE RANGE
16	1.35 mm (.053 in)	3.05 mm (.120 in)	16 - 20 AWG

SEE SHEET 2		DESCRIPTION		ITEM
PART NUMBER		DESCRIPTION		ITEM
QUANTITY	MATERIALS LIST			
UNLESS OTHERWISE SPECIFIED: 1) All dimensions are in metric (mm). 2) Tolerances are as follows: 1 PL DEC ±0.30 Fractions ±1/64 2 PL DEC ±0.15 Angles ±1° 3 PL DEC ±0.08		SIGNATURES		DATE
DRAWN: BROOK		30/NOV/18		
CHECKED: ORION		30/NOV/18		
ENGINEER:				
APPROVAL: TOMMY		30/NOV/18		
MATERIAL SPECIFICATIONS:		CUSTOMER:		
PROCESS SPECIFICATIONS:		THIS DRAWING IS SUPPLIED FOR INFORMATION ONLY. DESIGN FEATURES, SPECIFICATIONS AND PERFORMANCE DATA SHOWN HEREON ARE THE PROPERTY OF THE AMPHENOL CORPORATION. NO RIGHTS OF REPRODUCTION ARE IMPLIED. ALL DIMENSIONS ARE SUBJECT TO NORMAL MANUFACTURING VARIATIONS.		
NEXT ASSY:		SCALE: NONE		
		SIZE B C-		DWG NO: AT04-12PX-CL03
		REVISION A1		SHEET 1 OF 3

TITLE: 12P RECEPTACLE, FLANGE MOUNT, RD
DWG NO.: AT04-12PX-CL03
REV: A1
SH: 1
OF: 3

REVISIONS					
REV	ECO	DESCRIPTION	DATE	BY	APPR
A1	-	RELEASE NUMBER	30/NOV/18	BROOK	TOMMY

KEY A CONFIGURATION
STANDARD COLOR:GREY

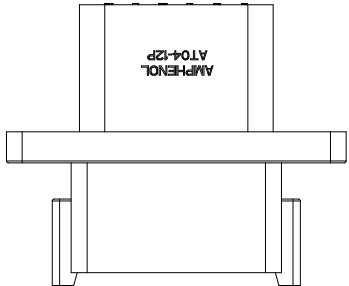

KEY B CONFIGURATION
STANDARD COLOR:BLACK

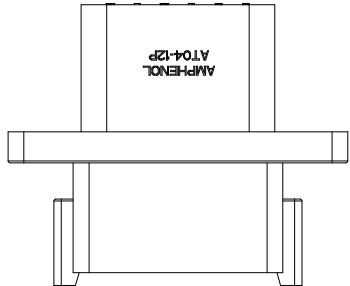

KEY C CONFIGURATION
STANDARD COLOR:GREEN

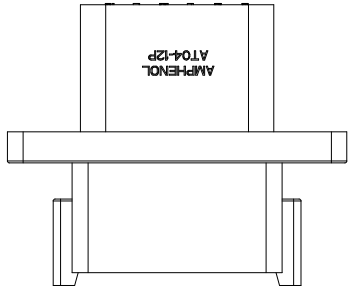

KEY D CONFIGURATION
STANDARD COLOR:BROWN

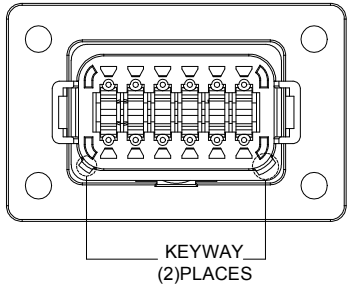
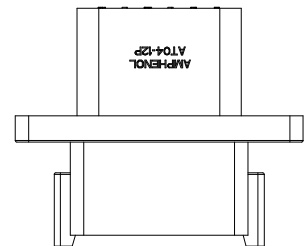

KEY-A CONFIGURATION	
COLOR	PART NUMBER
GREY	AT04-12PA-CL03

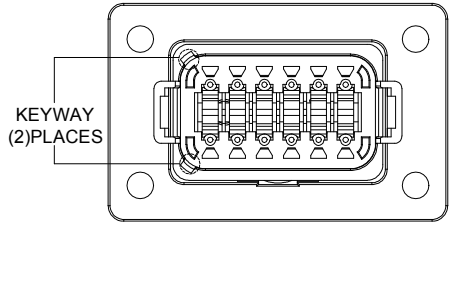

KEY-B CONFIGURATION	
COLOR	PART NUMBER
BLACK	AT04-12PB-CL03

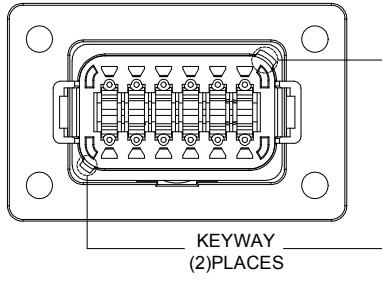

KEY-C CONFIGURATION	
COLOR	PART NUMBER
GREEN	AT04-12PC-CL03

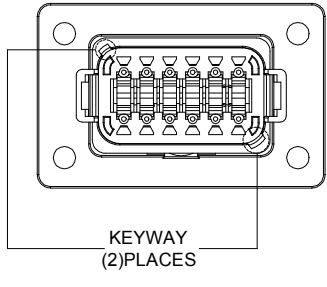

KEY-D CONFIGURATION	
COLOR	PART NUMBER
BROWN	AT04-12PD-CL03

SEE SHEET 2		DESCRIPTION		ITEM
PART NUMBER				
QUANTITY MATERIALS LIST				
UNLESS OTHERWISE SPECIFIED 1) All dimensions are in metric(mm). 2) Tolerances are as follows: 1 PL DEC ±0.30 Fractions ±1/64 2 PL DEC ±0.15 Angles ±1° 3 PL DEC ±0.08 3) Note reference =		SIGNATURES DRAWN: BROOK 30/NOV/18 CHECKED: ORION 30/NOV/18 APPROVAL: TOMMY 30/NOV/18 CUSTOMER:		 Sine Systems - www.amphenol-sine.com 44724 Morley Drive Clinton Township, MI 48036
MATERIAL SPECIFICATIONS: PROCESS SPECIFICATIONS: NEXT ASSY:		THIS DRAWING IS SUPPLIED FOR INFORMATION ONLY. DESIGN FEATURES, SPECIFICATIONS AND PERFORMANCE DATA SHOWN HEREON ARE THE PROPERTY OF THE AMPHENOL CORPORATION. NO RIGHTS OF REPRODUCTION ARE IMPLIED. ALL DIMENSIONS ARE SUBJECT TO NORMAL MANUFACTURING VARIATIONS.		
		SIZE B C- SCALE NONE	TYPE DWG NO: AT04-12PX-CL03	REVISION A1 SHEET 2 OF 3

TITLE: 12P RECEPTACLE, FLANGE MOUNT, RD
 DWG NO.: AT04-12PX-CL03
 REV: A1
 SH: 2
 OF: 3

REVISIONS					
REV	ECO	DESCRIPTION	DATE	BY	APPR
A1	-	RELEASE NUMBER	30/NOV/18	BROOK	TOMMY

FOR REFERENCE ONLY

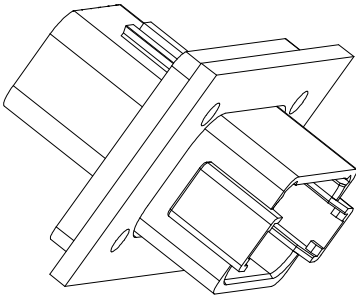

FRONT MOUNT

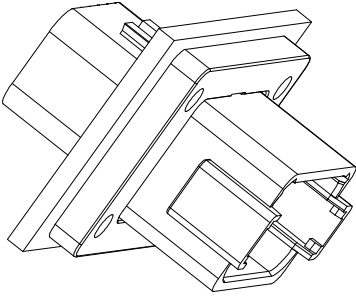

REAR MOUNT

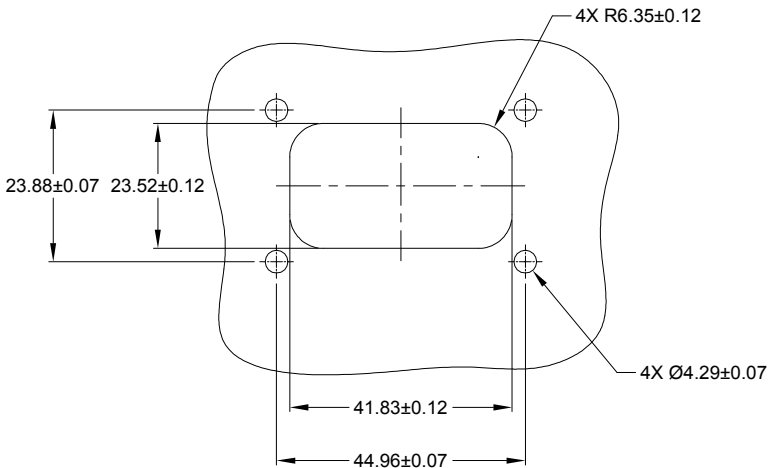

RECOMMENDED CUTOUT
FRONT AND REAR MOUNT

TITLE: 12P RECEPTACLE, FLANGE MOUNT, RD
DWG NO.: AT04-12PX-CL03
REV/A1
SH: 3
OF: 3

SEE SHEET 2		DESCRIPTION		ITEM
PART NUMBER				
QUANTITY	MATERIALS LIST			
UNLESS OTHERWISE SPECIFIED 1) All dimensions are in metric (mm). 2) Tolerances are as follows: 1 PL DEC ±0.30 2 PL DEC ±0.15 3 PL DEC ±0.08 Fractions ±1/64 Angles ±1° 3) Note reference =		SIGNATURES DRAWN: BROOK CHECKED: ORION ENGINEER: APPROVAL: TOMMY	DATE 30/NOV/18 30/NOV/18 30/NOV/18	 Sine Systems - www.amphenol-sine.com 44724 Morley Drive Clinton Township, MI 48036
MATERIAL SPECIFICATIONS:	CUSTOMER:			
PROCESS SPECIFICATIONS:	THIS DRAWING IS SUPPLIED FOR INFORMATION ONLY. DESIGN FEATURES, SPECIFICATIONS AND PERFORMANCE DATA SHOWN HEREON ARE THE PROPERTY OF THE AMPHENOL CORPORATION. NO RIGHTS OF REPRODUCTION ARE IMPLIED. ALL DIMENSIONS ARE SUBJECT TO NORMAL MANUFACTURING VARIATIONS.			
NEXT ASSY:	SIZE B C-	TYPE NONE	DWG NO.: AT04-12PX-CL03	REVISION A1
			SHEET 3	OF 3

X-ON Electronics

Largest Supplier of Electrical and Electronic Components

Click to view similar products for [Automotive Connectors](#) category:

Click to view products by [Amphenol](#) manufacturer:

Other Similar products are found below :

[003-018-000](#) [60403001](#) [60993906-B](#) [M902-2131](#) [M902-2161](#) [72.330.1035.1](#) [73.353.4028.0](#) [F119300-B](#) [F166900](#) [F258300-B](#) [F358300-B](#)
[F407400](#) [F444110](#) [F487000](#) [F509500B-B](#) [827153-1](#) [8N1515-32-24P](#) [9-1326729-8](#) [925474-1](#) [928905-1](#) [964562-4](#) [968782-1](#) [GT17SA-8DS-](#)
[HU](#) [98891-1012](#) [98947-1016](#) [12004475-L](#) [12010290](#) [12010309-B](#) [12015454](#) [12020219-B](#) [12020308](#) [12041318-B](#) [12052225-L](#) [12052466](#)
[12059125](#) [12064869](#) [12004327-B](#) [12010503-B](#) [12015308](#) [12015384](#) [12015909](#) [1-21030-1](#) [12041254](#) [12041318](#) [12047946-B](#) [12047957](#)
[12047957-L](#) [12059473](#) [12066261](#) [12110546](#)