

REVISIONS					
REV	ECO	DESCRIPTION	DATE	BY	APPR
A1	-	RELEASE NUMBER	30/NOV/18	ROOKIE	TOMMY

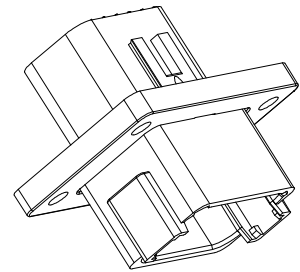
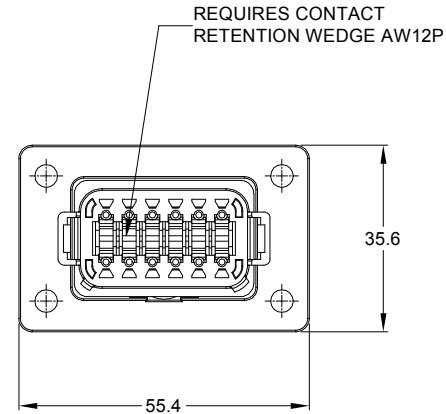
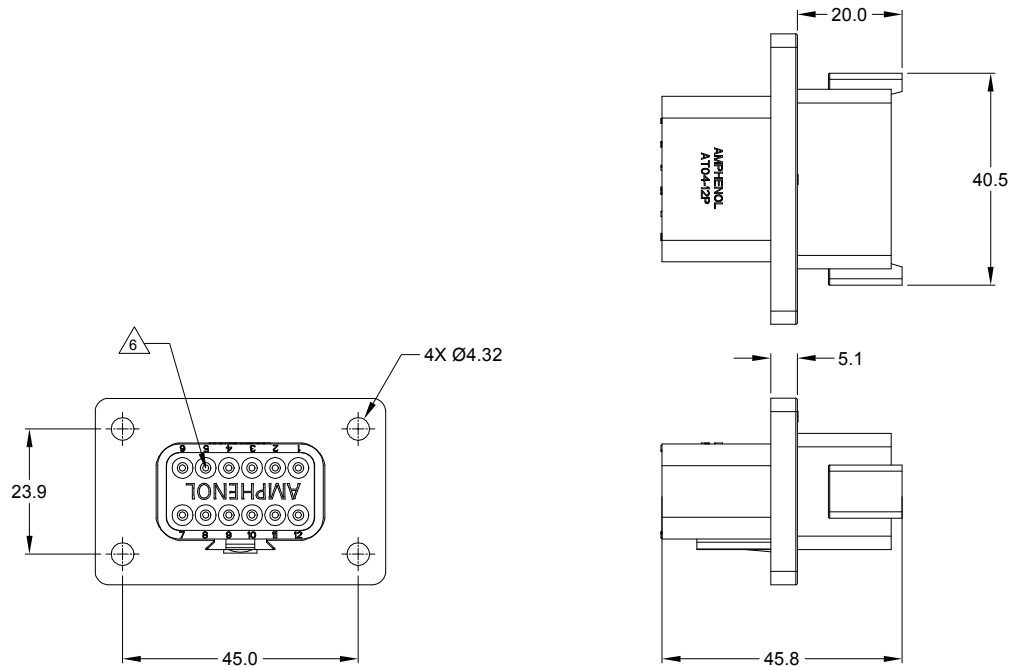

NOTES: UNLESS OTHERWISE SPECIFIED

1. SEE SHEET 2 FOR KEY ARRANGEMENTS AND COLORS.

2. MATERIAL:  
HOUSING: THERMOPLASTIC  
SEAL: SILICONE RUBBER

3. MODIFICATIONS: FLANGE

4. SPECIFICATIONS:  
4.1 CURRENT RATING: 13 AMPS  
4.2 OPERATING TEMPERATURE: -55°C TO +125°C.  
4.3 DIELECTRIC WITHSTANDING VOLTAGE: LESS THAN 2 MILLIAMPS CURRENT LEAKAGE @ 1500 VOLTS AC.  
4.4 INSULATION RESISTANCE: 1000 MEGOHMS MIN @ 25°C.  
4.5 MOISTURE RESISTANCE: IP67 ( MATED CONDITION )  
4.6 MATING CYCLE DURABILITY: 100 CYCLES  
4.7 RoHS COMPLIANT

7. CONTACT SIZE AND REAR SEAL WIRE RANGE:

CONTACT SIZE	MIN. INSUL O.D.	MAX. INSUL O.D.	TYPICAL WIRE RANGE
16	2.24 mm (.088 in)	3.68 mm (.145 in)	14 - 20 AWG

5. MATING PART: AT06-12SX\* PLUG.  
( X=A,B,C,D KEYS, \* = MODIFICATIONS AND COLORS )

6. ALL DIMENSIONS ARE FOR REFERENCE USE ONLY.

QUANTITY	SEE SHEET 2 PART NUMBER	DESCRIPTION	ITEM
			3
MATERIALS LIST			
<b>UNLESS OTHERWISE SPECIFIED</b> 1) All dimensions are in metric (mm). 2) Tolerances are as follows: 1 PL DEC ±0.30 Fractions ±1/64 2 PL DEC ±0.15 Angles ±1° 3 PL DEC ±0.08 3) Note reference =		<b>SIGNATURES</b> DRAWN: ROOKIE 30/NOV/18 CHECKED: ORION 30/NOV/18 ENGINEER: APPROVAL: TOMMY 30/NOV/18 CUSTOMER:	<b>DATE</b> 30/NOV/18 30/NOV/18 30/NOV/18
MATERIAL SPECIFICATIONS:		<b>Amphenol</b> Sine Systems - www.amphenol-sine.com 44724 Morley Drive Clinton Township, MI 48036	
PROCESS SPECIFICATIONS:		12P RECEPTACLE, FLANGE MOUNT	
NEXT ASSY:		THIS DRAWING IS SUPPLIED FOR INFORMATION ONLY. DESIGN FEATURES, SPECIFICATIONS AND PERFORMANCE DATA SHOWN HEREON ARE THE PROPERTY OF THE AMPHENOL CORPORATION. NO RIGHTS OF REPRODUCTION ARE IMPLIED. ALL DIMENSIONS ARE SUBJECT TO NORMAL MANUFACTURING VARIATIONS.	SHEET 1 OF 3
		<b>SIZE</b> B C-	<b>DWG NO.</b> AT04-12PX-L012 <b>REVISION</b> A1
		<b>SCALE:</b> NONE	

TITLE: 12P RECEPTACLE, FLANGE MOUNT  
DWG NO: AT04-12PX-L012  
REV: A1  
SH: 1  
OF: 3

REVISIONS					
REV	ECO	DESCRIPTION	DATE	BY	APPR
A1	-	RELEASE NUMBER	30/NOV/18	ROOKIE	TOMMY

KEY A CONFIGURATION  
STANDARD COLOR:GREY

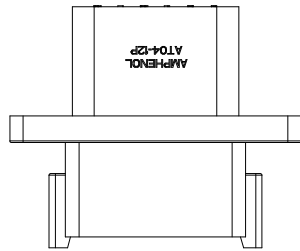

KEY B CONFIGURATION  
STANDARD COLOR:BLACK

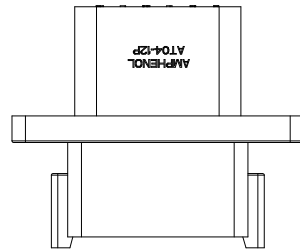

KEY C CONFIGURATION  
STANDARD COLOR:GREEN

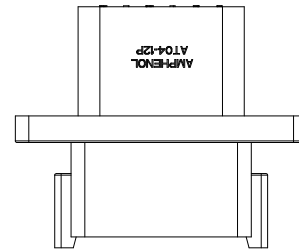

KEY D CONFIGURATION  
STANDARD COLOR:BROWN

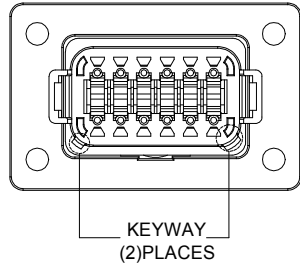
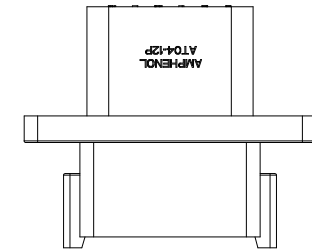

KEYWAY  
(2)PLACES

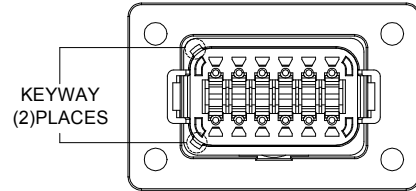

KEYWAY  
(2)PLACES

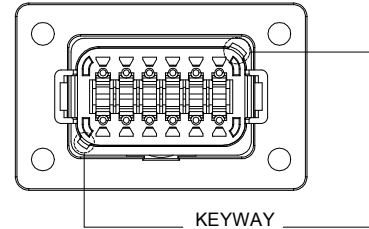

KEYWAY  
(2)PLACES

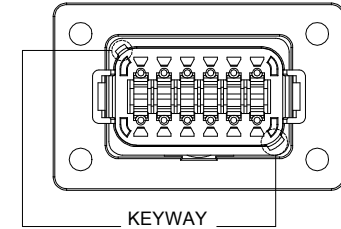

KEYWAY  
(2)PLACES

KEY-A CONFIGURATION	
COLOR	PART NUMBER
GREY	AT04-12PA-L012

KEY-B CONFIGURATION	
COLOR	PART NUMBER
BLACK	AT04-12PB-L012

KEY-C CONFIGURATION	
COLOR	PART NUMBER
GREEN	AT04-12PC-L012

KEY-D CONFIGURATION	
COLOR	PART NUMBER
BROWN	AT04-12PD-L012

SEE SHEET 2	DESCRIPTION	ITEM
PART NUMBER		

MATERIALS LIST			SIGNATURES		DATE
QUANTITY			DRAWN: <b>ROOKIE</b>		<b>30NOV/18</b>
<b>UNLESS OTHERWISE SPECIFIED</b> 1) All dimensions are in metric(mm). 2) Tolerances are as follows: 1 PL DEC ±0.30 2 PL DEC ±0.15 3 PL DEC ±0.08 Fractions ±1/64 Angles ±1° 3) Note reference =			CHECKED: <b>ORION</b>		<b>30NOV/18</b>
MATERIAL SPECIFICATIONS:			ENGINEER:		
PROCESS SPECIFICATIONS:			APPROVAL: <b>TOMMY</b>		<b>30NOV/18</b>
NEXT ASSY:			CUSTOMER:		
THIS DRAWING IS SUPPLIED FOR INFORMATION ONLY. DESIGN FEATURES, SPECIFICATIONS AND PERFORMANCE DATA SHOWN HEREON ARE THE PROPERTY OF THE AMPHENOL CORPORATION. NO RIGHTS OF REPRODUCTION ARE IMPLIED. ALL DIMENSIONS ARE SUBJECT TO NORMAL MANUFACTURING VARIATIONS.			<b>Amphenol</b> Sine Systems - www.amphenol-sine.com 44724 Morley Drive Clinton Township, MI 48036 12P RECEPTACLE, FLANGE MOUNT		
SIZE	TYPE	DWG NO.	REVISION		
<b>B C-</b>		<b>AT04-12PX-L012</b>	<b>A1</b>		
SCALE:	NONE		SHEET	2	OF 3

TITLE: 12P RECEPTACLE FLANGE MOUNT  
DWG NO: AT04-12PX-L012  
REV: A1  
SH: 2  
OF: 3

REVISIONS					
REV	ECO	DESCRIPTION	DATE	BY	APPR
A1	-	RELEASE NUMBER	30/NOV/18	ROOKIE	TOMMY

FOR REFERENCE ONLY

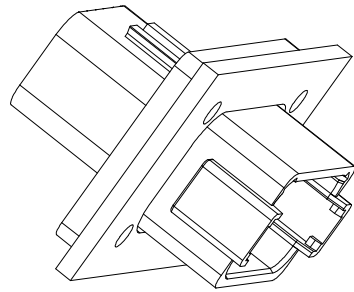

FRONT MOUNT

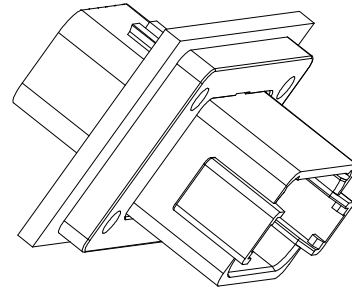

REAR MOUNT

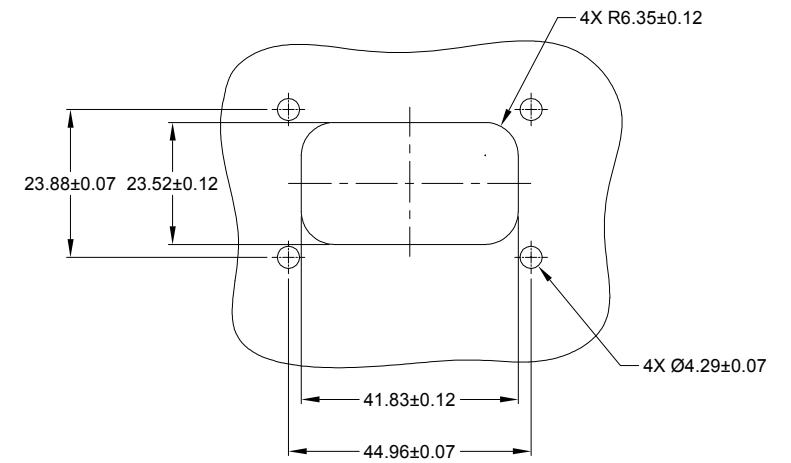

RECOMMENDED CUTOUT  
FRONT AND REAR MOUNT

SEE SHEET 2		DESCRIPTION		ITEM
PART NUMBER				
QUANTITY	MATERIALS LIST			
<b>UNLESS OTHERWISE SPECIFIED</b> 1) All dimensions are in metric(mm). 2) Tolerances are as follows: 1 PL DEC ±0.30 Fractions ±1/64 2 PL DEC ±0.15 Angles ±1° 3 PL DEC ±0.08 3) Note reference =		<b>SIGNATURES</b> <b>DATE</b> DRAWN: ROOKIE    30/NOV/18 CHECKED: ORION    30/NOV/18 ENGINEER: APPROVAL: TOMMY    30/NOV/18		<b>Amphenol</b> Sine Systems - www.amphenol-sine.com 44724 Morley Drive Clinton Township, MI 48036
MATERIAL SPECIFICATIONS:		CUSTOMER:		12P RECEPTACLE, FLANGE MOUNT
PROCESS SPECIFICATIONS:		THIS DRAWING IS SUPPLIED FOR INFORMATION ONLY. DESIGN FEATURES, SPECIFICATIONS AND PERFORMANCE DATA SHOWN HEREON ARE THE PROPERTY OF THE AMPHENOL CORPORATION. NO RIGHTS OF REPRODUCTION ARE IMPLIED. ALL DIMENSIONS ARE SUBJECT TO NORMAL MANUFACTURING VARIATIONS.		SIZE: <b>B C-</b> TYPE:    DWG NO: <b>AT04-12PX-L012</b> REVISION: <b>A1</b>
NEXT ASSY:		SCALE: NONE		SHEET 3 OF 3

TITLE: 12P RECEPTACLE, FLANGE MOUNT    DWG NO.: AT04-12PX-L012    REV: A1    SH: 3    OF: 3

## X-ON Electronics

Largest Supplier of Electrical and Electronic Components

*Click to view similar products for [Automotive Connectors](#) category:*

*Click to view products by [Amphenol](#) manufacturer:*

Other Similar products are found below :

[003-018-000](#) [60403001](#) [60993906-B](#) [M902-2131](#) [M902-2161](#) [72.330.1035.1](#) [73.353.4028.0](#) [F119300-B](#) [F166900](#) [F258300-B](#) [F358300-B](#)  
[F407400](#) [F444110](#) [F487000](#) [F509500B-B](#) [827153-1](#) [8N1515-32-24P](#) [9-1326729-8](#) [925474-1](#) [928905-1](#) [964562-4](#) [968782-1](#) [GT17SA-8DS-](#)  
[HU](#) [98891-1012](#) [98947-1016](#) [12004475-L](#) [12010290](#) [12010309-B](#) [12015454](#) [12020219-B](#) [12020308](#) [12041318-B](#) [12052225-L](#) [12052466](#)  
[12059125](#) [12064869](#) [12004327-B](#) [12010503-B](#) [12015308](#) [12015384](#) [12015909](#) [1-21030-1](#) [12041254](#) [12041318](#) [12047946-B](#) [12047957](#)  
[12047957-L](#) [12059473](#) [12066261](#) [12110546](#)