

REVISIONS					
REV	ECO	DESCRIPTION	DATE	BY	APPR
A3	-	RELEASE NEW DWG FORMAT	27DEC13	JARRY	

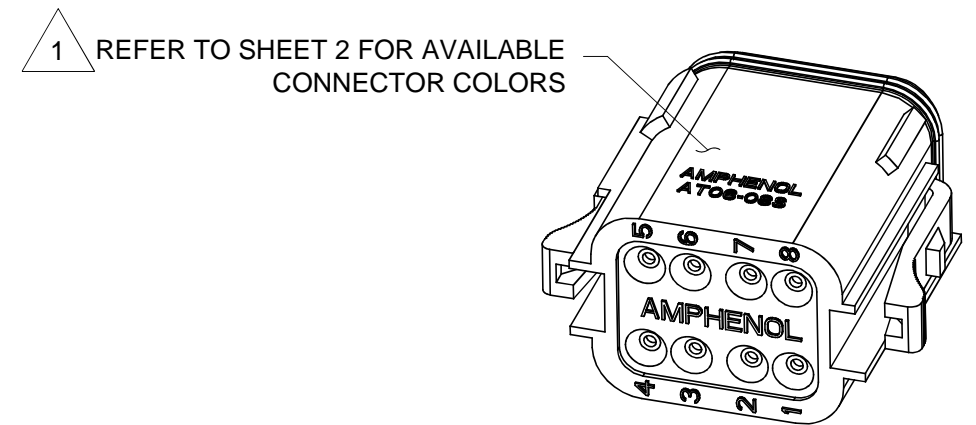
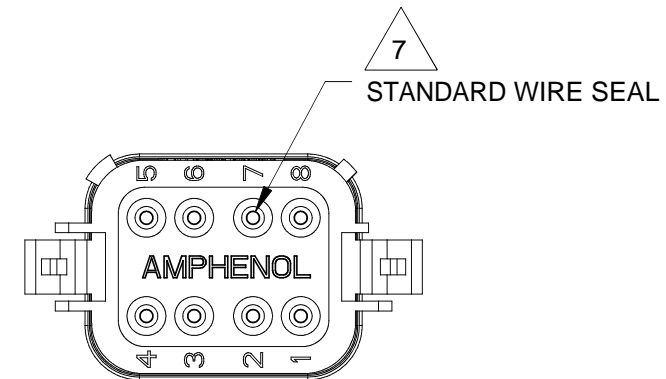
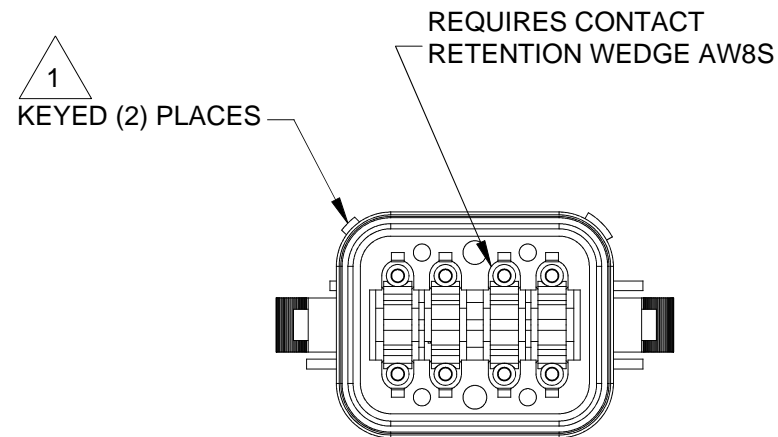
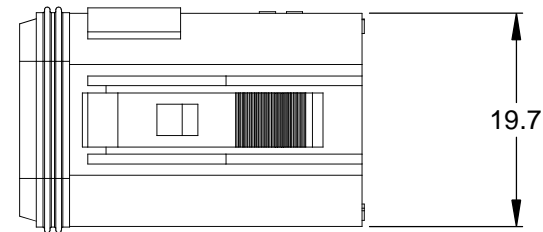
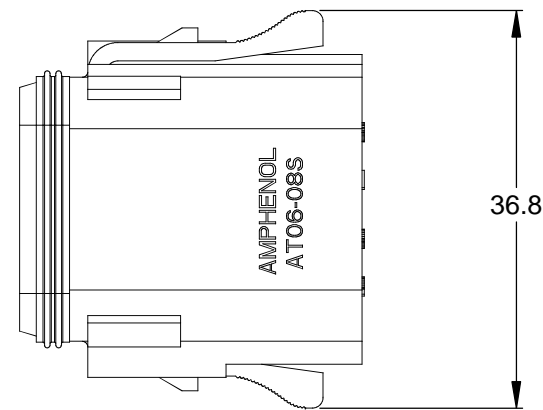

NOTES: UNLESS OTHERWISE SPECIFIED

1 SEE SHEET 2 FOR KEY ARRANGEMENTS AND COLORS.

2. MATERIAL:  
HOUSING: THERMOPLASTIC  
SEAL: SILICONE RUBBER

3. MODIFICATIONS: N/A

4. SPECIFICATIONS:  
4.1 CURRENT RATING: 13 AMPS  
4.2 OPERATING TEMPERATURE: -55°C TO +125°C  
4.3 DIELECTRIC WITHSTANDING VOLTAGE: LESS THAN 2 MILLIAMPS CURRENT LEAKAGE @ 1500 VOLTS AC.  
4.4 INSULATION RESISTANCE: 1000 MEGOHMS MIN @ 25°C.  
4.5 MOISTURE RESISTANCE: IP67 ( MATED CONDITION )  
4.6 MATING CYCLE DURABILITY: 100 CYCLES  
4.7 RoHS COMPLIANT

5. MATING PART: AT04-08PX\* RECEPTACLE  
( X = A,B,C,D KEYS; \* = MODIFICATIONS AND COLORS )

6. ALL DIMENSIONS ARE FOR REFERENCE USE ONLY.

7 CONTACT SIZE AND REAR SEAL WIRE RANGE:

CONTACT SIZE	MIN. INSUL O.D.	MAX. INSUL O.D.	TYPICAL WIRE RANGE
16	2.24 mm (.088 in)	3.68 mm (.145 in)	14 - 20 AWG

TITLE: PLUG, 8 SOCKET, AT SERIES, KEYED

DWG NO: AT06-08SX-XXX

REV: A3

SH: 1

OF: 2

QUANTITY	SEE SHEET 2 PART NUMBER	DESCRIPTION	ITEM												
<b>MATERIALS LIST</b>															
UNLESS OTHERWISE SPECIFIED 1) All dimensions are in metric(mm). 2) Tolerances are as follows: 1 PL DEC ±0.30 2 PL DEC ±0.15 3 PL DEC ±0.08 Fractions ±1/64 Angles ±1° 3) Note reference =		<table border="1"> <tr> <th>SIGNATURES</th> <th>DATE</th> </tr> <tr> <td>DRAWN: JARRY</td> <td>27DEC13</td> </tr> <tr> <td>CHECKED:</td> <td></td> </tr> <tr> <td>ENGINEER:</td> <td></td> </tr> <tr> <td>APPROVAL:</td> <td></td> </tr> <tr> <td>CUSTOMER:</td> <td></td> </tr> </table>		SIGNATURES	DATE	DRAWN: JARRY	27DEC13	CHECKED:		ENGINEER:		APPROVAL:		CUSTOMER:	
SIGNATURES	DATE														
DRAWN: JARRY	27DEC13														
CHECKED:															
ENGINEER:															
APPROVAL:															
CUSTOMER:															
MATERIAL SPECIFICATIONS:		<h1>Amphenol</h1> <p>Sine Systems - www.amphenol-sine.com 44724 Morley Drive Clinton Township, MI 48036</p>													
PROCESS SPECIFICATIONS:		<p>PLUG, 8 SOCKET, AT SERIES, KEYED</p>													
NEXT ASSY:	<table border="1"> <tr> <td>SIZE</td> <td>TYPE</td> <td>DWG NO:</td> <td>REVISION</td> </tr> <tr> <td>B</td> <td>C-</td> <td>AT06-08SX-XXX</td> <td>A3</td> </tr> </table>		SIZE	TYPE	DWG NO:	REVISION	B	C-	AT06-08SX-XXX	A3					
SIZE	TYPE	DWG NO:	REVISION												
B	C-	AT06-08SX-XXX	A3												
		SCALE: NONE	SHEET 1 OF 2												

REVISIONS					
REV	ECO	DESCRIPTION	DATE	BY	APPR

P/N AT06-08SA  
KEY-A CONFIGURATION  
STANDARD COLOR: GREY

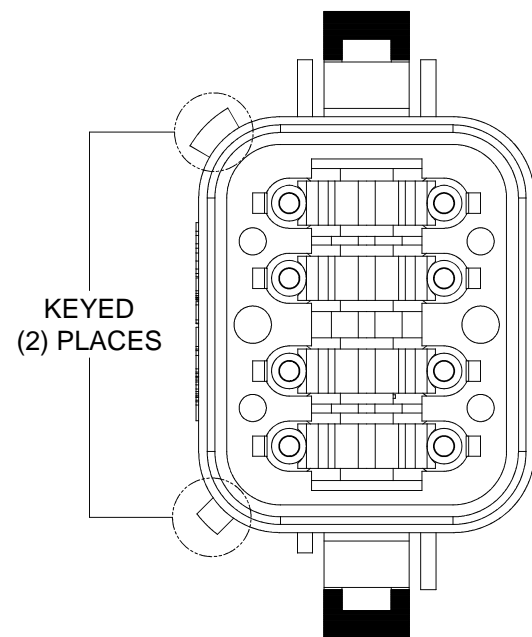

KEY-A CONFIGURATION	
COLOR	PART NUMBER
<b>* GREY</b>	<b>AT06-08SA</b>
BLACK	AT06-08SA-BLK
GREEN	AT06-08SA-GRN
BROWN	AT06-08SA-BRN

P/N AT06-08SB  
KEY-B CONFIGURATION  
STANDARD COLOR: BLACK

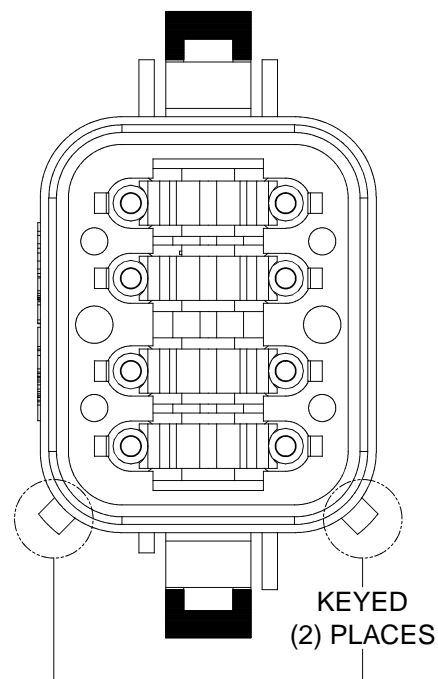

KEY-B CONFIGURATION	
COLOR	PART NUMBER
GREY	AT06-08SB-GRY
<b>* BLACK</b>	<b>AT06-08SB</b>
GREEN	AT06-08SB-GRN
BROWN	AT06-08SB-BRN

P/N AT06-08SC  
KEY-C CONFIGURATION  
STANDARD COLOR: GREEN

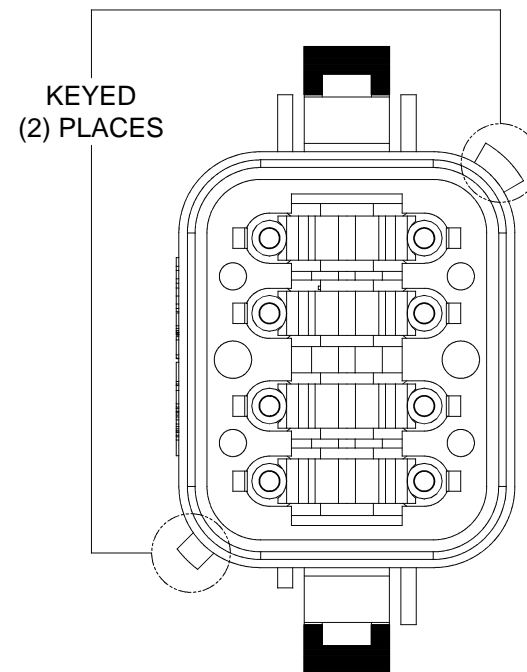

KEY-C CONFIGURATION	
COLOR	PART NUMBER
GREY	AT06-08SC-GRY
BLACK	AT06-08SC-BLK
<b>* GREEN</b>	<b>AT06-08SC</b>
BROWN	AT06-08SC-BRN

P/N AT06-08SD  
KEY-D CONFIGURATION  
STANDARD COLOR: BROWN

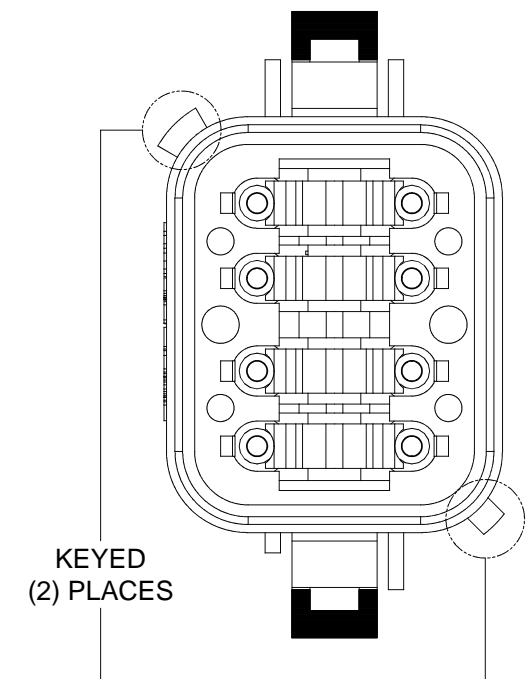

KEY-D CONFIGURATION	
COLOR	PART NUMBER
GREY	AT06-08SD-GRY
BLACK	AT06-08SD-BLK
GREEN	AT06-08SD-GRN
<b>* BROWN</b>	<b>AT06-08SD</b>

NOTE:

AN ASTERISKS ( \* ) PLACED BEFORE THE COLOR DENOTES THE STANDARD MOLDED COLOR OF THE CONNECTORS SHOWN ABOVE.

OTHER COLORS SHOWN ARE AVAILABLE VIA SPECIAL ORDER.

TITLE: PLUG, 8 SOCKET, AT SERIES, KEDED  
DWG NO: AT06-08SX-XXX  
REV: A3  
SH: 2  
OF: 2

QUANTITY	PART NUMBER	DESCRIPTION	ITEM												
<b>MATERIALS LIST</b>															
UNLESS OTHERWISE SPECIFIED 1) All dimensions are in metric(mm). 2) Tolerances are as follows: 1 PL DEC ±0.30 2 PL DEC ±0.15 3 PL DEC ±0.08 Fractions ±1/64 Angles ±1° 3) Note reference =		<table border="1"> <tr> <th>SIGNATURES</th> <th>DATE</th> </tr> <tr> <td>DRAWN: JARRY</td> <td>27DEC13</td> </tr> <tr> <td>CHECKED:</td> <td></td> </tr> <tr> <td>ENGINEER:</td> <td></td> </tr> <tr> <td>APPROVAL:</td> <td></td> </tr> <tr> <td colspan="2">CUSTOMER:</td> </tr> </table>		SIGNATURES	DATE	DRAWN: JARRY	27DEC13	CHECKED:		ENGINEER:		APPROVAL:		CUSTOMER:	
SIGNATURES	DATE														
DRAWN: JARRY	27DEC13														
CHECKED:															
ENGINEER:															
APPROVAL:															
CUSTOMER:															
MATERIAL SPECIFICATIONS:		<h1>Amphenol</h1> <p>Sine Systems - www.amphenol-sine.com 44724 Morley Drive Clinton Township, MI 48036</p> <p><b>PLUG, 8 SOCKET, AT SERIES, KEYED</b></p>													
PROCESS SPECIFICATIONS:															
NEXT ASSY:		<table border="1"> <tr> <td>SIZE: <b>B C-</b></td> <td>DWG NO: <b>AT06-08SX-XXX</b></td> <td>REVISION: <b>A3</b></td> </tr> <tr> <td>SCALE: <b>NONE</b></td> <td colspan="2">SHEET <b>2</b> OF <b>2</b></td> </tr> </table>	SIZE: <b>B C-</b>	DWG NO: <b>AT06-08SX-XXX</b>	REVISION: <b>A3</b>	SCALE: <b>NONE</b>	SHEET <b>2</b> OF <b>2</b>								
SIZE: <b>B C-</b>	DWG NO: <b>AT06-08SX-XXX</b>	REVISION: <b>A3</b>													
SCALE: <b>NONE</b>	SHEET <b>2</b> OF <b>2</b>														

## X-ON Electronics

Largest Supplier of Electrical and Electronic Components

*Click to view similar products for [Automotive Connectors](#) category:*

*Click to view products by [Amphenol](#) manufacturer:*

Other Similar products are found below :

[003-018-000](#) [60403001](#) [60993906-B](#) [M902-2131](#) [M902-2161](#) [72.330.1035.1](#) [73.353.4028.0](#) [F119300-B](#) [F166900](#) [F258300-B](#) [F358300-B](#)  
[F407400](#) [F444110](#) [F487000](#) [F509500B-B](#) [827153-1](#) [8N1515-32-24P](#) [9-1326729-8](#) [925474-1](#) [928905-1](#) [964562-4](#) [968782-1](#) [GT17SA-8DS-](#)  
[HU](#) [98891-1012](#) [98947-1016](#) [12004475-L](#) [12010290](#) [12010309-B](#) [12015454](#) [12020219-B](#) [12020308](#) [12041318-B](#) [12052225-L](#) [12052466](#)  
[12059125](#) [12064869](#) [12004327-B](#) [12010503-B](#) [12015308](#) [12015384](#) [12015909](#) [1-21030-1](#) [12041254](#) [12041318](#) [12047946-B](#) [12047957](#)  
[12047957-L](#) [12059473](#) [12066261](#) [12110546](#)