

REVISIONS					
REV	ECO	DESCRIPTION	DATE	BY	APPR
A3	-	RELEASE NEW DWG FORMAT	03JAN14	JARRY	

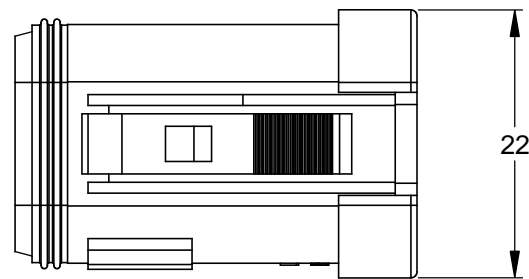

REQUIRES CONTACT RETENTION WEDGE AW8S

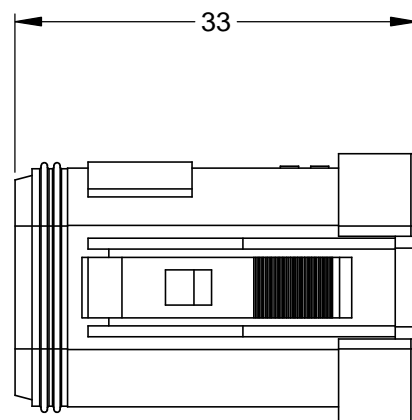
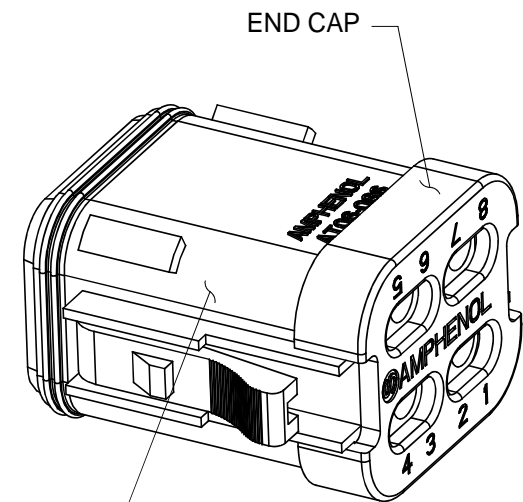
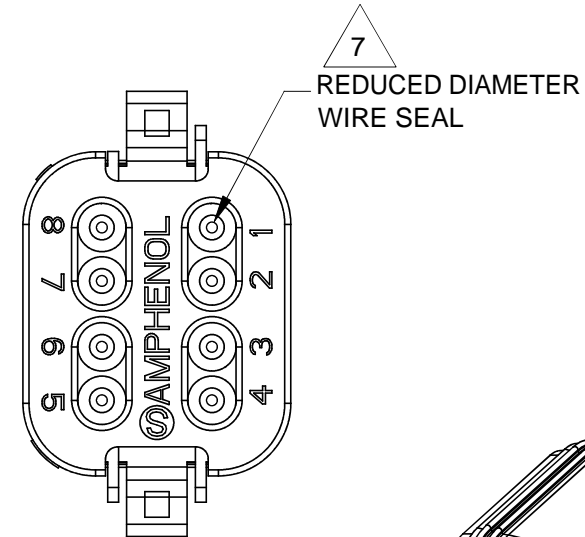
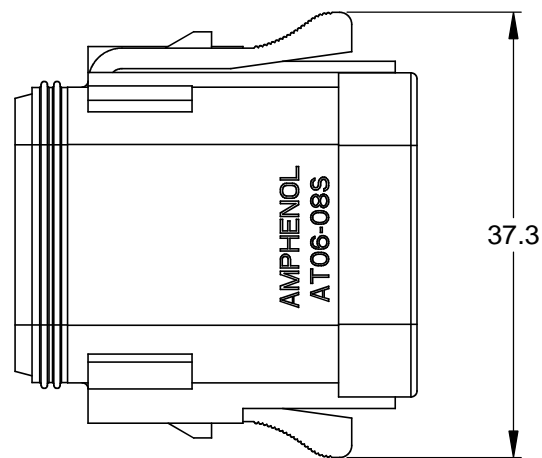
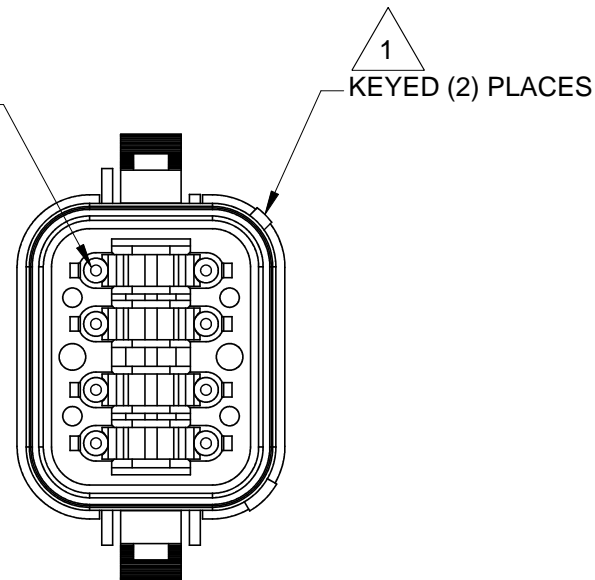

1 REFER TO SHEET 2 FOR AVAILABLE CONNECTOR COLORS

NOTES: UNLESS OTHERWISE SPECIFIED

1 SEE SHEET 2 FOR KEY ARRANGEMENTS AND COLORS.

2. MATERIAL:  
HOUSING: THERMOPLASTIC  
SEAL: SILICONE RUBBER

3. MODIFICATIONS: END CAP;  
REDUCED DIAMETER WIRE SEAL

4. SPECIFICATIONS:  
4.1 CURRENT RATING: 13 AMPS  
4.2 OPERATING TEMPERATURE: -55°C TO +125°C  
4.3 DIELECTRIC WITHSTANDING VOLTAGE: LESS THAN 2 MILLIAMPS CURRENT LEAKAGE @ 1500 VOLTS AC.  
4.4 INSULATION RESISTANCE: 1000 MEGOHMS MIN @ 25°C.  
4.5 MOISTURE RESISTANCE: IP67 ( MATED CONDITION )  
4.6 MATING CYCLE DURABILITY: 100 CYCLES  
4.7 RoHS COMPLIANT

5. MATING PART: AT04-08PX\* RECEPTACLE  
( X = A,B,C,D KEYS; \* = MODIFICATIONS AND COLORS )

6. ALL DIMENSIONS ARE FOR REFERENCE USE ONLY.

7 CONTACT SIZE AND REAR SEAL WIRE RANGE:

CONTACT SIZE	MIN. INSUL O.D.	MAX. INSUL O.D.	TYPICAL WIRE RANGE
16	1.35 mm (.053 in)	3.05 mm (.120 in)	14 - 20 AWG

TITLE: PLUG 8 SOCKET AT END CAP KEYED REDUCED DIA WIRE SEAL

DWG NO: AT06-08SX-MMXXX

REV: A3

SH: 1

OF: 2

SEE PART NUMBER CHART		DESCRIPTION		ITEM
QUANTITY	PART NUMBER	MATERIALS LIST		
UNLESS OTHERWISE SPECIFIED		SIGNATURES		DATE
1) All dimensions are in metric(mm). 2) Tolerances are as follows: 1 PL DEC ±0.30 2 PL DEC ±0.15 3 PL DEC ±0.08		DRAWN: JARRY		03JAN14
3) Note reference = X		CHECKED:		
FRACTIONS ±1/64 ANGLES ±1°		ENGINEER:		
MATERIAL SPECIFICATIONS:		APPROVAL:		
PROCESS SPECIFICATIONS:		CUSTOMER:		
NEXT ASSY:		THIS DRAWING IS SUPPLIED FOR INFORMATION ONLY. DESIGN FEATURES, SPECIFICATIONS AND PERFORMANCE DATA SHOWN HEREON ARE THE PROPERTY OF THE AMPHENOL CORPORATION. NO RIGHTS OF REPRODUCTION ARE IMPLIED. ALL DIMENSIONS ARE SUBJECT TO NORMAL MANUFACTURING VARIATIONS.		
		<p style="text-align: center;"><b>Amphenol</b></p> <p style="text-align: center;">Sine Systems - www.amphenol-sine.com 44724 Morley Drive Clinton Township, MI 48036</p>		
		<p style="text-align: center;">PLUG, 8 SOCKET, AT SERIES, END CAP, KEYED, REDUCED DIAMETER WIRE SEAL</p>		
SIZE	TYPE	DWG NO:	REVISION	
B	C-	AT06-08SX-MMXXX	A3	
SCALE:	NONE	SHEET 1 OF 2		

REVISIONS					
REV	ECO	DESCRIPTION	DATE	BY	APPR

P/N AT06-08SA-MM01  
KEY-A CONFIGURATION  
STANDARD COLOR: GREY

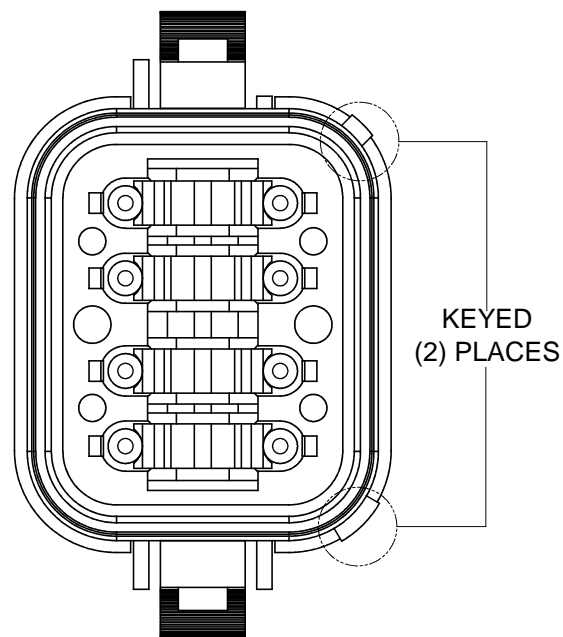

KEY-A CONFIGURATION	
COLOR	PART NUMBER
<b>* GREY</b>	<b>AT06-08SA-MM01</b>
BLACK	AT06-08SA-MMBLK
GREEN	AT06-08SA-MMGRN
BROWN	AT06-08SA-MMBRN

P/N AT06-08SB-MM01  
KEY-B CONFIGURATION  
STANDARD COLOR: BLACK

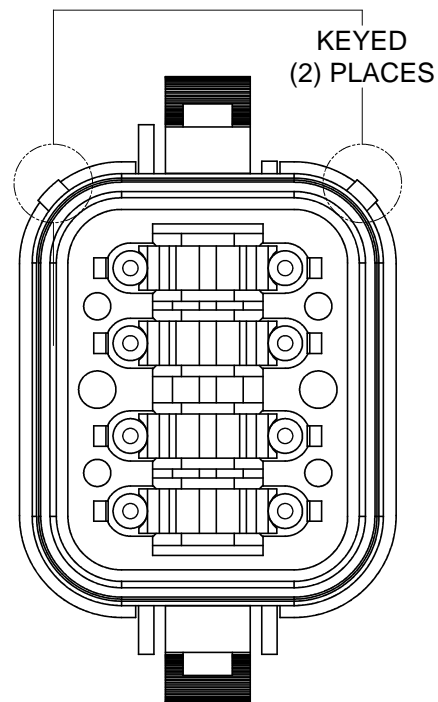

KEY-B CONFIGURATION	
COLOR	PART NUMBER
GREY	AT06-08SB-MMGRY
<b>* BLACK</b>	<b>AT06-08SB-MM01</b>
GREEN	AT06-08SB-MMGRN
BROWN	AT06-08SB-MMBRN

P/N AT06-08SC-MM01  
KEY-C CONFIGURATION  
STANDARD COLOR: GREEN

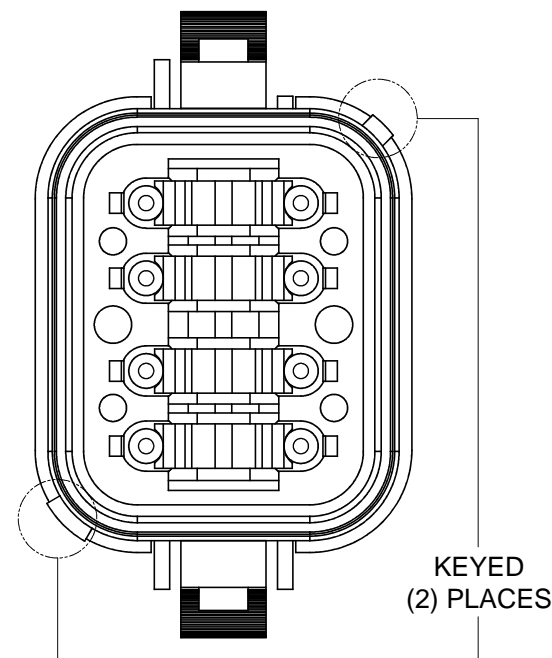

KEY-C CONFIGURATION	
COLOR	PART NUMBER
GREY	AT06-08SC-MMGRY
BLACK	AT06-08SC-MMBLK
<b>* GREEN</b>	<b>AT06-08SC-MM01</b>
BROWN	AT06-08SC-MMBRN

P/N AT06-08SD-MM01  
KEY-D CONFIGURATION  
STANDARD COLOR: BROWN

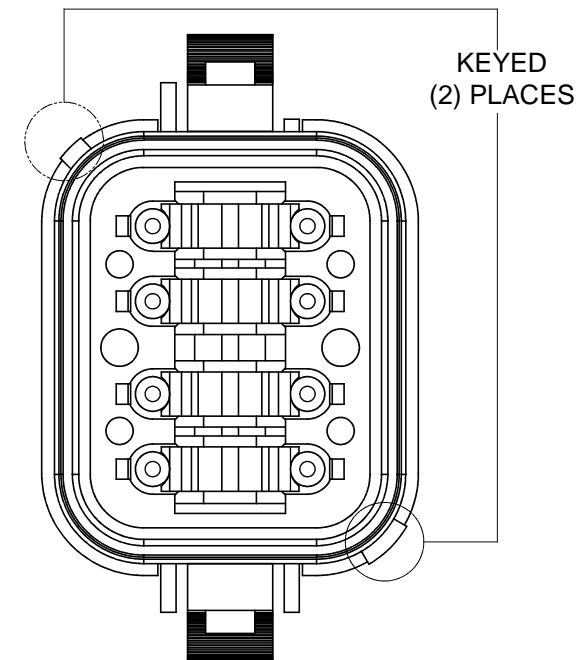

KEY-D CONFIGURATION	
COLOR	PART NUMBER
GREY	AT06-08SD-MMGRY
BLACK	AT06-08SD-MMBLK
GREEN	AT06-08SD-MMGRN
<b>* BROWN</b>	<b>AT06-08SD-MM01</b>

NOTE:

AN ASTERISKS ( \* ) PLACED BEFORE THE COLOR DENOTES THE STANDARD MOLDED COLOR OF THE CONNECTORS SHOWN ABOVE.



OTHER COLORS SHOWN ARE AVAILABLE VIA SPECIAL ORDER.



TITLE: PLUG 8 SOCKET AT END CAP KEYED REDUCED DIA WIRE SEAL  
DWG NO: AT06-08SX-MMXXX  
REV: A3  
SH: 2  
OF: 2

SEE PART NUMBER CHART		DESCRIPTION	ITEM
QUANTITY	PART NUMBER		
<b>MATERIALS LIST</b>			
UNLESS OTHERWISE SPECIFIED 1) All dimensions are in metric(mm). 2) Tolerances are as follows: 1 PL DEC ±0.30 2 PL DEC ±0.15 3 PL DEC ±0.08 Fractions ±1/64 Angles ±1° 3) Note reference =		<b>SIGNATURES</b> <b>DATE</b> DRAWN: JARRY    03JAN14 CHECKED: ENGINEER: APPROVAL:	
<b>MATERIAL SPECIFICATIONS:</b>		<div style="text-align: center;"> <h1>Amphenol</h1> <p>Sine Systems - www.amphenol-sine.com 44724 Morley Drive Clinton Township, MI 48036</p> <p><b>PLUG, 8 SOCKET, AT SERIES, END CAP, KEYED, REDUCED DIAMETER WIRE SEAL</b></p> </div>	
<b>PROCESS SPECIFICATIONS:</b>			
<b>NEXT ASSY:</b>		THIS DRAWING IS SUPPLIED FOR INFORMATION ONLY. DESIGN FEATURES, SPECIFICATIONS AND PERFORMANCE DATA SHOWN HEREON ARE THE PROPERTY OF THE AMPHENOL CORPORATION. NO RIGHTS OF REPRODUCTION ARE IMPLIED. ALL DIMENSIONS ARE SUBJECT TO NORMAL MANUFACTURING VARIATIONS.	
		SIZE: <b>B C-</b> SCALE: NONE	DWG NO: <b>AT06-08SX-MMXXX</b> REVISION: <b>A3</b> SHEET 2 OF 2



## AT Series™ - Contact Size 16 Options

Machined Contacts, Sockets & Pins				
Part Number	Description	Size	AWG	Type
AT60-215-1631	Male Contact - Pin, Gold-plated	16	14	Machined
AT62-209-1631	Female Contact - Socket, Gold-plated	16	14	Machined
AT60-215-16141	Male Contact - Pin, Nickel-plated	16	14	Machined
AT62-209-16141	Female Contact - Socket, Nickel-plated	16	14	Machined
AT60-202-1631	Male Contact - Pin, Gold-plated	16	16-20	Machined
AT62-201-1631	Female Contact - Socket, Gold-plated	16	16-20	Machined
AT60-202-16141	Male Contact - Pin, Nickel-plated	16	16-20	Machined
AT62-201-16141	Female Contact - Socket, Nickel-plated	16	16-20	Machined
AT60-202-1631-22	Male Contact - Pin, Gold-plated	16	22-24	Machined
AT62-201-1631-22	Female Contact - Socket, Gold-plated	16	22-24	Machined
AT60-202-16141-22	Male Contact - Pin, Nickel-plated	16	22-24	Machined
AT62-201-16141-22	Female Contact - Socket, Nickel-plated	16	22-24	Machined

Tooling - Machined Contacts		
Part	Part Number	Description
	CA-5D12	Universal Hand Crimp Tool, Size 12/16/20 (Machined contacts only)
	CA-5E12	Pneumatic Crimp Tool, Size 12/16/20 (Machined contacts only)

Contact Removal Tools		
Part	Part Number	Description
	ATRT-100	Used for removal of contacts for A Series™ products
	AT11-310-1605	Contact Removal Tool, Plastic, Size 16
	A114017	Sealing Plug, Size 16, White

Stamped & Formed Contacts, Sockets & Pins				
Part Number	Description	Size	AWG	Type
AT60-14-0144	Male Contact - Pin, Gold-plated	16	14-16	Stamped & Formed
AT62-14-0144	Female Contact - Socket, Gold-plated	16	14-16	Stamped & Formed
AT60-14-0122	Male Contact - Pin, Nickel-plated	16	14-16	Stamped & Formed
AT62-14-0122	Female Contact - Socket, Nickel-plated	16	14-16	Stamped & Formed
AT60-16-0144	Male Contact - Pin, Gold-plated	16	16-18	Stamped & Formed
AT62-16-0144	Female Contact - Socket, Gold-plated	16	16-18	Stamped & Formed
AT60-16-0122	Male Contact - Pin, Nickel-plated	16	16-18	Stamped & Formed
AT62-16-0122	Female Contact - Socket, Nickel-plated	16	16-18	Stamped & Formed
AT60-16-0644	Male Contact - Pin, Gold-plated	16	18-20	Stamped & Formed
AT62-16-0644	Female Contact - Socket, Gold-plated	16	18-20	Stamped & Formed
AT60-16-0622	Male Contact - Pin, Nickel-plated	16	18-20	Stamped & Formed
AT62-16-0622	Female Contact - Socket, Nickel-plated	16	18-20	Stamped & Formed
AT60-16-0844	Male Contact - Pin, Gold-plated	16	20-22	Stamped & Formed
AT62-16-0844	Female Contact - Socket, Gold-plated	16	20-22	Stamped & Formed
AT60-16-0822	Male Contact - Pin, Nickel-plated	16	20-22	Stamped & Formed
AT62-16-0822	Female Contact - Socket, Nickel-plated	16	20-22	Stamped & Formed

Tooling - Stamped & Formed Contacts		
Part	Part Number	Description
	MFX-3950	Crimp Die - Size 16, 18-20AWG (S&F contacts only)
	MFX-3953	Crimp Die - Size 16, 16-18AWG (S&F contacts only)
	MFX-3975	Crimp Die - Size 16, 14-16AWG (S&F contacts only)
	MFX-3990	Crimp Die - Size 16, 20-22AWG (S&F contacts only)
	ATT-16-00	Hand Crimp Tool - Size 16, 14-16AWG (S&F contacts only)
	ATT-16-01	Hand Crimp Tool - Size 16, 18-20AWG (S&F contacts only)
	ATT-1612-03	Hand Crimp Tool - Size 16, 20-22AWG (S&F contacts only)

**Amphenol Sine Systems**  
 44724 Morley Drive  
 Clinton Township, MI 48036 USA  
[www.amphenol-sine.com](http://www.amphenol-sine.com)  
 09/2021

## X-ON Electronics

Largest Supplier of Electrical and Electronic Components

*Click to view similar products for [Automotive Connectors](#) category:*

*Click to view products by [Amphenol](#) manufacturer:*

Other Similar products are found below :

[003-018-000](#) [60403001](#) [60993906-B](#) [M902-2131](#) [M902-2161](#) [72.330.1035.1](#) [73.353.4028.0](#) [F119300-B](#) [F166900](#) [F258300-B](#) [F358300-B](#)  
[F407400](#) [F444110](#) [F487000](#) [F509500B-B](#) [827153-1](#) [8N1515-32-24P](#) [9-1326729-8](#) [925474-1](#) [928905-1](#) [964562-4](#) [968782-1](#) [GT17SA-8DS-](#)  
[HU](#) [98891-1012](#) [98947-1016](#) [12004475-L](#) [12010290](#) [12010309-B](#) [12015454](#) [12020219-B](#) [12020308](#) [12041318-B](#) [12052225-L](#) [12052466](#)  
[12059125](#) [12064869](#) [12004327-B](#) [12010503-B](#) [12015308](#) [12015384](#) [12015909](#) [1-21030-1](#) [12041254](#) [12041318](#) [12047946-B](#) [12047957](#)  
[12047957-L](#) [12059473](#) [12066261](#) [12110546](#)