

RECOMMENDED SCREW: 4-20 [M3.12 x 1.27]
 THREAD-FORMING SCREW,
 TORQUE: 6-10 IN-LB [0.68-1.13 NM]

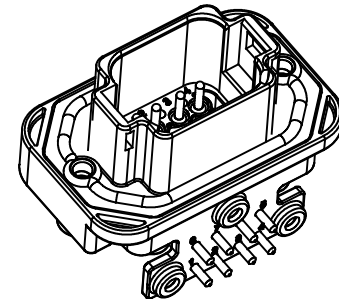
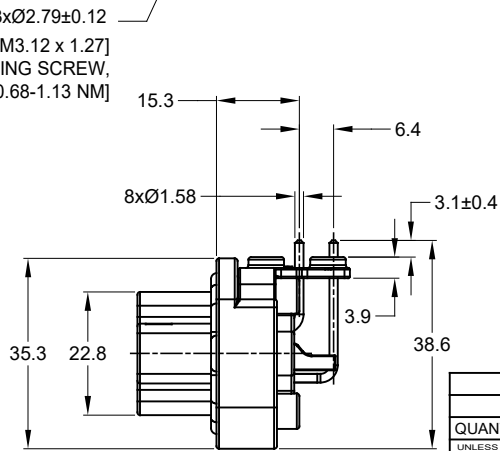

NOTES: UNLESS OTHERWISE SPECIFIED

- MATERIAL:
 HOUSING: THERMOPLASTIC
 SEAL: SILICONE RUBBER
 CONTACT: COPPER ALLOY
- MODIFICATIONS: FLANGE, PCB MOUNT, RIGHT ANGLE
- SPECIFICATIONS:
 3.1 CURRENT RATING: 13 AMPS
 3.2 OPERATING TEMPERATURE: -55°C TO +125°C
 3.3 DIELECTRIC WITHSTANDING VOLTAGE: LESS THAN 2 MILLIAMPS CURRENT LEAKAGE @ 1500 VOLTS AC.
 3.4 INSULATION RESISTANCE: 1000 MEGOHMS MIN @ 25°C.
 3.5 MOISTURE RESISTANCE: IP67 (MATED CONDITION)
 3.6 MATING CYCLE DURABILITY: 100 CYCLES
 3.7 RoHS COMPLIANT
- MATING PART: AT06-08S* PLUG
 (* = MODIFICATIONS)
- ALL DIMENSIONS ARE FOR REFERENCE USE ONLY.
- POTTED CONNECTORS SPECIFIED FOR UP TO 5 P.S.I. APPLICATIONS.

REVISIONS					
REV	ECO	DESCRIPTION	DATE	BY	APPR
A1	-	RELEASE NEW DRAWING	19JUN18	JONY	TOMMY
A2	-	REVISED DRAWING	10JUL20	JHEAD	DH

TITLE: PCB MOUNT RECEPTACLE PIN, RA FLANGE AT SERIES
 DWG NO.: AT13-08PX-BMXX
 REV: A2
 SH: 1
 OF: 3

AT13-08PX-BMXX		REF: DT13-08PA, DT13-08PB, DT13-08PC, DT13-08PD, DT13-08PA-G003, DT13-08PB-G003		ITEM
PART NUMBER		DESCRIPTION		ITEM
QUANTITY	MATERIALS LIST			
UNLESS OTHERWISE SPECIFIED		SIGNATURES	DATE	 Sine Systems - www.amphenol-sine.com 44724 Morley Drive Clinton Township, MI 48036
1) All dimensions are in metric (mm)		DRAWN: JONY.XIE	19JUN18	
2) Tolerances are as follows:		CHECKED: JONY.XIE	19JUN18	
1 PL DEC ±0.30 Fractions ±1/64		ENGINEER:		
3 PL DEC ±0.15 Angles ±1°		APPROVAL: TOMMY.XIE	19JUN18	BOARDLOCK PCB MOUNT RECEPTACLE, 8 PIN, RA FLANGE, AT SERIES
3) Note reference =		CUSTOMER:		
MATERIAL SPECIFICATIONS:		THIS DRAWING IS SUPPLIED FOR INFORMATION ONLY. DESIGN FEATURES, SPECIFICATIONS AND PERFORMANCE DATA SHOWN HEREON ARE THE PROPERTY OF THE AMPHENOL CORPORATION. NO RIGHTS OF REPRODUCTION ARE IMPLIED. ALL DIMENSIONS ARE SUBJECT TO NORMAL MANUFACTURING VARIATIONS.		
PROCESS SPECIFICATIONS:	SIZE: B	TYPE: C-	DWG NO.: AT13-08PX-BMXX	REVISION: A2
NEXT ASSY:	SCALE: NONE	SHEET 1 OF 3		

P/N AT13-08PA-BMXX
KEY-A CONFIGURATION
STANDARD COLOR: GREY

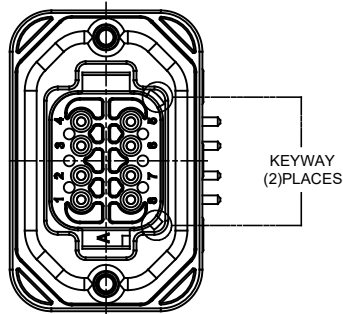

AT13-08PA-BMXX VARIANTS		
CONTACT PLATING	POTTING OR NOT IN RESERVOIR	PART NUMBER
GOLD	NO POTTING	AT13-08PA-BM01
GOLD	POTTING	AT13-08PA-BM02
TIN	NO POTTING	AT13-08PA-BM03
TIN	POTTING	AT13-08PA-BM04

REVISIONS					
REV	ECO	DESCRIPTION	DATE	BY	APPR
A1	--	RELEASE NEW DRAWING	19JUN18	JONY	TOMMY
A2	--	REVISED DRAWING	10JUL20	JHEAD	DH

P/N AT13-08PB-BMXX
KEY-B CONFIGURATION
STANDARD COLOR: BLACK

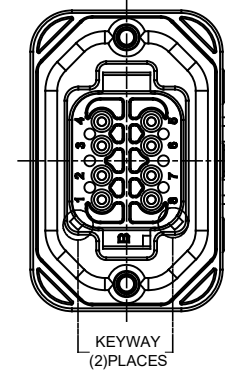

AT13-08PB-BMXX VARIANTS		
CONTACT PLATING	POTTING OR NOT IN RESERVOIR	PART NUMBER
GOLD	NO POTTING	AT13-08PB-BM01
GOLD	POTTING	AT13-08PB-BM02
TIN	NO POTTING	AT13-08PB-BM03
TIN	POTTING	AT13-08PB-BM04

AT13-08PX-BMXX		DESCRIPTION	
QUANTITY	PART NUMBER	DESCRIPTION	ITEM
MATERIALS LIST			
<small>UNLESS OTHERWISE SPECIFIED</small> 1) All dimensions are in metric(mm). 2) Tolerances are as follows: 1 PL DEC ±0.30 Fractions ±1/64 2 PL DEC ±0.15 3 PL DEC ±0.08 3) Note reference =		SIGNATURES DATE DRAWN: JONY XIE 19JUN18 CHECKED: ORION LI 19JUN18 ENGINEER: APPROVAL: TOMMY XIE 19JUN18 CUSTOMER:	
<small>MATERIAL SPECIFICATIONS:</small> THIS DRAWING IS SUPPLIED FOR INFORMATION ONLY. DESIGN FEATURES, SPECIFICATIONS AND PERFORMANCE DATA SHOWN HEREON ARE THE PROPERTY OF THE AMPHENOL CORPORATION. NO RIGHTS OF REPRODUCTION ARE IMPLIED. ALL DIMENSIONS ARE SUBJECT TO NORMAL MANUFACTURING VARIATIONS.		<h1>Amphenol</h1> Sine Systems - www.amphenol-sine.com 44724 Morley Drive Clinton Township, MI 48036 BOARDLOCK PCB MOUNT RECEPTACLE, 8 PIN, RA FLANGE, AT SERIES	
<small>PROCESS SPECIFICATIONS:</small> NEXT ASSY:		SIZE: B TYPE: C- SCALE: NONE	DWG NO.: AT13-08PX-BMXX REVISION: A2 SHEET 2 OF 3

TITLE: PCB MOUNT RECEPTACLE 8PIN RA FLANGE AT SERIES
 DWG NO.: AT13-08PX-BMXX
 REV: A2
 SH: 2
 OF: 3

P/N AT13-08PC-BMXX
KEY-C CONFIGURATION
STANDARD COLOR: GREEN

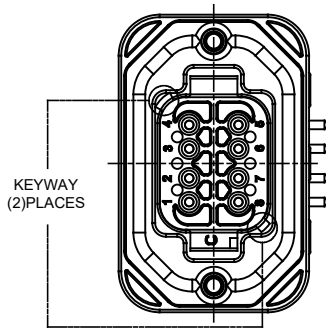

AT13-08PC-BMXX VARIANTS		
CONTACT PLATING	POTTING OR NOT IN RESERVOIR	PART NUMBER
GOLD	NO POTTING	AT13-08PC-BM01
GOLD	POTTING	AT13-08PC-BM02
TIN	NO POTTING	AT13-08PC-BM03
TIN	POTTING	AT13-08PC-BM04

P/N AT13-08PD-BMXX
KEY-D CONFIGURATION
STANDARD COLOR: BROWN

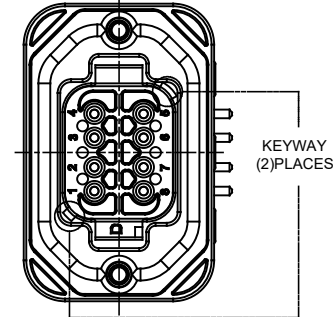

AT13-08PD-BMXX VARIANTS		
CONTACT PLATING	POTTING OR NOT IN RESERVOIR	PART NUMBER
GOLD	NO POTTING	AT13-08PD-BM01
GOLD	POTTING	AT13-08PD-BM02
TIN	NO POTTING	AT13-08PD-BM03
TIN	POTTING	AT13-08PD-BM04

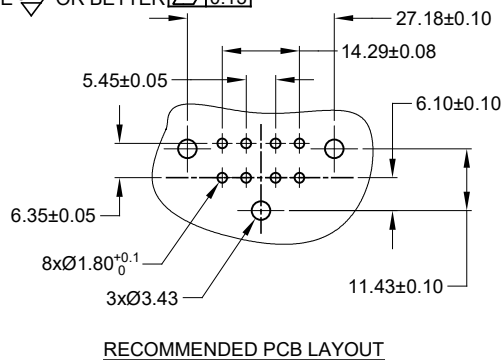
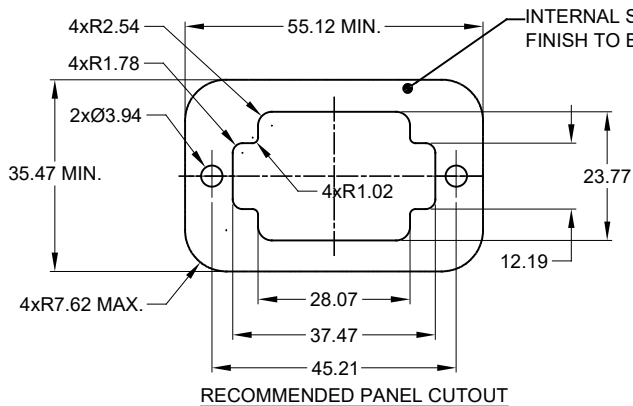

REVISIONS					
REV	ECO	DESCRIPTION	DATE	BY	APPR
A1	--	RELEASE NEW DRAWING	19JUN18	JONY	TOMMY
A2	--	REVISED DRAWING	10JUL20	JHEAD	DH

AT13-08PX-BMXX		DESCRIPTION	
QUANTITY	PART NUMBER	ITEM	
MATERIALS LIST			
UNLESS OTHERWISE SPECIFIED: 1) All dimensions are in metric(mm) 2) Tolerances are as follows: 1 PL DEC ±0.30 2 PL DEC ±0.15 3 PL DEC ±0.08 3) Note reference =		SIGNATURES DATE DRAWN: JONY XIE 19JUN18 CHECKED: ORION LI 19JUN18 ENGINEER: APPROVAL: TOMMY XIE 19JUN18	
MATERIAL SPECIFICATIONS:		CUSTOMER:	
PROCESS SPECIFICATIONS:		THIS DRAWING IS SUPPLIED FOR INFORMATION ONLY. DESIGN FEATURES, SPECIFICATIONS AND PERFORMANCE DATA SHOWN HEREON ARE THE PROPERTY OF THE AMPHENOL CORPORATION. NO RIGHTS OF REPRODUCTION ARE IMPLIED. ALL DIMENSIONS ARE SUBJECT TO NORMAL MANUFACTURING VARIATIONS.	
NEXT ASSY:		SIZE: B	TYPE: C-
		DWG NO: AT13-08PX-BMXX	REVISION: A2
		SCALE: NONE	SHEET 3 OF 3

TITLE: PCB MOUNT RECEPTACLE, 8 PIN, RA FLANGE, AT SERIES
DWG NO: AT13-08PX-BMXX
REV: A2
SH: 3
OF: 3

X-ON Electronics

Largest Supplier of Electrical and Electronic Components

Click to view similar products for [Automotive Connectors](#) category:

Click to view products by [Amphenol](#) manufacturer:

Other Similar products are found below :

[003-018-000](#) [60403001](#) [60993906-B](#) [M902-2131](#) [M902-2161](#) [72.330.1035.1](#) [73.353.4028.0](#) [F119300-B](#) [F166900](#) [F258300-B](#) [F358300-B](#)
[F407400](#) [F444110](#) [F487000](#) [F509500B-B](#) [827153-1](#) [8N1515-32-24P](#) [9-1326729-8](#) [925474-1](#) [928905-1](#) [964562-4](#) [968782-1](#) [GT17SA-8DS-](#)
[HU](#) [98891-1012](#) [98947-1016](#) [12004475-L](#) [12010290](#) [12010309-B](#) [12015454](#) [12020219-B](#) [12020308](#) [12041318-B](#) [12052225-L](#) [12052466](#)
[12059125](#) [12064869](#) [12004327-B](#) [12010503-B](#) [12015308](#) [12015384](#) [12015909](#) [1-21030-1](#) [12041254](#) [12041318](#) [12047946-B](#) [12047957](#)
[12047957-L](#) [12059473](#) [12066261](#) [12110546](#)