

REVISIONS					
REV	ECO	DESCRIPTION	DATE	BY	APPR
A1	-	NEW RELEASE	13DEC19	ZENIN	TOMMY

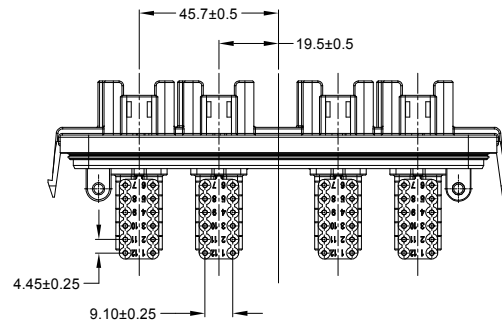
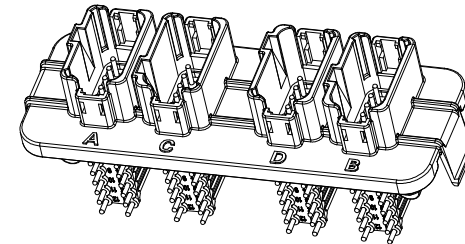
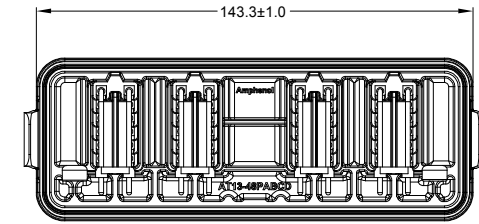
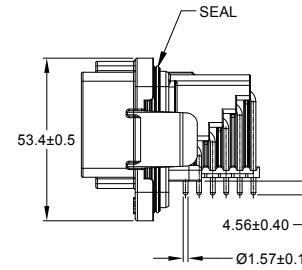
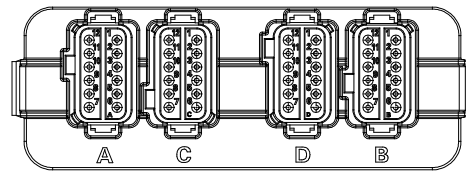
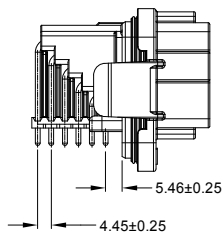
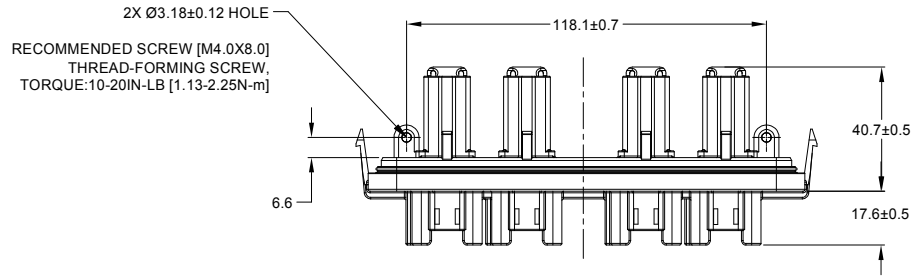

NOTES: UNLESS OTHERWISE SPECIFIED

- MATERIAL:
 - HOUSING: THERMOPLASTIC, BLACK
 - SEAL: SILICONE RUBBER
 - CONTACT: COPPER ALLOY
- MODIFICATIONS: RA PCB MOUNT
- SPECIFICATIONS:
 - 3.1 CURRENT RATING: 13 AMPS
 - 3.2 OPERATING TEMPERATURE: -55°C TO +125°C
 - 3.3 DIELECTRIC WITHSTANDING VOLTAGE: LESS THAN 2 MILLIAMPS CURRENT LEAKAGE @ 1500 VOLTS AC
 - 3.4 INSULATION RESISTANCE: 1000 MEGOHMS MIN @ 25°C
 - 3.5 MOISTURE RESISTANCE: IP67 (MATED CONDITION)
 - 3.6 MATING CYCLE DURABILITY: 100 CYCLES
 - 3.7 RoHS COMPLIANT
- MATING PART: AT06-12SX-*
(X = A,B,C,D KEYS ; * = ALL MODIFICATIONS)
- THIS RECEPTACLE IS USED WITH AIPXE-5X650A-xxxx AND AIPXE-5X650B-xxxx ENCLOSURE (xxxx= ALL MODIFICATIONS)
- SEE SHEET 2&3 FOR OTHER KEY ARRANGEMENTS
- ALL DIMENSIONS ARE FOR REFERENCE USE ONLY

SEE SHEET 2&3		DESCRIPTION		ITEM
QUANTITY	PART NUMBER	MATERIALS LIST		
<p>UNLESS OTHERWISE SPECIFIED</p> <p>1) All dimensions are in metric(mm).</p> <p>2) Tolerances are as follows:</p> <p>1 PL DEC ±0.30 Fractions ±1/64</p> <p>2 PL DEC ±0.15 Angles ±1°</p> <p>3 PL DEC ±0.08</p> <p>3) Note reference = </p>				
SIGNATURES		DATE		
DRAWN: ZENIN DENG		13DEC19		
CHECKED: ORION LI		13DEC19		
ENGINEER:		APPROVAL: TOMMY XIE 13DEC19		
APPROVAL:		CUSTOMER:		
MATERIAL SPECIFICATIONS:		THIS DRAWING IS SUPPLIED FOR INFORMATION ONLY. DESIGN FEATURES, SPECIFICATIONS AND PERFORMANCE DATA SHOWN HEREON ARE THE PROPERTY OF THE AMPHENOL CORPORATION. NO RIGHTS OF REPRODUCTION ARE IMPLIED. ALL DIMENSIONS ARE SUBJECT TO NORMAL MANUFACTURING VARIATIONS.		
PROCESS SPECIFICATIONS:		NEXT ASSY:		
SIZE		TYPE		REVISION
B C-		AT13-XPX-XXXX		A1
SCALE		NONE		SHEET 1 OF 3

TITLE: ARMOR IPX RECEPTACLE AT HEADER, 4 X 12POS, 16# SIZE PIN
 DWG NO: AT13-XPX-XXXX
 REV: A1
 SH: 1
 OF: 3

Amphenol
 Sine Systems - www.amphenol-sine.com
 44724 Morley Drive
 Clinton Township, MI 48036

ARMOR IPX RECEPTACLE AT HEADER,
 4 X 12POS, 16# SIZE PIN

REVISIONS					
REV	ECO	DESCRIPTION	DATE	BY	APPR
A1	-	NEW RELEASE	13DEC19	ZENIN	TOMMY

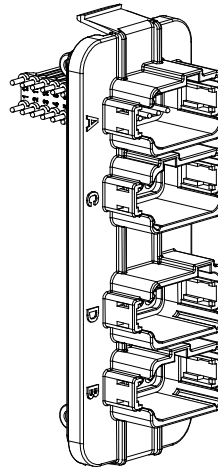
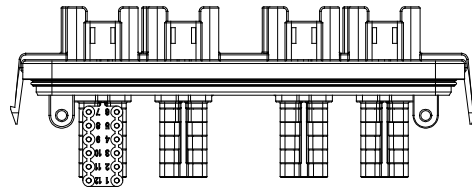
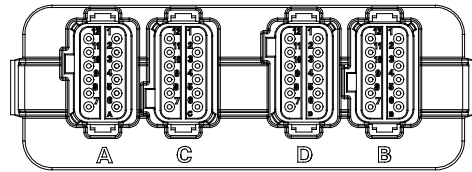

KEY A

AT13-12PA-XXXX VARIANTS		
CONTACT PLATING	PART NUMBER	REFERENCE
GOLD	AT13-12PA-GR02	DT13-12PA-GR02
TIN	AT13-12PA-R015	DT13-12PA-R015

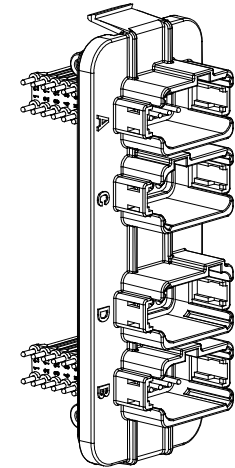
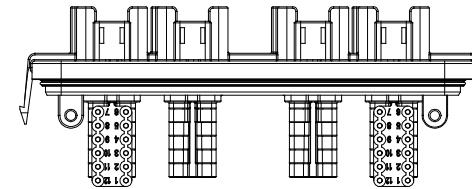
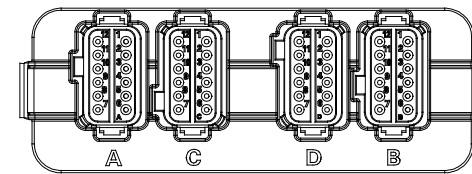

KEY A B

AT13-24PAB-XXXX VARIANTS		
CONTACT PLATING	PART NUMBER	REFERENCE
GOLD	AT13-24PAB-BM01	DT13-24PAB-GR02
TIN	AT13-24PAB-BM03	DT13-24PAB-R015

AT13-XPX-XXXX		DESCRIPTION		ITEM
QUANTITY	PART NUMBER	MATERIALS LIST		
<p>UNLESS OTHERWISE SPECIFIED</p> <p>1) All dimensions are in metric(mm).</p> <p>2) Tolerances are as follows:</p> <p>1 PL DEC ±0.30 Fractions ±1/64</p> <p>2 PL DEC ±0.15 Angles ±1°</p> <p>3 PL DEC ±0.08</p> <p>3) Note reference = </p>				
<p>SIGNATURES</p> <p>DRAWN: ZENIN DENG DATE: 13DEC19</p> <p>CHECKED: ORION LI DATE: 13DEC19</p> <p>ENGINEER:</p> <p>APPROVAL: TOMMY XIE DATE: 13DEC19</p>		<p>Amphenol</p> <p>Sine Systems - www.amphenol-sine.com 44724 Morley Drive Clinton Township, MI 48036</p>		
<p>MATERIAL SPECIFICATIONS:</p> <p>PROCESS SPECIFICATIONS:</p> <p>NEXT ASSY:</p>		<p>THIS DRAWING IS SUPPLIED FOR INFORMATION ONLY. DESIGN FEATURES, SPECIFICATIONS AND PERFORMANCE DATA SHOWN HEREON ARE THE PROPERTY OF THE AMPHENOL CORPORATION. NO RIGHTS OF REPRODUCTION ARE IMPLIED. ALL DIMENSIONS ARE SUBJECT TO NORMAL MANUFACTURING VARIATIONS.</p>		
		<p>SIZE TYPE DWG NO. REVISION</p> <p>B C- AT13-XPX-XXXX A1</p>	<p>SCALE: NONE</p> <p>SHEET 2 OF 3</p>	

TITLE: ARMOR IPX RECEPTACLE AT HEADER, 4 X 12POS, 16# SIZE PIN
 DWG NO.: AT13-XPX-XXXX
 REV: A1
 SH: 2
 OF: 3

REVISIONS					
REV	ECO	DESCRIPTION	DATE	BY	APPR
A1	-	NEW RELEASE	13DEC19	ZENIN	TOMMY

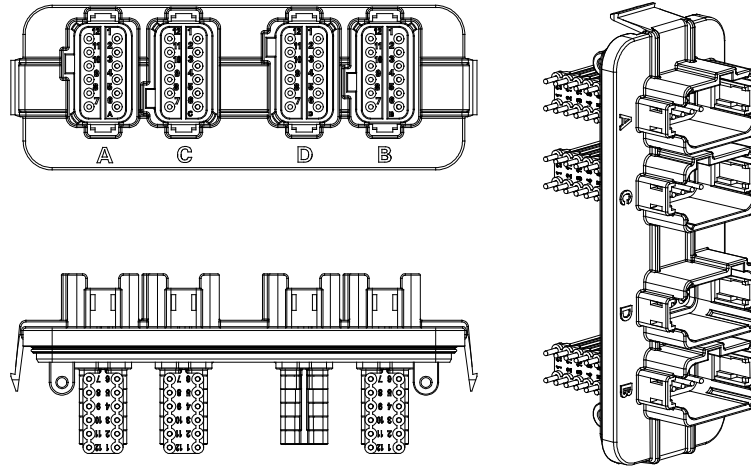

KEY A B C

AT13-36PABC-XXXX VARIANTS		
CONTACT PLATING	PART NUMBER	REFERENCE
GOLD	AT13-36PABC-BM01	DT13-36PAB-GR02
TIN	AT13-36PABC-BM03	DT13-36PAB-R015

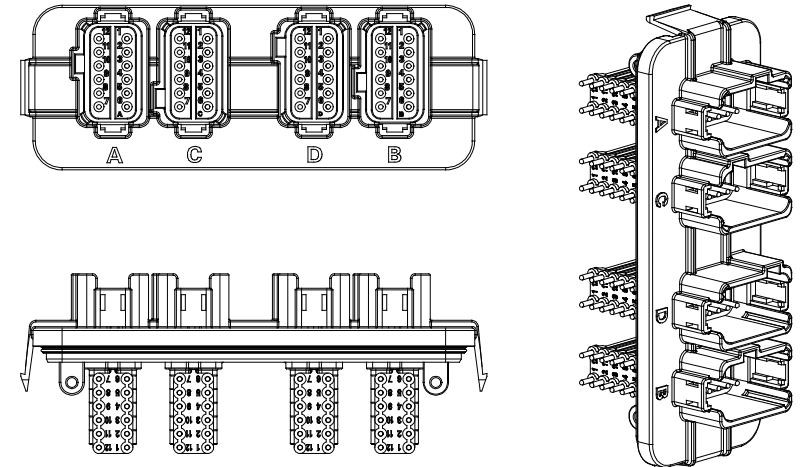

KEY A B C D

AT13-48PABCD-XXXX VARIANTS		
CONTACT PLATING	PART NUMBER	REFERENCE
GOLD	AT13-48PABCD-BM01	DT13-48PABCD-GR02
TIN	AT13-48PABCD-BM03	DT13-48PABCD-R015

AT13-XPX-XXXX		DESCRIPTION		ITEM
QUANTITY	PART NUMBER	MATERIALS LIST		
UNLESS OTHERWISE SPECIFIED 1) All dimensions are in metric(mm). 2) Tolerances are as follows: 1 PL DEC ±0.30 2 PL DEC ±0.15 3 PL DEC ±0.08 Fractions ±1/64 Angles ±1° 3) Note reference =		SIGNATURES DATE DRAWN: ZENIN DENG 13DEC19 CHECKED: ORION LI 13DEC19 ENGINEER: APPROVAL: TOMMY XIE 13DEC19 CUSTOMER:		Amphenol Sine Systems - www.amphenol-sine.com 44724 Morley Drive Clinton Township, MI 48036
MATERIAL SPECIFICATIONS: PROCESS SPECIFICATIONS: NEXT ASSY:		THIS DRAWING IS SUPPLIED FOR INFORMATION ONLY. DESIGN FEATURES, SPECIFICATIONS AND PERFORMANCE DATA SHOWN HEREON ARE THE PROPERTY OF THE AMPHENOL CORPORATION. NO RIGHTS OF REPRODUCTION ARE IMPLIED. ALL DIMENSIONS ARE SUBJECT TO NORMAL MANUFACTURING VARIATIONS.		
		SIZE TYPE DWG NO. B C- AT13-XPX-XXXX	REVISION A1	SCALE: NONE SHEET 3 OF 3

TITLE: ARMOR IPX RECEPTACLE AT HEADER, 4 X 12POS, 16# SIZE PIN
 DWG NO.: AT13-XPX-XXXX
 REV: A1
 SH: 3
 OF: 3

X-ON Electronics

Largest Supplier of Electrical and Electronic Components

Click to view similar products for [Automotive Connectors](#) category:

Click to view products by [Amphenol](#) manufacturer:

Other Similar products are found below :

[003-018-000](#) [60403001](#) [60993906-B](#) [M902-2131](#) [M902-2161](#) [72.330.1035.1](#) [73.353.4028.0](#) [F119300-B](#) [F166900](#) [F258300-B](#) [F358300-B](#)
[F407400](#) [F444110](#) [F487000](#) [F509500B-B](#) [827153-1](#) [8N1515-32-24P](#) [9-1326729-8](#) [925474-1](#) [928905-1](#) [964562-4](#) [968782-1](#) [GT17SA-8DS-](#)
[HU](#) [98891-1012](#) [98947-1016](#) [12004475-L](#) [12010290](#) [12010309-B](#) [12015454](#) [12020219-B](#) [12020308](#) [12041318-B](#) [12052225-L](#) [12052466](#)
[12059125](#) [12064869](#) [12004327-B](#) [12010503-B](#) [12015308](#) [12015384](#) [12015909](#) [1-21030-1](#) [12041254](#) [12041318](#) [12047946-B](#) [12047957](#)
[12047957-L](#) [12059473](#) [12066261](#) [12110546](#)