

REVISIONS					
REV	ECO	DESCRIPTION	DATE	BY	APPR
A1	-	RELEASE NEW DRAWING	19JUN18	JONY	TOMMY
A2	-	REVISED DRAWING	10JUL20	JHEAD	DH

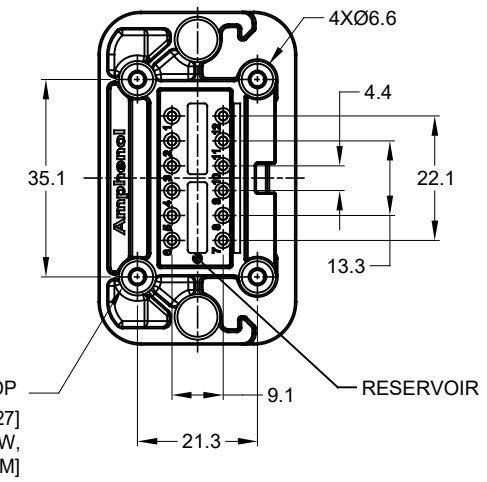

4xØ2.79±0.12 x8.0 DP
RECOMMENDED SCREW: 4-20 [M3.12 x 1.27]
THREAD-FORMING SCREW,
TORQUE:6-10 IN-LB [0.68-1.13 NM]

NOTES: UNLESS OTHERWISE SPECIFIED

- MATERIAL:
HOUSING: THERMOPLASTIC
SEAL: SILICONE RUBBER
CONTACT: COPPER ALLOY
- MODIFICATIONS: FLANGE, PCB MOUNT STRAIGHT
- SPECIFICATIONS:
3.1 CURRENT RATING: 13 AMPS
3.2 OPERATING TEMPERATURE: -55°C TO +125°C
3.3 DIELECTRIC WITHSTANDING VOLTAGE: LESS THAN 2 MILLIAMPS CURRENT LEAKAGE @ 1500 VOLTS AC.
3.4 INSULATION RESISTANCE: 1000 MEGOHMS MIN @ 25°C.
3.5 MOISTURE RESISTANCE: IP67 (MATED CONDITION)
3.6 MATING CYCLE DURABILITY: 100 CYCLES
3.7 RoHS COMPLIANT
- MATING PART: AT06-12S* PLUG (* = MODIFICATIONS)
- ALL DIMENSIONS ARE FOR REFERENCE USE ONLY.
- POTTED CONNECTORS SPECIFIED FOR UP TO 5 P.S.I. APPLICATIONS.

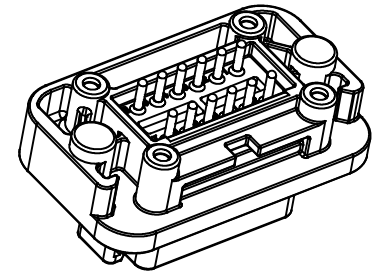
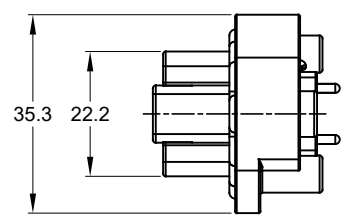

AT15-12PX-BMXX		REF: DT15-12PA, DT15-12PB, DT15-12PC, DT15-12PD, DT15-12PA-G003, DT15-12PB-G003, DT15-12PC-G003, DT15-12PD-G003, DT15-12PA-B028, DT15-12PB-B028, DT15-12PC-B028, DT15-12PD-B028	
PART NUMBER		DESCRIPTION	
QUANTITY	MATERIALS LIST		
UNLESS OTHERWISE SPECIFIED: 1) All dimensions are in metric (mm). 2) Tolerances are as follows: 1 PL DEC ±0.30 2 PL DEC ±0.15 3 PL DEC ±0.08 3) Note reference = Δ		SIGNATURES	DATE
MATERIAL SPECIFICATIONS:		DRAWN: JONY XIE	19JUN18
PROCESS SPECIFICATIONS:		CHECKED: ORION LI	19JUN18
NEXT ASSY:		ENGINEER:	
		APPROVAL: TOMMY XIE	19JUN18
		CUSTOMER:	
		THIS DRAWING IS SUPPLIED FOR INFORMATION ONLY. DESIGN FEATURES, SPECIFICATIONS AND PERFORMANCE DATA SHOWN HEREON ARE THE PROPERTY OF THE AMPHENOL CORPORATION. NO RIGHTS OF REPRODUCTION ARE IMPLIED. ALL DIMENSIONS ARE SUBJECT TO NORMAL MANUFACTURING VARIATIONS.	
SIZE	TYPE	DWG NO:	REVISION
B	C-	AT15-12PX-BMXX	A2
SCALE	NONE		SHEET 1 OF 3

TITLE: PCB MOUNT RECEPTACLE 12PIN STRAIGHT AT SERIES
DWG NO: AT15-12PX-BMXX
REV: A2
SH: 1
OF: 3

REVISIONS					
REV	ECO	DESCRIPTION	DATE	BY	APPR
A1	--	RELEASE NEW DRAWING	19JUN18	JONY	TOMMY
A2	--	REVISED DRAWING	10JUL20	JHEAD	DH

P/N AT15-12PA-BMXX
KEY-A CONFIGURATION
STANDARD COLOR: GREY

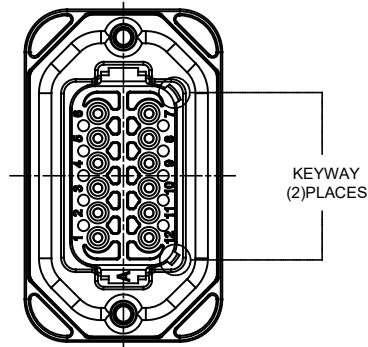

P/N AT15-12PB-BMXX
KEY-B CONFIGURATION
STANDARD COLOR: BLACK

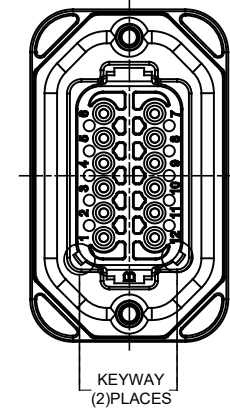

AT15-12PA-BMXX VARIANTS		
CONTACT PLATING	POTTING OR NOT IN RESERVOIR	PART NUMBER
GOLD	NO POTTING	AT15-12PA-BM01
GOLD	POTTING	AT15-12PA-BM02
TIN	NO POTTING	AT15-12PA-BM03
TIN	POTTING	AT15-12PA-BM04

AT15-12PB-BMXX VARIANTS		
CONTACT PLATING	POTTING OR NOT IN RESERVOIR	PART NUMBER
GOLD	NO POTTING	AT15-12PB-BM01
GOLD	POTTING	AT15-12PB-BM02
TIN	NO POTTING	AT15-12PB-BM03
TIN	POTTING	AT15-12PB-BM04

AT15-12PX-BMXX		DESCRIPTION		ITEM
QUANTITY	PART NUMBER			
MATERIALS LIST				
<small>UNLESS OTHERWISE SPECIFIED</small> 1) All dimensions are in metric(mm). 2) Tolerances are as follows: 1 PL DEC ±0.30 2 PL DEC ±0.15 3 PL DEC ±0.08 3) Note reference = Δ		<small>SIGNATURES</small> DRAWN: JONY XIE 19JUN18 CHECKED: ORION LI 19JUN18 APPROVAL: TOMMY XIE 19JUN18 <small>DATE</small>		Amphenol Sine Systems - www.amphenol-sine.com 44724 Morley Drive Clinton Township, MI 48036
<small>MATERIAL SPECIFICATIONS:</small> THIS DRAWING IS SUPPLIED FOR INFORMATION ONLY. DESIGN FEATURES, SPECIFICATIONS AND PERFORMANCE DATA SHOWN HEREON ARE THE PROPERTY OF THE AMPHENOL CORPORATION. NO RIGHTS OF REPRODUCTION ARE IMPLIED. ALL DIMENSIONS ARE SUBJECT TO NORMAL MANUFACTURING VARIATIONS.		<small>CUSTOMER:</small> BOARDLOCK PCB MOUNT RECEPTACLE, 12 PIN, STRAIGHT, AT SERIES		
<small>PROCESS SPECIFICATIONS:</small> NEXT ASSY:		<small>SIZE</small> B C-	<small>DWG NO.</small> AT15-12PX-BMXX	<small>REVISION</small> A2
		<small>SCALE</small> NONE	<small>SHEET</small> 2	<small>OF</small> 3

TITLE: PCB MOUNT RECEPTACLE, 12PIN, STRAIGHT, AT SERIES
DWG NO: AT15-12PX-BMXX
REV: A2
SH: 2
OF: 3

REVISIONS					
REV	ECO	DESCRIPTION	DATE	BY	APPR
01	--	RELEASE NEW DRAWING	19JUN18	JONY	TOMMY
A2	--	REVISED DRAWING	10JUL20	JHEAD	DH

P/N AT15-12PC-BMXX
KEY-C CONFIGURATION
STANDARD COLOR: GREEN

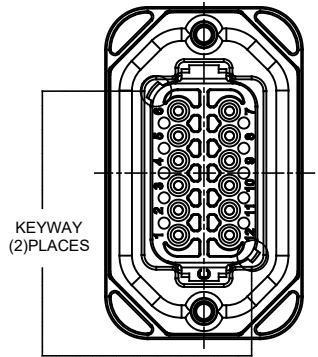

KEYWAY
(2)PLACES

P/N AT15-12PD-BMXX
KEY-D CONFIGURATION
STANDARD COLOR: BROWN

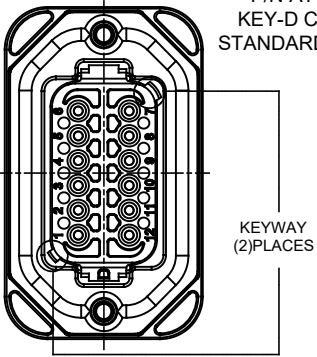

KEYWAY
(2)PLACES

AT15-12PC-BMXX VARIANTS		
CONTACT PLATING	POTTING OR NOT IN RESERVOIR	PART NUMBER
GOLD	NO POTTING	AT15-12PC-BM01
GOLD	POTTING	AT15-12PC-BM02
TIN	NO POTTING	AT15-12PC-BM03
TIN	POTTING	AT15-12PC-BM04

AT15-12PD-BMXX VARIANTS		
CONTACT PLATING	POTTING OR NOT IN RESERVOIR	PART NUMBER
GOLD	NO POTTING	AT15-12PD-BM01
GOLD	POTTING	AT15-12PD-BM02
TIN	NO POTTING	AT15-12PD-BM03
TIN	POTTING	AT15-12PD-BM04

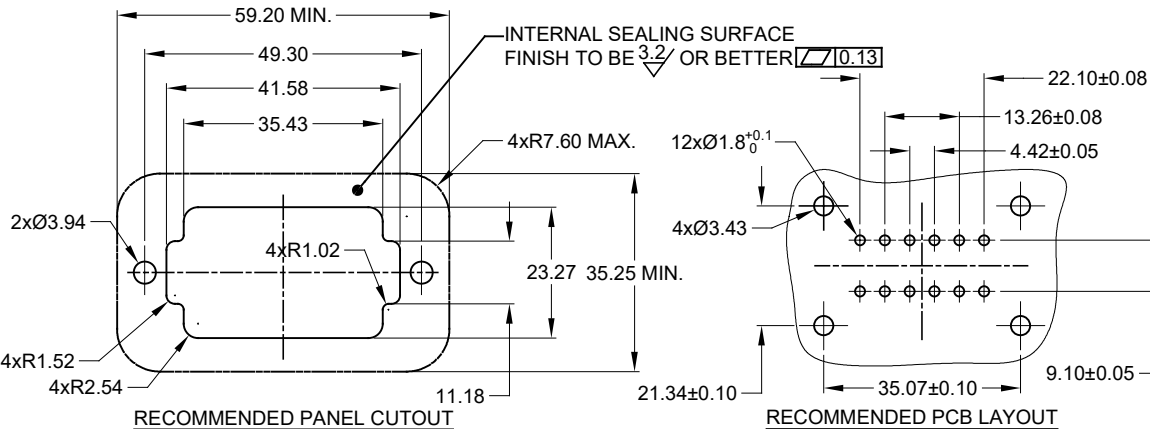

RECOMMENDED PANEL CUTOUT

RECOMMENDED PCB LAYOUT

AT15-12PX-BMXX		DESCRIPTION		ITEM
QUANTITY	PART NUMBER	MATERIALS LIST		
UNLESS OTHERWISE SPECIFIED		SIGNATURES	DATE	
1) All dimensions are in metric (mm).		DRAWN: JONY XIE	19JUN18	
2) Tolerances are as follows:		CHECKED: ORION LI	19JUN18	
1 PL DEC ±0.30		ENGINEER:		
2 PL DEC ±0.15		APPROVAL: TOMMY XIE	19JUN18	
3 PL DEC ±0.08		CUSTOMER:		
3) Note reference = Δ		THIS DRAWING IS SUPPLIED FOR INFORMATION ONLY. DESIGN FEATURES, SPECIFICATIONS AND PERFORMANCE DATA SHOWN HEREON ARE THE PROPERTY OF THE AMPHENOL CORPORATION. NO RIGHTS OF REPRODUCTION ARE IMPLIED. ALL DIMENSIONS ARE SUBJECT TO NORMAL MANUFACTURING VARIATIONS.		
MATERIAL SPECIFICATIONS:		Sine Systems - www.amphenol-sine.com 44724 Morley Drive Clinton Township, MI 48036		
PROCESS SPECIFICATIONS:		BOARDLOCK PCB MOUNT RECEPTACLE, 12 PIN, STRAIGHT, AT SERIES		
NEXT ASSY:		SIZE	TYPE	DWG NO.
		B	C-	AT15-12PX-BMXX
		SCALE	NONE	REVISION
				A2
				SHEET 3 OF 3

TITLE: PCB MOUNT RECEPTACLE, P/N STRAIGHT, AT SERIES
DWG NO: AT15-12PX-BMXX
REV: A2
SH: 3
OF: 3

X-ON Electronics

Largest Supplier of Electrical and Electronic Components

Click to view similar products for [Automotive Connectors](#) category:

Click to view products by [Amphenol](#) manufacturer:

Other Similar products are found below :

[003-018-000](#) [60403001](#) [60993906-B](#) [M902-2131](#) [M902-2161](#) [72.330.1035.1](#) [73.353.4028.0](#) [F119300-B](#) [F166900](#) [F258300-B](#) [F358300-B](#)
[F407400](#) [F444110](#) [F487000](#) [F509500B-B](#) [827153-1](#) [8N1515-32-24P](#) [9-1326729-8](#) [925474-1](#) [928905-1](#) [964562-4](#) [968782-1](#) [GT17SA-8DS-](#)
[HU](#) [98891-1012](#) [98947-1016](#) [12004475-L](#) [12010290](#) [12010309-B](#) [12015454](#) [12020219-B](#) [12020308](#) [12041318-B](#) [12052225-L](#) [12052466](#)
[12059125](#) [12064869](#) [12004327-B](#) [12010503-B](#) [12015308](#) [12015384](#) [12015909](#) [1-21030-1](#) [12041254](#) [12041318](#) [12047946-B](#) [12047957](#)
[12047957-L](#) [12059473](#) [12066261](#) [12110546](#)